

NEW EQUALIZERS FOR ANTIPROTON STOCHASTIC COOLING AT FERMILAB *

Ding Sun, Valeri Lebedev, Ralph J. Pasquinelli, Fermilab, Batavia, Illinois, USA

Abstract

In the continuous effort to improve antiproton stacking rate, a new type of equalizers has been developed and installed in antiproton accumulator. The R&D of these new equalizers is described in this paper.

INTRODUCTION

Equalizers are used in Fermilab antiproton stochastic cooling to compensate frequency response of the cooling system. Usually both amplitude and phase compensations are needed. However in most cases it is difficult to achieve a satisfactory compensation for both because of their interdependency. To make it more difficult is that in some cases large compensations (10 to 20 db of amplitude compensation or more than 100 degree of phase compensation) are needed near the low or high ends of a frequency band. Recently a new compensation scheme of equalizers is proposed for Fermilab antiproton accumulator. This scheme originated from the requirement to maximize the system performance resulting in a request for the phase of the cooling system transfer function to be extremely flat. For this kind of phase correction, a new type of equalizers has been developed.

NEW EQUALIZERS

The feature of this new type of equalizer is that it consists of two separate parts: the phase equalizer and the amplitude equalizer. Each part is made and tuned separately. The function of the phase equalizer is to correct only the phase. Then the amplitude equalizer corrects the amplitude (including the distortion caused by the phase equalizer part) to a desired shape. This approach not only makes the equalizer perform as required but also increases the adjustability of the equalizer. Each equalizer part can be categorized as a transversal or analog FIR (Finite Impulse Response) filter, though the FIR filter design algorithm was not followed during design of these filters. Shown in Fig. 1 is a schematic of one of these new equalizers.

The phase equalizer part of the new equalizer consists of power splitters, two or more two-port low-Q resonant circuit components, attenuators and delay lines. Shown between point A and B in Fig. 1 is a schematic of a phase equalizer part consisting of three resonant components. The input signal is first split into several signals.

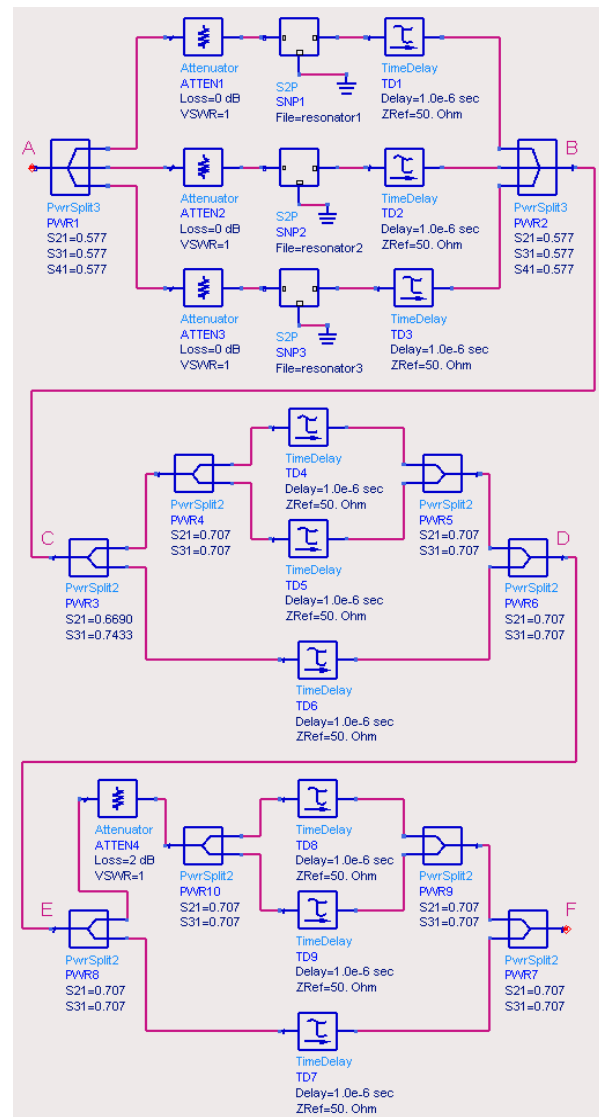

Figure 1: Schematic of a new equalizer.

Then the split signals are attenuated to various levels and fed into resonant components. After the resonant components, the split signals are recombined with various delay time for each sub-signal. Parameters of each individual circuit component such as resonant frequency, Q, attenuation, and delay time are used to control the location and slope of the phase change. Resonant components in Fig. 1 are implemented with parallel coupled microstrip (or stripline) lines. Shown in Fig. 2 is one of such resonant components. Other structures can also be used as long as they can generate desired phase change. To shorten R&D time, commercial power

*Work supported by Fermi Research Alliance under contract to the US Department of Energy.

splitters (combiners) with equal split ratio and attenuators are used as shown in Fig. 1. However, they can be replaced with a splitter of unequal split ratio to make the phase equalizer part more compact (as long as the split ratio is not too large to be implemented). Shown in Fig. 3 and 4 are the measured phase and amplitude of a phase equalizer part. This phase equalizer part has five resonant components (five boxes shown in Fig. 7). The more resonant components are used, the finer phase correction can be achieved.

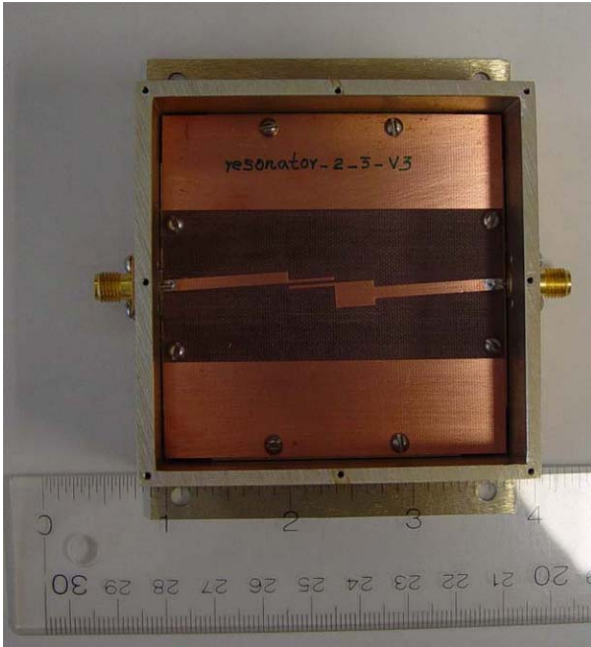

Figure 2: A resonant component.

The amplitude equalizer part is essentially one or more low-Q notch filters which “corrects” (compensates) amplitude of original transfer function plus the amplitude distortion caused by the phase equalizer part to a desired shape while keeping phase unchanged. Each notch filter consists of four splitters/combiners, attenuators and delay lines of various lengths. Shown between point C and F in Fig.1 is the amplitude equalizer part which has two units: between C and D and between E and F. In the unit between C and D, the input signal is first split unequally. One of the split signals is split again and recombined with different delay times. Then the two signals are combined again with different delay times. The first split ratio controls the depth of the notch and the difference between delay times control the location of the notch and flatness of the phase. The unit between E and F is similar to the one between C and D. The only difference is that the unequal splitter is replaced with an equal splitter and an attenuator. The more of these units are used, the finer amplitude correction can be achieved. Shown in Fig. 5 and 6 are measured amplitude and phase of an amplitude equalizer part (single unit). This amplitude equalizer part is shown in Fig. 7 alongside the phase equalizer part (five boxes).

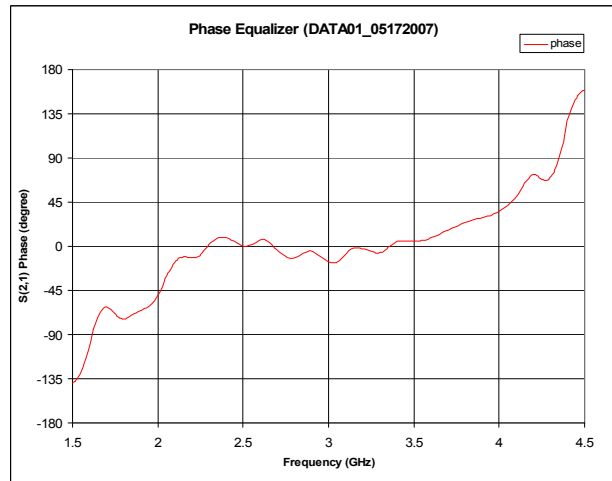

Figure 3: Phase of a phase equalizer part.

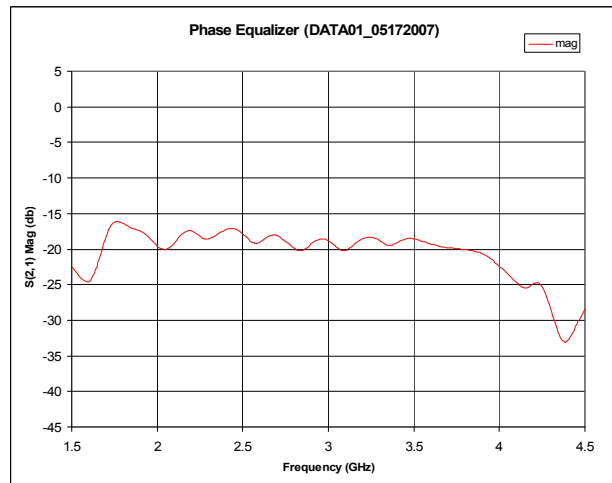

Figure 4: Amplitude of a phase equalizer part.

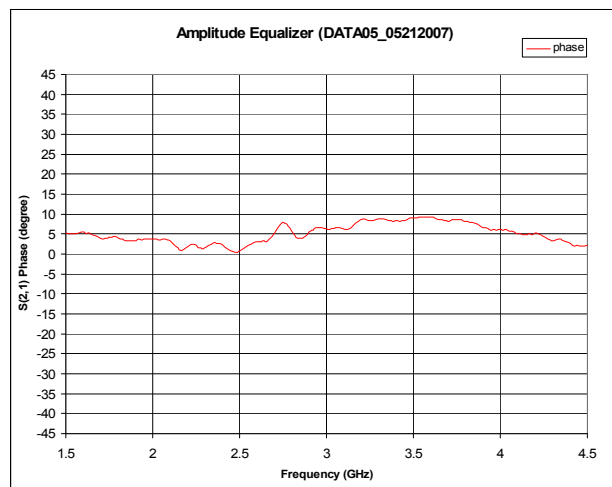

Figure 5: Phase of an amplitude equalizer part.

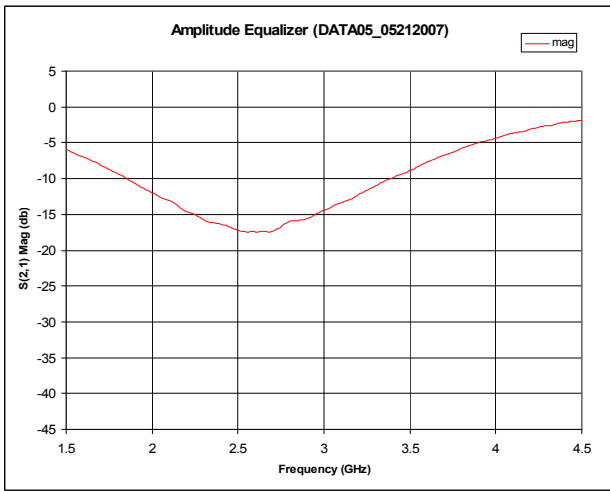

Figure 6: Amplitude of an amplitude equalizer part.

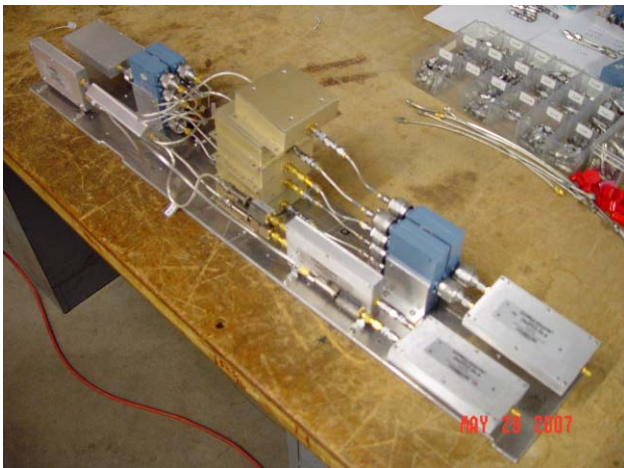

Figure 7: Assembly of a new equalizer.

Shown in Fig. 7 is an assembly of a new equalizer with the phase equalizer part (five resonant components) and amplitude equalizer part (single unit) described in the previous sections. The measured phase and amplitude of system transfer function with this equalizer versus the one without this equalizer are shown in Fig. 8 and 9. The goal is to flatten the phase between 1.75 GHz and 4.25 GHz. (Note: the amplitude part does not need to be flat up to 4.25 GHz due to heating problem generated by noise in that frequency region). This equalizer has been put in use in stacktail system and cooling rate has been improved by 5-10% [1]. Shown in Fig. 10 and 11 are the gain of the stacktail system before and after the installation of a new equalizer. A similar equalizer has been built and installed in core 4 – 8 GHz momentum system (Fig. 12).

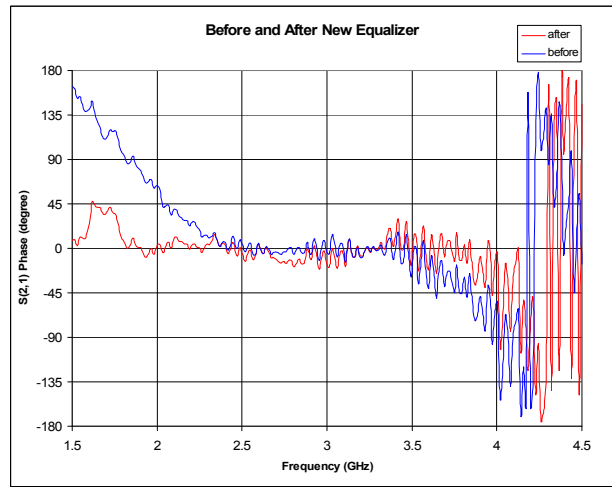

Figure 8: Phase of transfer function before and after installation of an equalizer.

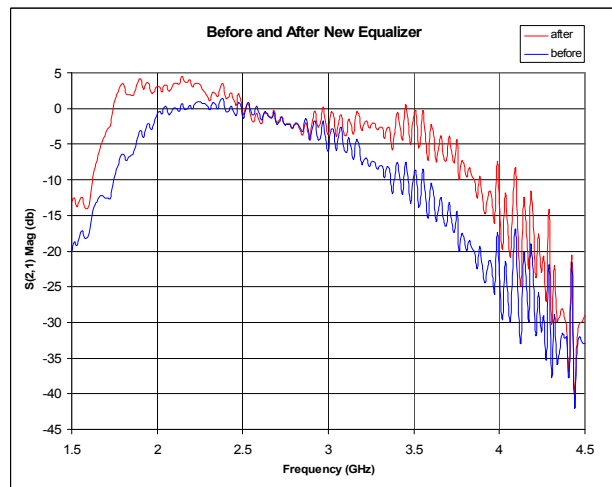

Figure 9: Amplitude of transfer function before and after installation of an equalizer.

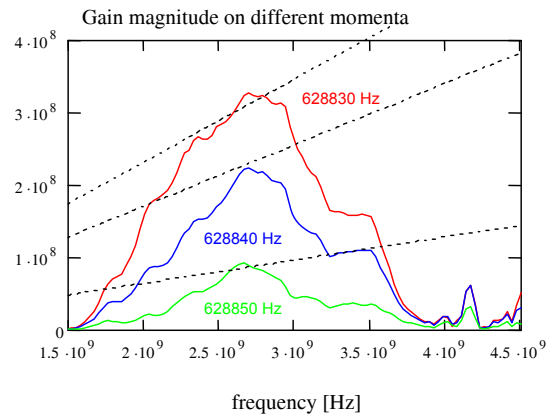

Figure 10: Stacktail gain before installation of an equalizer.

REFERENCES

- [1] Valeri Lebedev, "Antiproton Production and Accumulation", Proceedings of this Workshop.

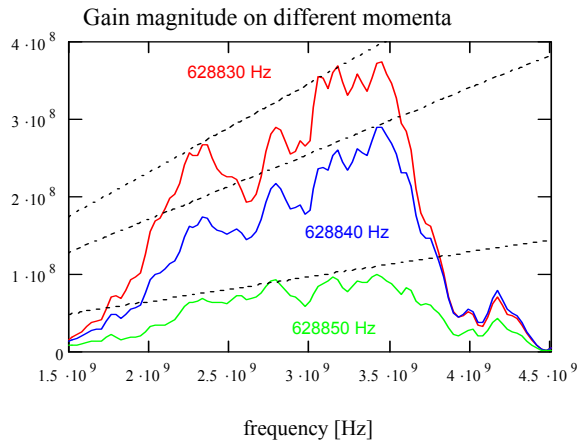

Figure 11: Stacktail gain after installation of an equalizer.



Figure 12: A new equalizer installed in core 4-8 GHz momentum system.