

Final Technical Report  
June 24, 2008

DE-FG36-04GO14246  
Maine Technology Institute  
“Maine Forest Bioproducts Research and Development”

Project Manager: Martha Bentley

Project Partners:  
River Valley Growth Council, Scott Christiansen, lead  
University of Maine, Michael Bilodeau, lead  
Maine BioProducts, Paul Nace, lead  
Tethys Research, Nancy Kravit, lead

NOTICE OF PROPRIETARY INFORMATION: Information within TASK B contributed by University of Maine contains proprietary information.

### **Executive Summary**

Purpose - The Maine Forest Bioproducts Research and Development project originally focused on the State’s interest in the development of an integrated forest products refinery (IFPR). The original intent was that Research and Development (R&D) funded by this award will allow Maine to refine its strategy and pursue development of an integrated biorefinery.

Scope - Activities were to be divided into three major R&D projects: (a) Establish the potential for a forest products biorefinery in Maine, by determining the technical and economic feasibility and resource availability. (b) Investigate and develop conversion processes for forest bioproducts to utilize the sugars available from hemicellulose. Research projects will determine how to best utilize refinery waste streams to recover heat value and recycle remaining components. (c) Cost share very early stage R&D efforts to engage the private sector and stimulate innovative efforts that will build upon the research efforts in (b) above, utilize the information gleaned from (a), and lead to commercialization of new products or services and development of the forest bioproducts industrial sector in Maine.

Tasks and Participants – The project was divided into three major task areas, to be managed by the three primary project partners. Project partners completed all three tasks successfully, but with mixed results on the final use of the information gained through the process.

- Task A: River Valley Growth Council produced a comprehensive biorefinery feasibility study report for the State of Maine, with concentration on the river valley region of Western Maine. The report included a biorefinery feasibility

survey, a market student for fine chemical and fuel additive output products on a national scale with a New England sub-analysis, and a market study of H<sub>2</sub> use and H<sub>2</sub> production in northern New England, including trend analysis, with comparison to projected costs of biorefinery-produced H<sub>2</sub> in northern New England.

- Task B: The University of Maine, Department of Chemical and Biological Engineering and Pulp and Paper Process Development Center completed work that included identifying current industrial practices, process design and economic analysis, as well as early-stage research on hemicellulose separation technology and hemicellulose conversion technology.
- Task C: The Maine Technology Institute cost-shared four projects in the area of forest bioproducts research and development in an effort to engage the private sector in Maine in early-stage research and development that could lead to commercialization of new products or processes. These projects were selected using MTI's established, open and competitive review process. Two of the four projects received multiple rounds of funding to pursue their individual projects.

#### Results –

- Task A: Although the studies were completed successfully with at least qualified GOs in each area of study, the project partner overseeing this work has experienced significant organizational transitions with the result being a current leadership vacuum. At this writing, there is a virtual standstill in efforts in the River Valley region in forest bioproducts refinery development based on this report. That said, when the report was first released, it generated significant public interest and traffic to the RVGC website, and as oil prices continue to climb, the study report will likely be revisited by other organizations looking to further develop the forest biofuels area. In addition, the decision to expand the siting survey portion of the study allows it to be useful for biorefinery development in areas of the State other than the River Valley region.
- Task B: The early-stage R&D completed under Task B has led to further project development for the University of Maine and its commercial partners. An innovative partnership involving University of Maine, Red Shield Environmental and American Process Incorporated has been awarded a grant of up to \$30 million from the US Department of Energy to design, build and operate a small scale commercial biorefinery. This biorefinery will produce ethanol, acetic acid and other by-products along with market pulp in the RSE Pulp & Chemical's existing mill located in Old Town, Maine. The fermentation work and techno-economic analysis conducted under Task B were major components in the grant proposal leading to this highly competitive \$30 million award.
- Task C: Task C was a process-oriented task, allowing MTI to cost-share early R&D efforts with the US Department of Energy and the companies pursuing commercialization of forest bioproducts. MTI used a competitive process that included peer and financial review to provide awards to four companies, two of whom ended projects when NO-GOs were hit, and two of whom were awarded second contracts based on successful completion of milestones of initial project

contracts. As of this writing, these two projects are on-going and continue to meet more sophisticated project milestones.

In summary, all project tasks were completed, with the result being at least incremental movement towards development of an integrated forest products refinery, as well as promising development in the overall forest bioproducts sector in the state of Maine.

### **Comparison of Accomplishments with Goals and Objectives**

Goals: Goals were divided into three major R&D projects: (a) Establish the potential for a forest products biorefinery in Maine, by determining the technical and economic feasibility and resource availability. (b) Investigate and develop conversion processes for forest bioproducts to utilize the sugars available from hemicellulose. Research project objectives include determining how to best utilize refinery waste streams to recover heat value and recycle remaining components. (c) Cost share very early stage R&D efforts to engage the private sector and stimulate innovative efforts that will build upon the research efforts in (b) above, utilize the information gleaned from (a), and lead to commercialization of new products or services and development of the forest bioproducts industrial sector in Maine.

The above-listed goals led to the establishment and completion of three major objectives:

- Task A: River Valley Growth Council produced a comprehensive biorefinery feasibility study report for the State of Maine, with concentration on the river valley region of Western Maine. The report included a biorefinery feasibility survey, a market study for fine chemical and fuel additive output products on a national scale with a New England sub-analysis, and a market study of H<sub>2</sub> use and H<sub>2</sub> production in northern New England, including trend analysis, with comparison to projected costs of biorefinery-produced H<sub>2</sub> in northern New England. The study was originally limited in scope to the Western Maine river valley region, but was able to be expanded to include more of the State, and the final product including analysis of multiple siting possibilities.

Although the studies were completed successfully with at least qualified GOs in each area of study, the project partner overseeing this work has experienced significant organizational transitions with the result being a current leadership vacuum. At this writing, there is a virtual standstill in efforts in the River Valley region in forest bioproducts refinery development based on this report. That said, when the report was first released, it generated significant public interest and traffic to the RVGC website, and as oil prices continue to climb, the study report will likely be revisited by other organizations looking to further develop the forest biofuels area. In addition, the decision to expand the siting survey portion of the study allows it to be useful for biorefinery development in areas of the State other than the River Valley region.

- Task B: The University of Maine, Department of Chemical and Biological Engineering and Pulp and Paper Process Development Center completed work that included identifying current industrial practices, process design and economic analysis, as well as early-stage research on hemicellulose separation technology and hemicellulose conversion technology.

The early-stage R&D completed under Task B has led to further project development for the University of Maine and its commercial partners. An innovative partnership involving University of Maine, Red Shield Environmental and American Process Incorporated has been awarded a grant of up to \$30 million from the US Department of Energy to design, build and operate a small scale commercial biorefinery. This biorefinery will produce ethanol, acetic acid and other by-products along with market pulp in the RSE Pulp & Chemical's existing mill located in Old Town, Maine. The fermentation work and techno-economic analysis conducted under Task B were major components in the grant proposal leading to this highly competitive \$30 million award.

- Task C: The Maine Technology Institute cost-shared four projects in the area of forest bioproducts research and development in an effort to engage the private sector in Maine in early-stage research and development that could lead to commercialization of new products or processes. These projects were selected using MTI's established, open and competitive review process. Two of the four projects received multiple rounds of funding to pursue their individual projects.

Task C was a process-oriented task, allowing MTI to cost-share early R&D efforts with the US Department of Energy and the companies pursuing commercialization of forest bioproducts. MTI used a competitive process that included peer and financial review to provide awards to four companies, two of whom ended projects when NO-GOs were hit, and two of whom were awarded second contracts based on successful completion of milestones of initial project contracts. As of this writing, these two projects are on-going and continue to meet more sophisticated project milestones. MTI and DOE early investment in these two projects has led both to additional public and private investment. As a process task, Task C was a success. MTI's portfolio approach led to a to-be-expected outcome of two projects ending and two projects continuing with additional support. This outcome clearly demonstrates the continued need for public funding of promising, but early-stage R&D efforts. The two technologies explored in the prematurely ended projects proved not to be economically viable when one or two small variables changed.

- Task D: As part of its efforts to help refine the State's approach to development of an integrated forest bioproducts refinery and the further development of the forest bioproducts sector, MTI used its participation in this DOE-funded project as an opportunity to establish a Forest Bioproducts Working Group, made up of organizations funded through this project grant and others working in forest bioproducts area. This group met quarterly throughout the life of the grant

project, and continues to meet currently on an informal basis. This opportunity to share lessons learned and network has been an invaluable byproduct of this project.

### **Summary of Project Activities**

#### Task A - Biorefinery feasibility R&D:

This task was broken into three sub-tasks leading to three detailed documents reporting on the feasibility of establishing a biorefinery in Western Maine: a biorefinery feasibility survey, a market study for fine chemical and fuel additive output products on a national scale with a New England sub-analysis, and a market study of H2 use and H2 production in northern New England, including trend analysis, with comparison to projected cost of biorefinery-produced H2.

River Valley Growth Council staff completed sub-task one, a biorefinery feasibility survey, original specific to Western Maine. This survey included the following elements:

- Develop input/output model, conduct siting survey and analysis, develop cost and availability model of local/regional sustainable biomass supply: topics covered and questions answered are listed below:
  1. If no site is available in the River Valley to accommodate a full-scale biorefinery, NO-GO. If NO-GO, a broader search in western Maine will be conducted until an acceptable site is identified. Go. Acceptable sites in the River Valley have been identified and, in addition, a number of other sites in the state have been closely surveyed and evaluated.
  2. If sustainable biomass availability within a 50 mile radius of Rumford is less than 1000 tons/day, NO-GO. If NO-GO, radius will be increased to 75 miles. If 1000 tons/day is not available at 75 miles, availability is NO-GO and an alternate site will be chosen and evaluated. Go. It has been determined that there is more than 1000 t/day biomass available within 50 miles of Rumford on a sustainable basis, especially with the closure of the Berlin paper mill during the course of this effort.
  3. If sustainable biomass is forecast to trend above \$60 a dry ton in the next five years, NO-GO. If NO-GO, biomass cost will be analyzed assuming some substitution of biomass hog fuel with STF (shredded tire fuel), and the impact the substitution will have on cost and availability. If still NO-GO, a regional cost analysis will be done to determine if lower-cost supply areas exist in Maine. If undertaken, these activities will be coordinated with Biomass Availability activities above. Go. Biomass is currently priced at around \$42 a dry ton. If the price rises to close to \$60 a dry ton, it becomes profitable to ship chips to Maine from South America, thus placing an effective ceiling near the \$60 price for the time.
  4. If biorefinery products cannot be profitably or safely transported to market in a timely manner, NO-GO. IF NO-GO, then a reformulation of product

line (with transport safety and market demand equally weighted) will be undertaken until a marketable and transportable product profile is determined. GO. The technical portion of the study has been completed and indicates specific products that can be made profitably (dependent on site-specific issues and decisions) and safely transported to market via either road or rail.

- Identify optimum technologies. GO. The technical portion of the market study is complete, and reveals paths in both pyrolysis and gasification, with an optimum path in pyrolysis followed by gasification and catalysis.
  1. If biomass harvesting infrastructure and activity is expected to contract by over 50% in the next five years, NO-GO. If NO-GO, areas of adequate harvesting activity in Maine will be identified in conjunction with the above activities. A qualified GO as biomass price trends and a return to longer-term contracts and increased demand has made harvesting more attractive. If current trends/conditions stay in place, harvesting is not expected to contract 50% in the next five years, but may instead expand. All of this is conditional and dependent upon the continued operation of paper mills in Maine, which provide significant demand for forest harvest and therefore contribute critically to the “critical mass” of harvest capacity.
- Develop profile of optimized biorefinery. With the completion of the technology and biorefinery design portions of the market study, this element is complete. The biorefinery optimized for current conditions (markets, products, technology) has been phased to achieve significant build-out and economic opportunity from several platforms that each address an existing market with an existing technology.
  1. If the emissions profile for a full-scale biorefinery exceeds current allowable Maine DEP or EPA standards, NO-GO. If NO-GO, the optimum technology route will be re-evaluated seeking a technology that meets or exceeds EDA/DEP emissions criteria. A qualified GO. Initial biorefinery platforms will involve making pyrolysis oil and converting it to heat and power, with fractionation of the higher-value components to bio-oil to follow. When pyrolysis oil is used to fuel a turbine, the emissions profile is comparable to natural gas, and as such there should be no problem in DEP or EPA permitting. However, there are no working commercial-scale examples to point to, so the GO must be qualified.
  2. If the availability of critically-skilled workers needed in the biorefinery is profoundly constricted, NO-GO. IF NO-GO, solutions will be sought via education partners such as U Maine in regard to the viability of increasing the supply of critically-skilled workers. GO, with laborers likely drawn from a national pool, perhaps at higher-than-market rates, and with the

caveat that a significant biorefinery sector in Maine may require an expanded training program for specific skills at U Maine. For the initial one or two biorefineries contemplated in this study, local mill-wright talent augmented by specific recruited talent will meet needs and can be attracted with at-market and above-market rates of compensation.

- Sub-task one also led to an addendum document, The Siting and Infrastructure Addendum, which profiled sites and provided sites and infrastructure analysis for multiple sites across the state of Maine.

Robert J. Evans, MicroChem Technologies, Inc. completed sub-task two, a market study for fine chemical and fuel additive output products on a national scale with a New England sub-analysis. This study was undertaken with the assumption that if there is not a viable (profitable) market for a mix of biorefinery products, NO-GO. If NO-GO, the project is proven unfeasible and remaining project funds would be returned to MTI. The study indicated a GO. The technology and market study portions of this study indicate that there are specific processes yielding specific products which are viable at current market rates including the first platform, pyrolysis and generation of heat and power.

Acadia Environmental Technology and The Chewonki Foundation completed sub-task three, a market study of H<sub>2</sub> use and H<sub>2</sub> production in northern New England, including trend analysis, with comparison to projected cost of biorefinery-produced H<sub>2</sub>.

#### Task B – Technology R&D:

Technology R&D was originally broken into four sub-tasks, but eventually two of the sub-tasks were essentially folded into one reporting mechanism. Original sub-tasks were: (a) investigation of current industrial practices; (b) Hemicellulose separation technology; (c) Hemicellulose conversion technology; (d) process design and economic analysis.

Joseph Genco, Haibo Mao, and Jay Mitchell completed work on sub-tasks (a) and (d). Work was performed in two areas and resulted in awarding two Master of Science degrees in chemical engineering<sup>1,2</sup>. Both projects compared and contrasted the technical economics of producing ethanol from wood. In the first project performed by Jay Mitchell considered producing ethanol and electrical energy from raw white wood. Secondly, a technical economic analysis was performed for the concomitant concept of extracting the hemicelluloses in the wood prior to pulping and then converting the extracted residue into Kraft pulp. The extracted hemicelluloses were converted into ethanol while acetyl groups on the hemicelluloses were cleaved and converted into acetic acid or “white vinegar”.

#### *Production of Ethanol from Northeast Hardwood by the NREL Process*

---

<sup>1</sup> Mitchell, J., “Production of Ethanol from Hardwood”, University of Maine M.S. Thesis, Orono, Maine (2006).

<sup>2</sup> Mao, H., “Technical Evaluation of a Hardwood Biorefinery Using the Near-Neutral Hemicellulose Extraction Process”, University of Maine M.S. Thesis, Orono, Maine (2007).

The thesis contains a very thorough review of process pathways for producing ethanol from biomass. The objective of the project conducted by Jay Mitchell was to perform a technical economic analysis of the hardwood to ethanol process using white wood by the NREL process. The National Renewable Energy Laboratory (NREL) process is the most advanced woody biomass to ethanol process currently available and consists of nine sections: feed handling and preparation, acid pre-treatment, sugar fermentation, cellulase generation, separations/distillation, waste treatment, ethanol storage, lignin burner/boiler/turbo generator, and utilities for the plant.

In this technical economic analysis a Greenfield plant was compared to co-locating the ethanol plant adjacent to a Kraft pulp mill. The advantage of the latter case is that facilities can be shared jointly for ethanol production and for the production of pulp. Preliminary process designs were performed for three cases; a base case size of 2205 dry tons/day of hardwood (52 million gallons of ethanol per year) as well as the two cases of half and double this size. The thermal efficiency of the NREL process was estimated to be approximately 36%; that is about 36% of the thermal energy in the wood is retained in the product ethanol and by-product electrical energy.

The discounted cash flow rate of return on investment and the net present value methods of evaluating process alternatives were used to evaluate the economic feasibility of the NREL process. The minimum acceptable discounted cash flow rate of return after taxes was assumed to be 10%. In all of the process alternatives investigated, the dominant cost factors are the capital recovery charges and the cost of wood. The Greenfield NREL process was found not to be economically viable. The cost of producing ethanol in 2006 U.S. currency was found to vary from \$2.58 to \$2.08/gallon for the half capacity and double capacity cases respectively.

For comparison to the Greenfield cases, three co-location scenarios were also considered. Case A involved citing the hardwood to ethanol plant is co-located at a pulp mill that already has a recovery boiler, burner, and turbo generator with excess unused capacity that can burn residual lignin and by-products from the ethanol fermentation process. In this case, it was assumed that the company building the ethanol plant also owned the pulp mill; therefore there would not be additional charges for using the boiler system and the installed cost of the burner/boiler/turbo generator section would be equal to zero. This case coincides with a pulp producer wishing to produce additional products besides pulp. Case B was exactly the same as Co-Location Case A except that the cellulase enzyme used to partially hydrolyze the cellulose was purchased from a cellulase supplier rather than produced on site. The installed equipment cost for the cellulase generation process became zero and cellulase was considered a raw material. Case C continues to build on the concept of Co-Location Case B and the facility was sited at a pulp mill that has additional waste treatment capacity and a wood yard that could handle the additional wood used as the ethanol feedstock.

The co-location cases appear more promising due to reductions in capital costs when compared to the Greenfield plant. The most profitable co-location case resulted in a discounted cash flow rate of return improving from 8.5% for the half capacity case to 20.3% for the double capacity case (Figure 1). Due to economy of scale, the investments become more and more profitable as the size of the plant increases. This concept is limited by the amount of wood that can be delivered to the plant on a sustainable basis as well as the demand for ethanol within a reasonable distance of the plant.



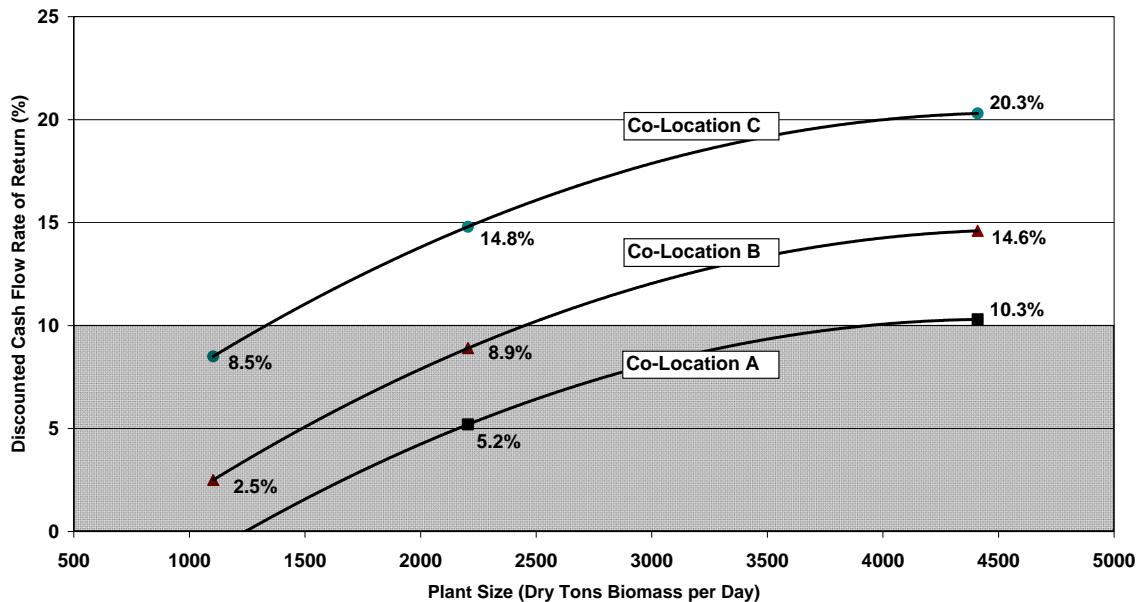


Figure 1. DCFROR as a Function of Plant Size for All Cases (EtOH Selling Price = \$2.50/gallon, Wood Cost = \$60/BD Ton, Discount Factor = 10%)

#### *Hardwood Biorefinery Using the “Near-Neutral Hemicellulose Extraction Process*

Haibo Mao performed a technical analysis for a new process that produces ethanol and acetic acid from hardwood in addition to bleached hardwood Kraft pulp. The new process, termed the “near neutral” hemicellulose extraction process, involves the extraction of wood hemicellulose using green liquor prior to conventional Kraft pulping. Based upon the results of Mitchell’s work<sup>1</sup>, Mao assumed that the new process was located at an existing Kraft pulp mill. Ancillary unit operations in the process include hydrolysis of the extracted carbohydrates using sulfuric acid, filtration of the extract to remove lignin that was extracted with the carbohydrates, liquid-liquid extraction of acetic acid and by-product furfural, liming of the hydrolyzed extract, separation of gypsum which is the product of the liming reaction, fermentation of C5 and C6 sugars and upgrading of the acetic acid and ethanol products by distillation. After the extraction step in the process, the final pH of the extraction liquor varies between 5 and 6 and preserves the yield and physical properties of the final pulp product which are equivalent to market Kraft pulp.

In Mao’s research<sup>2</sup>, a design model was developed using WinGEMS and ASPEN Plus software. The integrated mass and energy balances were obtained from the computer model and used to size important process equipment in the process. Information from the process model and the flow sheet were used to estimate capital and operating cost for the process. A major economic factor in the analysis is whether a new extraction vessel is required or if an existing digester can be retrofitted into a vessel suitable for the extraction. The economic analysis was performed as a function of the size of the pulp mill being retrofitted to accommodate the hemicellulose extraction process. Alternative cases that were evaluated considered whether the utilities and waste water treatment systems were sufficient to accommodate the new process. In the

economic analysis, the Discounted Cash Flow Rate of Return (DCFROR) was used to judge the economic merits of the new process (Figure 2). The rate of return on investment was found to vary between 7.1 and 13.0 percent depending upon the size of the pulp mill (750 to 1,500 tonne per day pulp production rate) for the case where the extraction vessel is available and the utilities and waste treatment facilities are sufficiently large to handle the additional requirements for the process. If a new extraction vessel must be purchased, the process is not economically justified regardless whether the utilities and waste water treatment facilities are sufficient to handle the new process.

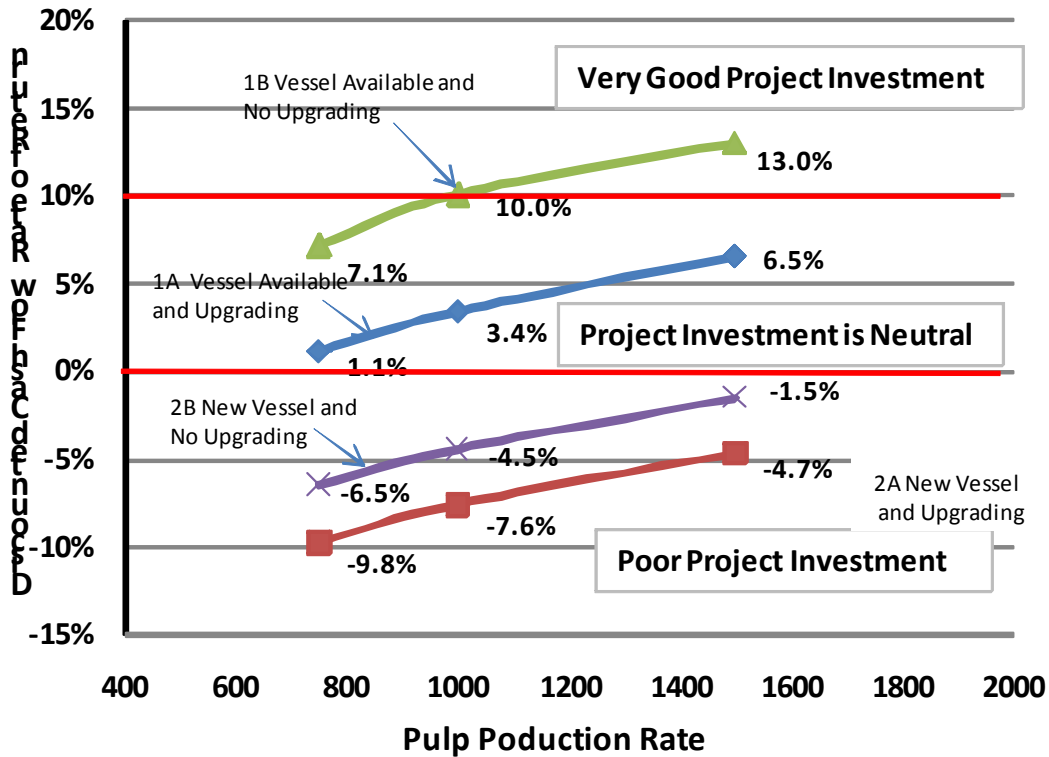


Figure 2. Discount Cash Flow Rate of Return for Different Case

A very important advantage of the “near-neutral” extraction process is that the recovery cycle is off-loaded because the amount of organic matter in the black liquor is reduced and less white liquor is needed for pulping. This change in operation would potentially allow a Kraft pulp mill to significantly increase its pulp production rate if the recovery cycle is the bottleneck in the plant. In the hemicellulose extraction process the methanol content of the black liquor is thought to be reduced by about 40%, while the TRS content is also diminished. These advantages result because of the lower white liquor charge and shorter pulping time during the modified Kraft cook. A major disadvantage of the process is that the production rates for the two co-products, ethanol and acetic acid, are low when compared to corn to ethanol processes. Less steam is produced in the recovery boiler because a portion of the organic matter in the wood chips is extracted. Consequently, additional steam must be supplied from a biomass boiler or by burning fossil fuels such as natural gas, coal or fuel oil. Lastly the near neutral extraction process is capital intensive unless an extraction vessel is available for use. The

high capital and operating costs result from the complexity of the process. To be economically viable, the process must be simplified considerably.

Stephen Shaler, Ph.D., Professor of Wood Science, Professor Adriaan van Heiningen, Ph.D., Professor of Chemical Engineering, Juan Paredes, Ph. D., Student, Wood Science, completed work on sub-task (b). Two extraction protocols were developed for Red Maple strands used to manufacture Oriented Strand Board (OSB). The procedures involved placing green strands in a pressure vessel at a liquid:solid ratio of 4:1. The charge was heated to 160 C (90 psig) in 50 minutes with a subsequent dwell time of either 45 or 90 minutes. These conditions removed 16.4% and 17.2% of the material. The influence of these extraction conditions on the properties of OSB made from those strands was determined. The 90 minute dwell time was too long as indicated by reductions in mechanical behavior of the panels. The shorter reaction time provided a mix of improvements (dimensional stability), no influence (flexural behavior), and degradation (wood/wood bond strength). It was postulated that this weight loss would also result in a significant reduction in VOC production. Baseline measurements of VOC emissions during OSB pressing of Southern Pine material were made. Due to a delay in the design and manufacture of a larger extractor vessel it was not possible to measure the influence of that extraction on VOC emissions. It is recommended that extraction times below 45 minutes be evaluated. Shorter process times would be less costly to implement industrially. Detailed investigations were made on the change in wood properties associated with the extraction conditions. The extractions created significant, fundamental changes in a wide spectrum of physical and mechanical characteristics including carbohydrate crystallinity, surface energy, cell wall porosity, hygroscopicity, and higher heat value.

A PhD student was supported by this project with two manuscripts produced to date.

Heller, J.J.P., S.M. Shaler, A. van Heiningen, and R. Jara. 2007. Influence of hemicellulose extraction on physical and mechanical behavior of OSB. Submitted Dec. 2007. Forest Products Journal

Heller, J.J.P., R. Mills, S.M. Shaler, D. J. Gardner, and A. van Heiningen. 2008. Surface characterization of red maple strands after hot water extraction. Submitted Feb. 2008. Wood and Fiber Science.

Adriaan van Heiningen, Professor and Ober Chair, and Sara Walton, University of Maine, Ph.D. graduate student completed work on sub-task (c). Following are summary results of research undertaken under sub-task (c).

As part of the integrated forest products bio-refinery, hemicelluloses may be extracted from woodchips prior to pulp production, generating a new stream which may be converted to chemicals or fuels such as ethanol. Hemicelluloses, once extracted, must be hydrolyzed to give a mixture of five and six carbon monosugars, of which xylose is the principal component in hardwoods. Many bacteria and yeast strains exist which will convert sugar into ethanol or a variety of other products, though most of these organisms

exclusively or preferentially ferment the six carbon glucose. To convert the five carbon xylose to ethanol, the fermentation organisms need to be specially engineered with new genes. One bacterium that has been engineered to convert xylose is *Escherichia coli* K011. This organism has been studied in fermentation experiments carried out in a 3L BioFlo110 fermentor from New Brunswick Scientific, looking for a set of conditions optimal for ethanol production. Biological processes such as fermentation must be closely monitored for proper pH, temperature, aeration, and agitation. Fermentative organisms can be inhibited by many growth conditions or chemicals, several of which are produced during acid hydrolysis of hemicelluloses. Acetyl groups released from the hemicellulose become acetic acid, which is known to interfere with cellular functions. Sodium, added during the extraction process in the form of sodium hydroxide, sodium carbonate and sodium sulfide, is also a known inhibitor of microbial growth. The sugar degradation products furfural and hydroxymethyl furfural are compounds of concern in fermentation. Hemicellulose extraction conditions and the conditions of hydrolysis can affect the amount of these substances produced, so we are attempting to minimize their production, while maximizing the monosugar content. Fermentation of pure sugars with and without inhibitors was compared to fermentation of the extracted hemicellulose liquor. Concentrations of substrates and products were measured over time by HPLC.

Mixed hardwood chips were extracted in green liquor, a solution created during pulping comprised of sodium carbonate, sodium sulfide, and sodium hydroxide, at 160°C for 110 minutes in a 10L rocking digester. The resulting liquid portion is mainly comprised of hemicellulose, acetate and sodium in a dilute solution. The hemicellulose polymers must be broken down into monosugars in order to be fermented. The initial extract, at 3% total solids content, contained approximately 5g/L monosugars, 10g/L acetic acid, and 5g/L sodium. In fermentation to ethanol the highest theoretical conversion is only 0.51 gram ethanol per gram of initial sugar, and it is economically unfavorable to distill the final product if the ethanol concentration is too low. It is therefore desired to have the highest possible concentration of monosugars before fermentation. To increase the amount of sugar in the hemicellulose extract, it was run through a thin film evaporator to remove water. Samples were concentrated to 6% and 10% solids. Evaporation increases the amount of sugar, but also increases the amount of acetic acid and sodium proportionally. Figure 1 shows the composition of the original extract compared to the concentrated extract. The 6% solids sample contained approximately 7g/L sugar, 15g/L acetic acid, and 11g/L sodium, while the sample at 10% solids contained 13g/L sugar, 25g/L acetic acid and 18g/L sodium.

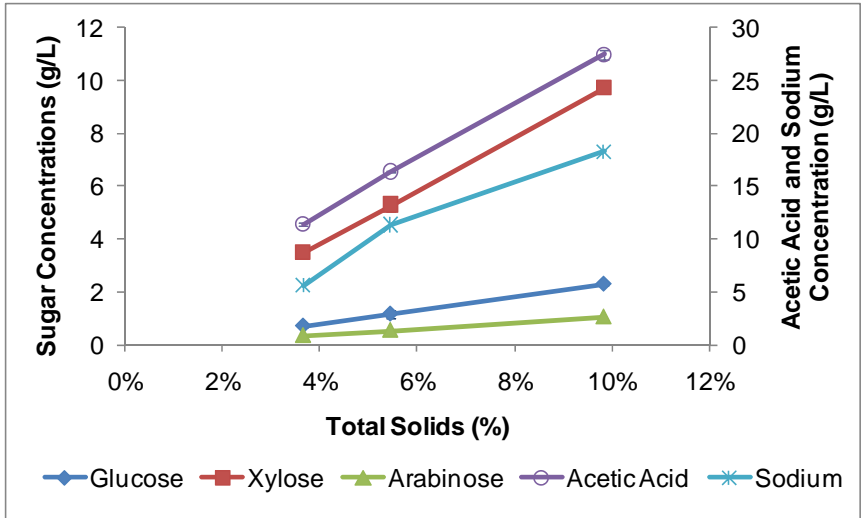


Figure 1: Composition of hemicellulose extracts concentrated in thin film evaporator

Fermentation of pure glucose and xylose mixtures was done with *E. coli* K011 in the presence of varying acetic acid levels to determine the expected level of inhibition. Figure 2 shows that this organism has a good tolerance for acetic acid, where the ethanol production at 12.5g/L of acetic acid even exceeds that of the control. As concentrations increase up to 25g/L of acetic acid the ethanol production shows a much greater lag phase, but not a significant effect on the ultimate concentration of ethanol obtained. The culture is able to adapt to the presence of acetic acid. Fermentation in the presence of acetic acid is done at higher pH than would be optimum for the control, which accounts for the lower ethanol production at 0g/L acetic acid.

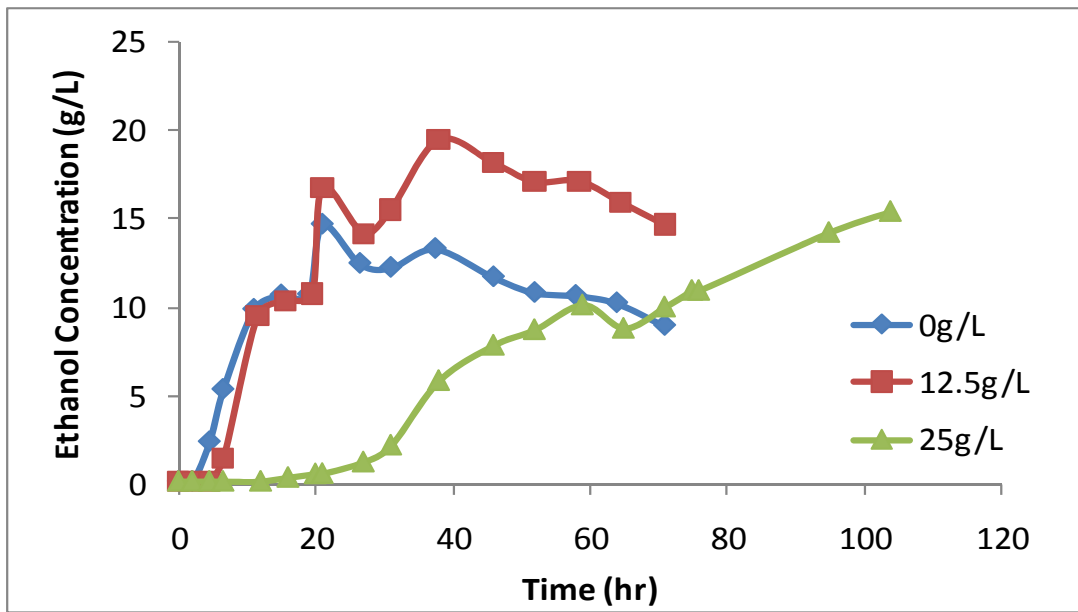


Figure 2: Ethanol Production in the presence of varying acetic acid levels

An additional baseline test was done by fermenting pure glucose and xylose mixtures in the presence of varying levels of sodium sulfate. Figure 3 shows the ethanol production as a function of sodium concentration. In this case the *E. coli* show a more classical inhibition, where increasing sodium levels have a decreasing ethanol production.

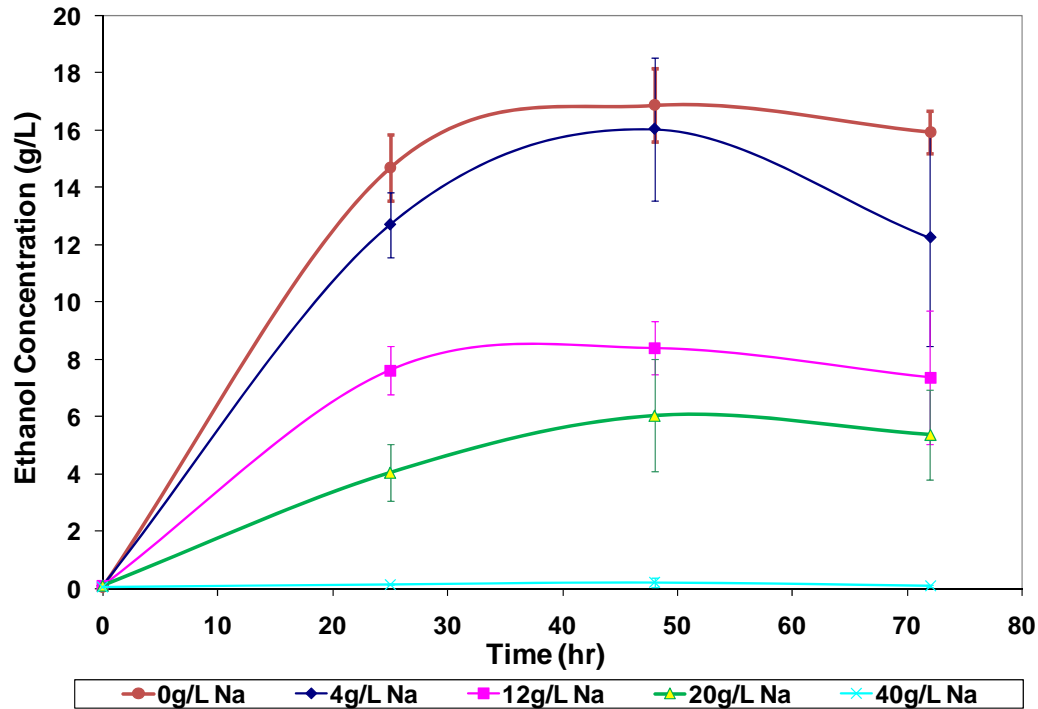


Figure 3: Ethanol production in the presence of varying sodium levels.

From figures 2 and 3 it can be seen that the 3%, 6% and 10% solids hemicellulose extracts contain acetic acid and sodium at concentrations that are expected to cause some level of inhibited growth, but still produce some ethanol. Figure 4 shows the actual results of fermenting hemicellulose extract at these 3 consistencies. Hemicellulose extracts at 3% and 6% solids were both readily fermentable, producing 1.2g/L and 2.1g/L of ethanol, respectively. These concentrations of ethanol are too dilute for economic product recovery, but do represent approximately 85% of the theoretical yields based on sugar consumption. The hemicellulose extracts at 10% solids were not initially fermentable, despite predictions that neither acetic acid nor sodium alone were concentrated enough to prevent growth. The combined effect of both inhibitors is enough to prevent *E. coli* growth. Initial attempts to adapt the culture to this high level of inhibitors has shown some success, where one culture was able to produce an amount of ethanol approaching that of the 3% solids extract.

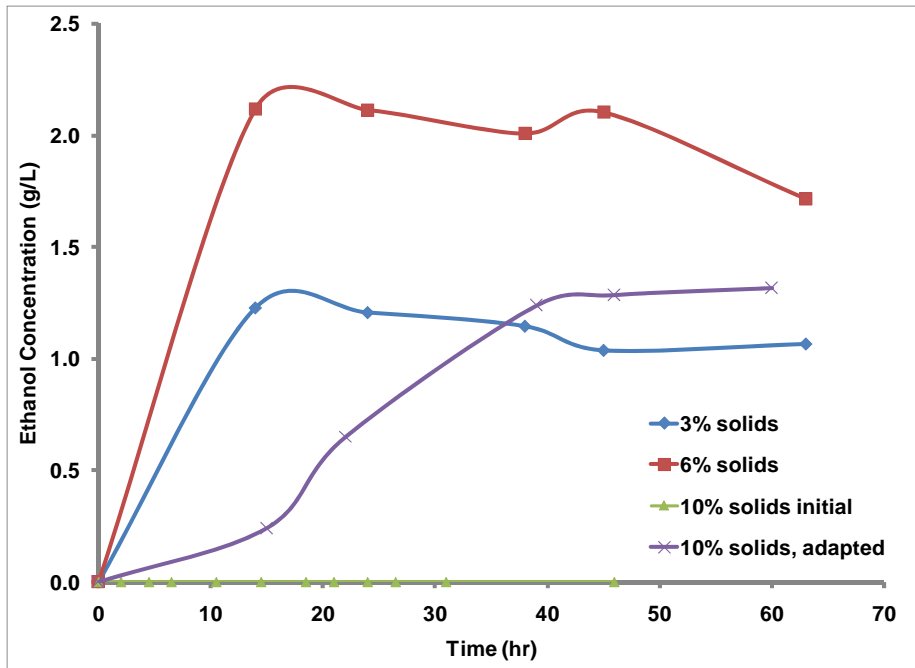


Figure 4: Fermentation of Hemicellulose Extracts at varying concentrations

Future efforts will focus on improving the tolerance of the fermentation organism to grow in highly concentrated extracts containing acetic acid and sodium.

#### Task C - Stimulation of Early-Stage R&D Development Program:

Maine Technology Institute staff oversaw Task C, developing a review process that could be incorporated into the well-respected, established Development Award program. Sub-tasks associated with this program included: modifying MTI Development Award Request for Proposals to include availability of financial match funding for forest bioproducts R&D projects (Note: MTI Development Awards provide up to \$500,000 for early-stage Research and Development leading to the commercialization of new products or services. Awards competitively reviewed for scientific merit, fit to program purpose and capacity, and require a minimum 1:1 match.); providing information and assistance to companies seeking financial support for pre-commercial R&D projects involving forest bioproducts; soliciting proposals specifically in the area of forest bioproducts R&D; educating interested parties on proposal and project requirements; receiving complete proposals requesting Development Award funding and DOE Forest Bioproducts match funding.

Once proposals were submitted by applicants, project sub-tasks included: evaluating submitted proposals; assigning a minimum of 3 expert peer reviewers per project; panel review of each project by Maine-based technology board with expertise in advanced technologies for forestry for consideration of potential benefit to Maine, including information determined from the feasibility study discussed above; cross-sectional panel

review of proposal for capacity to carry out proposed project, and feasibility of leading to commercialization; and MTI Board approving funding for recommended proposals. Once proposals were approved for MTI funding, sub-tasks included: assisting applicants recommended for additional DOE funding with the completion of DOE forms for DOE review; assisting recipients with Development Award contract execution; facilitating final project, statement of work, milestones, budget and certifications being approved by DOE; and executing DOE subcontractor agreement.

Finally, project sub-tasks transition to project monitoring including: disbursing MTI and DOE funds on a milestone basis contingent on successful milestone completion and documentation; monitoring funded projects quarterly, and incorporating company quarterly reports for each project into quarterly reports submitted to DOE.

MTI's approach was to use a portfolio approach, supporting four projects in early forest bioproduct R&D. Original projects were awarded funding as follows:

**Safe Handling:** Funds to conduct the necessary research and analysis to determine the technical, economic and financing feasibility of developing electricity, process steam and liquid transportation fuel(s) from pulp and paper mill waste (sludge). As this project moves through its stages, technical and economic criteria will be continually applied to assure that the project can proceed.

**Maine BioDiesel:** Project plan is to fractionate crude tall oil (CTO), yielding biodiesel and sterols. Initially, and in the period covered by this proposal, Maine Biodiesel will develop only the fuels fraction of the CTO, developing both bio-diesel ester and a super-pure "normal diesel" through treatment of the fractions. Crude tall oil is a by-product of the Kraft pulping process where coniferous feedstock is used, with Kraft mills producing from 3,000 to 10,000 gallons of CTO per day, depending on size and feedstock mix. This project will finalize the process engineering and economics of a commercial-demo plant producing 1.5 million gallons per year, in the process fully characterizing all aspects of the plant, rendering it "investment ready".

**Maine BioProducts:** Project is early-stage research into feasibility of levulinic acid plant. There were four technical objectives to be accomplished in initial technology assessment: 1) To gather definitive and specific data on the availability, the costs of pre-processing, and possible output yields of different inputs; 2) Targeted pilot testing for quantities and qualities of outputs, a full energy audit, and operating expenses; 3) Techno-economic analysis for optimizing input mix, siting, and sizing of a Maine plant; 4) Process engineering and manufacturing plant design to determine detailed estimates of approximate capital cost, production cost, and space and utility requirements.

**Tethys Research:** Tethys Research LLC is developing an enzyme-assisted pretreatment step for oxygen delignification to improve the yield and quality of cellulose from wood pulp while reducing the use of harsh chemicals. Unlike previous attempts at enzyme-assisted pulping, project targets the bonds linking hemicellulose to lignin. Included in the



project is the enzyme discovery phase to search for an enzyme that specifically targets lignin-hemicellulose bonds.

As projects progressed, it became clear that Safe Handling and Maine BioDiesel had reached deal-breaking obstacles and terminated their projects before all milestones were completed. Maine BioProducts and Tethys Research, however, completed all project milestones with great promise for continued efforts. MTI elected to award the remaining DOE funding available and additional MTI Development Award funding to these two continuing efforts. Having completed all DOE-funded milestones, these two projects are continuing with MTI funds and other public and private investments leveraged as a result of the initial investment by MTI and DOE.

### **Products Developed Under the Award**

Publications, papers or public releases of results:

Fractionation Development Center, "Biorefinery Feasibility Study, Siting and Infrastructure Addendum" October 2006.

MicroChem Technologies, "River Valley Biomass Refinery Market Study" January 2006

Acadia Environmental Technology, "Hydrogen Market Study" November 2006

Heller, J.J. P., S.M. Shaler, and A. van Heiningen. 2008. Influence of hemicellulose extraction on physical and mechanical behavior of OSB. Submitted to Forest Products Journal.

Mao, H., Genco, J. M., van Heiningen, A, and Pendse, H., "Technical Economic Evaluation of a Hardwood Biorefinery Using the "Near-Neutral" Hemicellulose Pre-extraction Process", In Press Journal of Biobased Materials and Bioenergy, Amar Mohanti, Editor, Vol. 2, 1-9 (2008).

Heller, J.J.P., R. Mills, S.M. Shaler, D. J. Gardner, and A. van Heiningen. 2008. Surface characterization of red maple strands after hot water extraction. Submitted Feb. 2008. Wood and Fiber Science.

Networks or collaborations fostered:

One of the important, intangible outcomes of this project was the development of a Forest Bioproducts Working Group for the state of Maine, made up of organizations funded through this project grant and others working in forest bioproducts area. This group met quarterly throughout the life of the grant project, and continues to meet currently on an informal basis. This opportunity to share lessons learned and network has been important to the continued development of this economic cluster.

### **Conclusion**

The Forest Bioproducts Research and Development project has been instrumental in building important stepping stones for the continued development of a vibrant forest bioproducts sector in Maine and has positioned Maine in the forefront of the development of an integrated forest products refinery. The excitement generated by the feasibility study has led to a sustained interest in the continued movement towards an IFPR. More importantly, the initial research done under this project led the University of Maine and its commercial partners to receive DOE support for a small-scale biorefinery, described below.

This innovative partnership involving University of Maine, Red Shield Environmental and American Process Incorporated was awarded a grant of up to \$30 million from the US Department of Energy to design, build and operate a small scale commercial biorefinery. This biorefinery will produce ethanol, acetic acid and other by-products along with market pulp in the RSE Pulp & Chemical's existing mill located in Old Town, Maine. Construction is expected to begin in 2009 and a fully integrated biorefinery will be operation in 2011. This award is the largest grant ever involving University of Maine research and certainly one of the largest for any academic or research organization in the state. The Old Town biorefinery project continues the work of the Forest Bioproducts Research Initiative (FBRI) designed to address the pressing issues of our time: replacements for fossil fuels, renewable energy, green chemicals - and creative uses of sustainable resources: in this case, trees, The current DOE award moves forest based cellulosic ethanol and bioproducts research from UMaine's labs to commercial mill operations and fulfills the original FBRI goal of "building research infrastructure that creates a forest biorefinery." This project will continue the work of FBRI collaborating Professors van Heiningen, Genco and Pendse in UMaine's Chemical and Biological Engineering Department. "This is the biorefinery that we have been talking about for the last four years," said FBRI's Administrative Director, Hemant Pendse. In December of 2007, Red Shield Environmental began preparing its mill to use the "van Heiningen process." The mill converted its existing one-vessel pulping system into a two-vessel system able to accommodate both production of pulp and the extraction of hemicellulose from wood chips. The extracted hemicellulose fibers are necessary to provide a new feedstock for ethanol production. These vessels now function like two pressure cookers piped together to allow various ingredients to flow in several different directions. Wood chips are fed into the first vessel used for extraction and sluiced into the second (pulp producing) vessel. The DOE grant will allow the mill to supply hemicellulose-rich extract streams for the ethanol production process while also continuing to produce the pulp that is currently manufactured on site.<sup>3</sup>

The University of Maine President Robert Kennedy summed up the importance of the foundation laid by DOE's initial investment in Maine's Forest Bioproducts R&D, "The

---

<sup>3</sup> Taken from <http://www.forestbioproducts.umaine.edu/news/30-Million-DOE-Grant-Awarded-to-Adapt-UMaine-Research-to-Commercial-Biorefinery>

development of new, renewable energy sources is critical to our future, and this grant demonstrates the great potential for creating fuel from forest bioproducts."<sup>4</sup>

Addenda:

Task A. documents:

1. Biorefinery Feasibility Study: Siting and Infrastructure Addendum
2. River Valley Biomass Refinery Market Study
3. Hydrogen Market Study

Task C. documents:

1. Request for Proposals used to solicit proposals for Forest Bioproducts Matching Fund program

---

<sup>4</sup> Taken from <http://www.forestbioproducts.umaine.edu/news/30-Million-DOE-Grant-Awarded-to-Adapt-UMaine-Research-to-Commercial-Biorefinery>



**Fractionation Development Center**  
**60 Lowell St.**  
**Rumford, ME 04276**

Phone: (207) 364-4179  
Fax: (207) 369-0356

**Biorefinery Feasibility Study**  
**Siting and Infrastructure Addendum**

## Table of Contents

### Maine Information and Facts

- Map of Maine 3
- Summary of site analysis 4-5
- Biomass Availability 5
- Maine Certified Landowners and Mills 6

### Transportation

- Posted Roads 7
- Weight Limitations 8
- Axle Weight Limits 8-9
- Transporting Hazardous Waste (by road or rail) 9-12
- Hazardous Chemical Reporting 12
- Rail Ratings (impact on road and rail) 12
- Deep Water Sea Terminals 12-13
- Railroads Operating in Maine 13-14
- Intermodal Facilities 14-15

### Worker Availability

- Availability/Pay Scale of Millwrights in Maine and in New England 15-16
- Availability/ Pay Scale of Chemical Engineers in Maine and New England 16-18

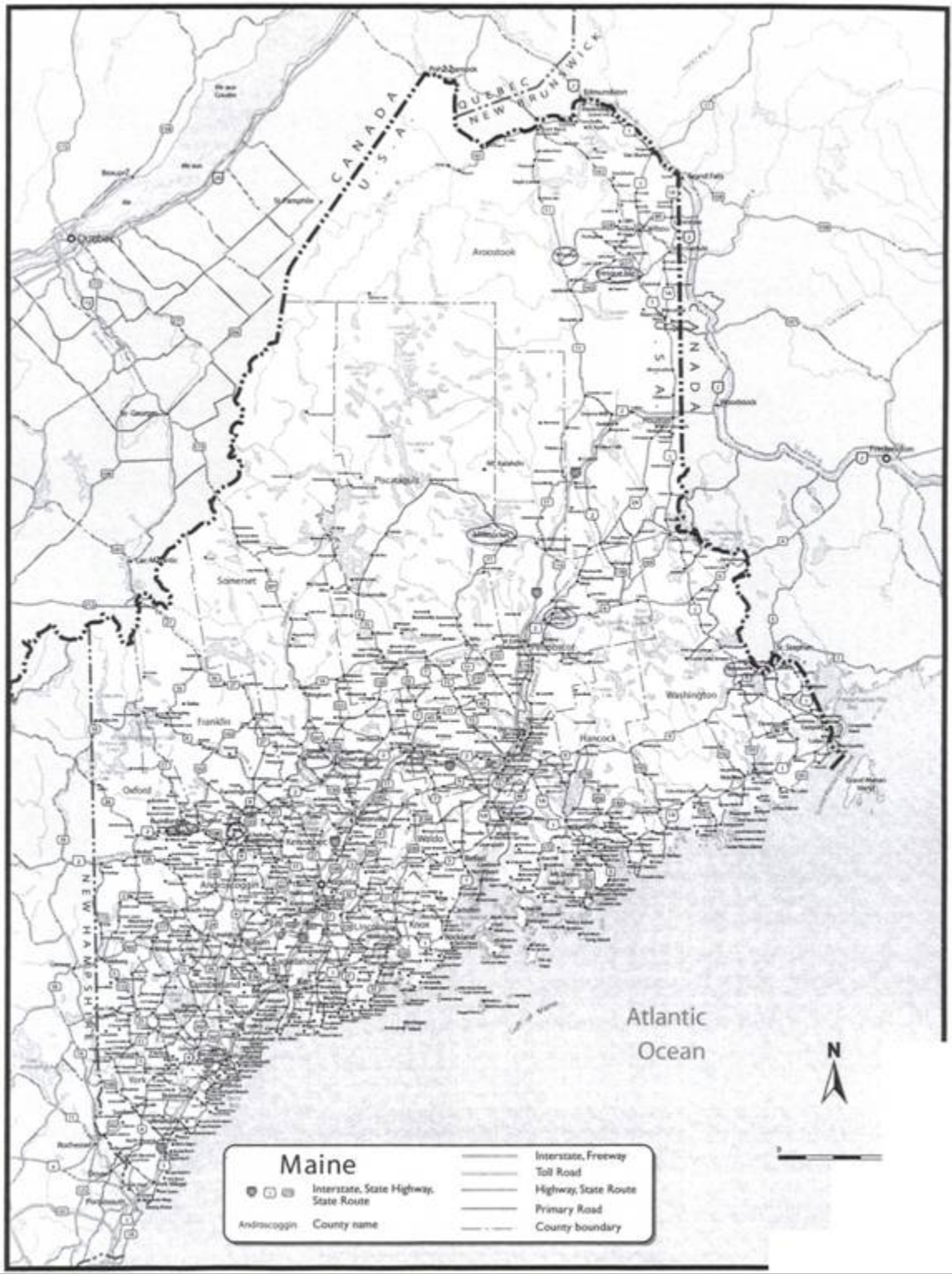
### Site Suitability Issues

- Availability of NMTC (CEI) 19-21
- Availability of Pine Tree Zones 21-22

### Site Profiles & Graphics

- Baileyville/Woodland 22-24
- Bucksport 25-31
- Jay 32-36
- Lincoln 37-39
- Madison 40-46
- Millinocket 47-54
- Portage 55-56
- Presque Isle 57
- River Valley 58-66
- Skowhegan 66-72
- Waldoboro 73-77
- Westbrook 78-82

# Maine Introduction



## Summary of Site Analysis

The Maine Biorefinery Feasibility Study, a comprehensive study undertaken by the River Valley Growth Council with support from the Maine Technology Institute and the UD Department of Energy, outlined a graduated pathway to viable biorefinery operations via a thermochemical platform that migrates to a fractionation platform. The process of identifying potential areas for a biorefinery was fairly straightforward: specific areas with sufficient biomass capacity, sufficient transportation infrastructure (both unposted road and rail), and proximity to pipelines and/or deep-water ports, were mapped. For each area, specific sites were sought that had sufficient access to utilities, were proximate to users of process products or by-products such as heat and fuel, or were proximate to water supplies and water treatment facilities. Finally, sites were evaluated relative to their ability to be included in Maine's Pine Tree Zone as well eligibility of sites for new market tax credits.

In the end, the sites that were early qualifiers were all proximate to major wood-processing hubs or were proximate to major industrial facilities (that had either located near all of the above desirable infrastructure or had attracted the build-up of said infrastructure over the years). The sites are included in the report because it is deemed likely that the initial biorefinery installations will require industrial infrastructure. However, this assumption may be prove to be false as technologies emerge that allow conversion processes to take place in the woods and even on mobile platforms that move with the harvest. Just the same, the criteria for characterizing the viability of potential biorefinery sites was chosen with the assumption that industrial infrastructure would be important, if not essential, to biorefinery operations. This choice was made based on the needs of the technologies that are closest to market. If and as other technologies come to market that require less of an infrastructure, then site selection will militate toward a framework where proximity to lowest-cost biomass is the primary criteria for selection.

For some biorefineries, transportation may be the key site criteria, especially if rail, deep-water ports, or a pipeline is necessary. With these and many other variables in place, it is not possible to develop a single ranking of potential sites in Maine. Instead, this portion of the Biorefinery Feasibility Study attempts to identify the leading sites for close-to-market technologies and provide information on the dynamics behind site selection by developers and technology holders. One section not covered in this report in any detail is the availability and type of biomass. One reason this area is not covered extensively is because it was already covered in the main body of the report. The second reason is because the feedstock required is dependent upon the technology deployed, and in many cases can be species dependent. Thus, sites selected for inclusion in this report are biomass hubs, with both harvesting and utilization of biomass going on, a wood-handling infrastructure in place and, in many cases, through-transport of biomass as well.

The sites selected as best meeting the general site needs of a biorefinery are:

- Baileyville/Woodland
- Bucksport
- Jay
- Lincoln
- Madison
- Millinocket
- Portage
- Presque Isle
- River Valley
- Skowhegan
- Waldoboro
- Westbrook

### **Biomass Availability**

Availability of both hardwood and softwood by in Maine by county has already been covered elsewhere in the Biorefinery Feasibility Study, and so it will not be replicated here. New information provided here is the distribution and ownership of certified forest holdings (chart, below) and mills that use certified forest material. Additional new material provided below is a listing of total biomass available in Maine broken down by the portion of the tree from which it is sourced.



Table 1: Current Land Area by Major Land Class, Maine, 2002  
 (Based on combined Panel #1 (1999 data), Panel #2 (2000 data), Panel #3 (2001), and Panel #4 (2002 data))  
 (in acres)

Land Class	4 Yr. Combined Estimate <sup>3</sup>	Net Change in Acreage in the 4 Yr. Combined Estimate	1995 Estimate <sup>2</sup>
Timberland - Rural	17,274,737	322,607	16,952,130
Timberland - Other Forestland	2,569	2,569	-
Timberland - Urban Forestland	61,649	22,559	39,090
<b>Total Timberland</b>	<b>17,338,955</b>	<b>347,735</b>	<b>16,991,220</b>
Forested Land - Productive Reserved <sup>1</sup>	275,731	(58,459)	334,190
Forested Land - Unproductive Reserved	36,822	30,592	6,230
Forested Land - Other	181,601	(186,059)	367,660
<b>Total - Other Forest Lands</b>	<b>494,154</b>	<b>(213,926)</b>	<b>708,080</b>
<b>Grand Total Forest Land</b>	<b>17,833,109</b>	<b>133,809</b>	<b>17,699,300</b>
Nonforest Land - Cropland	465,421	(86,979)	532,400
Nonforest Land - Pasture	95,185	(73,485)	168,670
Nonforest Land - Other	1,282,519	(44,861)	1,327,380
Nonforest Land - Noncensus Water	75,160	49,600	25,560
<b>Grand Total Nonforest Land</b>	<b>1,918,285</b>	<b>(135,725)</b>	<b>2,054,010</b>
<b>Grand Total, All Land Classes</b>	<b>19,751,394</b>	<b>(1,916)</b>	<b>19,753,310</b>

<sup>1</sup> The 1995 area estimate for Forested Land - Productive Reserved is based on a combination of ground plot estimates and reported acreages by public agencies

<sup>2</sup> The 1995 Estimate is based on the 1990 Census Land Area Acreages for each county

<sup>3</sup> The 2002 Estimate is based on the 2000 Census Land Area Acreages for each county

### Maine Certified Landowners and Mills

	Acres in Certification or Verification System			
	FSC	SFI	Both FSC & SFI	Tree Farm
<b>Certified Landowners</b>				
Baskahegan Land Co	101,000			
Baxter State Park Scientific Forest Management Area	29,587			
Bayroot Timber, LLC		500,000		
Black Bear Forest, Inc.		981,668		
Domtar, Inc.			41,000	
Hancock Land Company	32,945			
Heartwood Forestland		238,000		
Irving Woodlands LLC		1,550,000		
Maine Department of Conservation Bureau of Parks and Lands			485,000	
Merriweather LLC		285,000		
New England Forestry Foundation	1,986			
Plum Creek Timber		953,492		
Robbins Lumber Company		30,000		
Seven Islands/Pingree Associates			975,000	
The Nature Conservancy	170,000			
Typhoon, LLC		430,144		
<b>Group Certifications</b>				
SWOAM - ATFS Group - 3rd Party				30,000
<b>Certified Land Managers for Multiple Landowners</b>				
Mid Maine Forestry	6,381			
Two Trees Forestry	17,509			
Hancock Land Company	1,000			
New England Forestry Consultants, Inc				
<b>Total:</b>	<b>360,408</b>	<b>5,086,636</b>	<b>1,501,000</b>	<b>330,000</b>
<b>Grand Total:</b>	<b>7,278,044</b>			
<b>Certified Forest Products Companies</b>				
A.E. Sampson & Son, Ltd	<input checked="" type="checkbox"/>			
Bethel Furniture Stock, Inc.	<input checked="" type="checkbox"/>			
Columbia Forest Products	<input checked="" type="checkbox"/>			
Domtar	<input checked="" type="checkbox"/>			
ED Bessey & Son				
Georgia Pacific Corporation		<input checked="" type="checkbox"/>		
H. A. Stiles Company (HASCO)	<input checked="" type="checkbox"/>			
Hancock Lumber		<input checked="" type="checkbox"/>		
Louisiana-Pacific Corporation		<input checked="" type="checkbox"/>		
J. M. Huber Corporation - Wood Products		<input checked="" type="checkbox"/>		
Maine Ornamental Woodworkers, Inc.	<input checked="" type="checkbox"/>			
Maine WoodNet Certified Group	<input checked="" type="checkbox"/>			
Maine Woods Company LLC	<input checked="" type="checkbox"/>			
MeadWestvaco		<input checked="" type="checkbox"/>		
Pride Manufacturing Company, LLC	<input checked="" type="checkbox"/>			
RR Donnelley & Sons Company	<input checked="" type="checkbox"/>			
SAPPI		<input checked="" type="checkbox"/>		

## Transportation

### Posted Roads:

Aside from the differentiation between limited access highways and all the other roads in Maine, there is an important distinction between “posted” and “unposted” roads. A posted road is a road that is not allowed to bear heavy loads during the spring thaw period because such loads will cause the road to buckle and decrepitate very rapidly. An unposted road is generally one was engineered to take heavy loads and has a build-up of gravel or other material over the soil and under the pavement. The nature of posting roads (see below) means that any facility that relies on feedstock traveling over posted roads will not have a secure flow of feedstock. Therefore, sites that rely primarily or to any great degree on surrounding posted roads will be less desirable than on sites that are not affected by road postings. Generally, numbered roads in Maine are not posted. Statute language for road posting follows:

“Under authority of 29-A MRSA, Section 2395, all public roads may be temporarily posted to prevent abuse by heavy vehicles. The statute states that all municipal officers, the MDOT, and county commissioners, “may adopt such rules to ensure proper use and prevent abuse of the public ways...whenever those ways require special protection.” (A municipal officer is the highest level of government (i.e. selectman, town councilor) in a town. A town manager or road commissioner is not an officer.)”

- The MDOT has a regular posting period from November 15 to June 1 each year
- Many of Maine’s rural roads are not capable of handling heavy loads even during the summer or fall as well. It is advisable to check with local municipalities for road postings each season
- Signs for road postings must be “conspicuously posted” at each end of the section of road to be posted
- The effective date of posting should precede any significant thawing. Road postings in early March are typical because of road surface softening and then refreezing at night. Vehicles are not allowed on any road which is less than solidly frozen. Roads are considered solidly frozen when the air temperature is 32 degrees or below and no water is showing in the cracks of the road if paved, and there is no less than ½” of thaw on gravel.
- Postings are commonly removed by May 15<sup>th</sup> but can last until after the frost has come out and all excess water has drained off. Northern Maine postings usually last until early May, where Southern Maine’s may be removed in mid-April.
- On roads posted, gross weight is defined as the combined weight of the vehicle and its load. These regulations shall not apply to any closed highway that is solidly frozen. Lists of exempt vehicles may be found on the following website.
- [www.maine.gov/mdot/mlrc/traffic-issues/restricregs2000.php](http://www.maine.gov/mdot/mlrc/traffic-issues/restricregs2000.php)

Weight limitations:

Under general law, the total weight of a vehicle or a combination of vehicles. Plus their load, is limited by the number of axles to:

- 2 axles: 34,000 lbs
- 3 axles: 54,000 lbs
- 4 axles: 69,000 lbs
- 5 axles: 80,000 lbs
- 6 axles: 100,000 lbs\* (Tractor Trailer Truck)

\*: Applies only to a combination of a 3-axle tractor triaxle semitrailer vehicle operating off the interstate; the 80,000 lb limit applies to all other combination vehicles over 4 axles except for vehicles carrying special commodities

Axle Weight Limits:

- Axles whose centers are less than 4 feet apart shall be considered a single axle unit
- A single axle whose center is closer than 10 feet, or if it is a steering axle 9 feet, to a triaxle unit, shall be considered part of that triaxle and not add to the allowable load capacity of the triaxle unit
- All loads are limited to 600 lbs per inch of tire width, manufacturer's rating, excepting certain farm vehicles

A tractor trailer truck has a weight limit of 100,000 lbs (load and truck), For logs and chips the weight in a tractor trailer would be roughly 60-65,000 lbs per truck. To transport 750 tons of any material per day and stay within the weight limits set forth by the State, about 15 trucks would be needed.

In order to determine the impact of transporting 100,000 gallons of material or chemical per day by road, you must first know the substance and its weight. Using the gross weight limits set forth by the state for road travel, one can then figure how many truckloads would be necessary to transport 100,000 gallons through the River Valley Area.

Tolerances and Permits (Excluding the interstate)

- Provided that gross, axle and tire limits are not exceeded, vehicles may operate at a gross weight exceeding the current registration by the greater of 2 ½ percent or 500 lbs.
- While engaged in the exclusive transport of the commodities listed below, vehicles will be allowed special limits: 10% over the maximum gross weights, 100,000 lbs GVW for combination vehicles consisting of three-axle truck tractor (not truck) with triaxle semitrailer, Axle weight limits: wheelbase reductions for 4 or more axle combinations

- Materials or unset concrete intended for highway construction and carried in dump or transit-mix trucks
- Manufacturer's concrete products
- Raw ore from mine or quarry to place of processing
- Unprocessed milk
- Refrigerated products when they constitute the majority or products carried in a sealed vehicle
- Building material that absorb moisture during delivery originating and terminating within the State
- Incinerator ash
- Unconsolidated rock materials, including limestone, bark, bolts, sawed lumber, farm produce, road salts, solid waste, sawdust, wood chips, dimension lumber, recyclable materials, pulpwood/firewood/logs
- [www.state.me.us/sos/bmv/commercial/swlimit.htm](http://www.state.me.us/sos/bmv/commercial/swlimit.htm)

Transporting Hazardous Waste/Chemicals: (by road or rail)

Biorefineries in Maine will produce materials that will, in almost all cases, be considered hazardous. In most cases, this will be because the fuels and chemicals produced are combustable, as are the fossil fuels that the forest-based fuels will be replacing. To this degree, roadway risk and hazard is not increased by hauling bio-fuels, and it may not be decreased because the fuel simply replaces a fossil fuel. In any event, a portion of biorefinery site selection is related to relative preference and advantage for transporting product over road or over rail. This is a criteria that cannot be effectively assigned without knowing the exact product to be manufactured, the distance to the customer for that product, etc., etc. Each biorefinery will compare and contrast advantages of road and rail as appropriate to their situation. General Maine State regulations affecting the transport of hazardous materials over the road are listed below.

Some biorefineries may process was in addition to biomass. Waste is defined as, “any useless, unwanted or discarded substance or material, whether or not such a substance or material has any other or future use and includes any substance or material that is spilled, leaked, pumped, poured, emitted, disposed, emptied, or dumped onto the land or into the water or ambient air. This definition includes, without being limited to, materials which are used in a manner constituting disposal, burned for energy recovery, reclaimed or accumulated speculatively.”

Hazardous Waste definitions can be found through the Department of Environmental Protection, Identification of Hazardous Wastes, Chapter 850, see attached research:

- License Certificates may be obtained to transport hazardous materials through the Department of Environmental Protection of the State of Maine. License Certificates are necessary for a conveyance (watercraft, aircraft, vehicle, or other machine used for transportation on land, water,

or in the air.) For license requirements, the term includes only the cargo-carrying portion of the conveyance.

- A Transporter Identification Number must be obtained by applying using EPA Form 8700-12 to the: EPA Administrator, U.S. Environmental Protection Agency-Region 1, John F. Kennedy Federal Building, Boston, MA 02203
- Application for a Transporter license shall be made on a form obtained from the Department. Specification of the type of hazardous material, including the source and destination must be included in the application.
- A transporter which is a business that engages in transportation of hazardous waste may apply for a license that will cover all business locations, all conveyances owned, leased, or otherwise controlled, and all operators.
- Temporary emergency transporter licenses are available<sup>1</sup>

*Hazardous Shipping Requirements:*

a) General requirements. A person may not accept a hazardous material for transportation or transport a hazardous material by highway unless that person has received a shipping paper prepared in accordance with part 172 of this subchapter or the material is excepted from shipping paper requirements under this subchapter. A subsequent carrier may not transport a hazardous material unless it is accompanied by a shipping paper prepared in accordance with part 172 of this subchapter, except for § [172.204](#), which is not required.

▶ (b) Shipper certification. An initial carrier may not accept a hazardous material offered for transportation unless the shipping paper describing the material includes a shipper's certification which meets the requirements in § [172.204](#) of this subchapter. Except for a hazardous waste, the certification is not required for shipments to be transported entirely by private carriage and for bulk shipments to be transported in a cargo tank supplied by the carrier.

▶ (c) Requirements when interlining with carriers by rail. A motor carrier shall mark on the shipping paper required by this section, if it offers or delivers a freight container or transport vehicle to a rail carrier for further transportation;

▶ (1) A description of the freight container or transport vehicle; and

▶ (2) The kind of placard affixed to the freight container or transport vehicle.

---

<sup>1</sup> *Department of Environmental Protection of the State of Maine, Licensing of Transporters of Hazardous Waste*

- ▶ (d) This subpart does not apply to a material that is excepted from shipping paper requirements as specified in § [172.200](#) of this subchapter.
  
- ▶ (e) Shipping paper accessibility-accident or inspection. A driver of a motor vehicle containing hazardous material, and each carrier using such a vehicle, shall ensure that the shipping paper required by this section is readily available to, and recognizable by, authorities in the event of accident or inspection. Specifically, the driver and the carrier shall:
  - ▶ (1) Clearly distinguish the shipping paper, if it is carried with other shipping papers or other papers of any kind, by either distinctively tabbing it or by having it appear first; and
  
  - ▶ (i) When the driver is at the vehicle's controls, the shipping paper shall be: (A) Within his immediate reach while he is restrained by the lap belt; and (B) either readily visible to a person entering the driver's compartment or in a holder which is mounted to the inside of the door on the driver's side of the vehicle.
  
  - ▶ (ii) When the driver is not at the vehicle's controls, the shipping paper shall be: (A) In a holder which is mounted to the inside of the door on the driver's side of the vehicle; or (B) on the driver's seat in the vehicle.
  
- ▶ (f) Retention of shipping papers. Each person receiving a shipping paper required by this section must retain a copy or an electronic image thereof, that is accessible at or through its principal place of business and must make the shipping paper available, upon request, to an authorized official of a Federal, State, or local government agency at reasonable times and locations. For a hazardous waste, the shipping paper copy must be retained for three years after the material is accepted by the initial carrier. For all other hazardous materials, the shipping paper copy must be retained for one year after the material is accepted by the carrier. Each shipping paper copy must include the date of acceptance by the carrier. A motor carrier (as defined in [390.5](#) of subchapter B of chapter III of subtitle B) using a shipping paper without change for multiple shipments of one or more hazardous materials having the same shipping name and identification number may retain a single copy of the shipping paper, instead of a copy for each shipment made, if the carrier also retains a record of each shipment made that includes shipping name, identification number, quantity transported, and date of shipment.

- [www.myregs.com/dotrspa](http://www.myregs.com/dotrspa)- All federal rules and regulations for transporting hazardous material found here

Hazardous Chemical Reporting:

- “All facilities in the State of Maine must report those hazardous chemicals and/or extremely hazardous substances that were present at the facility during the preceding calendar year at or above established threshold planning quantities.”
- They must fill out the State of Maine Chemical Inventory Reporting Form to the State Emergency Response Commission (SERC) via the Maine Emergency Management Agency, the appropriate local emergency planning committee (LEPC) via the county Emergency Management Agency, and the Fire Department with jurisdiction over the facility. All fees are sent to the Maine Department of Defense.
- The threshold planning quantity for hazardous chemicals is 10,000 lbs. There are fees associated with the quantity of chemicals reported
- The Federal Highway Administration’s Office of Motor Carriers and the Maine State Police may be contacted for detailed information on the transportation of hazardous waste as well.

Rail Ratings/Impact on Road and Rail (Hazardous Materials 100,000 gallons a day):

- The Federal Railroad Administration holds authority over all railroads. Hazardous or flammable material transportation is regulated by Federal guidelines and as listed above.
- Railroads are rated by track and by car. The standard capacity of a rail car is 286,000 lbs for a newer car and for older cars around 220-240,000 lbs. New cars are being produced with the capacity of 315,000 lbs. Overall; rail car capacity will depend on the capacity and quality of the track beneath. Tracks are rated by class by the FRA.
- In order to determine what impact 100,000 gallons of substance would have on rail you must factor that an older tank car with a capacity of 263,000 lbs could hold 34,500 gallons. Today’s standard tank cars can hold 286,000 lbs and so it can be estimated that these tank cars could carry roughly 37,500 gallons. To transport 100,000 gallons per day it would take about 3 standard tank cars.

Deep Water Sea Terminals: (Eastport, Searsport, Portland, Penobscot Riverway: Bangor and Bucksport):

Eastport: Two terminals available, intermodal facilities available



- Eastport Breakwater Terminal: Berthing for a vessel up to 700 ft., approach depths to the breakwater are over 100ft, mean low water depth is 42 ft.
- Estes Head Cargo Terminal: Berth A for a vessel up to 900ft., Berth B for a vessel up to 550ft. Approach depths well over 100 ft., mean low water depth is 64 ft. Stevedoring and trucking services available for 5,000-20,000 lbs
- Searsport: Rail access through Maine & Atlantic Railway. Accepts dry cargo and liquid cargo.
- Dry Cargo: Berth 1 vessel up to 800 ft. with 40 MLW. Berth 2 vessels up to 800 ft. with 32 MLW
- Liquid Cargo: Berth 1 vessels up to 700 ft. with 37 MLW, Berth 2 vessels up to 500 ft. with 25 MLW
- Intermodal 6,500 ft. rail slid in with Canadian Pacific Railway. Double stack service to US mid-west, central Canada and Vancouver. Approach channel and Turning basin 35 ft. at MLW

Bangor: Specializes in sending home heating oil and petroleum. 15 ft. at MLW

Bucksport: Ocean Tankers and fuel barges, 29 ft. at MLW. Berthing cap is 700 ft. Rail service available from Maine Central Railroad/ Springfield Terminal

Portland: Rail system available. Featuring 3000ft. of deep water linear berthing. 730ft regular berthing with 35 ft. MLW. Intermodal truck/rail coordination, purchase of new or used barge containers, maintenance, storage, and all other barge services can be obtained through Columbia Coastal Transport Services. [www.columbia-coastal.com](http://www.columbia-coastal.com)  
[www.maineports.com](http://www.maineports.com)

Railroads Operating in Maine:

- Montreal, Maine & Atlantic Railway
- Maine Eastern Railroad
- New Hampshire North Coast Corporation
- St. Lawrence & Atlantic Railroad (Runs through Oxford County)
- Springfield Terminal Railway/ Guilford Transportation (Runs through Oxford County)
- Eastern Maine Railway Company
- The three core regional railroads are the Montreal, Maine & Atlantic, the St. Lawrence & Atlantic, and the Guilford Rail System (GRS)

- Transporting by rail is particularly cost-effective when moving high volume, low-value commodities over long distances
- [www.maine.gov/mdot/freight/maine-freight-railroads.php](http://www.maine.gov/mdot/freight/maine-freight-railroads.php)

Intermodal Facilities:

Genesee & Wyoming Canada, Inc., Auburn Intermodal Truck/Rail Transfer Facility (Maine Intermodal Transportation, Inc.): Runs through Lewiston, Auburn, Mechanic Falls, and South Paris. Part of the CN intermodal network and uses the St. Lawrence & Atlantic railway where it connects to the Guilford Rail System at Danville Junction. Provides seamless cross-border service and enhanced access to the international marketplace (Asia, Canada, Europe, and Mexico).

To provide infrastructure for its railroad lines to grow, the State of Maine partnered with local rail lines to build a truck-to-rail intermodal facility in Auburn, located about 40 miles north of and inland from Portland, Maine. Auburn is well situated as an intermodal hub because of its proximity to rail lines, an airport, the Maine Turnpike, and the State highway network; both the railroads and local authorities saw an opportunity for growth. Auburn is bisected by the St. Lawrence & Atlantic Railroad, which runs 260 miles between Portland and St. Rosalie, Québec. The St. Lawrence & Atlantic connects with Canadian National Railway at Richmond, Québec, which gives Maine access to deep-water ports at Halifax in the east and Vancouver in the west. Shippers on the West Coast with products from Asia have the option of using two rail lines that cross the United States, but the journey across Canada bypasses congestion in Chicago and can be less expensive for shippers. The Auburn terminal is less than 3 miles from the Maine Turnpike and 140 miles from Boston. Gate hours are 24/day, 7 days a week. [www.  
http://fhwa.dot.gov/environment/cmaqpgs/amaq/03cmaq4.htm](http://fhwa.dot.gov/environment/cmaqpgs/amaq/03cmaq4.htm)

- Contracts for shipping is granted by the St. Lawrence & Atlantic Railway-short line for the Canadian National Railway
- Rates based on type of commodity and destination
- Agreement must be signed with Maine Intermodal to ship out of Auburn facility
- Hazardous and Flammable transport must meet Maine DOT standards, same as transporting by road. Placards must be placed on all four sides of trailers or containers at least four feet high
- Weight limits are the same as road gross weight limits
- Containers available are 48' and 53'
- Auburn terminal handles paperwork and notifies shippers and receiving parties when shipment has arrived/departed, inspections, and loading/unloading of cargo

Presque Isle Intermodal Facility: The Presque Isle Intermodal Terminal is owned by the City of Presque Isle and leased to an independent intermodal operator. It runs on the Bangor & Aroostook Railroad to Montreal. The operator offers truck/rail transportation

utilizing a state-of-the-art Mi-Jack Reach Stacker to handle containers and trailers for rail flatcar shipments throughout the United States and Canada. The intermodal operator also provides warehousing services with loading dock access for truck or railcar shipments, which helps round out the services provided at the intermodal terminal.

Waterville Intermodal Facility: Guilford Motor Express operates the Waterville facility, which offers daily rail intermodal service to and from destinations such as Atlanta, Cleveland, Columbus, Toledo, Indianapolis, Chicago, St. Louis, Kansas City, and other markets. Shipping orders, advanced pre-notification of arrivals, and payment can all be arranged with one call to Guilford. Your transportation needs can be handled electronically if you choose. Gate hours are 24 hours a day Monday-Friday; 0800-1700 Saturday-Sunday. The Waterville facility offers 2 packers and TOFC and COFC. The facility also has a back-up packer.

<http://www.maine.co.org/advantages/transportation.htm>

Coming Soon:

Fairfield Truck to Rail Transfer Facility, Fairfield, ME: Construction of an intermodal facility, including storage areas, staging and other facilities, similar to the Auburn project above. Only funds for preliminary engineering have been obligated so far. Maine DOT has requested \$1.9 million in CMAQ funding for the \$3.5 million project.

The State of Maine has funded additional intermodal truck to rail facilities, as described in the discussion of ISTEA-funded projects, in Auburn, Winterport, Saco and Portland. An additional \$491,000 has been obligated to improve freight access to rail thereby reducing long-haul truck mileage.

<http://www.fhwa.dot.gov/environment/cmaqpgs/retroatt.htm>

## **Worker Availability**

*Availability/Pay Scale of Millwrights in Maine and in New England:*

Maine:

- 2002 Estimated Employment: 749
- 2012 Projected Employment: 597, -152 with an annual loss of -2.2 and a total percent change of -20.3 (*Maine Department of Labor*)
- Career Builder.com visited on March 24, 2006: Listings for Millwrights in Maine=1, Listing for Millwrights in New Hampshire, Massachusetts, New York, Vermont, and Connecticut= 4
- Average pay, Oxford County, *Source: Maine Department of Labor Wage Survey for 2004 in Oxford County*: \$15.11/hr or \$31,435 annually for entry level, \$16.75/hr or 34,845 annually for mean (average), \$16.02/hr or 33,322 annually Median, and \$17.57 for Experienced.

- Average pay, Statewide, *Source: Bureau of Labor Statistics, Occupational Employment Statistics Survey; Maine Department of Labor, Labor Market Information Services*: \$13.96/hr or \$29,000 annual for 10% range, \$16.16/hr or \$33,600 annual for 25% range, \$19.68/hr or \$40,900 annual for Median range, \$23.74/hr or \$49,400 annual for 75% range, \$26.73/hr or \$55,600 annual for 90% range.
- Distribution of Educational Attainment: Percent of employees aged 25 to 44 in the occupation whose highest level of educational attainment is- High School or less: 60.2%, Some college: 39.3%, Bachelor degree or more: 0.5% (*Bureau of Labor Statistics, Office of Occupational Statistics and Employment Projections(Education/Training Level, Educational Attainment); National Center for Education Statistics(Typical Instructional Programs)*)

New England:

- Median Wage for Millwrights in New England:
- CT: \$19.02/hr or \$39,600 annual
- MA: \$20.60/hr or \$42,800 annual
- NH: \$20.39/hr or \$42,400 annual
- NY: \$21.82/hr or \$45,400 annual
- RI: No data available
- VT: \$17.16/hr or \$35,700 annual (*Bureau of Labor Statistics, Occupational Employment Statistics Survey; Massachusetts Division of Career Services and the Division of Unemployment Assistance, Economic Data*)

Millwrights normally train for 4 years through an apprenticeship program that combines on-the-job training and classroom instruction- or through informal community college coupled with informal on-the-job training. Usually no formal education is required. Millwrights held about 82,000 jobs in the United States in 1998. Employment for millwrights is concentrated in heavily industrialized areas. Historical employment of millwrights has been fairly stable; the growing use of machinery should ensure that this employment's decline will be small. ([www.jobbankusa.com](http://www.jobbankusa.com))

According to Gerard Dennison at the Lewiston Career Center, based on a 2004 study, there are 710 millwrights in the state of Maine. (information obtained 3/29/06)

*Availability/ Pay Scale of Chemical Engineers in Maine and New England:*

- 2002 Estimated Employment: 217
- 2012 Projected Employment: 207, -10 with an annual average loss of -0.5, -4.6 percent change. (*Maine Department of Labor*)
- Careerbuilder.com visited on March 24, 2006. Listings for Chemical Engineers in Maine: 1. Listing in NH, MA, NY, VT, CT, RI: 218

- Monster.com visited on March 24, 2006. Listings for Chemical Engineers in Maine-1, MA-11, CT-1, NY-1, NH-1, RI-0
- Average pay, Statewide, *Source: Bureau of Labor Statistics, Occupational Employment Statistics Survey; Maine Department of Labor, Labor Market Information Services*: \$24.95/hr or \$51,900 annual for 10% range, \$29.96/hr or \$62,300 annual for 25% range, \$35.01/hr or \$72,800 annual for Median range, \$42.37/hr or \$88,100 annual for 75% range, \$50.27/hr or \$104,600 annual for 90% range.
- Industry Employment Trends: 2002 Estimated Employment in United States 112,400. Projected 2012- 79,400. -29% change. (*Bureau of Labor Statistics and Employment Projections*)
- The University of Maine is the only Chemical Engineering Program in the State. Currently they have 90 students in the undergraduate program. Typically they graduate 20-30 students per year; with their current enrollment they will be graduating 20 students per year for the next few years. 80% of their students are from Maine. Most students find work or enroll in a graduate program. Those that found employment usually are employed by the pulp and paper industry or the semi-conductor industry (National Semiconductor and Fairchild in Portland, ME) Both industries have been slow in the past few years but the paper industry is picking up and more jobs are becoming available. Most graduates stay in Maine or New England to work. (*John Hwalek, Department of Chemical Engineering, University of Maine*)
- Occupation Description: “Design chemical plant equipment and devise processes for manufacturing chemicals and products such as gasoline, synthetic rubber, plastics, detergents, cement, paper, and pulp, by applying principles and technology of chemistry, physics, and engineering.” (*America’s Career InfoNet, [www.acinet.org](http://www.acinet.org), 3/28/2006*)
- Distribution of Educational Attainment: Percent of employees aged 25-44 in the occupation whose highest level of educational attainment is: High School or less: 1.7%, Some College: 5.4%, Bachelor Degree or more: 92.9%. (*Bureau of Labor Statistics, Office of Occupational Statistics and Employment Projections(Education/Training Level, Educational Attainment); National Center for Education Statistics(Typical Instructional Programs)*)
- According to Gerard Dennison of the Lewiston Career Center, based on a 2004 survey, there are 160 Chemical Engineers in the State of Maine.
- One listing on Monster.com for a Chemical Engineer in Maine shows the pay scale to be \$65,000-\$80,000/year plus commissions, company car, employee benefits, laptop, cell phone, and expense account. Bachelor’s Degree required.

#### New England:

- Median wage for Chemical Engineers in New England:
- CT: \$37.11/hr or \$77,200 annual

- MA: \$37.39/hr or \$77,800 annual
- NH: \$33.82/hr or \$70,300 annual
- NY: \$35.48/hr or \$73,800 annual
- RI: \$31.77/hr or \$66,100 annual
- VT: \$30.43/hr or \$63,300 annual
- *(Bureau of Labor Statistics, Occupational Employment Statistics Survey; Massachusetts Division of Career Services and the Division of Unemployment Assistance, Economic Data)*

#### Graduates in Chemical Engineering- New England and Neighboring States 2003/2004

- Massachusetts Institute of Technology: 43
- Northeastern University (MA): 35
- Rutgers University (NY): 37
- Rensselaer Polytechnic Institute (NY): 45
- Cornell University: 46
- Drexel University: 44
- Lehigh University: 48
- Carnegie Mellon: 64
- [www.asee.com](http://www.asee.com)

Chemical Engineering in Maine is a small but steady occupation. The majority of chemical Engineers within the State are employed by the pulp and paper industry or semi-conductor industry. The University of Maine in Orono is the only school in the State currently offering a degree program in Chemical Engineering. They graduate 20-30 students per year and out of these students, nearly all work in Maine or New England post-college. According to a 2004 survey done by the Maine Department of Labor, there are 160 chemical Engineers employed in Maine. The job market over the past few years has been slow but with the increased use of machinery in manufacturing industries, employment for chemical engineers has been increasing. With the creation of a Biorefinery, employment opportunities will also be produced for both chemical engineers and millwrights. New positions within the field of chemical engineering and maintenance will often encourage those graduates to stay within the State, and graduates from nearby to relocate. As long as comparable wages and benefits are offered, the availability of the positions necessary to maintain a biorefinery is present in Maine and the surrounding states.

## **Site Suitability Issues:**

### Availability of NMTC (CEI):

CEI: “CCML is a for profit CEI subsidiary that furthers CEI's mission by working to help attract capital to low-income areas using the federal New Markets Tax Credit (NMTC) program. CEI and CCML take a triple bottom-line approach as an NMTC program sponsor when underwriting prospective transactions, looking for strongly positive economic and community development impacts, social equity, and environmental protection. The U.S. Treasury Department's CDFI Fund's New Markets Tax Credit Program mission is to expand the availability of credit, investment capital, and financial services in distressed urban and rural communities. Specifically, the CDFI Fund's New Markets Tax Credit Program was authorized by Congress to help attract private sector capital investment into urban and rural low-income areas to finance community development projects, stimulate economic opportunities and create jobs in areas with the greatest need. CEI participated in the initial conceptualization and development of the NMTC initiative at the national level. CEI continues to take a progressive, leadership role as a member of the NMTC Coalition and embraces the Coalition's goal of directing NMTC resources to community development projects that create enduring opportunities for people and places traditionally outside of the economic mainstream. CCML is using the NMTC program to create greater access to capital for real estate development and operating businesses located in eligible low-income communities, primarily in Maine, the other New England States, and New York. CEI has also now extended its NMTC services to encompass all of rural America.” ([www.ceimaine.com](http://www.ceimaine.com), 3/29/2006)

NMTC: The New Markets Tax Credit (NMTC) program, established by Congress in December 2000, gives individual and corporate taxpayers the opportunity to receive a credit against income taxes by investing in qualified investment entities. This program also allows CEI to participate in large-scale projects that meet our 3E criteria.

Investors can earn attractive rates of return while meeting a community need, qualified businesses gain access to development funds at reasonable rates, and community development entities fulfill their mission by helping stimulate economic growth and job creation in specifically targeted lower-income communities. While CEI focuses principally in the Maine, New Hampshire, Vermont, western Massachusetts and western New York markets, it also now has the ability to do NMTC transactions anywhere in the U.S. Projects must be in designated low-income areas (pre-qualified census tracts or specially-approved target areas).

The NMTC initiative is designed to mobilize up to \$15 billion in development capital based on a direct federal income tax credit of 39 percent spread over seven years. The program is already proving to be a powerful tool that is helping underserved communities attract smart capital to good projects on favorable terms and is allowing investors to book new business with enhanced returns, while helping create greater opportunities for low-income communities. The program is very flexible and allows the tax credits to be structured into a deal in a variety of ways to best meet the needs of the investors (banks

and private equity), borrowers (project), and the sponsor (CEI). The tax credits, for instance, can be used to enhance an investor's Internal Rate of Return, provide a borrower with access to debt at a reduced interest rate (typically 1.00-3.00% below market), and/or repay equity investors with tax credits as opposed to actual cash. The financial success of a project depends on balancing all of the interests so that all needs are met.

The types of business investments eligible under the NMTC program are very broad, allowing virtually any real estate project or operating business. (Please note that there are some exceptions to this eligibility, such as insurance companies and others.) Projects can be undertaken by either for profit or nonprofit entities. As of August 1, 2005, CEI had closed eight high-impact NMTC projects in the northeastern U.S. using \$106 million of NMTC investment capacity, triggering total private capital investment in low-income communities of over \$400 million, and committed to a ninth. The closed and funded transactions have absorbed 82% of CEI's total current NMTC investment capacity; CEI is seeking additional allocation of tax credit authority in a process to be completed in early 2006." ([www.ceimaine.com](http://www.ceimaine.com), 3/29/2006)

#### Project Components for NMTC Model:

- Project or business capital requirement of \$1 million to \$30 million (preferably over \$2 million)
- Deals in which “substantially all” (85%) of the capital can stay invested in the project for the seven year tax credit period (with acceptable refinance risk at the end of this seven years).
- The type of business investments eligible under the NMTC program is very broad allowing virtually any real estate project or operating business. Projects can be undertaken by either for-profit or nonprofit entities.
- CEI brings a mission-oriented perspective to underwriting proposed NMTC transactions. An evaluation of a project’s likelihood of financial success is only one element that is considered. Other important aspects are:
  - Strong economic development impact (direct or indirect), such as helping to create or retain jobs; acting as the catalyst for larger or additional development or redevelopment, infusing sources of new investment capital into an under-served, low income area; creating new access to community services
  - Positive social and environmental impacts that could include efforts such as providing new or expanded community services, creating or retaining jobs for low-income people, using recycled materials, increasing energy efficiency, advancing “green” building concepts, supporting sustainable forestry, etc.
  - [www.ceimaine.org](http://www.ceimaine.org)

#### CEI’s Investment Themes

- Natural Resource-Based Development Investments: Investments in operating companies utilizing sustainably-managed natural resources as key assets in their businesses, often in rural areas, creating value-added products- working forests, pulp and paper



companies, wood products companies, small farms, waterfront and marine businesses, recreational tourism ventures, and supporting industries. (One of the themes)

[www.ceimaine.org](http://www.ceimaine.org)

NMTC are available throughout the River Valley. Mainly located in Rumford and Mexico, they are also available in Andover, Byron, Peru, and Dixfield. Please refer to maps for exact areas.

Availability of Pine Tree Zones:

Maine's eight Pine Tree Zones, introduced by Governor John E. Baldacci, provide new and improve existing employment opportunities, broaden the tax base, and stimulate the economy through the creation of new jobs. The Zones offer benefits and incentives to qualified businesses that locate within one of the Zones throughout the State. Few other states offer the kind of economic benefits and enterprise opportunities comparable with Maine's Pine Tree Zone Program. Maine offers a highly skilled workforce, telecommunications infrastructure, affordable wage scale, and wonderful quality of life. It is an attractive place to do business. The eight Pine Tree Zones are:

- Aroostook County
- Androscoggin Valley- (River Valley Area)
- Penobscot Valley
- Downeast
- Kennebec Valley
- Midcoast
- Penobscot/ Piscataquis (PenQuis)
- Southern Maine

The benefits offered to qualified businesses locating within one of the Pine Tree Zones are:

- Employment Tax Increment Financing (TIF) that returns 80% of State income taxes from qualified new employees for up to 10 years
- 100% refund of corporate income tax and insurance premium tax for years one through five and 50% for the remaining five.
- Local option Tax Increment Financing that does not count against a municipality's existing TIF area and value caps
- 100% sales and use tax exemption for construction materials and equipment purchases, effective July 1, 2005
- Reduced Electric rates

Examples of qualified business categories:

- Financial Services
- Manufacturing

- Advanced Technologies for Forestry and Agriculture
- Aquaculture and Marine Tecnology
- Biotechnology
- Composite Materials
- Environmental Technology
- Information Technology
- Precision Manufacturing
- *(Pamphlet produced by: Maine Department of Economic and Community Development)*

### **Site Profiles & Graphics**

#### Baileyville/Woodland:

Baileyville is located in Washington County, Maine. Baileyville has several attributes that make it an excellent location to place a biorefinery. The sites in Baileyville that are under consideration are the Baileyville Industrial Park- 470 acres and the Woodland Commercial Park- 3, 12 acre lots. The Woodland Commercial Park is part of the Atlantic Northeast International Trade Center which facilitates business between Canada and Maine. There are currently plans underway to construct an International bridge over the St. Croix River to Canada. Because of this, the park is considered a foreign trade zone and has the benefits associated with such a title. The park has 3-phase power, water, sewer, storm sewer, telecommunication, ISDN, waste disposal on site, is a hub zone, is 8 miles from the Maritime Northeast Natural Gas Pipeline, property tax for the park is \$0.46/sq. ft., and the park is 5 minutes from the Calais Industrial Park which has container shuttle links between the two parks with rail siding planned for the near future. Baileyville is located only 33 miles from Eastport which is one of Maine’s deep sea ports and also has rail siding available. Major highways US1 and US9 run through Baileyville and Pine Tree Zones are available at any site in town. Eastern Maine Electric Cooperative holds the local power grid in the area. The population in Baileyville according to the last U.S. Census is 1,994.

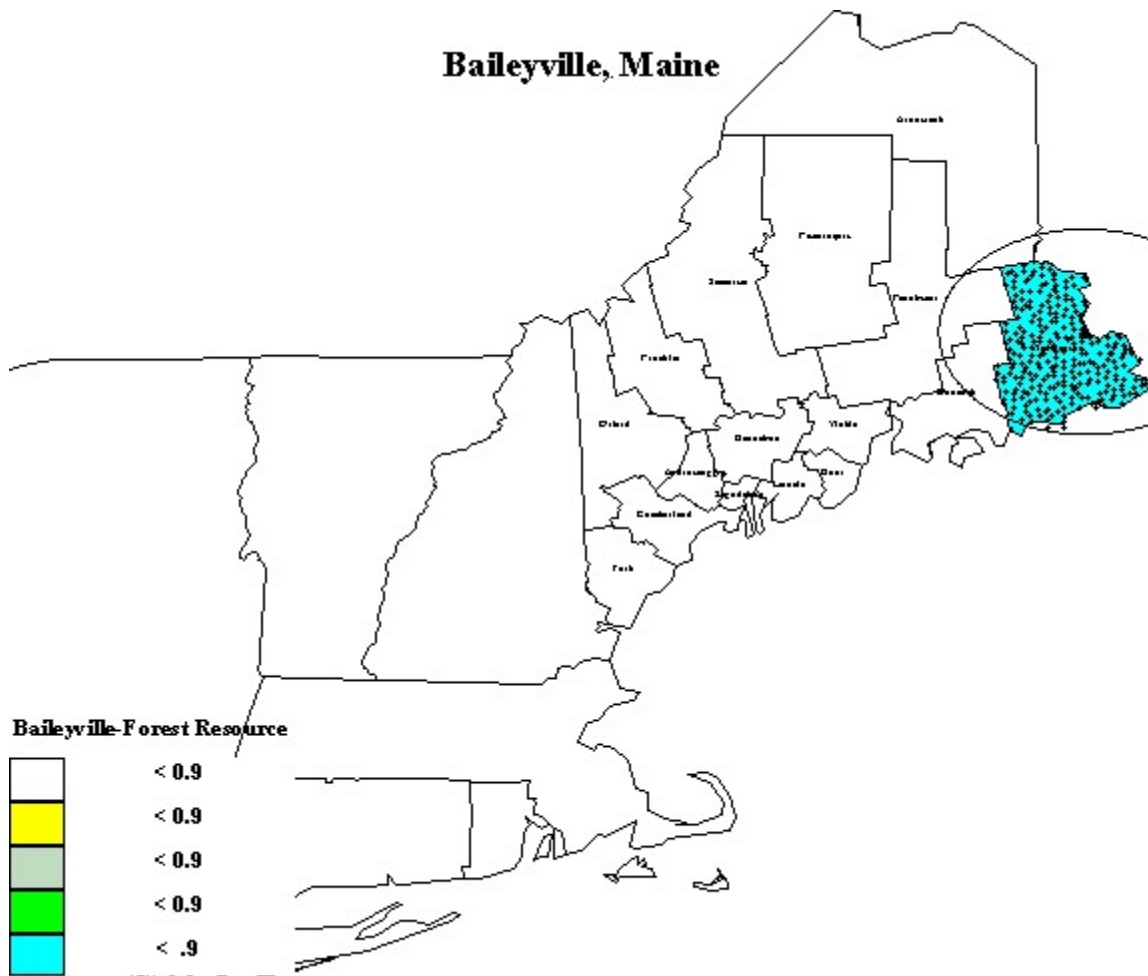
Washington County’s unemployment rate in 2005 was 8.4% and in 2006 it rose to 9.4%. A very high unemployment rate means high worker availability. Baileyville’s unemployment rate as of July 2006 was 10.8% and the current labor market is 869. The largest employers in the area are Georgia Pacific (Domtar) and Irving Convenience. Employment in the Forestry industry has been steadily decreasing in Washington County since 2001. See chart 1.1 below<sup>2</sup>

Year	Employment	Turnover Rate
2001	505	16.8%

<sup>2</sup> <http://www.maine.gov>, Maine’s LED Data, September 15, 2006.

2002	419	11.7%
2003	363	11%
2004	340	14.7%
2005	268	N/A

Washington County has the second largest amount of hardwood logging residue at 155,800 tons/year in the state.<sup>3</sup>



Area of forestland(acres) divided by the total area of land in each County code( acres).<sup>4</sup>

<sup>3</sup> [http://www.mainefdc.org/pdf/full\\_report.pdf](http://www.mainefdc.org/pdf/full_report.pdf), Robert J. Evans & Doris M. McCormick, *River Valley Biomass Refinery Study*, January 25, 2006, 37.

<sup>4</sup> <http://ncrs2.fs.fed.us/4801/fiadb/index.htm>, USDA Forest Inventory Mapmaker 2.1, 9/29/06.



**Baileyville, Maine. Domtar and Baileyville Industrial Park**

Bucksport:

Bucksport is located in Hancock County, Maine. Bucksport is a large city with the major highways US1A, 15, 3, 46, I-95, and 395 running through it. The Buckstown Heritage Park is under consideration for a biorefinery. This park has Pine Tree Zones available at any site, has rail access, water, sewer, 3 phase power, and the Maritime Northeast Natural Gas Pipeline running through it. The Buckstown Heritage Park also has free land available for qualified new businesses that locate there. IP located in Bucksport and Georgia Pacific located 33 mi. away in Old Town are the major producers of biomass in the area. Bucksport has a deep sea port at the mouth of the Penobscot River, Sprague Terminal, which is used as a fuel depot. This port has -29 MLW and a 700 ft. berthing capacity. Bucksport is the only location in Hancock County that has rail service for freight. Bucksport is only 12 miles from Searsport, another deep sea port with an intermodal facility, storage space- 1.6 million gallon tanks and 90,000 sq. ft. of warehouse, and 70 acres available for development. The tankers that use Searsport are from Canada, New York, etc. and they bring all types of petroleum products. The smallest barges hold 2 million gallons and the largest hold 9 million gallons. The rail service is provided by Montreal & Maine and the cars can hold between 34,500 and 37,500 gallons of liquid for shipment. Bucksport's population is 4,796.

The unemployment rate in 2005 in Hancock County was 5.5% and in 2006 it rose to 7.5%. Not a significantly high unemployment rate, but it must be noted that Bucksport is located within 30 miles of several other very large cities which will provide a sufficient workforce. The Bangor MSA (Bangor, Old Town, Orono) unemployment rate in 2005 was 4.7%, and in 2006 thus far is 4.9%. Employment in the Forest Industry in Hancock County has decreased since 2001 but has stabilized in the past couple of years. See chart below:<sup>5</sup>

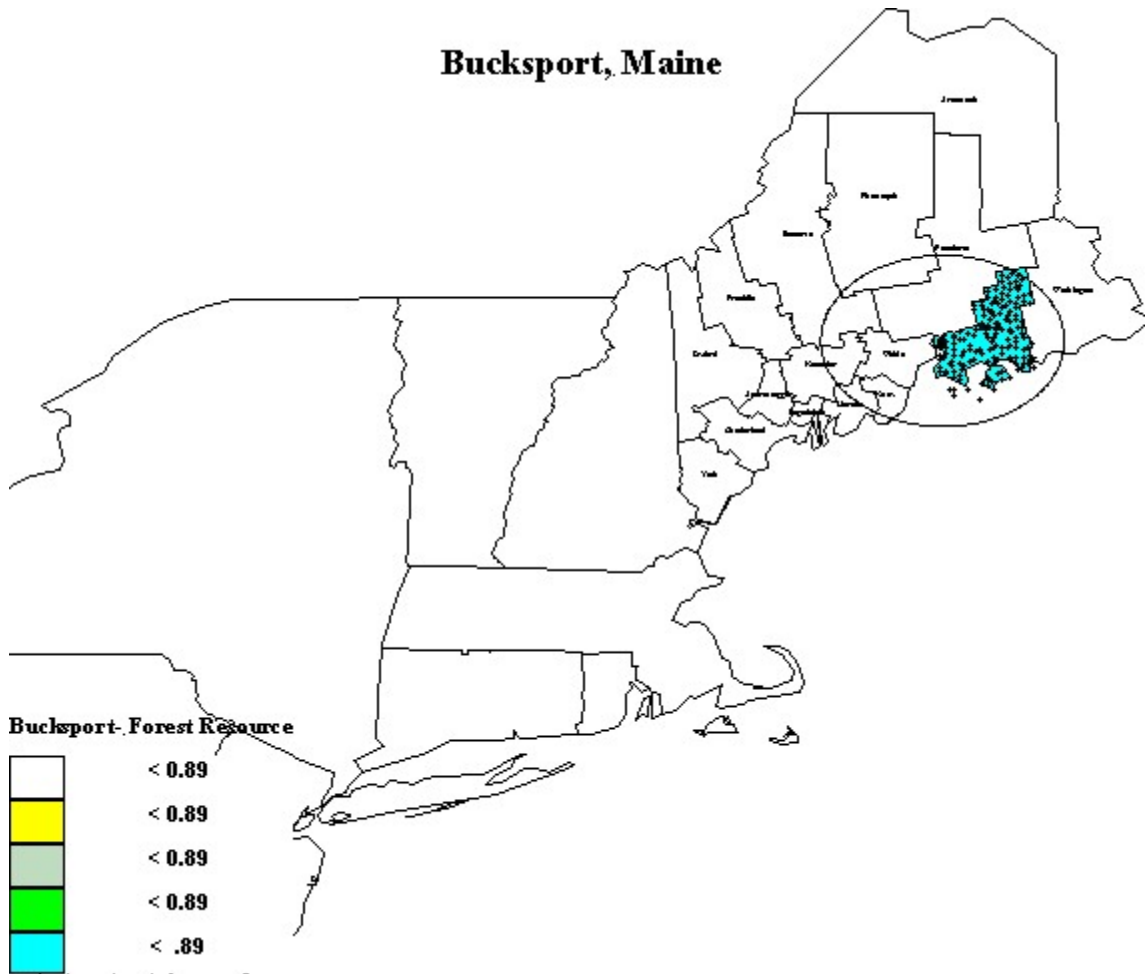
Year	Employment	Turnover Rate
2001	223	16.5%
2002	169	14.7%
2003	152	13.8%
2004	159	11.6%
2005	155	N/A

Hancock County has an average amount of both softwood and hardwood logging residue, 41,000 tons/year and 23,800 tons/year respectively.<sup>6</sup>

<sup>5</sup> <http://www.maine.gov>, Maine's LED Data, September 15, 2006.

<sup>6</sup> [http://www.mainefdc.org/pdf/full\\_report.pdf](http://www.mainefdc.org/pdf/full_report.pdf), Robert J. Evans & Doris M. McCormick, *River Valley Biomass Refinery Study*, January 25, 2006, 38

# Bucksport, Maine

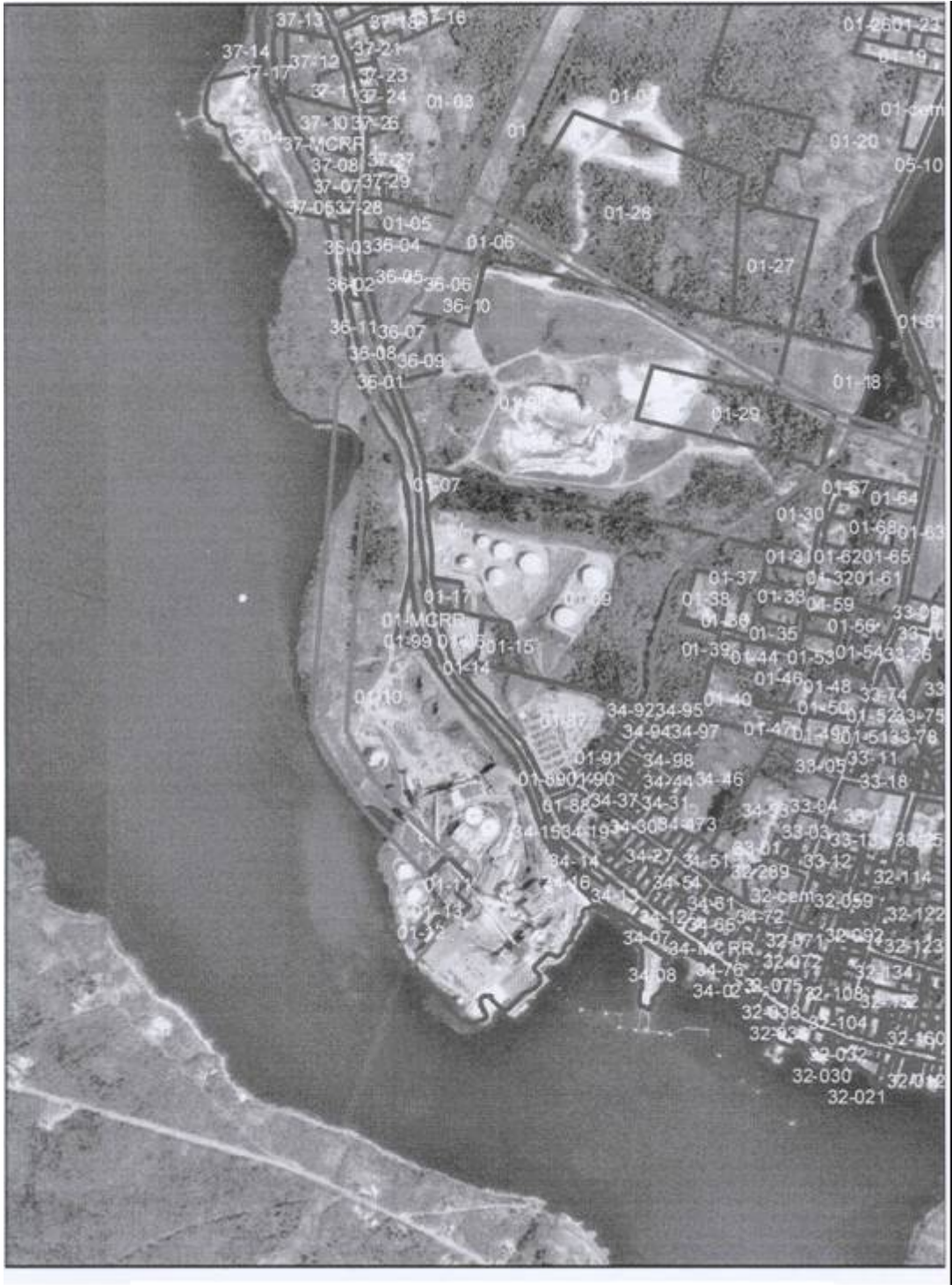


Area of forestland(acres) divided by the total area of land in each County code( acres).<sup>7</sup>

<sup>7</sup> <http://ncrs2.fs.fed.us/4801/fiadb/index.htm> ,USDA Forest Inventory Mapmaker 2.1, 9/29/06



**Bucksport- International Paper**



Bucksport- Tax Map Property Lines





**Bucksport- International Paper and Buckstowm Heritage Park**



**Bucksport, Maine- International Paper**



**Buckstown Heritage Park, Bucksport**

Jay:

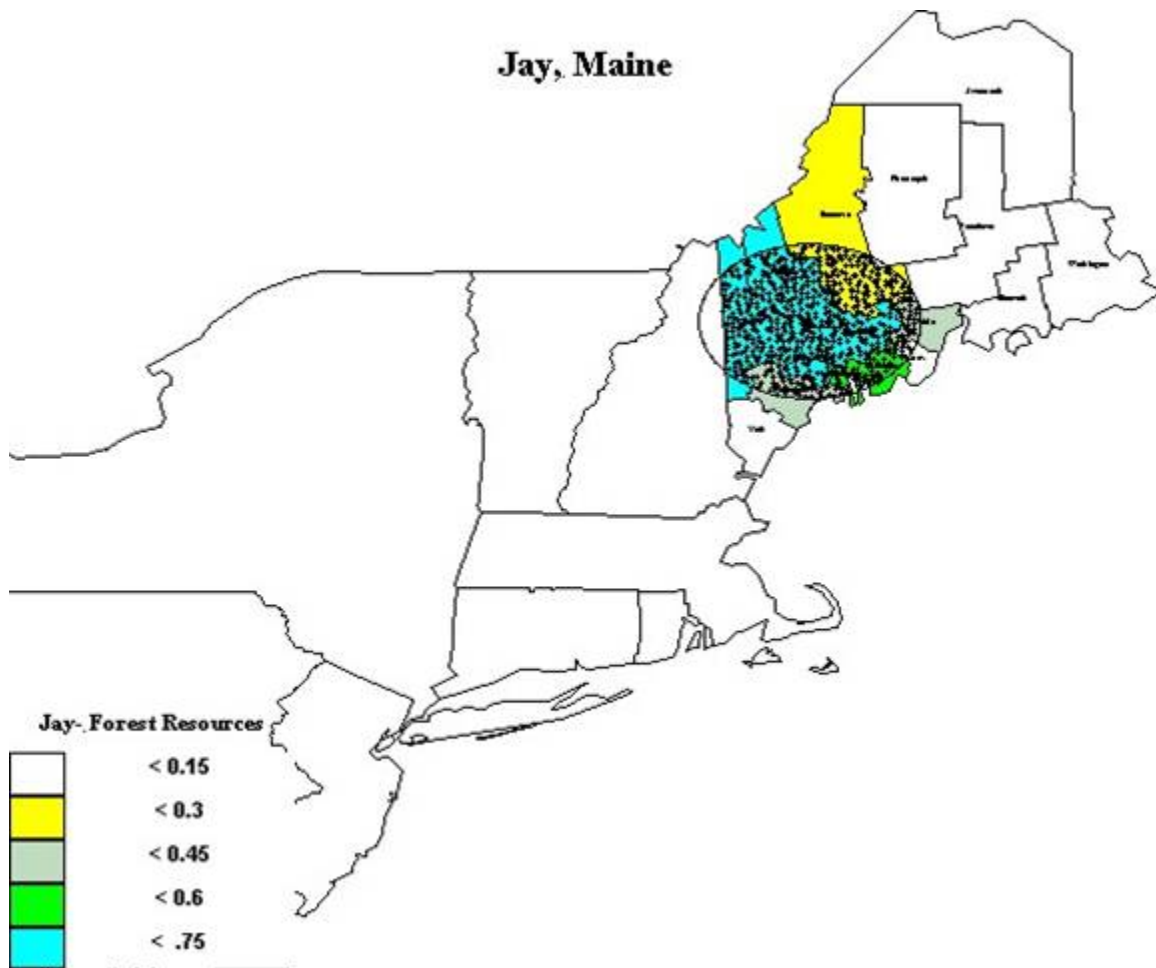
Jay is located in Franklin County, Maine. Major Highways running through the town of Jay are US 2, 4, 140, 133, 156, and 17. Possible sites include the recently constructed Business Park located on major route 4, equidistance from IP and Wausau-Mosinee Paper with excess acreage ready for expansion. Water, sewer, and 3-phase power will be available. Jay is home to IP and Wausau-Mosinee Paper, two major biomass producers. Jay is also within close proximity to the Auburn Intermodal facility and the PNGTS natural gas pipeline. Pine Tree Zones are available at any site. Jay's strong industrial and forest based history make it a great fit. A rail spur is available at International Paper Company. Users of biomass in the area are the biomass plant, Borlux, in Livermore Falls, IP, and Wausau-Mosinee Paper. There are also several small sawmills in the area and a larger sawmill, Isaacson Lumber. Jay's population is 5,802.

Franklin County's unemployment rate in 2005 was 5.7% and in 2006 it remained steady at 5.7%. Relatively low for the area, there are still several surrounding areas and a large workforce. Franklin County's employment in the forest industry had been decreasing since 2001 but recently has risen again. See chart below:<sup>8</sup>

Year	Employment	Turnover Rate
2001	313	11.8%
2002	255	10.2%
2003	210	10.8%
2004	191	18.1%
2005	241	N/A

---

<sup>8</sup> <http://www.maine.gov>, Maine's LED Data, September 15, 2006.



Area of forestland(acres) divided by the total area of land in each County code( acres).<sup>9</sup>

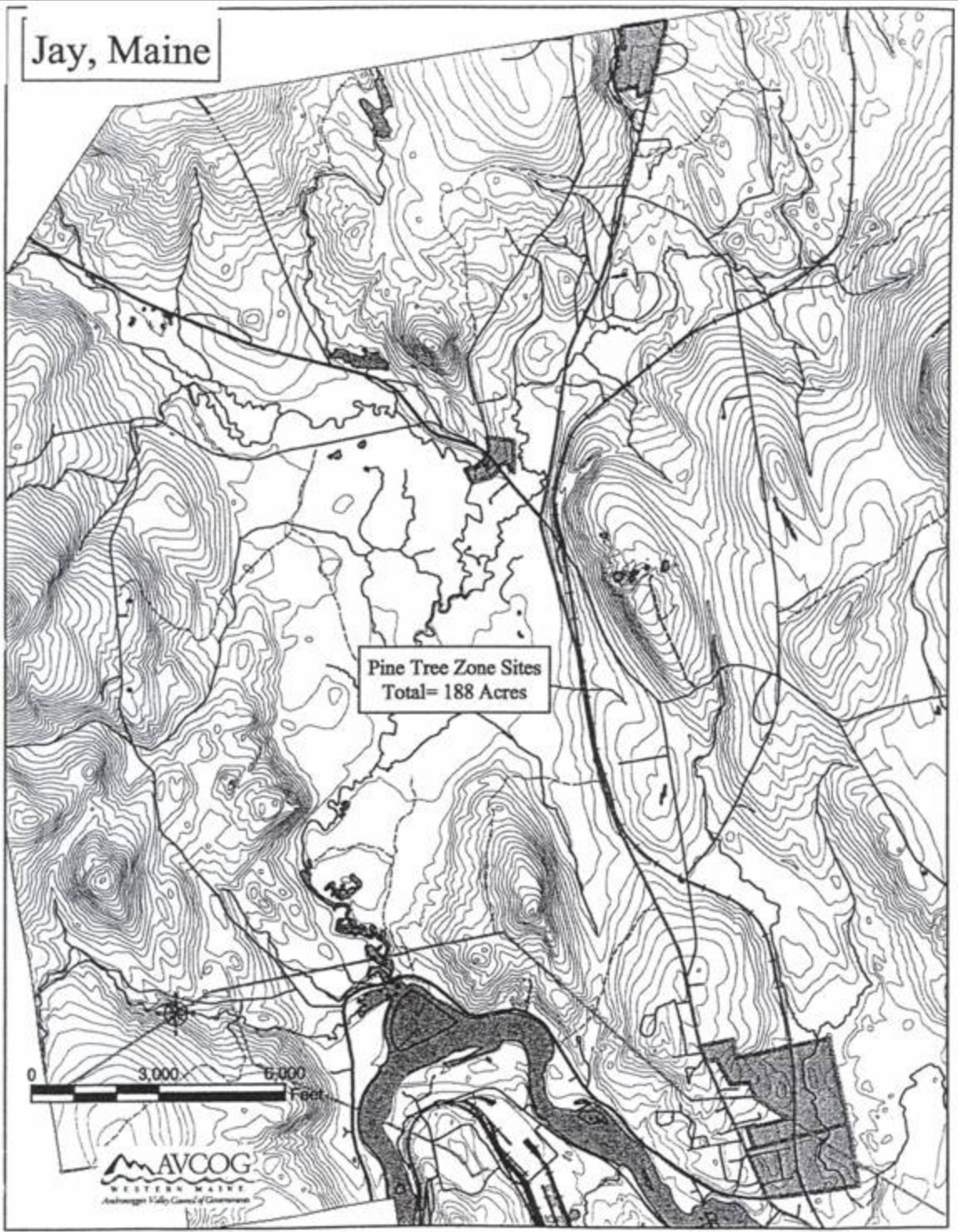
Franklin County produces 76,000 tons/year of hardwood logging residue and 42,000 tons/year of softwood.<sup>10</sup>

<sup>9</sup> <http://ncrs2.fs.fed.us/4801/fiadb/index.htm> ,USDA Forest Inventory Mapmaker 2.1, 9/29/06.

<sup>10</sup> [http://www.mainefdc.org/pdf/full\\_report.pdf](http://www.mainefdc.org/pdf/full_report.pdf), Robert J. Evans & Doris M. McCormick, *River Valley Biomass Refinery Study*, January 25, 2006, 37 & 38









Lincoln:

Lincoln is located in Penobscot County, Maine. As a small mill town, Lincoln has major highways US 2 and I-95 running through. The site under consideration is located on the land of Lincoln Paper and Tissue, Lincoln's major biomass producer/consumer. Water, power, sewer, biomass, and rail are available at this site. The rail is serviced by Maine Montreal & Atlantic. Pine Tree Zones are available. Lincoln is located in a heavily forested section of the state and is adjacent to large landholders which either own or manage the land such as GMO Renewables, Webber, and HC Haynes Inc. There are several sawmills present in the Lincoln area. Lincoln's population is 5,437.

Penobscot County's unemployment rate in 2005 was 5.1% and thus far in 2006 it has risen to 5.4%. Lincoln's unemployment rate in 2005 was 7.3% and slightly decreased in 2006 to 6.8%. In Penobscot County the forest industry employment history is large and has been quite steady for the past five years, this can be seen below:<sup>11</sup>

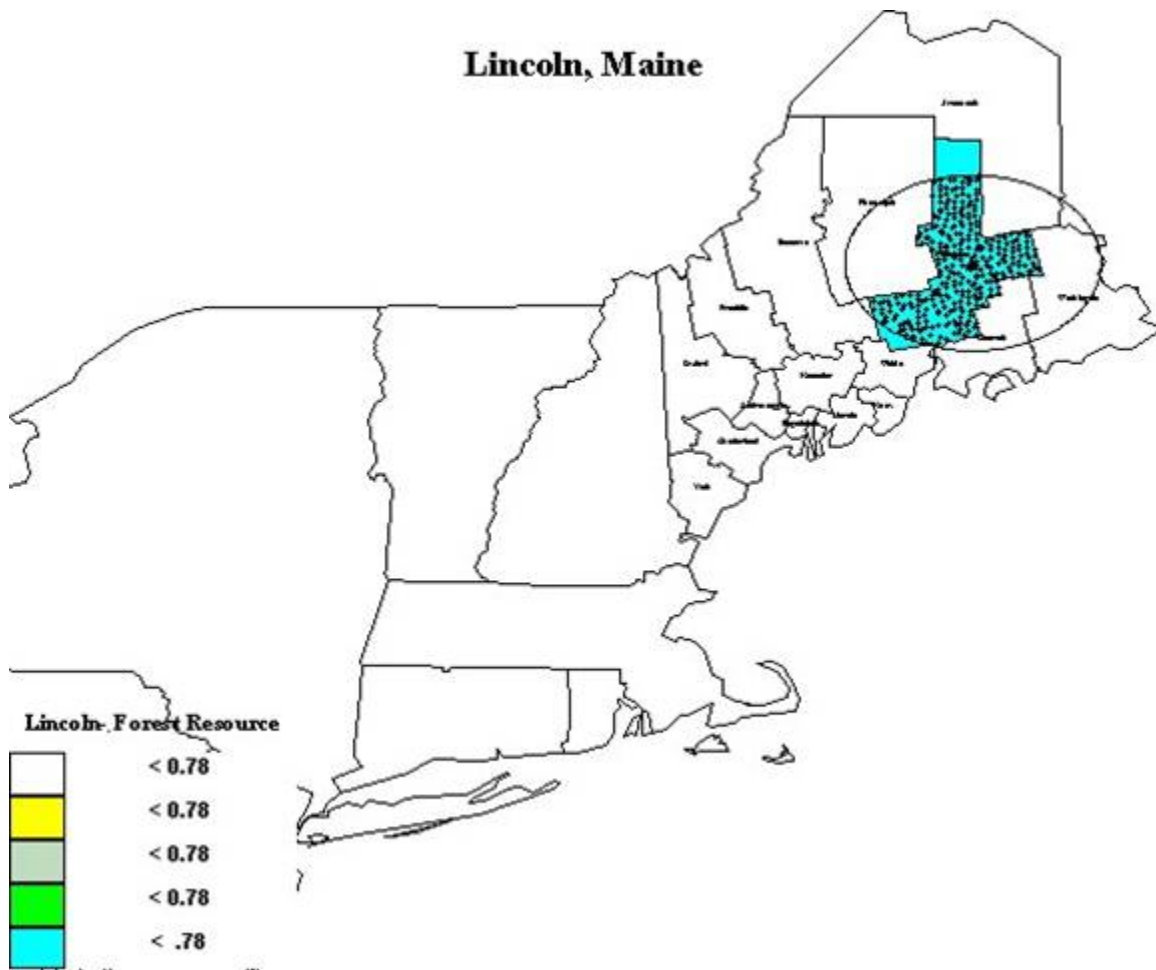
Year	Employment	Turnover Rate
2001	871	10.7%
2002	885	9.9%
2003	884	8.2%
2004	866	9.8%
2005	888	N/A

Penobscot County has the largest amount of softwood logging residue in tons/year at 170,000 in the state. It has a very large amount of hardwood logging residue at 123,8000 tons/year as well.<sup>12</sup>

---

<sup>11</sup> <http://www.maine.gov>, Maine's LED Data, September 15, 2006.

<sup>12</sup> [http://www.mainefdc.org/pdf/full\\_report.pdf](http://www.mainefdc.org/pdf/full_report.pdf), Robert J. Evans & Doris M. McCormick, *River Valley Biomass Refinery Study*, January 25, 2006, 37 & 38



Area of forestland(acres) divided by the total area of land in each County code( acres).<sup>13</sup>

The amount of biomass drain in the Lincoln is relatively low, as the major consumer, Lincoln Paper and Tissue, is a small operation. It is roughly 1,000 to 2,000 tons per day. Lincoln is situated in a definite “wood basket” and there is a significant amount of biomass available in spite of the consumers already located there.

<sup>13</sup> <http://ncrs2.fs.fed.us/4801/fiadb/index.htm> ,USDA Forest Inventory Mapmaker 2.1, 9/29/06.

John Holden 942-6389



Lincoln Industrial Park- Lincoln, Maine

Madison:

Madison is located in Somerset County, Maine. It has US 201, 202, and I-95 as its major transportation routes. There are several Guilford rail spurs located throughout the community and Pine Tree Zones are available at any site. The major biomass producers/consumers are Madison Paper, SAPPI, and Plum Creek. The Madison Business Gateway is the site under consideration for biorefinery placement. The Business Gateway has full infrastructure, water, power, sewer, fiber optics, underground high speed internet, and non-posted roads leading into the park. Madison Electric runs a 115KV power line and is a town owned utility with low rates. An interesting addition to the attributes in Madison is the recent construction of a 24 acre greenhouse by US Functional Foods. This greenhouse will house tomato plants with 20 ft. stalks and will require excess heat and CO<sup>2</sup>, major byproducts of a biorefinery. Plans for the greenhouse to build there own biomass plant for energy/heat, are underway for 2007. Madison also has a TIF policy which is a favored tax status. Madison's population is 4,523.

Somerset County's unemployment rate in 2005 was 7.6% and in 2006 thus far is 8.3%. With such a high unemployment rate there is definite worker availability. Somerset County's forest based employment history can be seen in the chart below:<sup>14</sup>

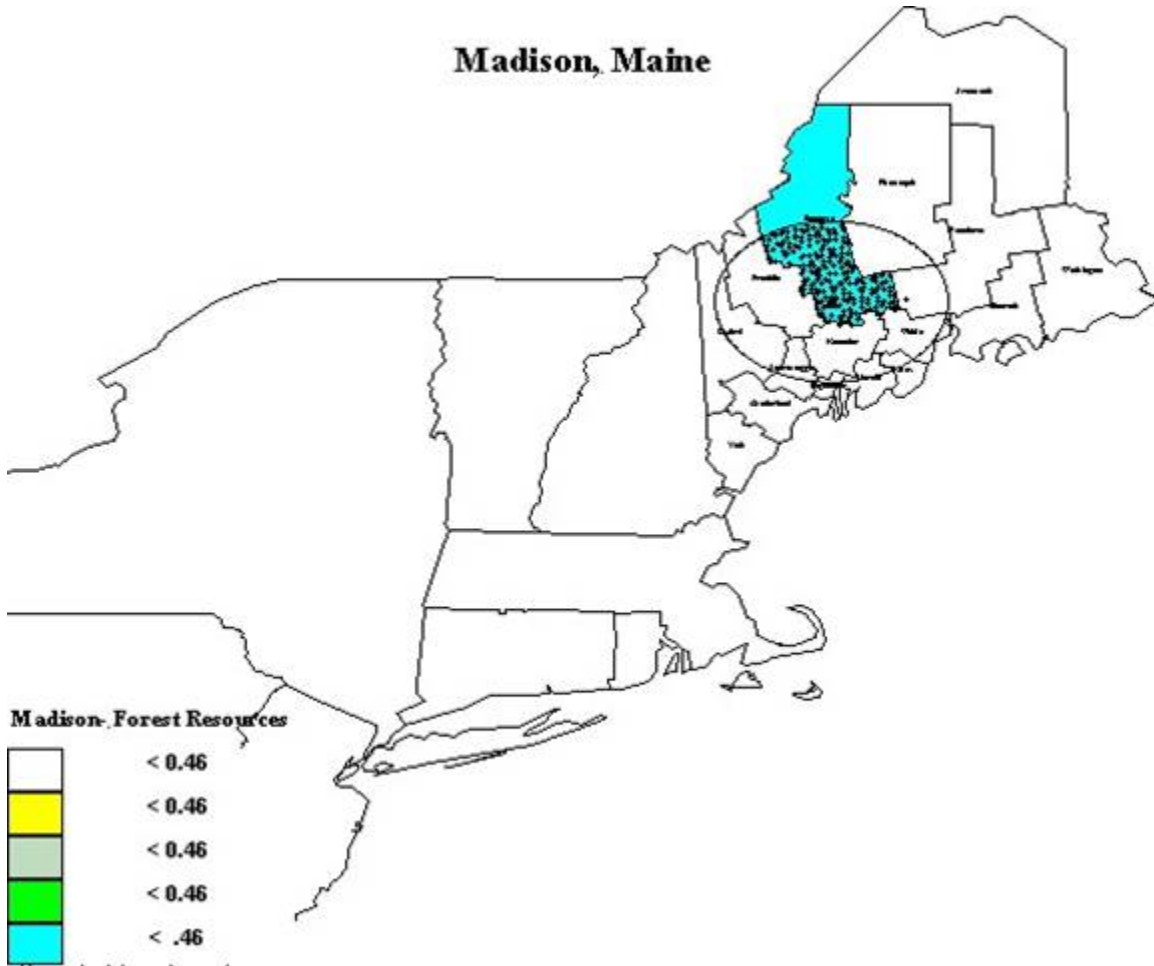
Year	Employment	Turnover Rate
2001	544	12.4%
2002	545	14.7%
2003	517	11.4%
2004	506	11.9%
2005	530	N/A

Somerset County has the largest amount of hardwood logging residue in the state at 162,900tons/year and a large amount of softwood logging residue at 123,000 tons/year.<sup>15</sup>

<sup>14</sup> <http://www.maine.gov>, Maine's LED Data, September 15, 2006.

<sup>15</sup> [http://www.mainefdc.org/pdf/full\\_report.pdf](http://www.mainefdc.org/pdf/full_report.pdf), Robert J. Evans & Doris M. McCormick, *River Valley Biomass Refinery Study*, January 25, 2006, 37 & 38

# Madison, Maine



Area of forestland(acres) divided by the total area of land in each County code( acres).<sup>16</sup>

<sup>16</sup> <http://ncrs2.fs.fed.us/4801/fiadb/index.htm> ,USDA Forest Inventory Mapmaker 2.1, 9/29/06.



**Madison, Maine- Property Tax Map**

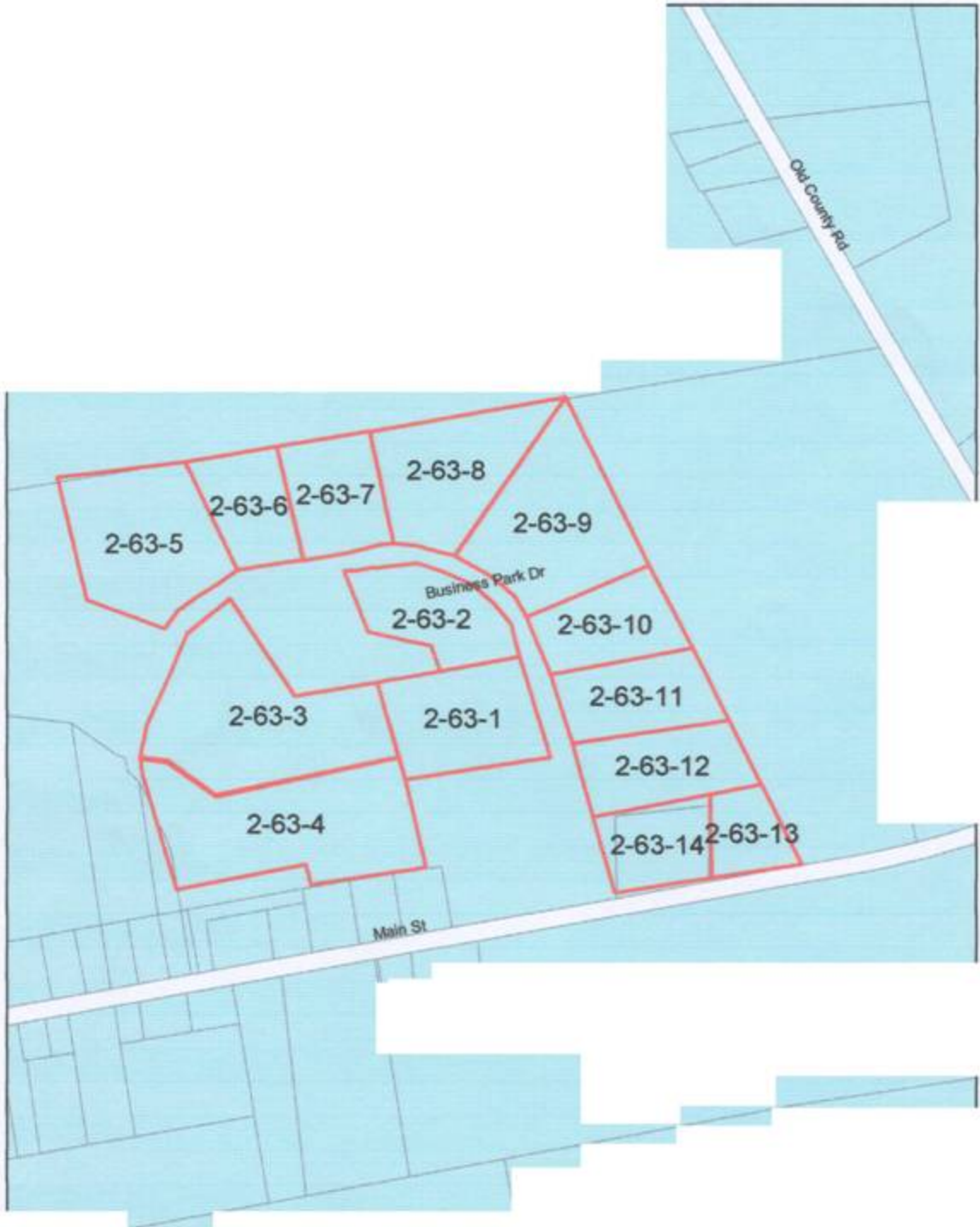


Madison, Maine- Madison Business Gateway

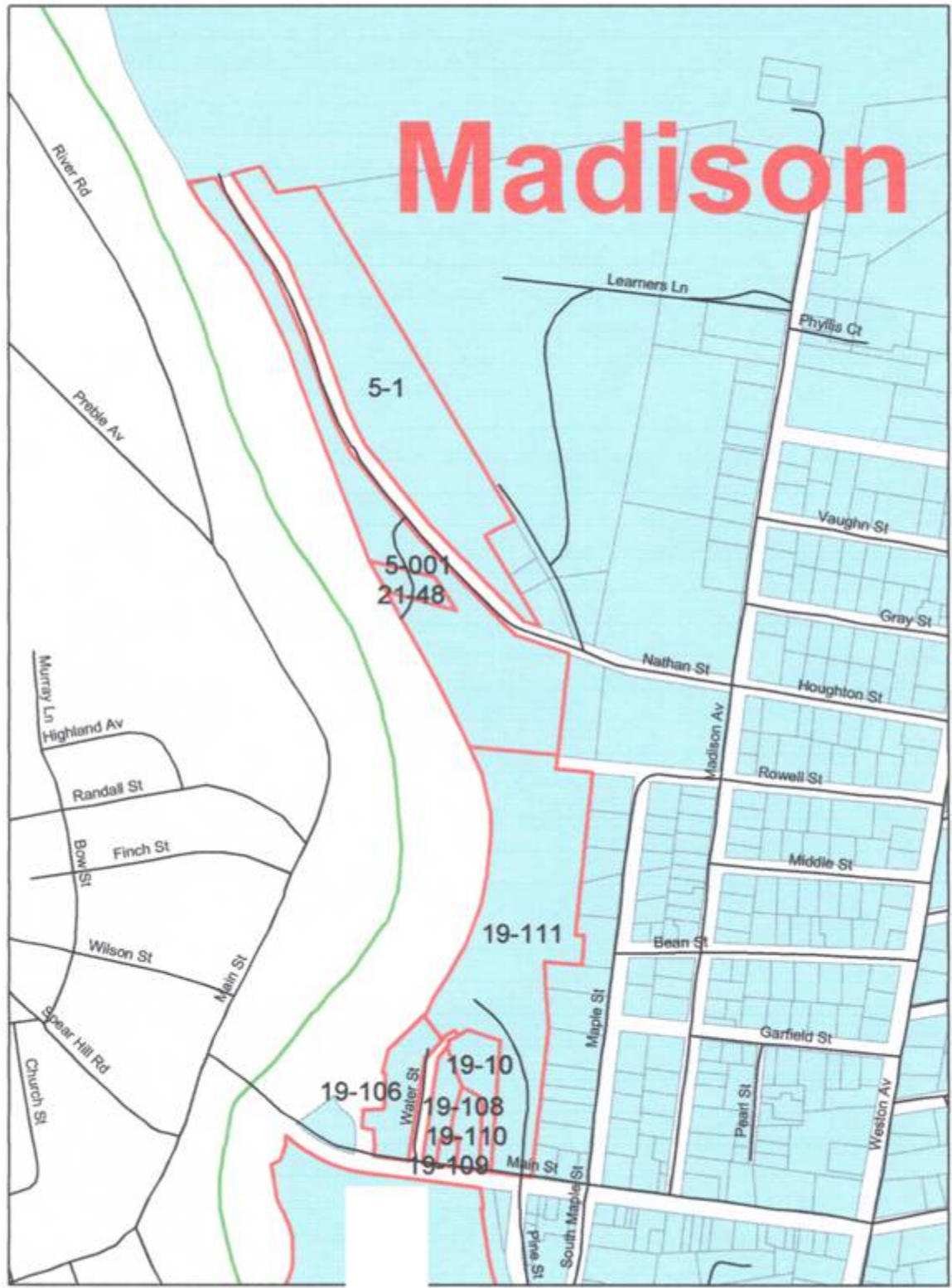


**Madison Business Gateway**





**Madison Business Gateway- Lot Availability**



**Madison, Maine**

*Millinocket:*

Millinocket is located in Penobscot County, Maine. It is less than 75 miles to the New Brunswick Border and has I-95 running through the community. Millinocket and East Millinocket are under consideration as Katahdin Paper has a mill in each town and are the major biomass producers/consumers in the area. The J.M. Huber Park is a potential site for a biorefinery. This park was created specifically for wood products, mills, and manufacturers. A main line of the Montreal Maine & Atlantic rail runs through the park and Pine Tree Zones are available at any site. There is a sawmill present within the park, Huber Resource's Hardwood Optimization Facility, offers a steady, centralized supply of hardwood sawlogs and other additional biomass from the Gardner Chip Mill, LLC. The park is 295 acres, and has no water at this time but is located over an aquifer so acquiring it should be a minimal hassle. Power and Sewer will be available shortly within the Huber Park. Many of the sites, specifically a 20 acre site located on the rail line, are DEP licensed lots which is an enormous benefit because of savings in time and money for permitting. Every lot in the Huber Park is directly connected to Maine's "wood Basket" by the Off-Highway Road System which could lead to significant transportation savings. This road system provides access to over 3 million acres of timberlands. Millinocket is surrounded by large land holdings managed or owned by Katahdin Timberlands, Prentiss & Carlisle Mgmt, Webber, and the Passamaquoddy Tribe. The Millinocket population is 6,441 and East Millinocket is 1,973.

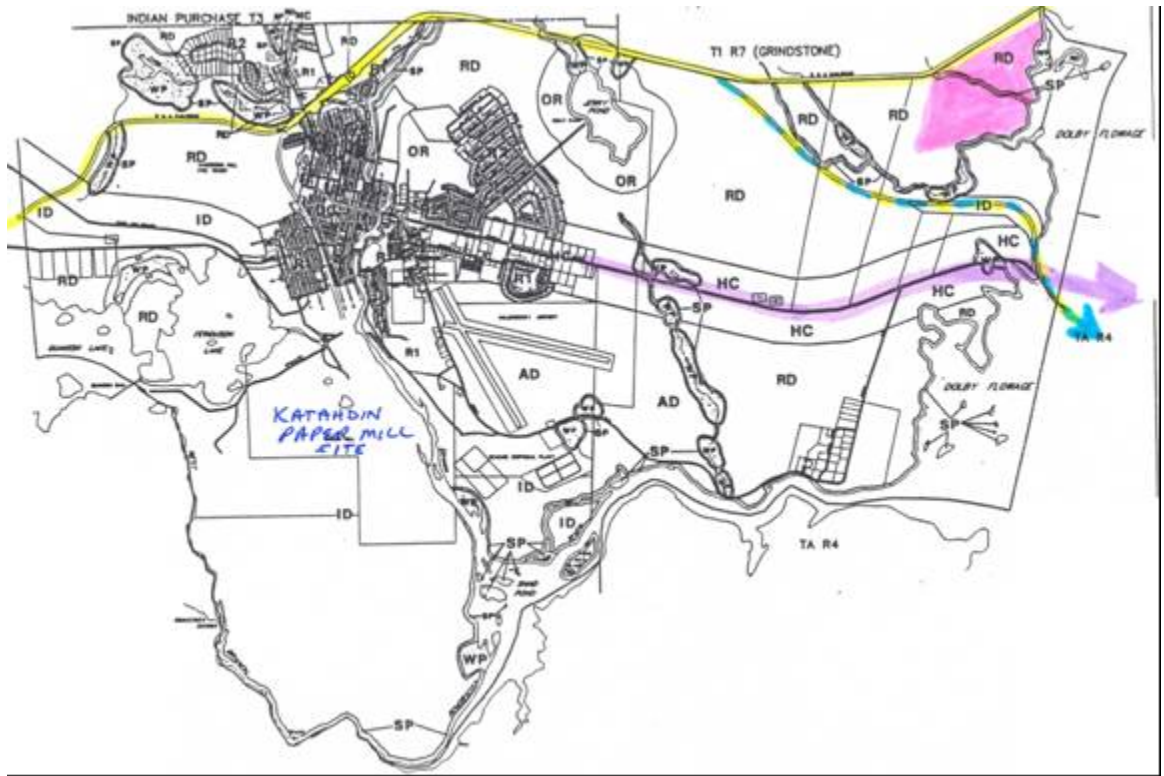
Millinocket or East Millinocket have in recent years announced shut downs or closing of the mills located in their communities. This area is in major need of an additional biomass contingent for the business and new infusion of capital. This also will mean a higher, more experienced worker availability.

Somerset County's unemployment rate in 2005 was 7.6% and in 2006 thus far is 8.3%. With such a high unemployment rate there is definite worker availability. Somerset County's forest based employment history can be seen in the chart above.

Somerset County has the largest amount of hardwood logging residue in the state at 162,900 tons/year and a large amount of softwood logging residue at 123,000 tons/year.<sup>17</sup>

---

<sup>17</sup> [http://www.mainefdc.org/pdf/full\\_report.pdf](http://www.mainefdc.org/pdf/full_report.pdf), Robert J. Evans & Doris M. McCormick, *River Valley Biomass Refinery Study*, January 25, 2006, 37 & 38

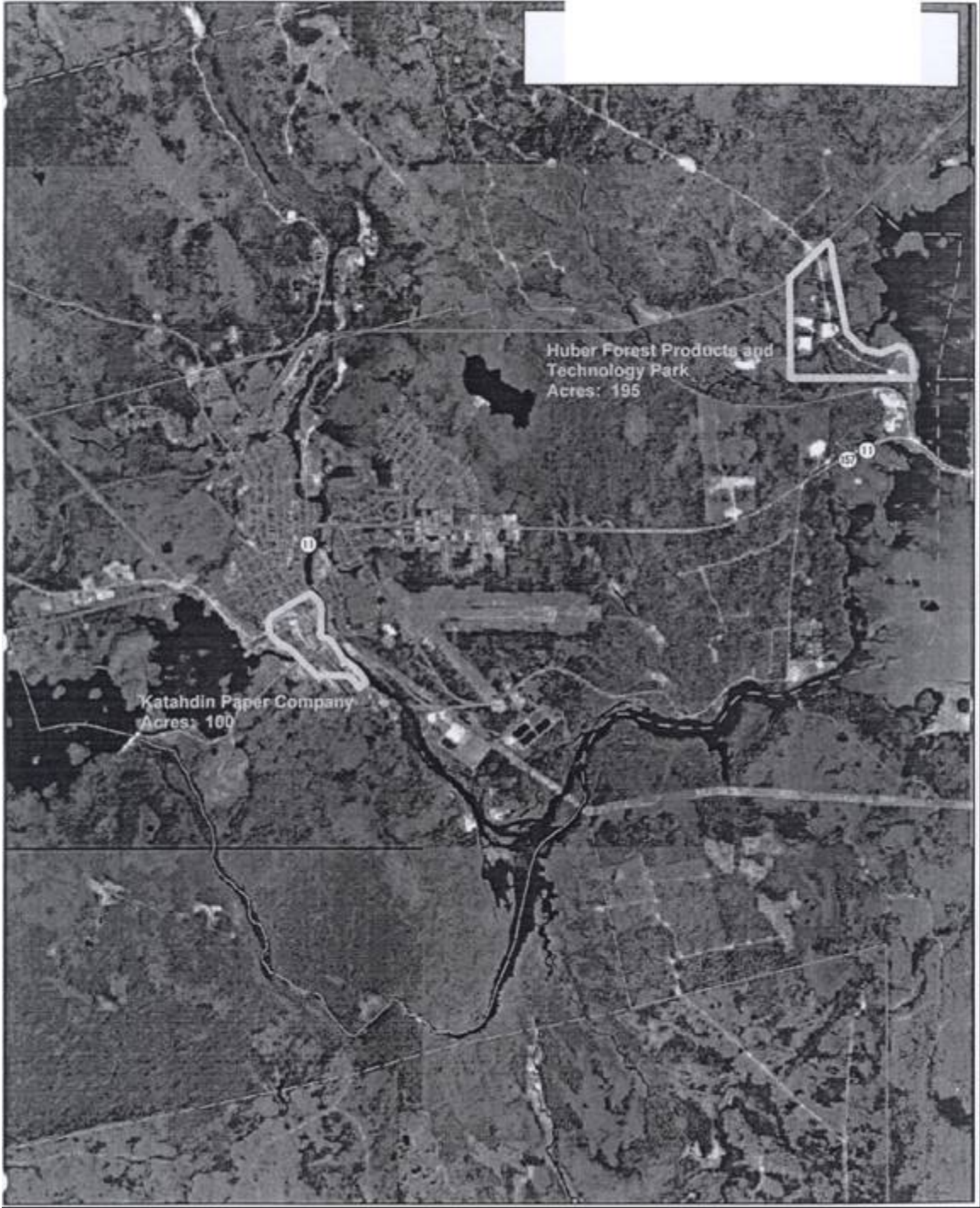


Millinocket, Maine- Katahdin Paper Mill and J.M. Huber Business Park

Bruce McLean 723-7300



Millinocket, Maine- Katahdin Regional Industrial Park

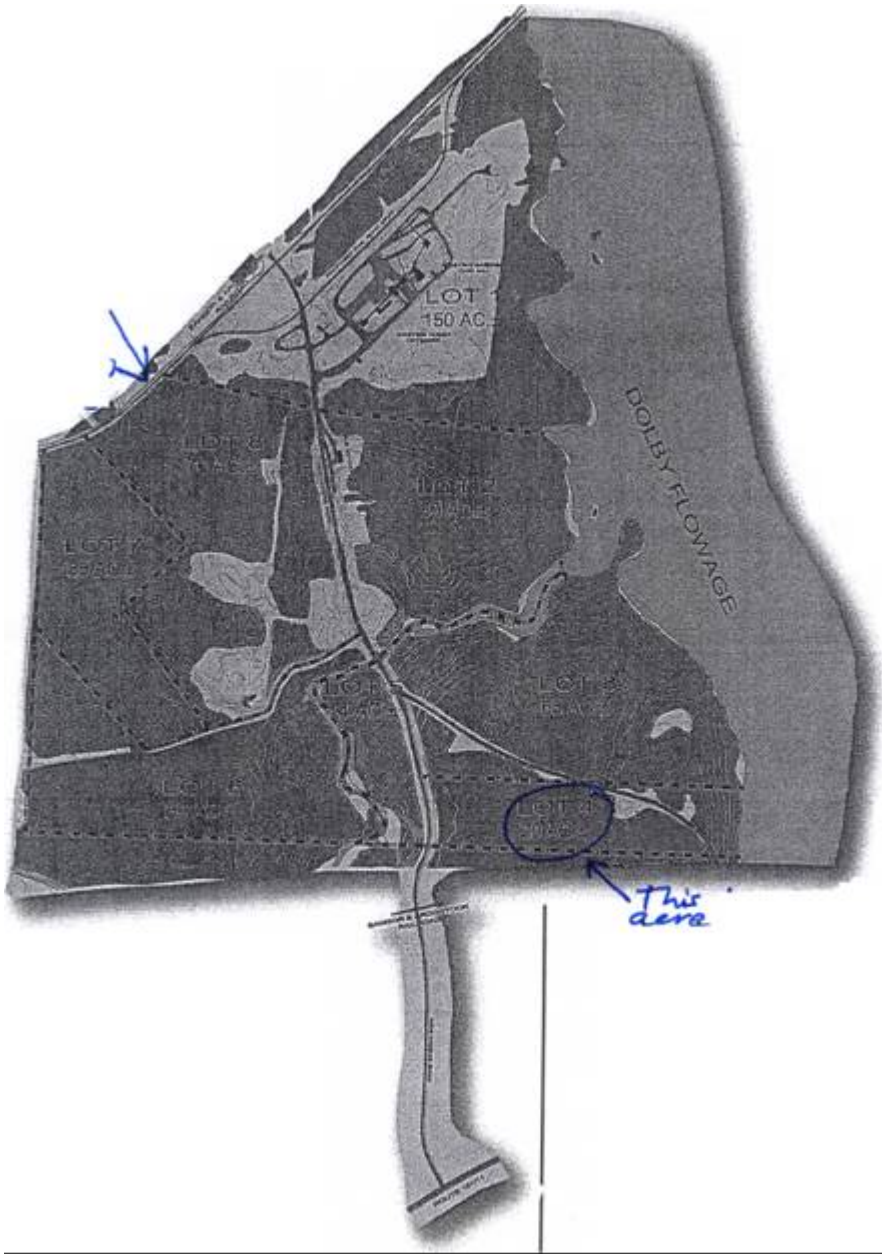


**Millinocket, Maine- J.M. Huber Industrial Park in relation to Katahdin Paper Company**

# **Huber** *forest* *Products* & **TECHNOLOGY PARK**

- 1996
- 1997
- 1998
- 1999
- 2000

*Every lot in Huber Forest Products  
& Technology Park is directly  
connected to Maine's "wood basket"  
by the Off-Highway Road System.  
With today's high cost of trans-  
portation, the savings from large  
capacity off-highway hauling  
are very significant.*



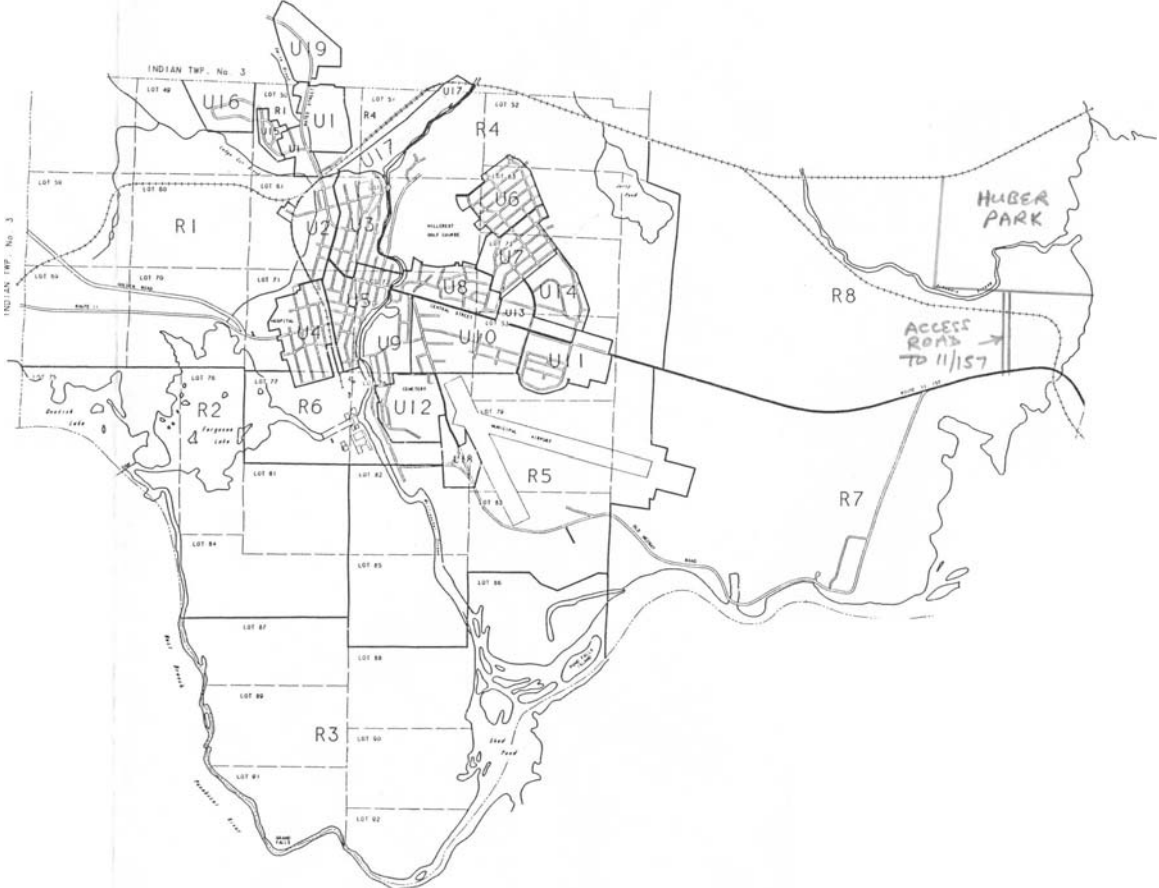
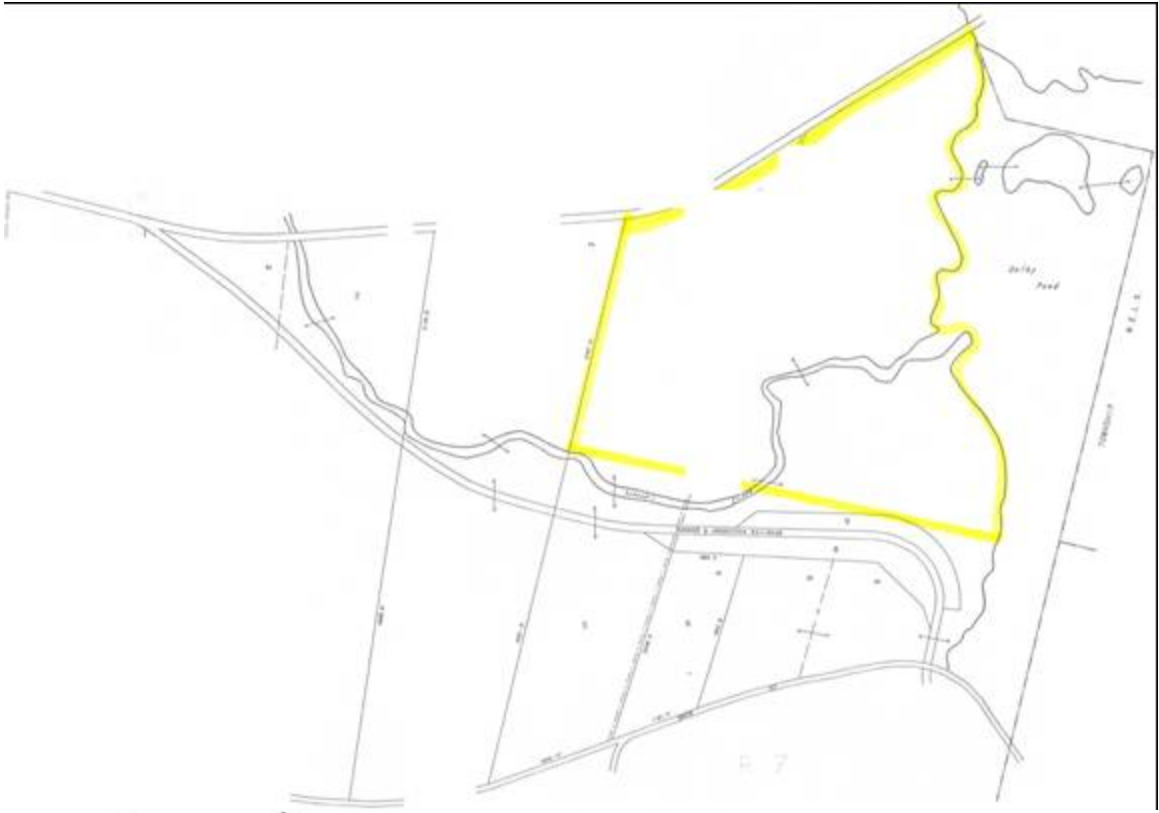
on Maine's timber resource.

## LOCATION

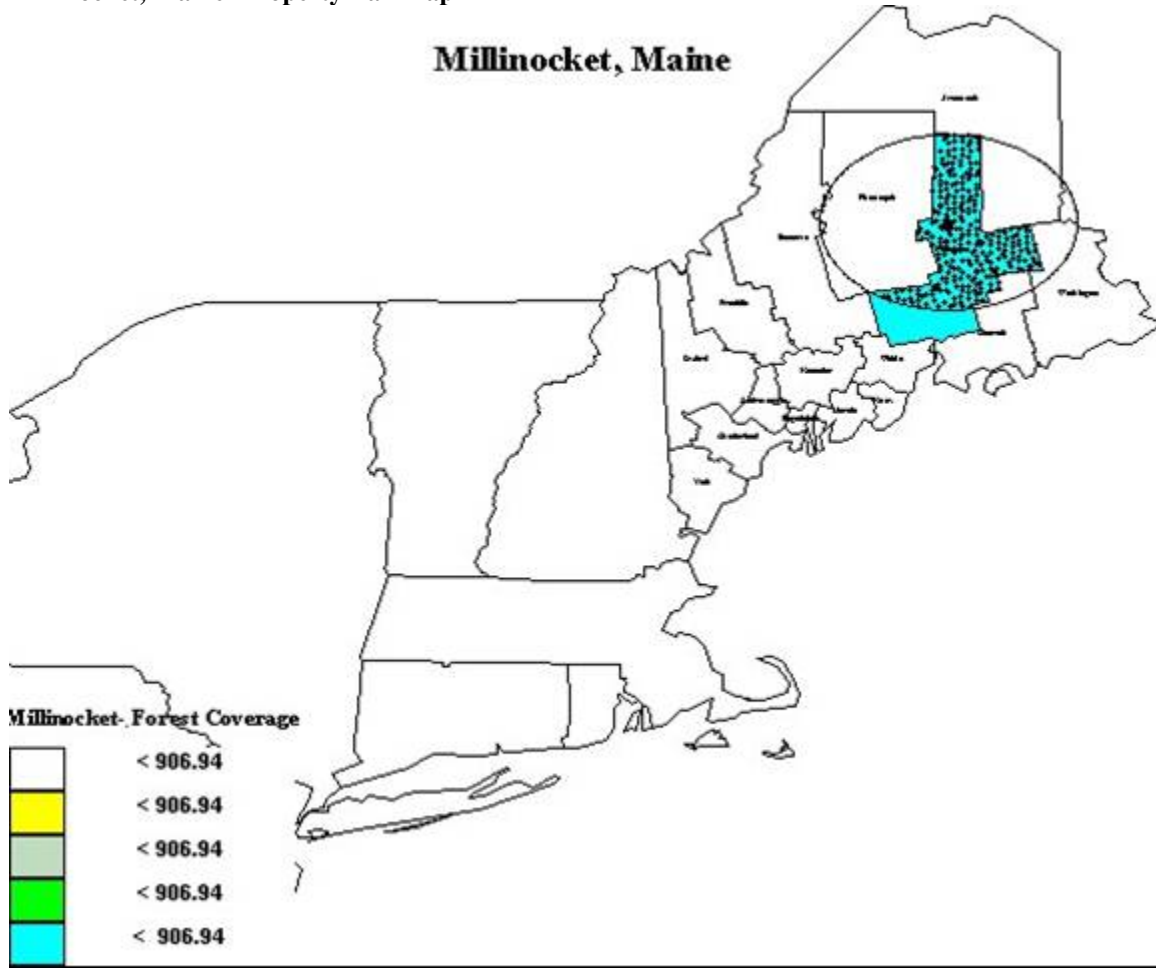
*tion Central.* The Huber Forest Products & Park is connected to Maine's extensive Off-High with access to 3 million acres of timberlands & Aroostook Railroad runs directly through north and center. The Park's entrance files from I-95.

**J.M. Huber Industrial Park- Millinocket, Maine. Potential lot.**





Millinocket, Maine- Property Tax Map



Area of forestland(acres) divided by the total area of land in each County code( acres).<sup>18</sup>

<sup>18</sup> <http://ncrs2.fs.fed.us/4801/fiadb/index.htm> ,USDA Forest Inventory Mapmaker 2.1, 9/29/06.

Portage:

Portage is located in Aroostook County, Maine. Right off I-95 and US1, Portage is in close proximity to the Canadian Border and 20 miles from the Presque Isle Intermodal Facility. Ashland a neighboring town is considered to be the access point to 3.8 million acres of forest land. Seven Islands, a land management company for the Pingree family is willing to provide access, feedstock, and shipment of finished product to either Searsport or Canada. Aroostook County is ranked first in the state in amount of harvested timberland. Bangor & Aroostook rail access is available. Fraser Papers Inc., located in Madawaska, is the major biomass producer/consumer in the area. There are several sawmills in the area, but northern Maine sawmills face challenges operating in the shadow of their Canadian competitors. A biorefinery would provide more of a market for production of biomass in Northern Maine. A potential site would be the Machias River Industrial Park which has water, power, sewer, and steam. Portage population is 1,999.

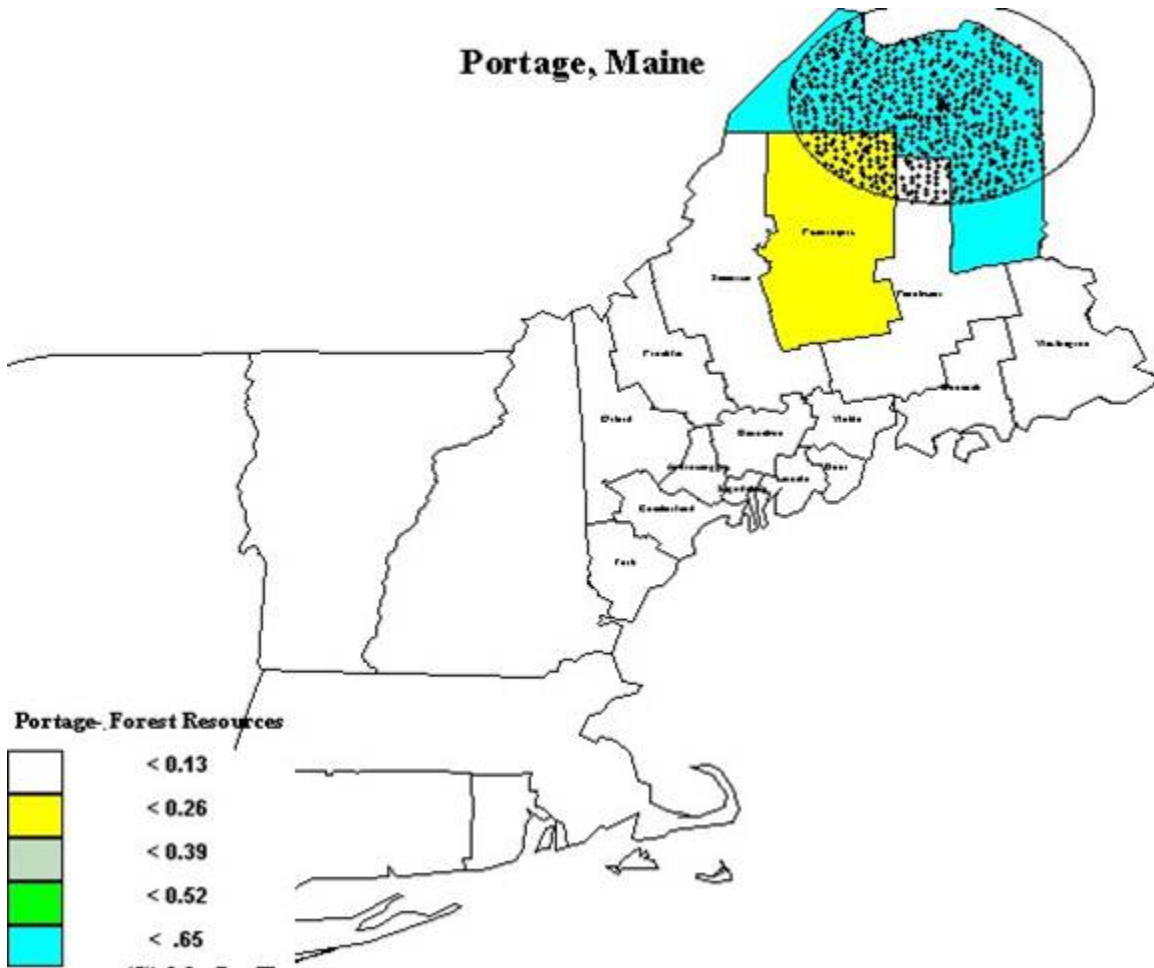
Aroostook County's unemployment rate in 2005 was 4.9% and in 2006 is 6.7%. Rising unemployment rates indicate a high worker availability. Aroostook County's employment in the forest industry has been steadily rising since 2001. See chart below:<sup>19</sup>

Year	Employment	Turnover Rate
2001	1,315	17.9%
2002	1,297	18.3%
2003	1,300	17.4%
2004	1,415	18.8%
2005	1,437	N/A

Aroostook County has very large amounts of softwood logging residue at 136,000 tons/year and average amounts of hardwood logging residue at 47,400 tons/year.<sup>20</sup>

<sup>19</sup> <http://www.maine.gov>, Maine's LED Data, September 15, 2006.

<sup>20</sup> [http://www.mainefdc.org/pdf/full\\_report.pdf](http://www.mainefdc.org/pdf/full_report.pdf), Robert J. Evans & Doris M. McCormick, *River Valley Biomass Refinery Study*, January 25, 2006, 37 & 38

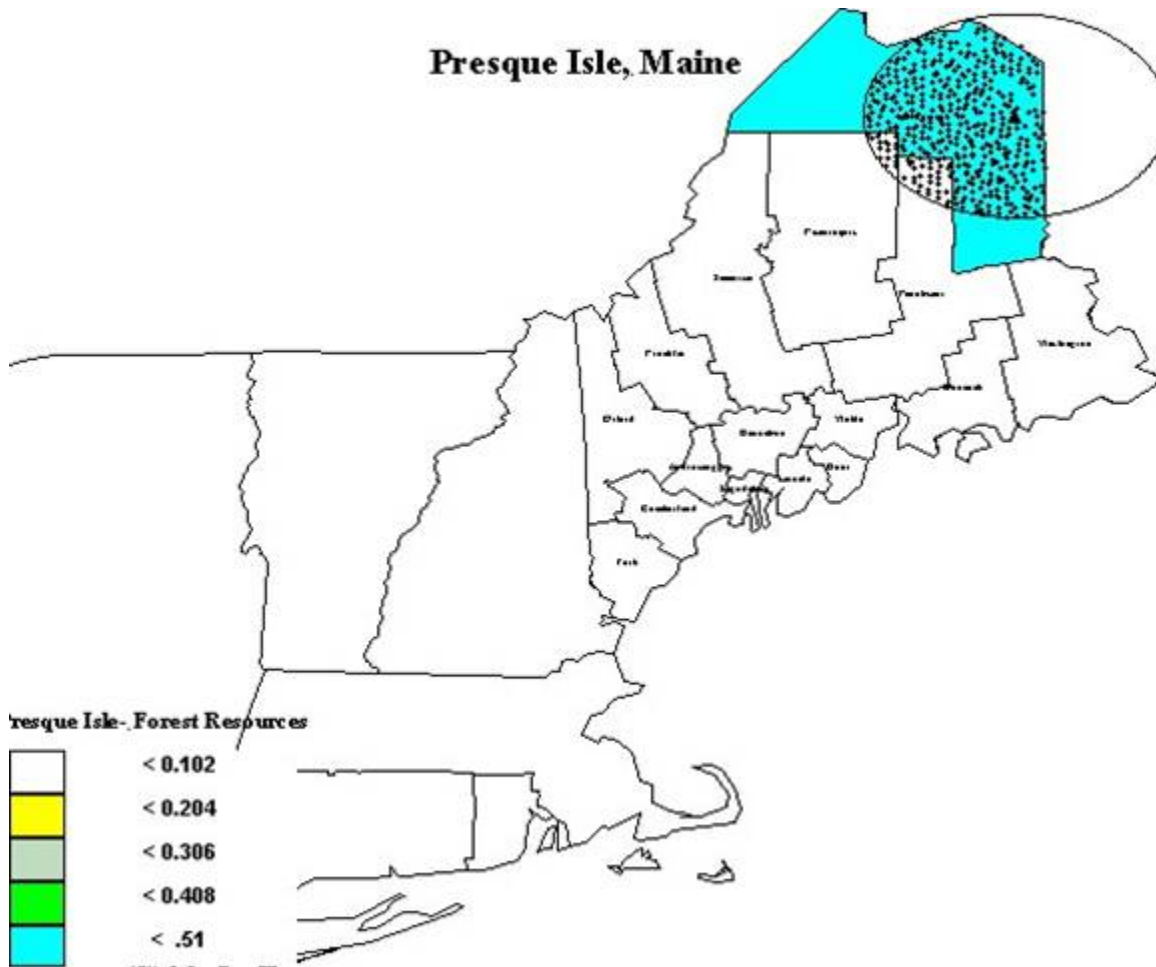


Area of forestland(acres) divided by the total area of land in each County code( acres)<sup>21</sup>

<sup>21</sup> <http://ncrs2.fs.fed.us/4801/fiadb/index.htm> ,USDA Forest Inventory Mapmaker 2.1, 9/29/06.

Presque Isle:

Presque Isle is located in Aroostook County, Maine. 20 miles from Portage the information is the same except for potential sites.



Area of forestland(acres) divided by the total area of land in each County code( acres)<sup>22</sup>

<sup>22</sup> <http://ncrs2.fs.fed.us/4801/fiadb/index.htm> ,USDA Forest Inventory Mapmaker 2.1, 9/29/06.

River Valley:

(Peru) The River Valley is located in Oxford County, Maine. It is made up of ten towns and is an excellent place to locate a biorefinery. Specifically in Peru, one of the ten towns. US Routes 2, 108, and 4 are nearby and rail access is available at several different sites. Pine Tree Zones are present at any location and New Market Tax Credits are also available at site specific locations. Major biomass producers/consumers are NewPage of Rumford, IP and Wausau-Mosinee Paper of Jay. A potential site in Peru could be the former Diamond Match Mill which is already designated a Pine Tree Zone and a New Market Tax Credit Area. Total Acreage: 18, Useable Acreage: 18. 75 Mill St., Peru. Map 29, Lot 18. Site is in the flood zone and has public water and sewage extension. The River Valley population according to the last US Census was 16,592.

Unemployment rates for the River Valley in 2005 were 7.2% and in 2006 they dropped to 4.6% thus far. Employment in the forest based industry in Oxford County can be seen in the chart below:<sup>23</sup>

Year	Employment	Turnover Rate
2001	326	13.5%
2002	297	14%
2003	310	14.7%
2004	281	14%
2005	309	N/A

Oxford County has a fairly large amount of hardwood logging residue at 73,000 tons/year and 67,000 tons/year of softwood logging residue.<sup>24</sup>

Waste in the River Valley Area can be disposed of at the Northern Oxford Regional Solid Waste & Recycling Center in Mexico. Fees are based on per ton waste. Flat fee per ton, would not give specific amount. This facility is a transfer station and sends its solid waste to Waste Management Disposal Services of Maine, Inc. located in Norridgewok. Special waste will not be accepted at the Mexico Transfer Station, only municipal solid waste. NewPage also has a waste facility on Farrington Mountain in Mexico with a 3,960,000 CY capacity. At this time it is only licensed for NewPage waste disposal. It is possible for another entity to use the facility but it would be difficult and re-licensing would be required. The contact for this facility is Mike Sinclair 369-2302.

Waste Management Co. in Norridgewok is a secured line landfill that can accept special wastes. The average rate per ton is \$55-65, yet rates vary depending on transportation distance and fees associated with the distance the waste is transported. Special Wastes that are accepted are:

<sup>23</sup> <http://www.maine.gov>, Maine's LED Data, September 15, 2006.

<sup>24</sup> [http://www.mainefdc.org/pdf/full\\_report.pdf](http://www.mainefdc.org/pdf/full_report.pdf), Robert J. Evans & Doris M. McCormick, *River Valley Biomass Refinery Study*, January 25, 2006, 37 & 38

- Industrial waste is required by Maine DEP to be placed within a secure lined landfill
- Municipal trash to energy incinerator ash
- Waste water treatment plant sludge
- Contaminated Soils
- Asbestos

In order to dispose of special waste with this company, the waste must first be tested and approved. Once approval is gained, waste containers will be provided by the company and drop off can be arranged. It would seem as though Waste Management Co. in Norridgewok would be the most feasible place to dispose of special wastes and the Transfer Station in Mexico for MSW. Norridgewok is roughly 50 miles from Rumford located just before Skowhegan past Farmington. US Route 2 East can be taken the entire distance. This road is not posted normally. The amount of extra traffic on the roads would depend on how much waste is generated. Weight limits can be found in the beginning of this research, limits apply to the transportation of waste as well.

*Pine Tree Zones in the River Valley:*

- Peru
  - Winderosa: Total Acreage: 10, Useable Acreage: 10. 783 Auburn Rd., Peru. Map 13, Lot 26. Site has public water and sewage.
  - Diamond Match: Total Acreage: 18, Useable Acreage: 18. 75 Mill St., Peru. Map 29, Lot 18. Site is in the flood zone and has public water and sewage extension.
- Mexico
  - Total Acreage: 460, Useable Acreage: 369
  - Map 1, Lot 18: Archie's, Inc.- 74.57 acres
  - Map 1, Lot 18-1: William Gates- 1.57 acres
  - Map 1, Lot 15: Enrico Naples- 126 acres
  - Map 1, Lot 14: Mark Ross- 20 acres
  - Map 1, Lot 12: Joseph Bordeau- 75 acres
  - Map 1, Lot 11: Randolph Richards- 69 acres
  - Map 11, Lot 1: NORSWB- 9.24 acres
  - Map 11, Lot 2: Archie's, Inc.- 12 acres
  - Map 11, Lot 3: Dexter Supply- 1.0 acres
  - Map 11, Lot 4: Archie's, Inc.- 75 acres
  - Map 11, Lot 7: Archie's, Inc.- 0.16 acres
  - Map 11, Lot 8: DeRouche- .018 acres
  - Map 12, Lot 1: Archie's, Inc.- 1.68 acres
  - Map 12, Lot 2: Archie's, Inc.- 0.32 acres
  - Map 12, Lot 11: Archie's, Inc.- 4.8 acres
  - Properties are designated as highway commercial, and Route 2 has potential to be developed into an important commercial corridor. Route 2 is serviced by public sewer; water service would need to

- Canton
  - Total Acreage: 145, Useable acreage: 38
  - Water and sewage extension required, Town willing to negotiate the cost of extending services with an eligible PTZ business
  - Canton has no zoning laws but through land use ordinances the submitted parcels are located within the boundaries of the town, within the comprehensive plan designated growth areas and are suitable for PTZ commercial development
- Rumford
  - Total Acreage: 281, Usable Acreage: 217
  - Industrial Park: All sites are served by public sewer and other utilities

Please refer to maps for more detailed locations. (*AVCOG Pine Tree Zones*)

Sites in Rumford, Peru, and Mexico fall under Pine Tree Zones and NMTC areas. All three sites have sewer and water with the exception of a portion of the Mexico site, as listed above.

Roads posted as of 3/30/06 until 6/15/06 in the River Valley Area are as follows:

- Maine 17 ( from after Route 4 to MP 16.860) Gross weight limit in effect No vehicles over 23000 lbs (Mexico, Roxbury, Byron- weight limit does not apply to permitted vehicles when roads are frozen solid)
- Maine 17 (from State Route 4 to US 2) Gross weight limit in effect, no vehicles over 23000 lbs (Oqoussic to Byron- weight limit does not apply to permitted vehicles when roads are frozen solid)
- All local roads are posted each winter-spring with a removal of the posting around May 1<sup>st</sup>. State owned roads are not posted at this time (Rt2, 108, Canton Point Road, etc.) Contacted all ten towns in the River Valley.

Overall, transportation on the level of what a biorefinery in the River Valley would require would not make a significant impact on travel through the region. To transport 750 tons per day of material, a mere 15 more tractor trailer trucks would drive out of the area. As far as rail travel, 3 extra tank cars a day would be in operation to conduct the level of production specified. For intermodal transport, fees are based on type of cargo and destination. If there are 15 more tractor trailer trucks on the road, than there would be 15 or less intermodal cars in operation per day. As long as the proper licenses for



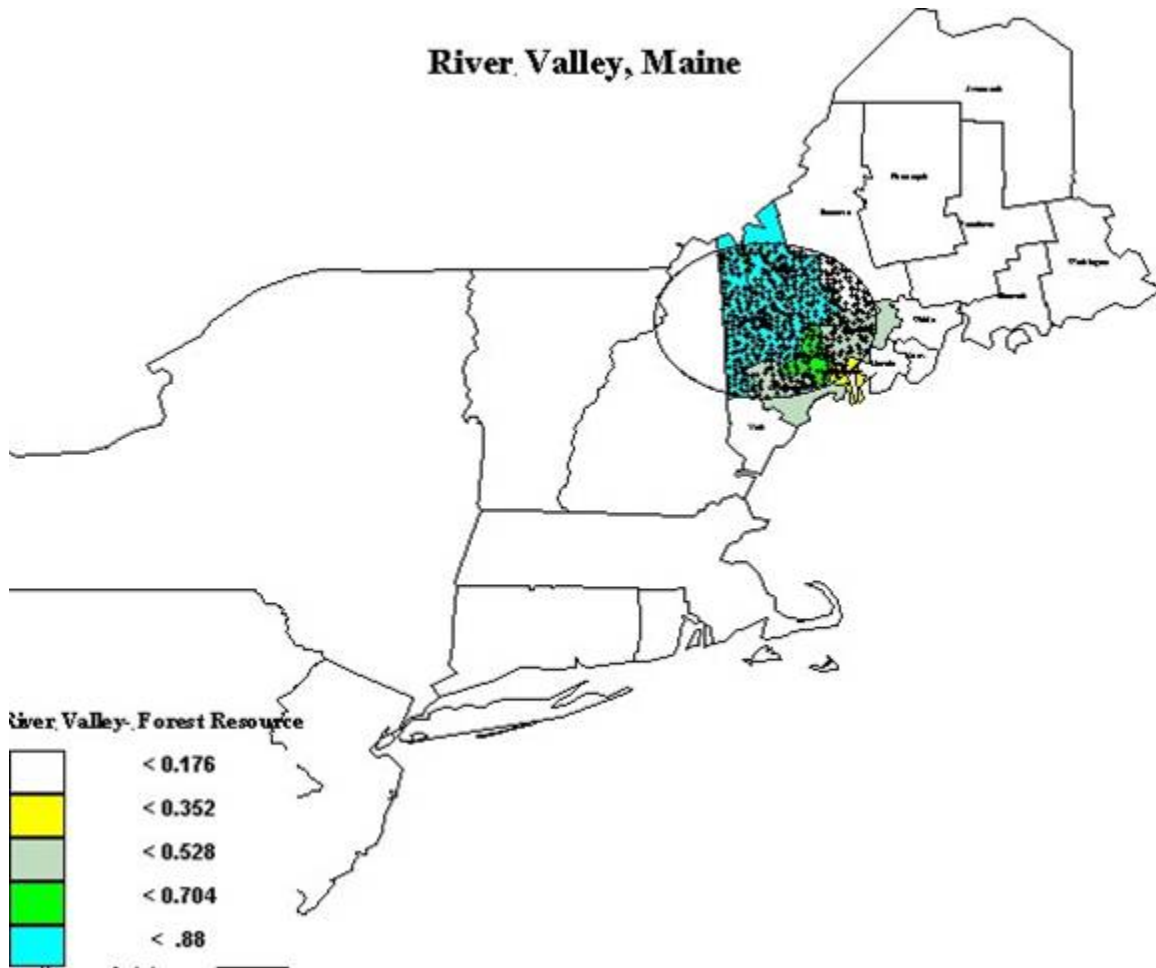
transportation of hazardous or flammable material are obtained through the Maine DOT, there should be no complications.

Unemployment Rates in the River Valley:

- 2003:
  - Jan.: 730/ 10,930, 6.7%
  - Feb: 720/ 10,780, 6.7%
  - March: 700/ 10,750, 6.5%
  - April: 790/9,880, 8.0%
  - May: 750/ 9,570, 7.8%
  - June: 820/ 9,860, 8.3%
  - July: 800/ 9,830, 8.1%
  - Aug: 740/ 9,800, 7.5%
  - Sept: 690/ 9,640, 7.1%
  - Oct: 690/ 9,740, 7.1%
  - Nov: 730/ 9,730, 7.5%
  - Dec: 700/ 10,350, 6.7%
  - Average: 740/ 10,070 or 7.3%
  - Oxford County Average: 1630/ 28,110 or 5.8%
  - Statewide: 34,700/ 695,100 or 5.0%
- 2004:
  - Jan: 730/ 10,850, 6.7%
  - Feb: 700/ 10,830, 6.5%
  - March: 710/ 10,790, 6.5%
  - April: 740/ 10,070, 7.4%
  - May: 680/ 9,710, 7.0%
  - June: 690/ 9,910, 7.0%
  - July: 720/ 9,790, 7.3%
  - Aug: 640/ 9,740, 6.6%
  - Sep: 610/ 9,600, 6.4%
  - Oct: 630/ 9,690, 6.5%
  - Nov: 700/ 9,820, 7.2%
  - Dec: 690/ 10,360, 6.6%
  - Average for 2004: 690/ 10,100 or 6.8%.
  - Oxford County Average- 1580/28,290 or 5.6%
  - Statewide Average- 32,300/ 699,500 or 4.6%
- 2005:
  - Jan: 720/ 10,920, 6.6%
  - Feb: 730/ 10,840, 6.7%
  - March: 690/ 10,810, 6.4%
  - April: 810/ 10,170, 7.9%
  - May: 800/ 9,860, 8.2%

- June: 800/ 10,060, 8.0%
  - July: 770/ 10,100, 7.6%
  - Aug: 700/ 10,040, 7.0%
  - Sept: 690/ 9,890, 7.0%
  - Oct: 680/ 9,950, 6.8%
  - Nov: 770/ 10,070, 7.6%
  - Dec: 760, 10,610, 7.1%
  - Average: 740/ 10,280 or 7.2%
  - Oxford County Average- 1640/ 28,800 or 5.7%
  - Statewide Average- 34,500/ 711,900 or 4.8%
- 2006:
- Jan: 740/ 11,210 or 6.6%, 4.5% statewide (*Maine Department of Labor*)
  - Feb: 4.6% Statewide

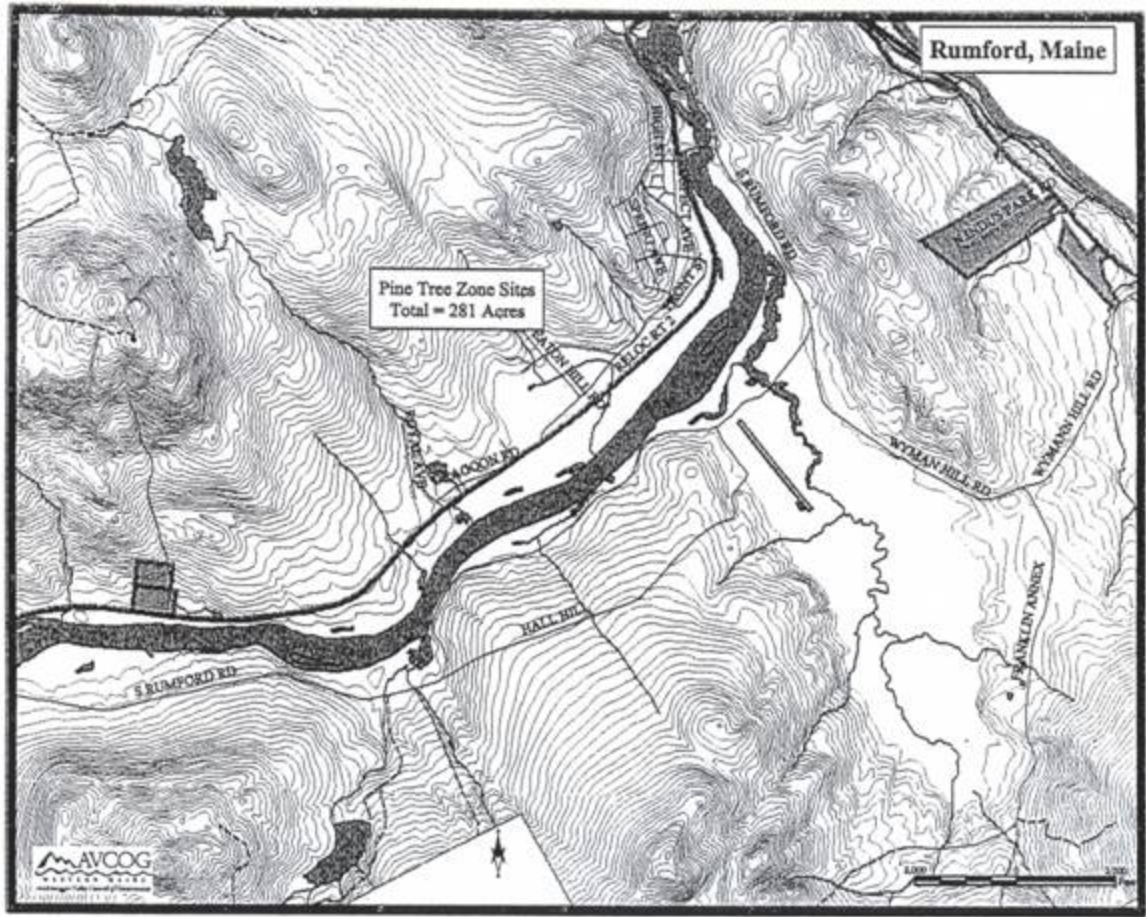
Since 2003, unemployment rates in the River Valley and throughout the entire State of Maine have been steadily rising. The River Valley's unemployment rate can most likely be correlated with the lack of employment opportunities in the region. The introduction of a biorefinery would create employment opportunities and thus help to alleviate this unemployment rate.



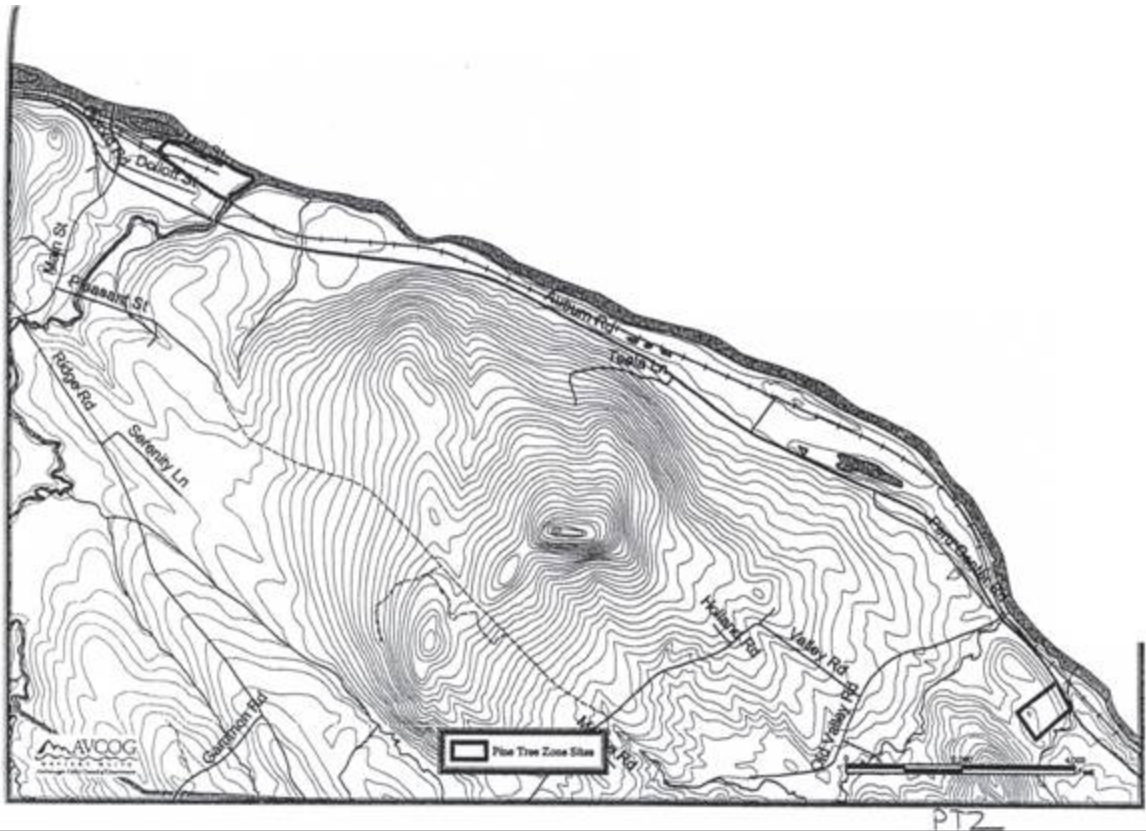
Area of forestland (acres) divided by the total area of land in each County code( acres).<sup>25</sup>

The current drain on biomass in the River Valley area is roughly 2,000-4,000 tons per day by NewPage Corporation in Rumford. This is a moderate amount of drain for the significant amount of forested area within a 50 mile radius, as seen in the map above.

<sup>25</sup> <http://ncrs2.fs.fed.us/4801/fiadb/index.htm> ,USDA Forest Inventory Mapmaker 2.1, 9/29/06.



Rumford, Maine- Pine Tree Zones



Peru, Maine- Pine Tree Zones

1	Auburn	1. Airport	841	577	Industrial	Androscoggin/ Lewiston-Auburn	5.40%	\$541
		1a. Exit 12	182	108	Industrial			
		Downtown	4	4	General Business			
2	Greene	Spragues Mill Road	365	320	NA	Androscoggin/ Lewiston-Auburn	5.40%	\$541
		Rte 202	70	70	NA			
3	Lewiston	1. South Lewiston/Exit 13	650	485	Industrial	Androscoggin/ Lewiston-Auburn	5.40%	\$541
		1a. Fairgrounds Business Park	47	32	Community Business			
		1b. Enterprise Community (pre-determined)	568	315	General Business			
4	Lisbon	Knight -Celotex	23	22	CI	Androscoggin/ Lewiston-Auburn	5.40%	\$541
		Lisbon Center Rt 196	173	140	DDD			
		Capital Avenue	8	8	CI			
		Rt 196/Lewiston-Lisbon townline	128	128	CI			
5	Oxford	Rt 26 & Robinson Mill	333	234	NA	Oxford/Norway-Paris	5.40%	\$541
6	Norway	Technology Park	189	98	NA	Oxford/Norway-Paris	5.40%	\$541
		CB Cummings New Balance Sites East of Village						
7	Paris	Sites on Rt 26 North of Village	144	84	NA	Oxford/Norway-Paris	5.40%	\$541
8	Waterford	Sanborn Machine Property	23	10	NA	Oxford/Norway-Paris	5.40%	\$541
9	Peru	Winderosa	10	10	NA	Oxford/Rumford	5.40%	\$541
		Diamond Match	18	18	NA			
10	Mexico	Rt 2 S.E. corner of town, Rt 2 East of Village	420	369	NA	Oxford/Rumford	5.40%	\$541
11	Canton	Warneright Farm	145	38	NA	Oxford/Rumford	5.40%	\$541
12	Rumford	Rt 2 West of Downtown	281	217	NA	Oxford/Rumford	5.40%	\$541
		Rt 108 South of Downtown						
13	Kingfield	HQ Winters	41	20	NA	Franklin/Farmington	5.40%	\$541
14	Jay	Jay Plaza	144	144	NA	Franklin/Farmington	5.40%	\$541
		G H Bass Route 17 N. Jay	11	11				
		Franklin Memorial Hospital	33	33	NA			
15	Wilton	Franklin Memorial Hospital	11	11	NA	Franklin/Farmington	5.40%	\$541
		Bess-Wilson	1	1	NA			
		Altista	20	20	NA			
		Nichols-Bess Business & Technology Center	39	39	NA			
16	Farmington	High Street	6	6	NA	Franklin/Farmington	5.40%	\$541
		Rt 2 & 4/Franklin Printing	7	2	NA			
			4955	3554				

Pine Tree Zone Information- Androscoggin Valley

			Tech Park: \$2.4 M EDA grant application in progress 5 towns have signed intermunicipal tax sharing agreement \$200,000 received from 6 area towns for preliminary work
	Paris	Rt 25	Curb cuts and Private Water/Sewer hookups
	Waterford	Sanborn Machine Property	Upgrade electrical services, roadway and parking
			Unknown
		Diamond Match	Public Water/sewer extension
		Windsor	
			Water Extension/ Estimated cost \$500,000
12	Canton		Town actively pursuing funding for water expansion Town willing to negotiate the cost of extending services with an eligible PTZ business
			Water and Sewer Extension Required
13	Rumford	Industrial Park	Construct 4,350 sq. ft. road, install sewer line \$500,000 Extend water line \$200,000 Clear 4 acres on 19 lots \$50,000 Three Phase Power \$50,000 Potential Spec Building developers \$1,125,000 Town has permitted and purchased the land for industrial park \$200,000 Town will be spending approximately \$2,000,000 to develop the industrial park
14	Kingfield	HQ Winters	Unknown Willing to consider TIF and COBG requests
			Further extension of water, sewer, and three-phase power may be needed beyond road frontage. Permanent right-of-way through railroad bed owned by DOC is needed and can only be obtained through legislation.
15	Jay	Jay Plaza	Willing to consider TIF and COBG requests
		Road 17	Unknown Willing to consider TIF and COBG requests
		Franklin Memorial Hospital	Further extension of water, sewer, and three-phase power may be needed beyond road frontage. Telecommunications infrastructure in the form of T1 Lines and/or DSL may be required. Willing to consider TIF and COBG requests

**Pine Tree Zone Information- Androscoggin Valley**

Skowhegan:

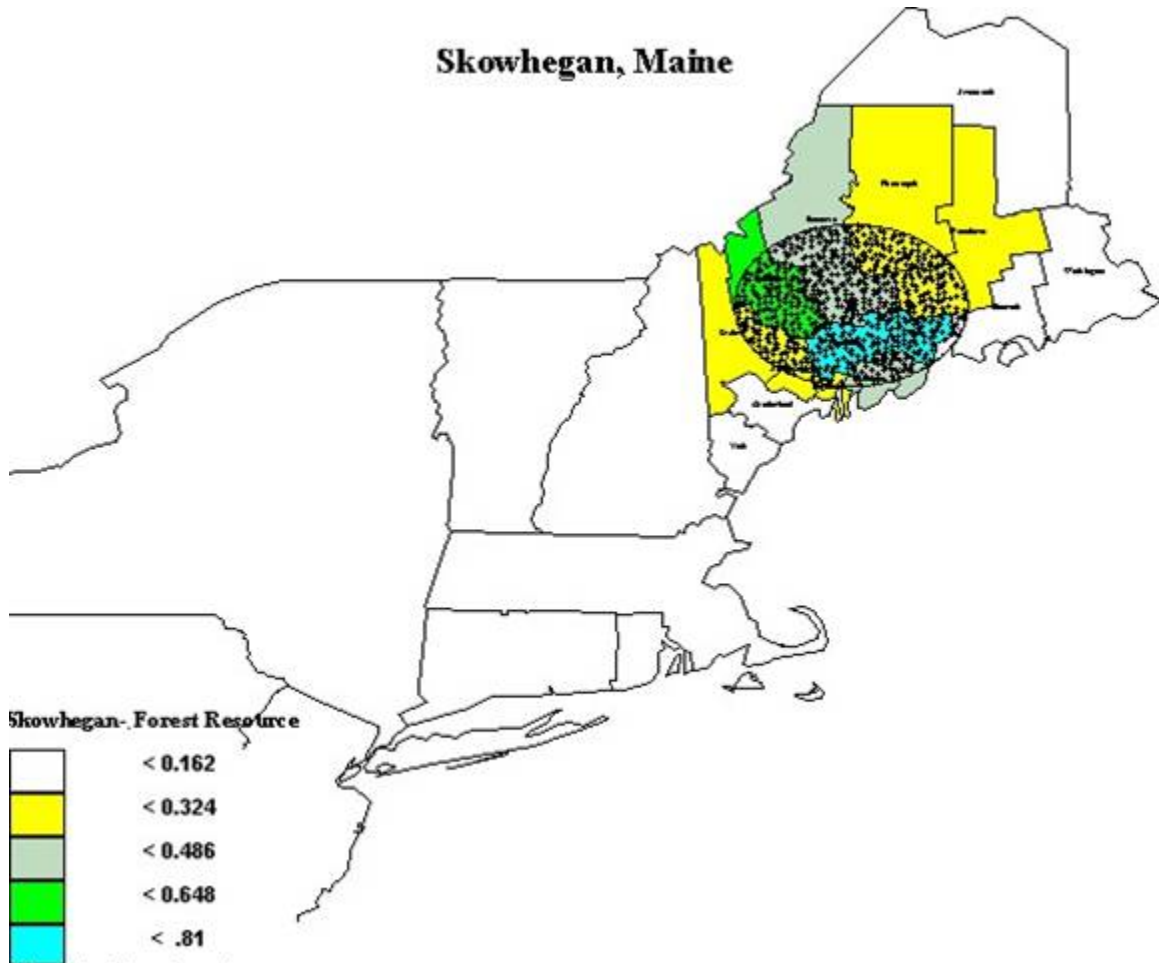
Skowhegan is located in Somerset County, Maine. It has US 201 and 2 running through the community. Major biomass producers/consumers are SAPPI, Madison Paper, and Plum Creek in the area. The Potential site under consideration is the South Gate Industrial Park in Skowhegan. There is water, power, sewer, non-posted roads into the park, and sites sectioned in to 2-12 acres each. Rail access is 1 ½ miles from the park at SAPPI. Skowhegan is very interested in biomass related projects and are willing to be flexible and work with investors to make any project work. Skowhegan’s population according to the last US Census was 10,495.

The unemployment rate in Somerset County in 2005 was 7.6% and in 2006 thus far it is 8.3%. A large spike in unemployment can mean more worker availability. Skowhegan’s unemployment in 2005 was 5% and in 2006 it is 8.8%. With such a high unemployment rate there is definite worker availability. Somerset County’s forest based employment history can be seen in the chart below:<sup>26</sup>

Year	Employment	Turnover Rate
2001	544	12.4%
2002	545	14.7%
2003	517	11.4%
2004	506	11.9%
2005	530	N/A

<sup>26</sup> <http://www.maine.gov>, Maine’s LED Data, September 15, 2006.

Somerset County has the largest amount of hardwood logging residue in the state at 162,900tons/year and a large amount of softwood logging residue at 123,000 tons/year.<sup>27</sup>



Area of forestland(acres) divided by the total area of land in each County code( acres).<sup>28</sup>

<sup>27</sup> [http://www.mainefdc.org/pdf/full\\_report.pdf](http://www.mainefdc.org/pdf/full_report.pdf), Robert J. Evans & Doris M. McCormick, *River Valley Biomass Refinery Study*, January 25, 2006, 37 & 38

<sup>28</sup> <http://ncrs2.fs.fed.us/4801/fiadb/index.htm> ,USDA Forest Inventory Mapmaker 2.1, 9/29/06.

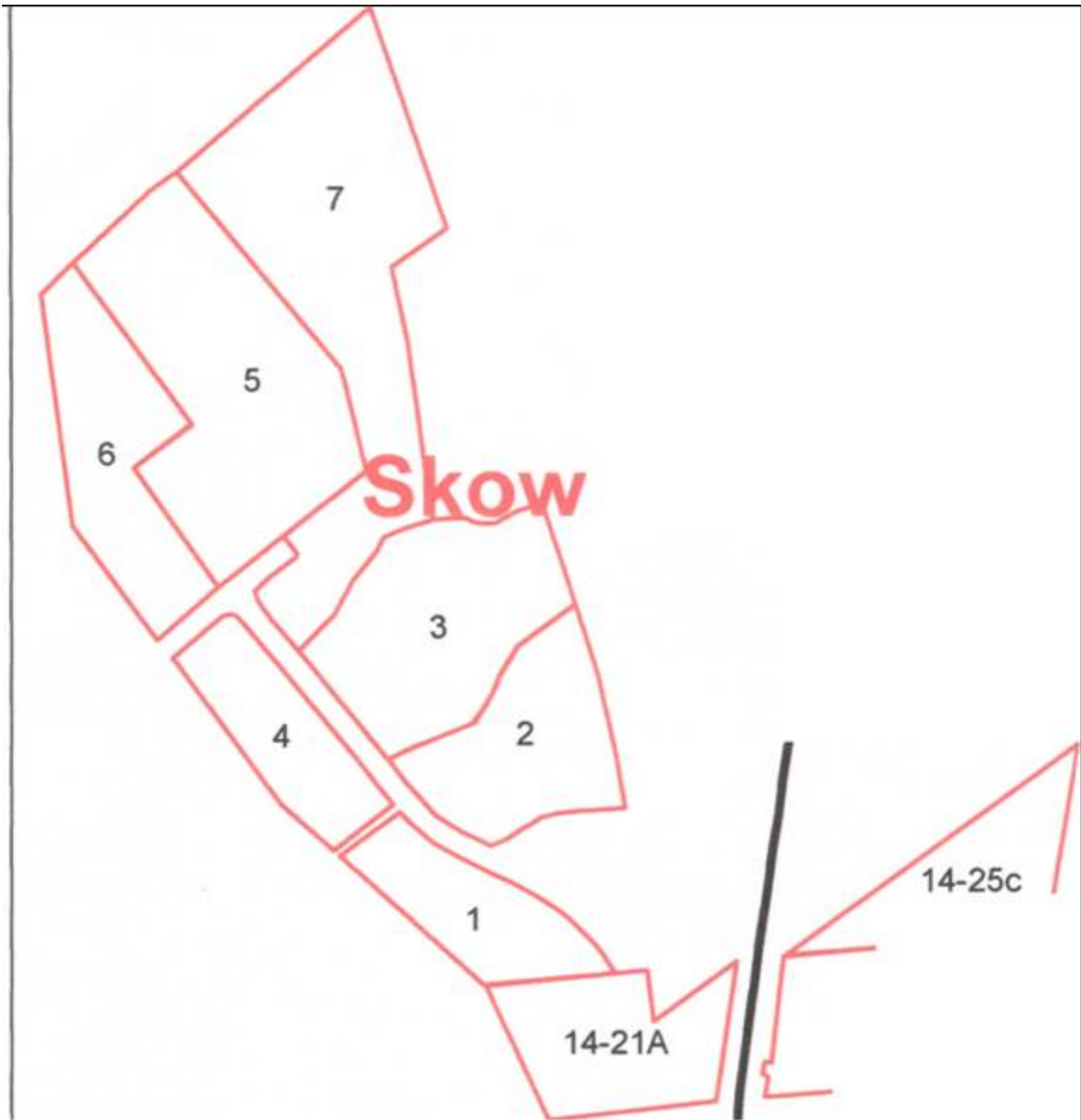


**Southgate Industrial Park- Skowhegan, Maine**





**Aerial of Southgate Industrial Park- Skowhegan, Maine**



Skowhegan, Maine- GIS Property Tax Lines



Skowhegan, Maine- Southgate Industrial Park



**Somerset County, Maine**

Waldoboro:

Waldoboro is located in Lincoln County, Maine. Lincoln County is known as a prominent “wood basket” in Maine. US 1 and I-95 run through the community. Newark Group Inc. is the major biomass producer and is roughly 27 miles away. Two viable Pine Tree Zone locations in Waldoboro: (1) the Osram Sylvania property and (2) George Seaver’s Environmental Business Park. Both properties are located proximate (1 mile or less) to the Maine Eastern (Brunswick-Rockland) freight rail and U.S. Route 1. The Sylvania property consists of a relatively modern, 104,000 (84, 000) square-foot building located on 49 acres (part woodland, part cleared) on Route 220, just south of Route 1. There is unlimited parking and municipal water and sewer, three-phase power and loading docks for businesses fueled by the biorefinery plant. A local citizens’ economic development task force has in fact envisioned an alternative, renewable energy plant as an appropriate reuse strategy for the now defunct coils plant. Mr. Seaver’s 72-plus-acre business park is located on Route 32, just north of Route 1. There is sufficient space to custom build a facility to specification. The Town of Waldoboro provides a “business friendly” climate that would serve as an excellent foundation for building a strong partnership.

Waldoboro has several manufacturers of moderate size and scale, including Masters and Sheepscot Machine shops, large swaths of working forest and farmland, a concentration of maritime and marine related industry, including research facilities, marinas, and boat builders; many small businesses, both seasonal and year-round. While health care and education play a dominant role, Lincoln and adjacent counties concentrate significant entrepreneurial innovation and activity in a rural, pastoral setting. In fact, George Seaver and Norm Golden, of Ocean Organics, producer of seaweed based fertilizer (and supplier to golf courses nationwide), have already undertaken a local effort to produce biofuel.

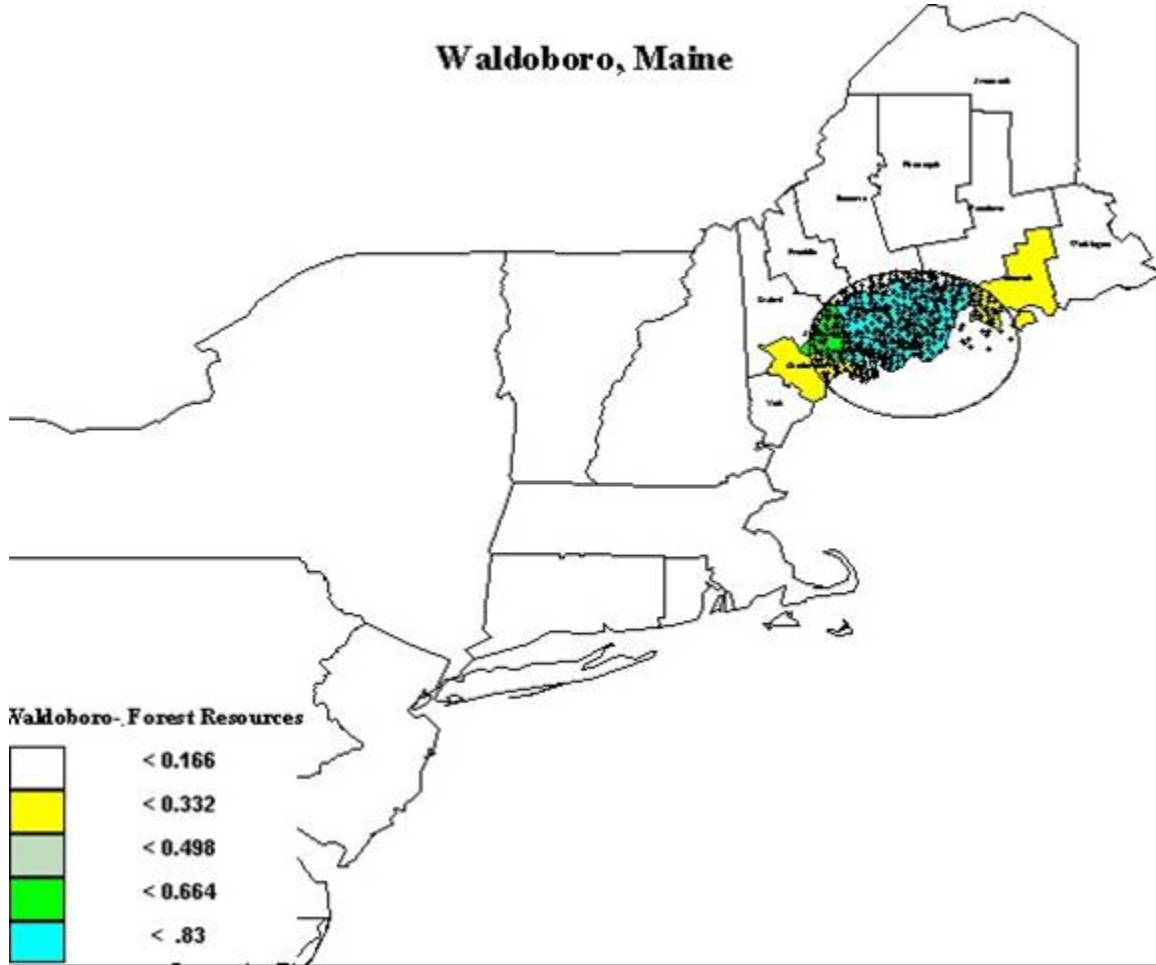
Primarily accessible (and bifurcated) by Route 1, Lincoln County is part of the Midcoast Economic Development District. Construction of a biomass plant would suit the area’s economic development goals and interests. In addition to these Waldoboro locations, there are locations in Pine Tree Zones in Boothbay and Wiscasset, and in North Waldoboro that merit consideration. Waldoboro’s population according to the last US Census was 5,929.

Lincoln County unemployment rates in 2005 were 4.3% and in 2006 thus far are 4.95%. Waldoboro unemployment rates in 2005 were 2.5% and in 2006 4.5%. A considerable increase would mean higher worker availability.

Lincoln County has a softwood logging residue rate of 16,000 tons/year and a hardwood logging residue rate of 5,800 tons/year. Somewhat smaller than other counties, size consideration of the county must be taken into consideration. A large percentage of the logging and forested areas are located in Waldoboro for the entire county.

Lincoln County forest based employment information can be seen in the chart below:<sup>29</sup>

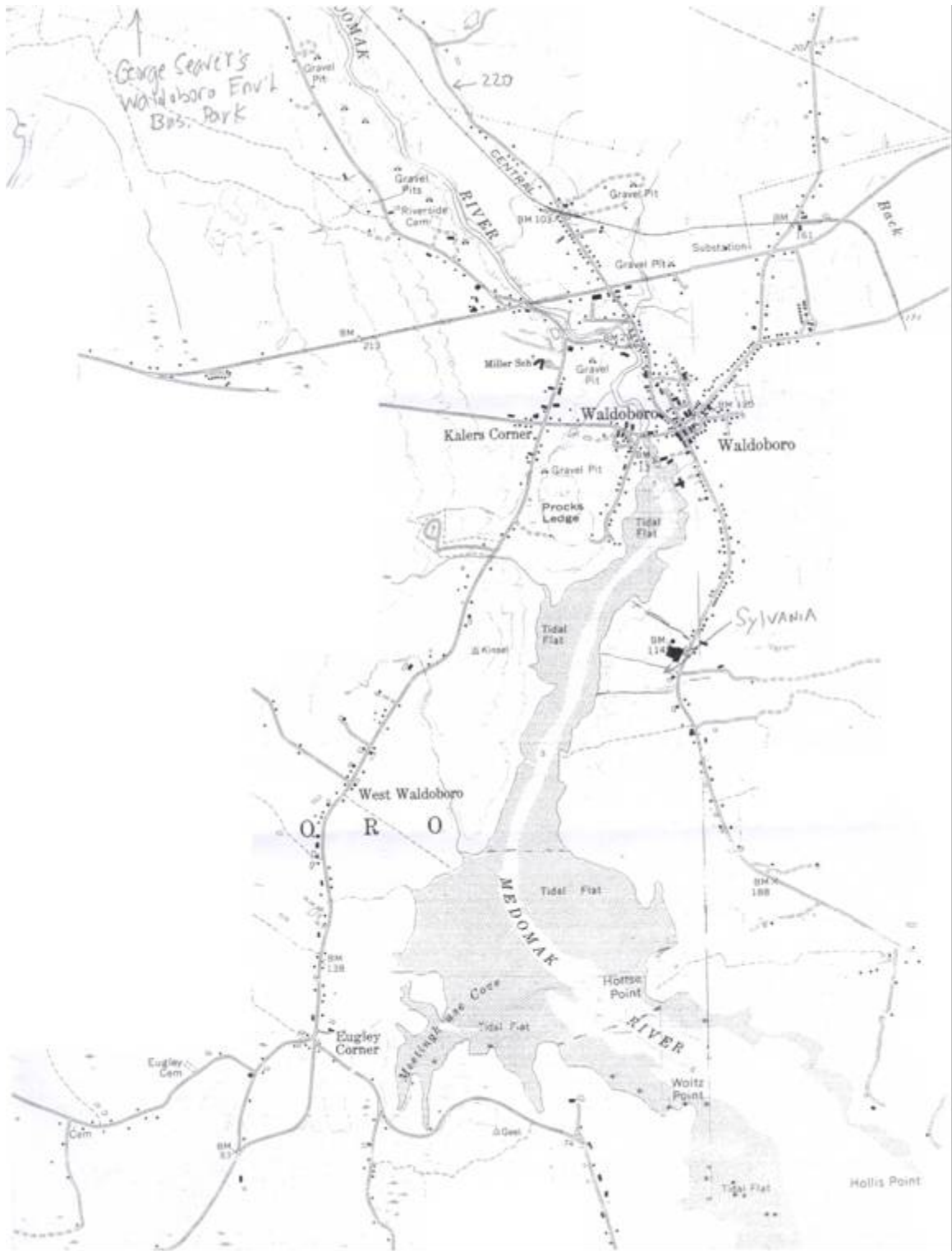
Year	Employment	Turnover Rate
2001	78	17.3%
2002	81	18.9%
2003	89	21.3%
2004	93	19.5%
2005	98	N/A



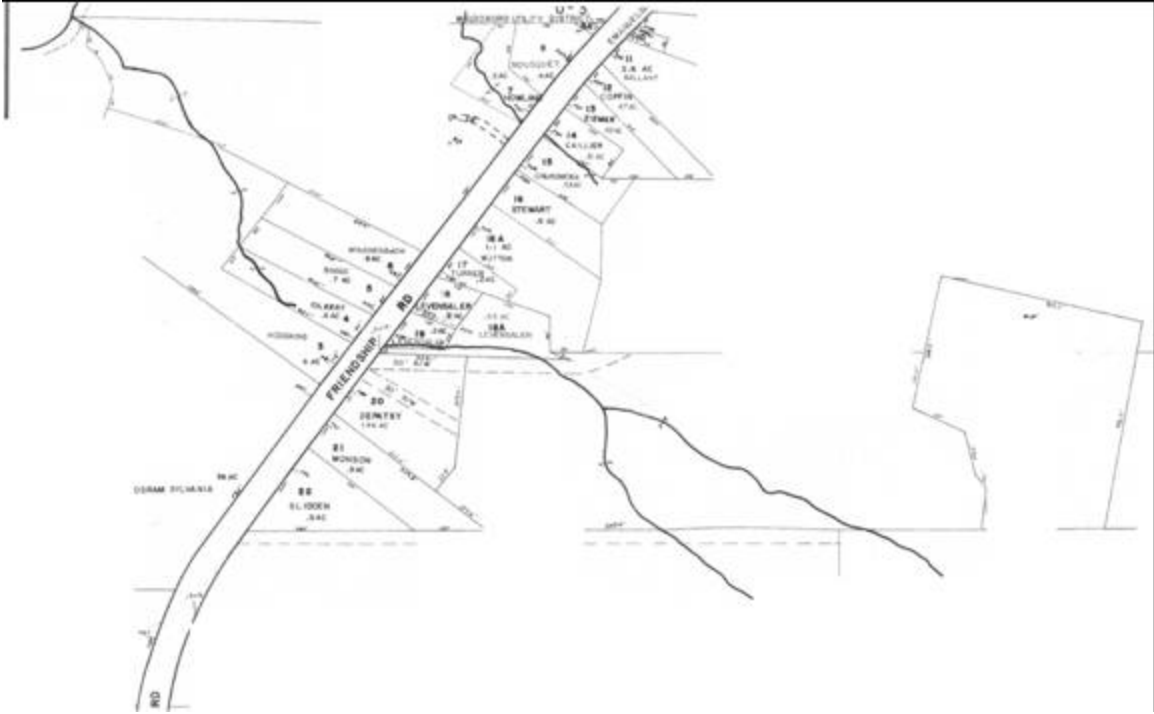
Area of forestland(acres) divided by the total area of land in each County code( acres).<sup>30</sup>

<sup>29</sup> <http://www.maine.gov>, Maine's LED Data, September 15, 2006.

<sup>30</sup> <http://ncrs2.fs.fed.us/4801/fiadb/index.htm>, USDA Forest Inventory Mapmaker 2.1, 9/29/06.

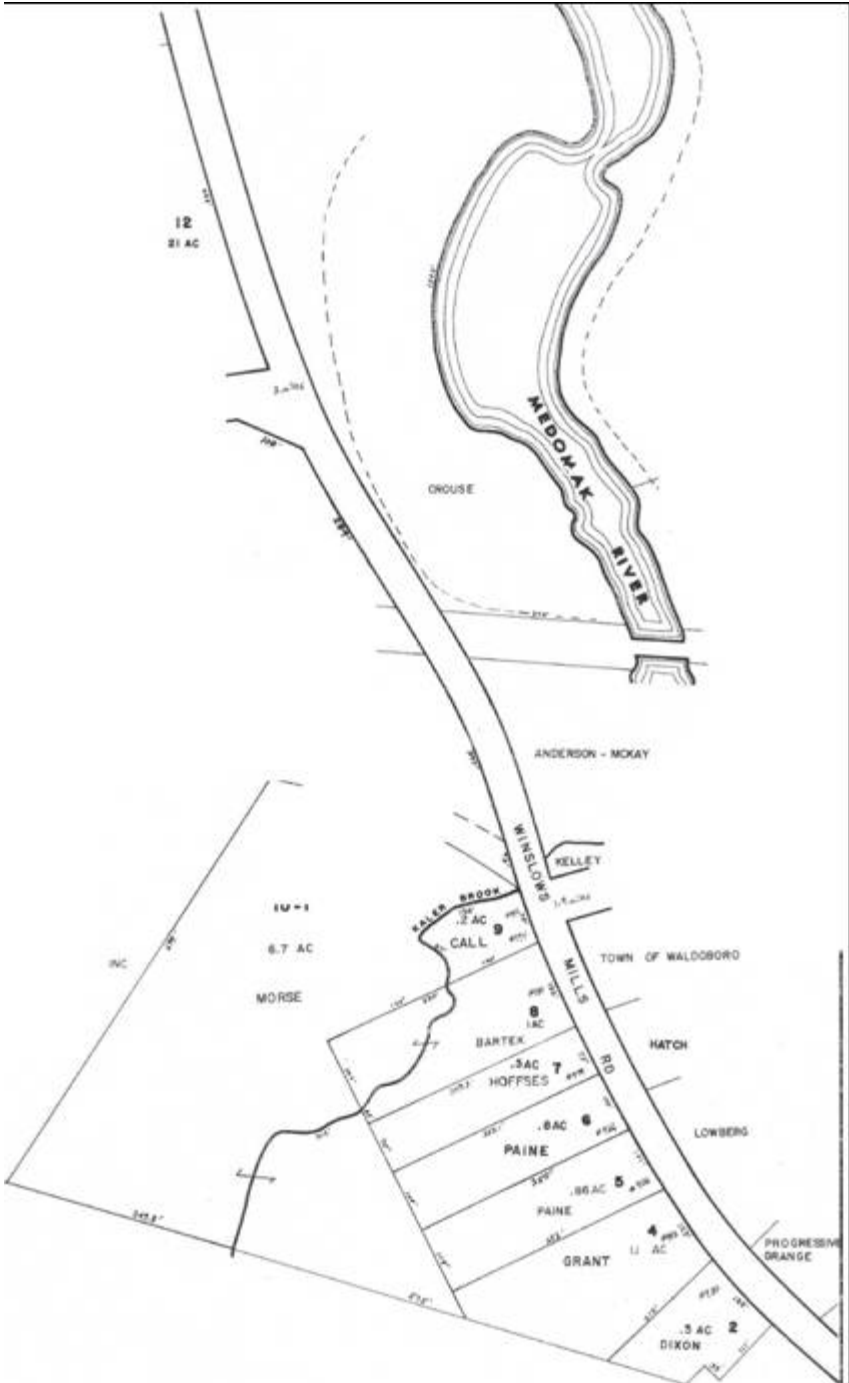


Waldoboro, Maine- George Seaver's Environmental Business Park



Waldoboro, Maine





Waldoboro, Maine- Property Tax Map

Westbrook:

Westbrook is located in Cumberland County, Maine. It is a major city in the State and has I-95, US 302, 202, 4, and 1 running through and nearby the community. The potential site is the former SAPPI mill location. This location has power, sewer, water, steam heat capability, wastewater treatment facility on site, and designated Pine Tree Zones. Westbrook is a city that supports new manufacturing and industrial projects. With the closing of the SAPPI mill there are many skilled workers available in the city and surrounding areas. Rail access is available on site and both major pipelines in Maine run through the community.

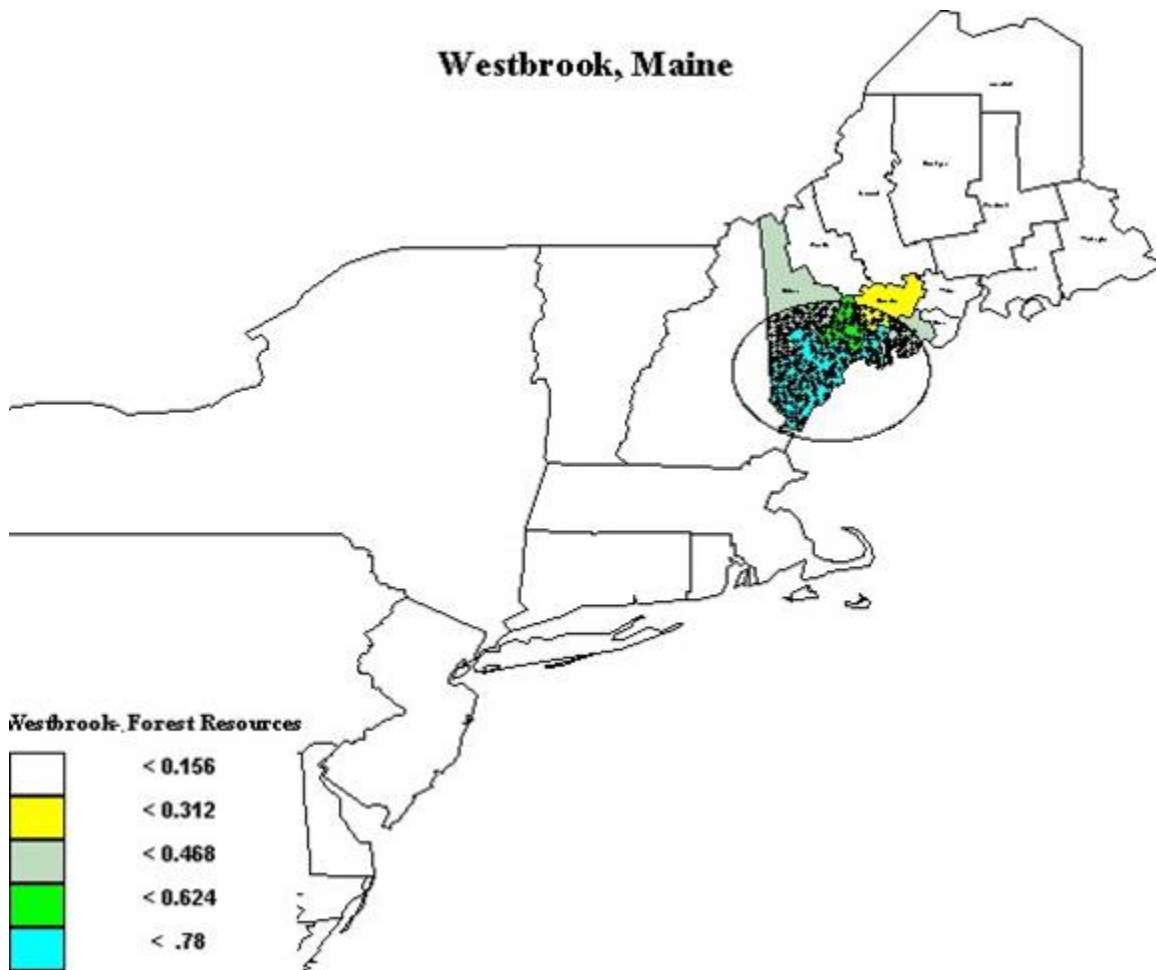
Cumberland County's unemployment rate in 2005 was 3.6% and thus far in 2006 it is 3.5%. The forest based employment in Cumberland County can be seen in the chart below:<sup>31</sup>

Year	Employment	Turnover Rate
2001	268	15.7%
2002	284	15.5%
2003	253	15.4%
2004	273	15.2%
2005	265	N/A

Cumberland County's hardwood logging residue is 25,300 tons/year and softwood logging residue is 25,000 tons/year.

---

<sup>31</sup> <http://www.maine.gov>, Maine's LED Data, September 15, 2006.



Area of forestland(acres) divided by the total area of land in each County code( acres)<sup>32</sup>

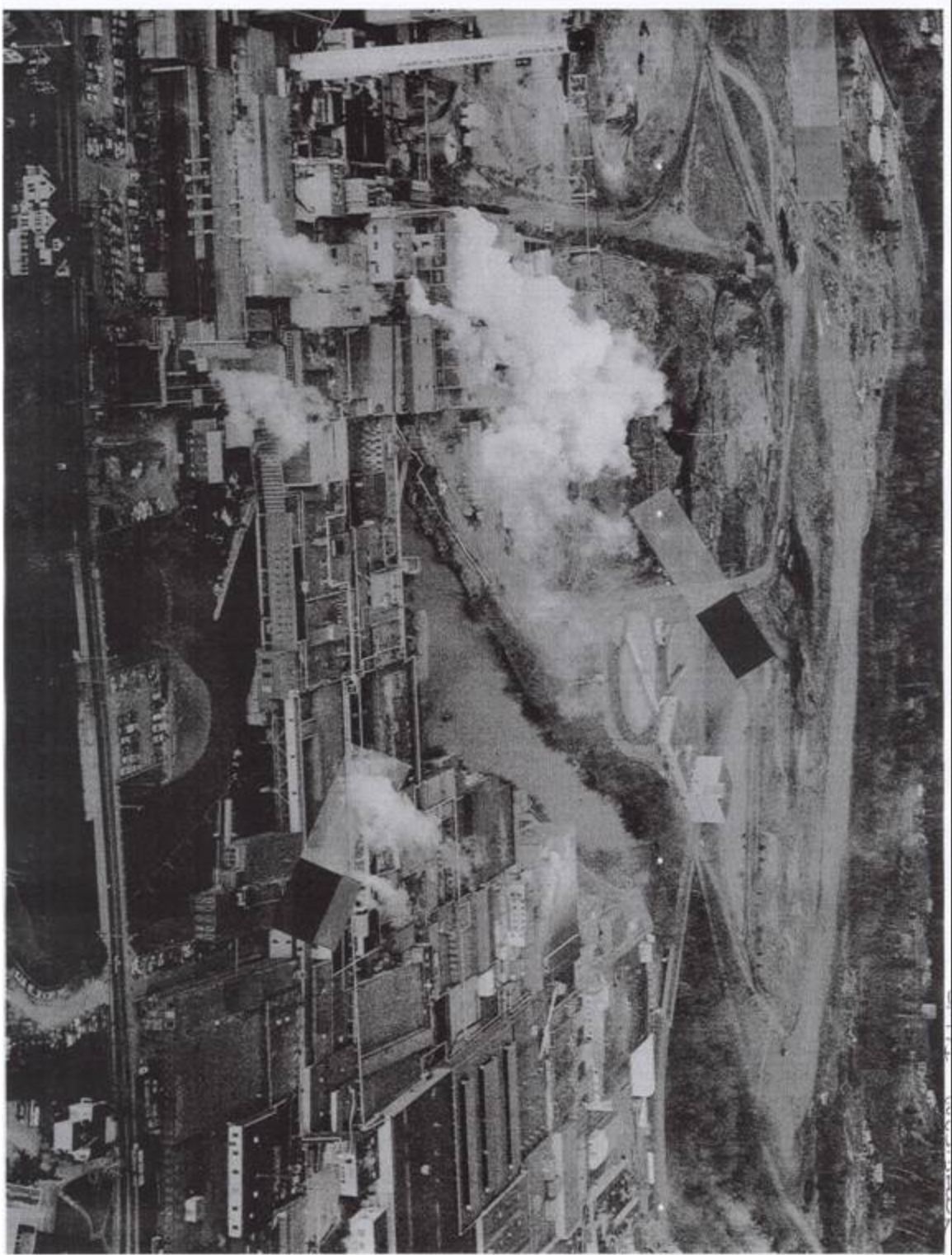
<sup>32</sup> <http://ncrs2.fs.fed.us/4801/fiadb/index.htm> ,USDA Forest Inventory Mapmaker 2.1, 9/29/06.



Westbrook, Maine- SAPPI Paper Site



Westbrook, Maine- Property Tax Map



Westbrook, Maine: SAPPI Site



## **MicroChem Technologies Inc.**

**8999 W. Harvard Place  
Lakewood, CO 80227-6106**

**Phone: 720-352-9425  
Fax: 303-988-0029**

# **River Valley Biomass Refinery Market Study**

**Final Report**

**Submitted to the Fractionation Development Center**

**Draft**

**Robert J. Evans and Doris M. McCormick**

**January 25, 2006**

### **Contact Information**

**Robert J. Evans  
Senior Scientist  
MicroChem Technologies Inc.  
8999 W. Harvard Pl.  
Lakewood CO 80227  
Phone: 720-352-9590  
Email: [bevans@mchemtech.com](mailto:bevans@mchemtech.com)**

This report was prepared with the support of the U.S. Department of Energy, under Award No. DE-FG36-04GO14246. However, any opinions, findings, conclusions, or recommendations expressed herein are those of the authors and do not necessarily reflect the views of the DOE.

## Table of Contents

	<b>Summary</b>	<b>8</b>
	• Feedstocks	8
	• Conversion Technology	11
	• Pyrolysis	12
	• Gasification	12
	• Fractionation	14
	• Market Analysis	14
	• Test Case Description	17
<b>1.0</b>	<b>Compilation of Feedstock Supply Data and Characteristics</b>	<b>24</b>
1.1	Maine's Position in the North American Forest Product Industry	25
1.1.1	Employment	25
1.1.2	The Industrial Investment in Maine's Forest Product Industry	29
1.2	Feedstock Supply	32
1.3	Species Distribution	36
1.3.1	Hardwood Residue Distribution	37
1.3.2	Softwood Residue Distribution	38
1.4	Chemical Characteristics and Relation to New Uses	39
1.5	Paper Mill Residues	42
1.5.1	Tall Oil	42
1.5.2	Sludge	42
1.5.3	Black Liquor	43
1.5.4	Bark	44
1.6	Municipal Solid Waste	45
1.6.1	Construction and Demolition Wood (CDW)	45
1.6.2	Waste Paper	47
<b>2.0</b>	<b>Assessment of Conversion Technology Options</b>	<b>48</b>
2.1	Pyrolysis	50
2.1.1	Bio-Oil Separation	51
2.1.2	Bio-Oil Reforming	52
2.1.3	Acetalization	53
2.1.4	Activation	53
2.1.5	Densification	53
2.1.6	Adsorption	54
2.1.7	Case Descriptions	54
2.2	Gasification	59



2.2.1	Syngas Background	59
2.2.2	Gas Conditioning	61
2.2.3	Reforming	61
2.2.4	Ammonia Catalytic Synthesis	63
2.2.5	Fischer Tropsch Catalytic Synthesis	64
2.2.6	Methanol Catalytic Synthesis	68
2.2.7	Mixed Higher Alcohol Catalytic Synthesis	73
2.2.8	Ethanol from Syngas Bioconversion	75
2.2.9	Combustion	76
2.2.10	Case Descriptions	77
2.3	Fractionation	81
<b>3.0</b>	<b>Product Market Status and Trends</b>	<b>85</b>
	Develop a Vertically Integrated Market Focus	85
	Forge a Regional Strategy	85
	Build on Maine's Petroleum Infrastructure	86
	Enter the Petroleum Value Stream	87
	Focus on the Heating Oil Market as the Cornerstone	88
	Evolve into the Market for Green and Natural Products	89
	View Bioenergy Production as a Catalyst for Manufacturing	89
	Understand the Supply and Demand Problems with Electricity	90
	Fill the Natural Gas Vacuum	91
	Understand the Western European Chemical Industry	91
3.1	Bio-Oil	92
3.1.1	Pyrolytic Lignin	95
3.1.1.1	Adhesives	96
3.1.1.2	Oxy-Aromatics	96
3.1.2	Hydrogen	97
3.1.2.1	Refinery Feedstock	98
3.1.3	Fuel Blends	100
3.1.3.1	Bio-Heat	101
3.1.3.2	Diesel	102
3.2	Bio-Carbon	103
3.2.1	Activated Carbon	103
3.2.2	Fuel Pellets	106
3.2.3	Agricultural Chemicals	108

3.3	BioSynGas	109
3.3.1	Power	110
3.3.1.1	Power Parks	111
3.3.2	Thermochemical Ethanol	112
3.3.2.1	The Ethanol Market in the Northeast	112
3.3.3	Hydrogen	114
3.3.4	Dimethyl Ether	115
3.3.5	Fischer Tropsch Liquids	116
3.3.6	Ethylene	117
3.3.7	Propylene	117
3.3.8	Reformulated Gasoline	118
3.4	Cellulose	119
3.4.1	Fiber	119
3.4.2	Levulinic Acid	120
3.4.2.1	Ethyl Levulinate	120
3.4.2.2	Methyltetrahydrofuran	121
3.5	Lignin	121
3.5.1	Oxy-Aromatics	123
3.6	Sugars	123
3.6.1	Xylitol	123
3.6.2	Lactic Acid	123
3.6.3	Propane Diol	123
3.6.4	Ethanol	124
3.6.5	Furfural	124
3.6.5.1	Methylfuran	125
3.7	Extractives and Tall Oil	125
3.7.1	Terpenes	127
3.7.2	Fatty Acids	130
3.7.3	Tannins	131
<b>4.0</b>	<b>Market Penetration</b>	<b>134</b>
4.1	Subjective Estimation of Market Penetration	134
4.2	Potential Market Scenarios	136
4.2.1	Technology	137
4.2.2	Economics	138
4.2.3	Policy	138

### List of Figures

1	Staged Gasification Process Concept	13
2	Conceptual Model for the Market Study	15
3	The Three Stage Parallel and Serial Conversion Pathway	21
4	Illustrative Deployment of Three Stages of Conversion Plants	22
1.1	Overview of the Feedstock Sources and Conversion Targets	24
1.2	Employment in Forest and Paper	26
1.3	Employment Percent of Manufacturing Jobs	27
1.4	Paper Employment Versus Paper Production	27
1.5	Annual Payroll Income Versus. Value of Paper Shipments	28
1.6	Value Versus Volume of Paper	29
1.7	Capital Investment in Paper Manufacturing	31
1.8	Capital Investment in Wood Product Manufacturing	31
1.9	Intensity of Softwood Growing Stock Relative to Timberland Area	32
1.10	Density of Hardwood Growing Stock Relative to Timberland Area	33
1.11	Estimates (1999) of Forest Residues Available	34
1.12	Estimates (1999) of Mill Residues Available	35
1.13	Hardwood Logging Residues by County	37
1.14	Softwood Logging Residues by County	38
1.15	Breakdown of Major Components	39
2.1	Global View of Biomass Conversion Options	48
2.2	Biomass Pyrolysis Conversion Pathways	50
2.3	Typical Fast Pyrolysis System Based on Fluid Bed Technology	51
2.4	Mass and Energy Balances for Case P1	55
2.5	Mass and Energy Balances for Case P2a	56
2.6	Mass and Energy Balances for Case P2b	57
2.7	Biomass Gasification Conversion Pathway and Potential Products	58
2.8	Typical Wet Scrubbing System as Used in the Enerkem Fluid Bed	61
2.9	Generic Fischer Tropsch Process Flow Diagram	65
2.10	Mass and Energy Balances for Case G1a	79
2.11	Mass and Energy Balances for Case G1b and G2	80
2.12	Biomass Fractionation Conversion Pathway and Target Products	82
3.1	Consumption and Price of Crude oil in the United States.	88
3.2	Home Heating Oil Consumption and Cost in Maine	90
3.3	Monthly Cost of Electricity in Maine by Sector	91

3.4	Monthly Sales of Electricity in Maine by Sector	92
3.5	Estimates of Chain Costs for a European Situation	96
3.6	Phenol Market Data	98
3.7	Market and Price Projections for Activated Carbon	105
3.8	Current hydrogen production sources and markets	115
3.9	Conceptual Model of the Structure of a Softwood Lignin	123
3.10	Basic Classes of Terpenes	128
3.11	Monoterpenes Common to Softwoods	129
3.12	Neutral Diterpenes from Softwoods	130
3.13	Acidic Diterpenes (Rosin Acids) from Softwoods	130
3.14	Typical Tannin from Mountain Maple ( <i>Acer spicatum</i> ) Bark	132
3.15	Triterpenes from Birch Bark	133
3.16	Oak Triterenes and Lignans	133
3.17	Phenolic Glycosides from Salicaceae	134
4.1	Market Penetration Curves for the Base Deployment Model	135
4.2	Interaction of the Three Market Drivers	138

#### List of Tables

1	Comparison of Feedstock	9
2	Base Assumptions of Feedstock Availability and Costs	10
3	The River Valley Biorefinery Project by Feedstock Type	11
4	Classification of Topic Areas Covered in Market Study	16
5	First Round Classification of Cases for Market Evaluation	18
6	Weighted Comparative Analysis of Thermochemical Scenarios	20
1.1	Major Forest Products Companies in Maine	30
1.2	Predominant Forest and Species in Maine	36
1.3	Hardwood Logging Residues, ton/year	37
1.4	Softwood Logging Residues, ton/year	38
1.6	Hardwood Composition, % of Wood on Extractive Free Basis	40
1.7	Softwood Composition, % of Wood on Extractive Free Basis	41
1.9	Chemical Characterization of Paper Mill Sludge (%)	43
1.10	The Approximate Composition of Ash Free Wood and Bark, wt %	44
1.11	Typical Bark Volumes as a Function of Species and Age	44
1.12	Municipal Solid Waste Biomass Plants	45

1.13	Maine Solid Waste and Recycling Tonnage, 2003	45
1.14	Allowable Limits for Wood Combustion Plants	46
3.1	Pyrolysis Liquids Properties	93
3.2	IEA Proposed Pyrolysis Oil Specifications	94
3.3	Bio-oil Value by Addition to Home Heating Oil as a 10% Blend	103
3.4	Major Producers of Activated Carbon	106
3.5	National Residential Pellet Fuel Standards	108
3.6	Estimates of Potential Ethanol Market in the Northeast	114
3.7	Extractive Composition of Illustrative Hardwoods and Softwoods	127
3.8	Producers of Tall Oil Derived Chemicals in the United States	128
4.1	Implication of Base Model Assumptions	136
4.2	Maine Energy Use by Sector and Source	137

#### **List of Appendices**

A	Horizon Technologies Inc. Subcontract Report	140
B	Chemical Engineering Consulting Services Subcontract Report	193
C	Reference Databases	229
D	Feedstock Distribution	323

## Summary

This market analysis evaluates options for an expanded bioproducts industry in the River Valley area of Western Maine. This project is sponsored by the River Valley Growth Council (RVGC), whose mission is to stimulate economic growth in the Western Maine region based on sustainable technologies that can utilize the significant forest biomass resource in the area for the expansion and creation of companies that will develop this new suite of products. The vision of the RVGC is to build a complementary economic base to the paper industry by processing underutilized forest feedstocks and residues to produce a suite of products, including fuels, green power, chemicals, and materials that will bring primary manufacturing jobs and improved economic conditions to the area.

### Feedstocks

This report discusses feedstock issues and opportunities by comparing Maine to other pulp and paper states concerning feedstock supply and composition. As in the paper industry, Maine bio-products will compete for investment dollars and market shares with other regions in the United States and the world. The focus of this report is to develop market options that will return the maximum profit to Maine with the minimum risk.

The first issue to consider is the size of the target plant and the relative increase in demand on the feedstock base. **Table 1** shows the increase in the relative amounts of technical and economic feedstock supplies in Maine and specific to the Western region. The total biomass on timberland is 990 million dry tons including the total growing stock timber and residues, such as branches, foliage and unusable trees [1.1(178)]. This is a 13% increase since 1995 [1.0(16)]. The growing stock levels in the state and the western region are approximately 50% of the total biomass. The growing stock values include poletimber, sawtimber, and the upper stem, which is the portion of the tree above the useable saw log length. Only the latter portion is included in the residue number. This 227 mil ton for Maine is not the annual harvest, but rather shows the reservoir of target materials from which an annual harvest can be taken. The ORNL (Oak Ridge National Lab) estimate factors the amount of residue that can be harvested on an annual basis beyond the current use rate. Maine has 1.5 million (MM) dry tons/year, which is small, compared to the estimate of 3.6 MM dry tons/year that is used currently for biopower. This is only 0.15% of the total biomass estimate.

**When looking at the western region we can then apply these same conservative criteria and predict an available residue supply of 250,000 dry tons/year or enough for a 750 dry tons/day facility. In addition to targeting initial processes with conservative feedstock requirements, RVGC can further diminish risks by assuming reasonable feedstock costs that can be**

used to screen target products that can compete with existing products such as power and paper.

**Table 1: Comparison of Feedstock**

Maine	Mil dry t/y	% Theoretical
Existing Biopower <sup>1</sup>	3.6	0.36
ORNL, Forest Residue <\$50/t <sup>2</sup>	1.5	0.15
USDA Residue <sup>3</sup>	227.3	22.96
USDA Growing Stock <sup>4</sup>	464	46.87
USDA Biomass <sup>5</sup>	990	100.00
<b>Western Maine</b>		
Existing Biopower <sup>6</sup>	1.25	0.84
RVGC, Forest Residue <sup>7</sup>	0.25	0.17
USDA Residue <sup>3</sup>	29.6	19.73
USDA Growing Stock <sup>4</sup>	75	50.00
USDA Biomass <sup>5</sup>	150	100.00

1. Includes independent power generators and paper mills, but not MSW, with a total combined capacity of 646 MWe [Energy Efficiency and Renewable Energy, 2005] [2.0(27)] and assumes 5000 BTD/Y/MWe. [Walsh et al, 2003]. [1(126)]
2. [Walsh et al, 2003]. [1(126)]
3. Includes upper stem, branches, foliage, cull trees and dead trees, but not stumps and roots, saplings, and shrubs [Laustsen et al, 2003, Appendix D Table 1] [1.1(178)].
4. Includes pole timber, sawtimber, and upper stem [Laustsen et al, 2003, Appendix D, Table 1] [1.1(178)]
5. Includes growing stock, residue, stumps and roots, saplings and shrubs [Laustsen et al, 2003, Appendix D Table 1] [1.1(178)]
6. Includes International Paper plant in Jay, 80 MWe; MeadWestvaco Paper Mill in Rumford, 85 MWe; Alternative Energy biopower plant in Livermore Falls, 39.6 MWe; and the Boralex biopower plant in Stratton, 45.7 MWe and assumes 5000 BTD/Y/MWe [Energy Efficiency and Renewable Energy, 2005] [2.0(27)]
7. Target level assumed for the first generation biorefinery in western Maine based on conservative feedstock resource estimates for Oxford and Franklin counties.

Table 2 shows a comparison of products for the 250,000 dry tons/year assumptions. Assuming \$40/BDT, the feedstock costs will be \$10 million/year. Using approximations for product value, the hydrogen (DOE target of \$2/kg or gallon of gasoline equivalent) is estimated to be twice the value of power production and the value of levulinic acid (LA) to be four times that of power. By comparison the value of derived ethanol via fermentation of the hexose sugars (~55% in softwoods, see Table 1.7) is not much above the value of bio-power. Some assumptions of markets for hydrogen and LA have to be made for this comparison. The point is that these products will be able to withstand feedstock price increases, especially if they are produced together in an integrated biorefinery, where the value of a combined LA and hydrogen production plant is almost five times the value of bio-power production alone. Products could be made from the hydrogenation of LA, such as methyltetrahydrofuran, that will be addressed in the latter half of this study.

**Table 2:** Base assumptions of feedstock availability and costs and comparison of approximate value of alternative products: levulinic acid, hydrogen, ethanol, and power and an integrated production of levulinic acid and hydrogen. Also shown is an example of a high value extractive

Biomass Input				
	BDT/Y	\$/bdt	Feed cost, \$/yr	
	250,000	40	\$10,000,000	
Comparative Product Output				
Product	Yield, wt %	Tons	\$/ton	Value
Levulinic Acid <sup>1</sup>	53	132,500	625	\$82,812,500
Hydrogen <sup>2</sup>	10	25,000	2000	\$50,000,000
Bio-Ethanol <sup>3</sup>	28	70,000	380	\$26,600,000
	MWh/ton	MWh	\$/MWh	
Power <sup>4</sup>	1.6	400,000	56	\$22,400,000
Integrated Process				
Levulinic Acid <sup>1</sup>	53	132,500	625	\$82,812,500
Hydrogen <sup>2</sup>	5	12,500	2000	\$25,000,000
<b>Total</b>				<b>\$107,812,500</b>
Extractive	1	2,500	2000	\$5,000,000

1. Yield is theoretical for carbohydrate fraction (75% \* 116/162). Value is assessed as \$2/gal diesel additive).
2. Yield is approximate for gasification process followed by water gas shift. Value is based on the approximate DOE target of \$2/kg (1 kg H<sub>2</sub> = gallon of gasoline energy equivalent).
3. Yield assumes hexose content of 55% is converted to ethanol in 50 wt% yield.
4. Assumes 30% power plant efficiency. Value assumes some green market premium over wholesale electric prices.

Such a scale of plant with two or more major products also sets the stage for the recovery of high value natural products that can be present in minor amounts, but could also be removed under low cost processing steps prior to chemical conversion. For example, an extractive recovered in 1% yield and valued at 2\$/kg could add \$5 million dollars to the annual income for the plant. For this reason, this report begins to compile the details of feedstock composition with the objective of identifying compatible target high value products possibly produced in the integrated LA and hydrogen production plant.

River Valley can take advantage of the native tree types by screening predominant species for both major biopolymer type and potential for high value extractive. For example, Table 3 shows the breakdown of hardwood and softwood wastes based on available county level estimates from the USDA Forest Service [1.1 (25)]. A species level breakdown is given later in this report. The two-county area has a predominance of beech, birch, and maple waste and the high xylose content of these species means that this fraction can be targeted for selective production of xylitol or furan based chemicals. The softwood



residues have a high concentration of pine and so pine extractives will be further screened for potential high value products in conjunction with fractionation technology. The economics of obtaining sorted forest residues will have to be investigated.

**Table 3: The River Valley Biorefinery Project by Feedstock Type [1.1(25)]**

	Hardwood	Softwood	Total
	thousand tons/yr		
Oxford	73	67	140
Franklin	76	42	118
Total	149	109	258
	tons/day		
tons/day	447	327	774

The analysis of the Maine forest product industry that began in this interim report leads to more critical conclusions than other analyses of the industry in the state. However, it shows that there is the potential to recover much more local economic value by focusing on target products, which are at the high value end of the product spectrum. The goal of this market study is to make recommendations that will lead to the maximum recovery of economic value from Maine's natural resource base for the communities that produce the raw material.

### Conversion Technology

This report discusses biomass conversion processes and challenges by assessing commercial readiness as a function of technical reliability, and economic performance of the leading technologies as they are reduced to practice by technology development companies today. As in the paper industry, new bio-products industries in Maine will compete for investment dollars and market shares with other initiatives in the United States and the world. The focus of this report is to develop market options that will return the maximum economic, environmental and social returns to Maine with the minimum investment and risk.

This report does not attempt to identify winning conversion technology companies, but rather describe the risk and benefits of technical approaches relative to the product markets. The quality of the technical reduction to practice and business partnerships are equally as important as the concepts and engineering systems. For that reason recommendation of a particular reduction to practice will not be made here and is considered to be outside the scope of this work. However, the goal of this report and the subsequent final report is that this material can be the foundation of such due diligence efforts.

Three technology approaches are considered here: pyrolysis, gasification, and fractionation. All three of these approaches have issues related to technical reliability and economic performance and hence do not present an immediate

commercial deployment activity in the River Valley area. However, this current state of the art situation presents opportunities for the River Valley area to participate in the demonstration of proposed solutions for the processes and products that present real market advantages.

### *Pyrolysis*

Pyrolysis as a conversion option has not attracted significant research, development, and deployment investment over the past 25 years. Nevertheless, pyrolysis continues to be considered with high interest by groups around the world. The leading proponents of the technology have been groups from Canada and Europe. Much of the attention has been focused on so-called fast pyrolysis processes where high heat transfer regimes are created to minimize the formation of char and maximize the yield of condensable liquid or bio-oil. The simplest reactor for this is a bubbling fixed fluidized bed of sand that runs at 500 °C. Technical issues include the scalability of this configuration and the efficient collection of aerosols. An apparent single-phase product can be obtained if the water content is kept below 25%. A key to stability is to remove all char from the oil that may have been entrained as it can catalyze changes in the oil leading to higher viscosity with time. This is a disadvantage of the fluid bed process as the char leaves the reactor by being attrited and collection of fine particles (<2 microns) is not possible with cyclones so filtration of the hot vapors is necessary. Nevertheless, this process is the base case for the pyrolysis cases addressed in this work.

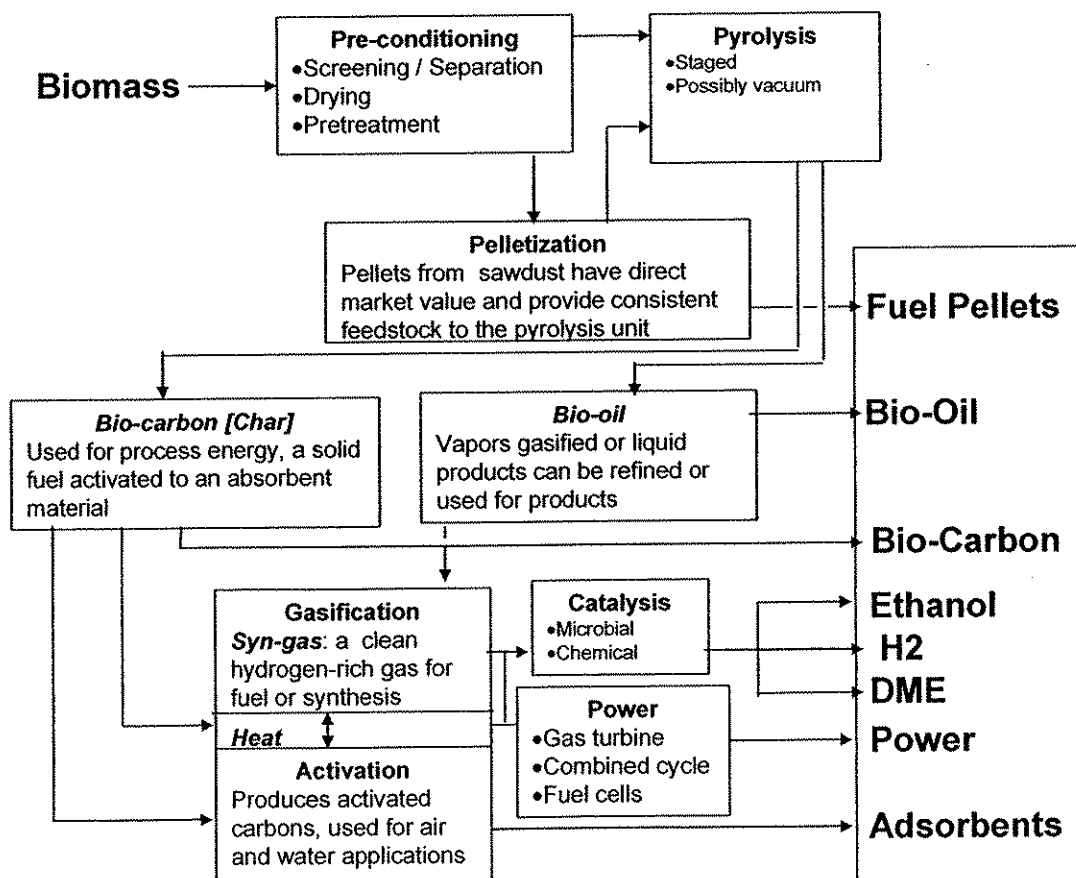
An alternative approach is to allow higher char yields to occur by keeping the temperature below 400 °C and using mechanical conveyance of the feedstock through the reactor where the residence time is on the order of minutes instead of seconds. One example of this is vacuum pyrolysis. The use of mechanical systems such as a heated screw reactor reduces the need for fine particle size and minimizes the need for carrier gas, which alleviates the aerosol problem. Char entrainment is therefore less and the low temperature char will carry off a higher fraction of the heteroatoms (N, S, K, etc.), which means the downstream processing will be simpler. One disadvantage of this approach is that the higher char yield will also produce a higher water yield leading to two-phase bio-oil. This may be acceptable for the case where oil separation is to be performed but may be an issue for upgrading or use of the whole oil. This low temperature approach is also relevant to the staged gasification process described below.

### *Gasification*

Biomass gasification has received more funding for demonstrations in the U. S. and Europe than pyrolysis and hence should be closer to commercial deployment. In general, the application of gasification for heat generation has

had success, but power generation and synthesis applications have faced both technical and economic challenges. The simplest technical approach is an air blown bubbling fixed fluidized bed reactor of sand that runs at 750-850 °C. Technical issues include the presence of nitrogen in the product gas and the cleaning of the gas. Circulating bed designs have advantages over the air blown system but are not considered here because of the complexity. For both pyrolysis and gasification, the work here can be extended to advanced concepts such as circulating beds if necessary.

An alternative approach is included here called staged gasification where the low temperature pyrolysis system is used to produce bio-oil and char. The char is either collected or combusted to provide indirect process energy. The bio-oil is either condensed or gasified by a subsequent thermal or catalytic step. Like the slow pyrolysis concept, the char removes the bulk of the heteroatoms from the process stream and allows the gas phase processes to proceed without the solid phase chemistry. It also means that nitrogen is kept out of the gas stream and downstream conditioning catalysts have less chance of being poisoned. This concept is shown in **Figure 1**.



**Figure 1:** Staged Gasification Process Concept for integrated pyrolysis and gasification technology

## *Fractionation*

The holy grail of biomass conversion is to separate biomass into the three main components: cellulose, hemicellulose and lignin, with minimized degradation products and cross contamination of the major fractions. The three clean fractions can then be converted with more targeted processes for the desired products. Results to date have not identified a clearly superior technical approach that is universally applicable to the wide variety of feedstocks and does not cause degradation to at least one of the three components. Steam explosion is the oldest technical approach dating back to the Mason patent in the 1920's [2.3(33)]. In this process, the chemical and physical action of high-pressure steam combined with the explosive release and rapid cooling of the products has promising applications for targeted feedstocks such as straw and hardwoods. Steam explosion can be combined with acid pretreatment to liberate the cellulosic fiber, but at the expense of more degradation of the hemicellulose. Steam explosion is the base technology considered here for the fractionation pathway. Alternative aqueous systems are being pursued, but not all systems under investigation have released the data necessary for outside evaluation. A promising future option is hot water systems, but they are too far off to be considered further here.

One alternative that has not been adequately demonstrated is the fractionation of wood in multiple solvents. The Clean Fractionation approach of the National Renewable Energy Laboratory (NREL) uses a ternary system of methyl isobutyl ketone (MIBK), ethanol, and water to obtain three clean fractions. This process has not been adequately investigated at a demonstration scale and is addressed here as a representative project for the Fractionation Center, since it still needs partnerships for the demonstration stage. Another promising approach under development is proposed by Pure Vision who uses mild chemical conditions in a thermo-mechanical system based on an auger reactor. They are performing studies with softwoods in addition to herbaceous materials and so their technology will be of great interest to western Maine.

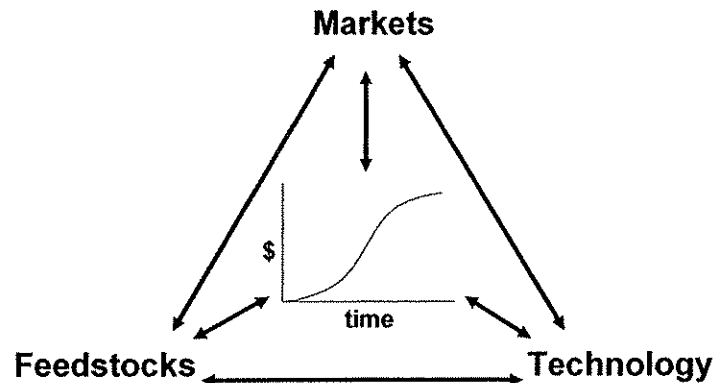
## Market Analysis

The traditional way of defining biomass opportunities is to link the three major categories:

### **Feedstock Supply → Conversion Technology → Product Markets**

Although this scheme is useful in representing the three main areas, it puts the emphasis on available feedstock and conversion technology. Often the distinction is made between **technology push** and **market pull** to emphasize the importance of targeting markets, since technology developers tend to be the main proponents of deployment and thus represent technology as the critical

axis. This project is based on the need to understand all the interaction between these three dimensions and the implications for market penetration (**Figure 2**).



*Figure 2: Conceptual model for the market study*

The objective of this project is to determine the market potential of specific examples of these products and a strategy to implement this plan to support the goals of this community-driven project. This report will lay out a list of possibilities with the principle definition focusing on the relationship of feedstocks with potential markets. These markets need to be classified as mature, emerging, and embryonic. Each of these axes needs to be defined by this sub-classification. Examples of topic areas are shown in **Table 4**.

Market impact and penetration, the hidden dimension in **Figure 2**, is a fourth discussion topic that must be considered. Market diffusion curves as shown in the middle of **Figure 1** have three distinct growth phases. The embryonic phase has minimal impact on the market and takes a significant length of time. The emerging, or exponential, phase shows non-linear behavior and is a time when disruption of conventional markets takes place. The mature phase can only have incremental growth and is vulnerable to competition from low cost suppliers as well as disruptive, emerging technology.

This market study was defined to be consistent with this approach and has addressed the following tasks:

1. Compilation of Feedstock Supply Data and Material Characteristics
2. Assessment of Relevant Conversion Technology Options and Challenges
3. Analysis of Product Market Status and Trends (the major emphasis)
4. Estimations of Market Penetration Levels and Rate

The specific topics being investigated under these four areas are shown in the following sections with the specific topics cataloged and references shown in **Appendix A**.

**Table 4:** Classification of topic areas covered in market study

	Mature	Emerging	Embryonic
Feedstocks	Chips Mill Residues Tall Oil	Energy Crops Forest Residues Mill Residues	Genetic engineering
Technology	Combustion Pulping	Fermentation Fractionation Gasification	Catalysis Enzymatic Reactive Separations
Markets	Power Pulp/Paper	Adhésives Biodiesel Dimethylether Fuel Ethanol Hydrogen Pellets PolyLactic Acid Propylenediol	Levulinic Acid New Monomers Oxyaromatics Xylitol

The analysis of product market status and trends was done to target options for an expanded bioproducts industry in the River Valley area of Western Maine. This report discusses market potential for products by assessing commercial readiness as a function of technical reliability, and economic performance of the leading technologies as they are reduced to practice by technology development companies today. As in the paper industry, new bio-products industries in Maine will compete for investment dollars and market shares with other initiatives in the United States and the world. The focus of this report is to develop market options that will return the maximum economic, environmental and social returns to Maine with the minimum investment and risk.

This report does not attempt to identify winning bioproducts companies, but rather describe the risk and benefits of technical approaches relative to the product markets. The quality of the technical reduction to practice and business partnerships are equally as important as the concepts and engineering systems. For that reason, a recommendation of a particular reduction to practice will not be made here and is considered to be outside the scope of this work. However, the goal of this report and the subsequent final report is that this material can be the foundation of such due diligence efforts.

Seven cases are considered based on applications of pyrolysis, gasification, and fractionation technology platforms. Not all of these cases have the necessary level of technical reliability and economic performance required for immediate commercial deployment activity in the River Valley area. However, their current state of development presents opportunities for the River Valley area to

participate in the demonstration of proposed solutions for the processes and products that present real market advantages.

### *Test Case Description*

For each of the three conversion technology platforms, two base cases have been defined combining specific conversion processes with target products. These will be a small subset of the activities in the three areas of interest, but will serve to develop tools and approaches for analyses that will allow later substitution of alternative process options with additional products as new ideas or interests arise. The six cases are described in **Table 5**.

Two cases are based on pyrolysis. Case 1 products are oxygenated-hydrocarbon liquid fuel and a bio-carbon adsorbent. The fuel is based on the separation of bio-oil into an aqueous and a phenolic fraction. The aqueous fraction is steam reformed to produce hydrogen, which is used to hydro-treat the phenolic fraction. The char product is used for process energy with the excess material activated and marketed as activated carbon. Case 2 products are a fuel oil substitute based on the upgrading of the bio-oil based on acetylation to improve the physical properties by reaction of the bio-oil with methanol or ethanol.

Two cases are based on gasification. The Case 3 product is ethanol where the syngas is converted by catalytic process or by a novel microbial process. The catalytic route makes a mixed alcohol stream with yields of ethanol that may be 50% of the total alcohol production. Markets must therefore be established for the other alcohols such as in the acetylation of bio-oils in Case 3. The microbial route makes acetic acid as a byproduct with the ratio dependent on the operation of the reactor. Case 4 converts the syngas to dimethyl ether via methanol.

Two cases are based on fractionation. Case 5 incorporates the extraction of tall oil type extractives from softwoods as a pretreatment. The wood is then steam exploded with acid catalysis and the cellulose fiber and fines converted to levulinic acid and its derivative, methyl tetrahydrofuran as a fuel additive. Case 6 uses an organosolv process with the recovery of xylose from hardwoods that is converted to xylitol as a high value food additive with the hexose sugars converted to ethanol via fermentation. The lignin is hydro-treated to oxyaromatics using processes similar to Case 1.

**Table 5: Cases for Market Evaluation**

Conversion Technology	Case	Technologies	Products	Technical Issues	Market Issues
Pyrolysis	P1	<ul style="list-style-type: none"> <li>• Auger</li> <li>• Separation</li> <li>• Steam reforming</li> <li>• Hydrogenation</li> </ul>	<ul style="list-style-type: none"> <li>• Hydrocarbon fuel</li> <li>• Bio-carbon</li> </ul>	<ul style="list-style-type: none"> <li>• Mechanical pyrolysis system</li> <li>• Bio-oil yield</li> <li>• Hydrogenation</li> </ul>	<ul style="list-style-type: none"> <li>• Hydrocarbon value as fuel (\$2/gal = \$0.30/lb)</li> <li>• Adsorbent market</li> <li>• Process economics</li> <li>• Process economics</li> <li>• New product</li> </ul>
	P2	<ul style="list-style-type: none"> <li>• Bubbling bed</li> <li>• Acetalization</li> </ul>	<ul style="list-style-type: none"> <li>• Acetylated Bio-Oil blending fuels (AB-Oil)</li> </ul>	<ul style="list-style-type: none"> <li>• AB-Oil properties</li> <li>• Lack of demos</li> <li>• Source of EtOH</li> </ul>	<ul style="list-style-type: none"> <li>• Process economics</li> <li>• Process economics</li> <li>• New product</li> </ul>
Gasification	G1	<ul style="list-style-type: none"> <li>• Staged</li> <li>• Syngas conversion                             <ul style="list-style-type: none"> <li>◦ Fermentation</li> <li>◦ Catalysis</li> </ul> </li> </ul>	<ul style="list-style-type: none"> <li>• Ethanol</li> </ul>	<ul style="list-style-type: none"> <li>• Staged not demonstrated</li> <li>• Fermentation performance</li> <li>• Catalyst selectivity</li> </ul>	<ul style="list-style-type: none"> <li>• Process economics</li> </ul>
	G2	<ul style="list-style-type: none"> <li>• Bubbling bed</li> <li>• Conditioning</li> <li>• Catalysis</li> </ul>	<ul style="list-style-type: none"> <li>• MeOH</li> <li>• DME</li> </ul>	<ul style="list-style-type: none"> <li>• Gas conditioning</li> </ul>	<ul style="list-style-type: none"> <li>• DME markets</li> <li>• Process economics</li> </ul>
Fractionation	F1	<ul style="list-style-type: none"> <li>• Extraction</li> <li>• Steam explosion</li> <li>• Acid catalysis</li> <li>• Steam reforming</li> <li>• Hydrogenation</li> </ul>	<ul style="list-style-type: none"> <li>• Tall Oil Chemicals</li> <li>• Levulinic Acid</li> <li>• Methyl-THF</li> </ul>	<ul style="list-style-type: none"> <li>• Feedstock issues</li> <li>• Continuous system</li> <li>• Water management</li> </ul>	<ul style="list-style-type: none"> <li>• Process economics</li> <li>• LA, MTHF markets</li> <li>• Tall oil supply</li> </ul>
	F2	<ul style="list-style-type: none"> <li>• Organosolv</li> <li>• Fermentation</li> <li>• Hydrogenation</li> </ul>	<ul style="list-style-type: none"> <li>• Xylitol</li> <li>• Ethanol</li> <li>• Oxyaromatics</li> <li>• Levulinic Acid</li> <li>• Methyl-THF</li> </ul>	<ul style="list-style-type: none"> <li>• Safety</li> <li>• Continuous system</li> <li>• Water management</li> </ul>	<ul style="list-style-type: none"> <li>• Process economics</li> <li>• Xylitol market</li> <li>• Oxyaromatic market</li> </ul>



The conversion system for each of these cases is presented with an estimate of production costs and economic potential. The products can be classified by the state of knowledge of the product and the market. Ethanol and xylitol have known properties and markets so deserve the most consideration. Dimethyl ether has well known physical and chemical properties but it is not a major commodity in the United States, so eventual market penetration is more uncertain than ethanol. The acetylated bio-oil and oxyaromatics have unknown properties and performance and no markets so they fall into a third class for consideration.

A process was established to compare the six cases and the results are shown in **Table 5** for four of the thermochemical options. Weightings (that add to 100%) are assigned to technical merit, economic merit, and challenges and then criteria for each are given importance factors by assigning them rating factors of 1, 4, 7 or 10. Each case is likewise ranked for each criterion using the same scoring system. The goal is to identify the best options and the most important barriers for each case. The results in **Table 6** show that the case P2a for acetalization of bio-oil was the highest ranked and was so because of perceived economic merit in capital and operating cost and time to market.

The next highest score was for cases G1b and G2, the conversion of syngas to mixed alcohols or DME. These cases are perceived to have the more desirable products but require more difficult operating conditions and more investment and operating costs.

Case G1A, which uses the novel microbial processing of syngas received the lowest score because of uncertainties about the process. This process is now in the hands of a development company, which is readying for commercial deployment. It is difficult to evaluate the process of many technical options that are primarily in the hands of entrepreneurial companies without a history of publications. In fact, the selection of technology is important in establishing time to market. The objective of an entrepreneurial company is to succeed beyond any such expectations so it is not appropriate in this kind of study to select winners or losers, but rather define broader scenarios that can be updated as successes and failures are observed at the demonstration level or in the market place over the coming years.

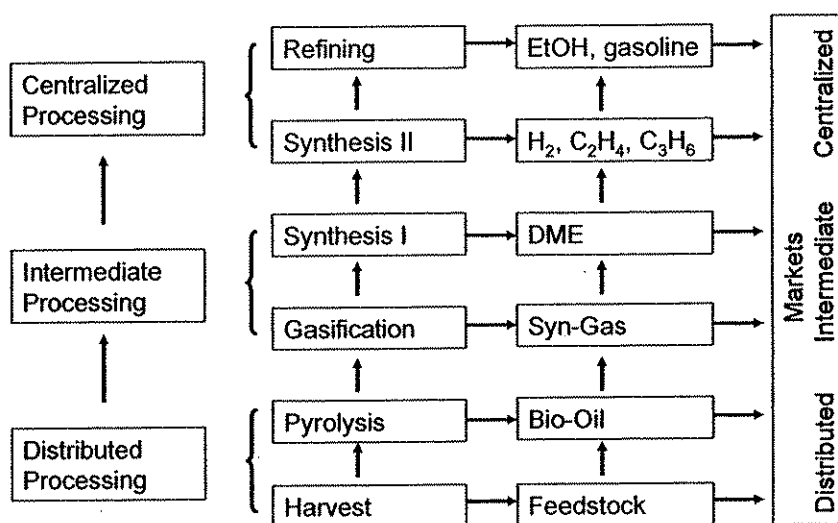
This evaluation process is being distributed for assessment by stakeholders in the Maine Biorefinery Project and the compiled results will be included in the final version. It will also include evaluation of all 6 six cases and the super case

**Table 6: Multiple process attributes with a weighted comparative analysis of thermochemical scenarios [Appendix A]**

Case Description	Product Value (\$/lb)	Cases			
		P2a - Bubbling Bed (Fast) Pyrolysis w/ Acetalization of Bio-Oil	P2b - Bubbling Bed Slow Pyrolysis w/ Acetalization of Bio-Oil	G1a - Pyrolysis & Gasification w/Fermentation Syngas to Ethanol	G1b & G2 - Pyrolysis & Gasification w/Catalytic Syngas to Alcohols / DME
<b>Products</b>		<b>wt% of dry feedstock produced</b>			
Bio-Gas / Methane-rich stream	0.15	5	10	0	0
Bio-Oil	0.10	68	15	0	0
Char	0.04	10	10	14	0
Char into Activated Carbon	0.30	0	20	15	0
Hydrogen-rich stream					
Steam (electricity production)					
Ethanol & other light H.C. liquids	0.20	0	0	26	64
<b>Total Product Value (\$/lb dry feedstock)</b>		<b>0.080</b>	<b>0.094</b>	<b>0.103</b>	<b>0.128</b>
<b>Process Blocks</b>					
Pyrolysis		X	X	X	X
Gasification				X	X
Involved Solids Separation		X	X		
Biochemical Liquefaction				X	
Catalytic Liquefaction					X
Water / HC Liquid Distillation Separations		X	X	X	X
Anaerobic Digestion					
<b>Technical Merit</b>	<b>30%</b>	<b>7</b>	<b>7</b>	<b>7</b>	<b>8</b>
Types and Quantities of Products	10	7	4	10	10
Operating Conditions	7	7	10	4	4
Minimal Energy Input to Process	7	7	7	7	10
<b>Economic Merit</b>	<b>50%</b>	<b>8</b>	<b>8</b>	<b>6</b>	<b>6</b>
Minimal Capital/Investment Costs	7	10	10	7	4
Minimal Production Costs	7	10	10	7	7
minimal Time to Market	4	10	10	4	7
Product Value	10	4	4	4	7
<b>Challenges</b>	<b>20%</b>	<b>9</b>	<b>7</b>	<b>5</b>	<b>9</b>
Process Reliability	7	10	10	4	7
Product Stability	7	7	7	4	10
Transportation & Storage	10	10	4	7	10
<b>Overall</b>	<b>100%</b>	<b>7.9</b>	<b>7.2</b>	<b>6.0</b>	<b>7.4</b>

These market maturity factors taken into consideration in the definition of Case 7, show several of these materials as intermediates and by-products that can be

integrated over time in a large-scale, high-impact integrated bioproducts industry for Maine. Case 7 is a three-stage process, shown in **Figure 3**, which moves from small-scale, distributed operations close to the feedstock to very large operation inside an existing petroleum refinery such as located in New York harbor. In the first stage, distributed processing throughout the Northeast, produces bio-oil. The proposal is to begin this development project with Maine as the site of the proposed demonstration project.

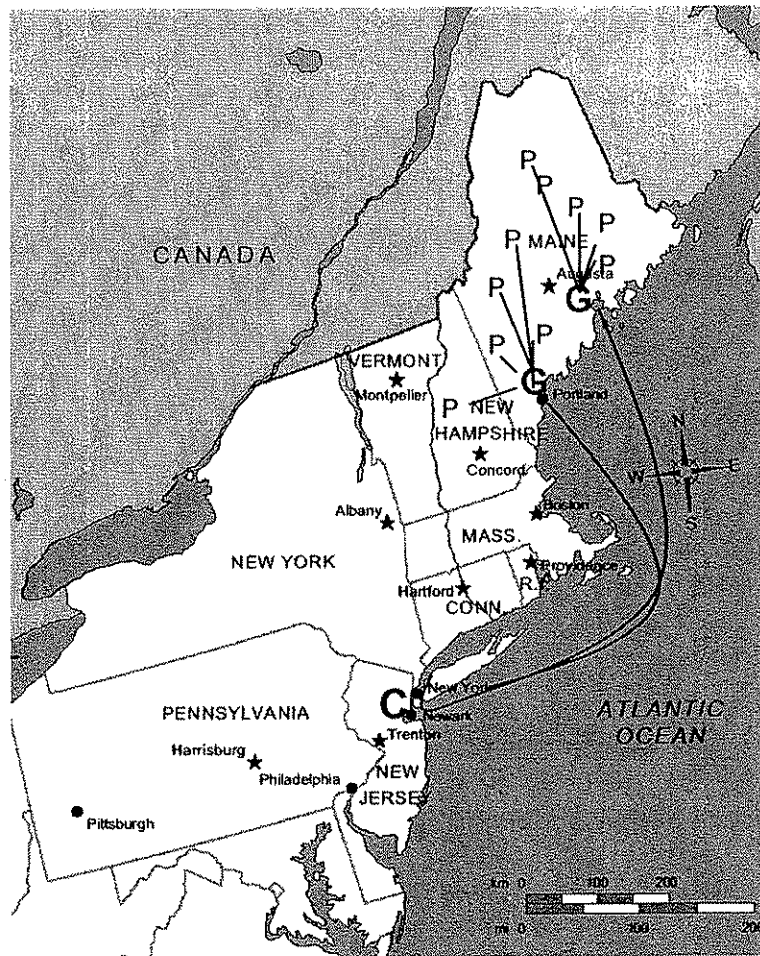


**Figure 3:** The three-stage parallel and serial conversion pathway based on the transportable intermediates of bio-oil and DME for converting wood residues into transportation fuels such as ethanol and gasoline.

**Figure 4** shows bio-oil shipped to a strategically located second stage processing plant where it is converted via catalytic gasification and synthesis to dimethyl ether (DME). DME is then transported as a compressed liquid via sea transport to a third stage centralized processing facility located at a petroleum refinery, such as in the New York Harbor area, where it undergoes large scale catalytic conversion to olefins. The olefins can be utilized in a variety of ways, such as the synthesis of ethanol, for alkylation of gasoline feedstocks, or for polymer synthesis. Alternatively, the DME can be converted to hydrogen for use in processing or as a transportation fuel as that market develops.

**Figure 3** shows the concept as described, however other specific conversion steps and intermediates can be envisioned. For example, omitting the bio-oil step in certain locations in favor of centralized large-scale gasification and the gasification intermediate could be methanol instead of DME or Fischer-Tropsch mixed hydrocarbons. Determining the optimum specific path or mix of pathways, optimizing economics and efficiency requires analysis. As shown in **Figure 1** each intermediate product will also have local market opportunities that should be evaluated as part of this integrated strategy. For example, bio-oil can be

derivatized for use as a substitute for heating oil, syngas can be converted to power, and DME may be used as a replacement for propane.



**Figure 4:** Illustrative deployment of three stages of conversion plants to integrate the forest biomass resource of Northern New England with the Northeast refinery industry [ ()] Map??

Each stage 1 distributed processing plant converts 750 dry tons/day of residual wood into bio-oil. Each area that provides feedstock for a paper mill can support this level of residue so the conservative potential is for at least ten such bio-oil plants in Maine.

These regional bio-oil plants will feed two intermediate plants located at current fuel depots in Portland and Bucksport. Each of these intermediate plants can synthesize approximately 650,000 tons of DME/year from the bio-oil provided by the regional plants. DME can be transported back to a refinery in the same ships that deliver refined petroleum products to Maine from the refinery.

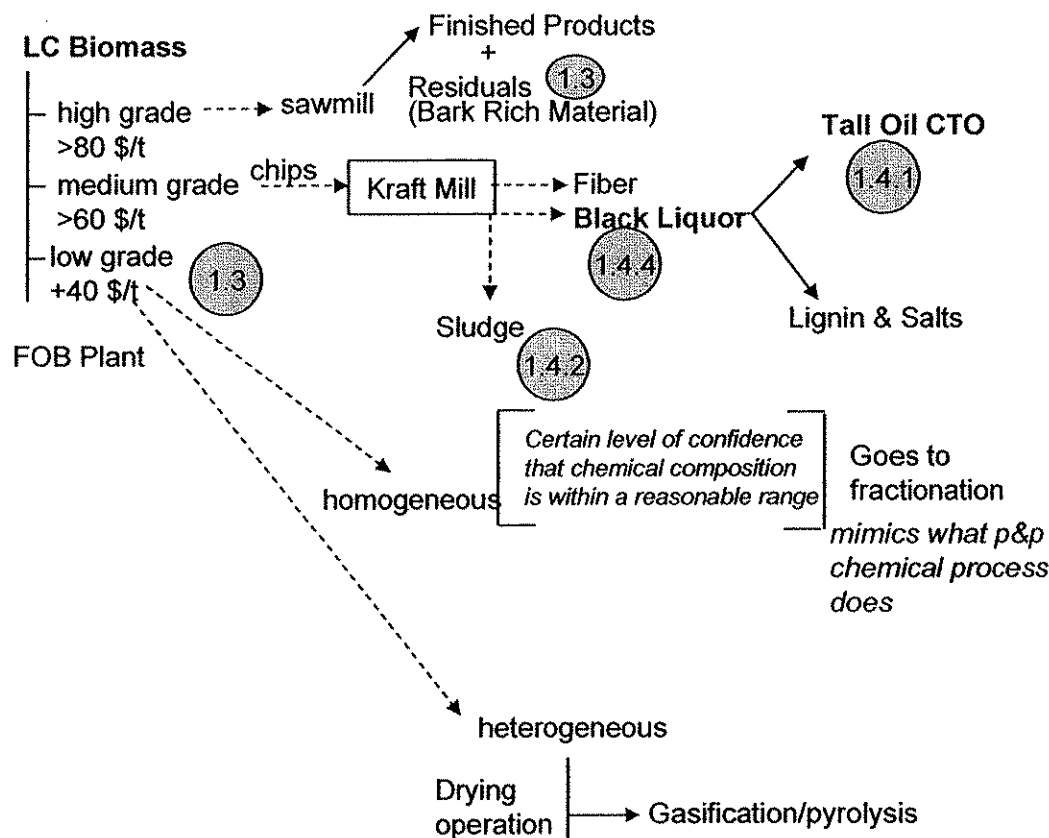
At the refinery, the DME can be processed as a gas or liquid feed and used in a variety of processes. For example, it can be converted to hydrocarbons such as C<sub>2</sub> and C<sub>3</sub> olefins. Assuming the theoretical yield of propylene from DME as an example, the amount produced at the refinery from the two Maine DME facilities is equivalent to 1.6 billion lbs of propylene with an approximate value of 400 million dollars. The potential amount of wood residues in Maine may possibly sustain 100 times this amount. Assuming other DME transportation routes, similar stage 1 and stage 2 plants could be envisioned in New Hampshire, Vermont, New York and Pennsylvania to feed the stage 3 operation at the refinery. **Figure 4** illustrates the distribution of plants in Maine

Although there are other potential pathways that could be used in practice, this initial description uses two transportable intermediates: bio-oil and DME. The bio-oil can be shipped, stored and pumped at a higher energy density than wood chips. It also has more potential for gasification by new approaches and could support a large-scale DME plant equivalent to a 3500 dry tons/day biomass gasifier thus achieving significant economies of scale. The conversion to DME means that a product with well-known, desirable properties is then transported to the refinery where it can be easily integrated with existing chemical operations. In this example, DME is converted over a ZSM-5 catalyst to light olefins, predominantly ethylene and propylene. Although these products can be used in conventional refinery operations, there is the potential to convert ethylene to ethanol and propylene to polypropylene. DME could also be converted to hydrogen for upgrading purposes. It may also be that DME will have its own value as a fuel for diesel engines or as a replacement for propane in the future. Since all these products will be considered renewable, there may be tax and carbon incentives for integrating this approach even at this scale, which will be minor compared to normal refinery operations.

The DME concept suggests an immediate rationale for placing a high priority on the development of technologies and systems that can be applied to the forest biomass resource. The current emphasis in the U. S. DOE program on biological processing for specific agricultural residues is not relevant to the forest resource base, and hence not to regions of the United States with significant forest resources. Besides the Northeast, the DME concept is highly applicable to the Northwest, the Great Lakes States, and the Southeast, thus expanding the potential impact of biomass to most of the country. The integration of forest resources with the existing petrochemical refinery will also allow rapid deployment and economies of scale as well as the major participation of energy companies in defining the process and its reduction to practice. The emphasis on delivery of a conventional feedstock such as DME to the refinery will also make the integration easier for the existing industry. This approach will also lead to the development of smaller scale conversion systems at stages 1 and 2 as capabilities are established close to the feedstock and markets for new energy products are developed.

## 1.0 Compilation of Feedstock Supply Data and Material Characteristics

The feedstock strategy has the topical areas shown in **Figure 1.1**. It is assumed that the high grade feedstock will go to high end use at sawmills, but the sawmill residues, such as bark and sawdust, will be available for a biorefinery and represent near-term opportunity feedstock since they will be clean materials compared to forest residues and available year round.



**Figure 1.1:** Overview of the feedstock sources and conversion targets of interest. Numbers refer to outline shown in Appendix 1 [Chornet, 2005] [2.0(9)].

The medium grade biomass goes to pulp but there are opportunities associated with the recovery of the crude tall oil (CTO) that is not separated in Maine but burned in the black liquor recovery boiler. Another byproduct of interest is the sludge that is produced from the water treatment process.

The major long-term feedstock is the low-grade biomass comprised of forest residues. This stream can be subdivided into two grades. Fractionation processes require more homogeneous feedstock since reaction severity must be optimally set depending on the nature of the feedstock. The more heterogeneous feedstock can be used by thermochemical conversion, which

includes combustion, gasification, and pyrolysis. The homogeneous stream can be used wet, but the thermochemical processes require drying. As discussed in the Summary, the best opportunities will be a combination of fractionation and thermochemical processes. The thermochemical operations can provide process heat and the integrated operation can obtain high energy efficiency and process a wide range of potential feedstocks. Much can be modeled on the world class paper mills in the western Maine region.

## 1.1 Maine's Position in the North American Forest Product Industry

### *1.1.1 Employment*

The forest products sector employs 1.5 million people in the U.S. and stands among the top ten manufacturing employers in 42 states. However, since 1997, more than 50,000 jobs have been lost and 98 pulp and paper mills have closed as well as 71,000 jobs lost in the lumber and wood products industry [1.4.5(16)]. Factors are:

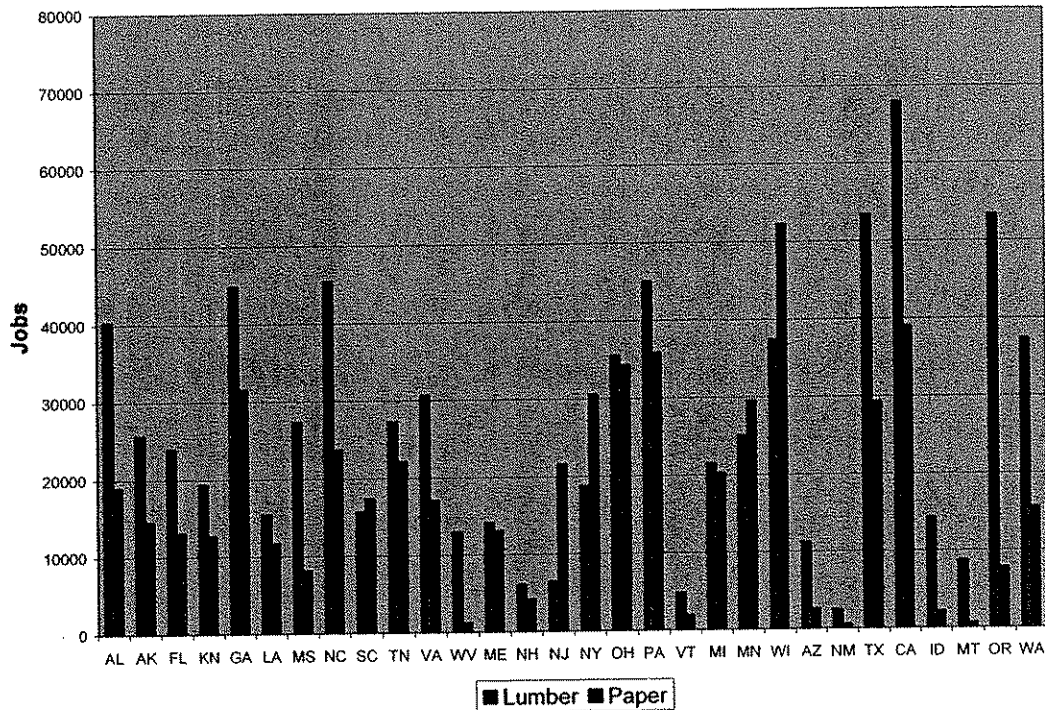
- Reduced access to fiber in last decade
- Timber from public lands reduced by 75%
- Environmental regulation that adds to capital cost burden
- Energy costs, although industry self generates 60%, are a major reason for plant closings
- US tax rates discourage investment compared to other countries
- International trade barriers: most trading partners have higher tariffs on forest products as well as lower sustainability standards.

Maine's position in the changing North American and world markets needs to be understood as it relates to the opportunities and threats that must be considered in any new endeavor. The goal for Maine is not only creating products for existing markets but also, creating new products that must establish markets.

Maine is 90% forested and 96% of the forest is productive timberland [1.1(15)]. No other state has this level of timberland coverage. Maine also has the highest level of private ownership of timberland [1.1(79)] It is worthwhile to compare Maine with other states to understand the unique potential and challenges that will be faced as new products and markets are addressed.

**Figure 1.2** shows the total employment in the forest product industry in the forest product states of interest. Surprisingly, Maine does not stand out as a leading employer compared to the other major forest product states. Wisconsin is the leading paper producing state and has significantly more jobs in the industry than Maine. The reasons for this phenomenon are outside the scope of this study. It may indicate criteria for bio-product selection that places a premium on products, which can have a high degree of vertical integration within the state rather than the production of feedstock-quality products sent elsewhere for refinement and

integration with the final manufactured good or service, which would imply high paying jobs.

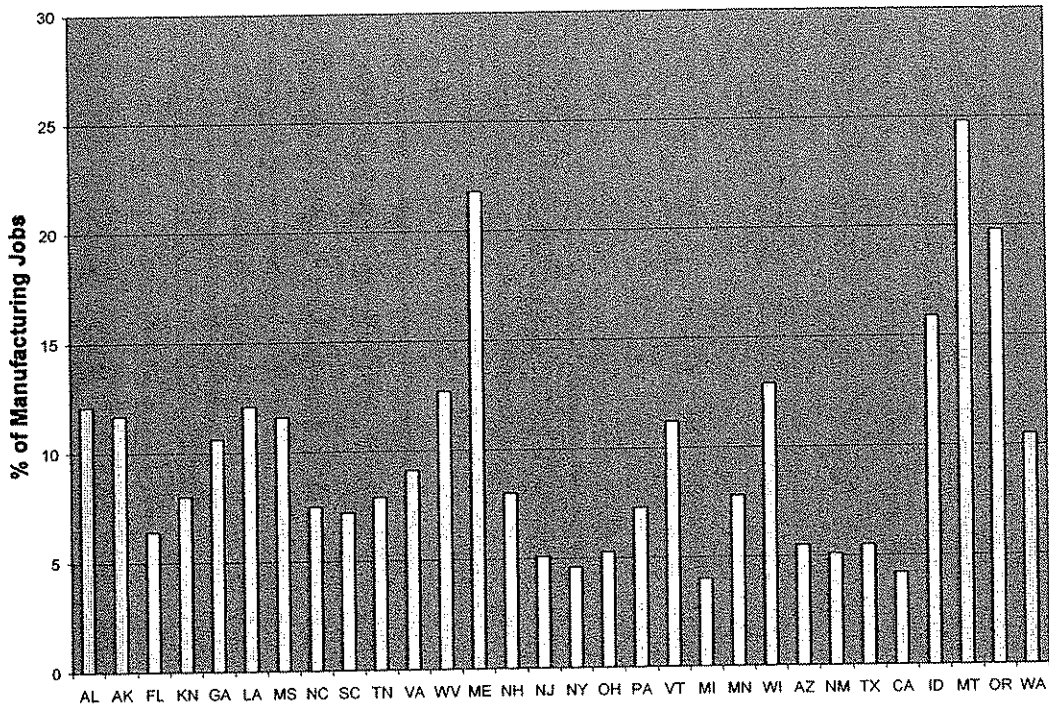


**Figure 1.2:** Employment in forest and paper industry [1.0(38)]

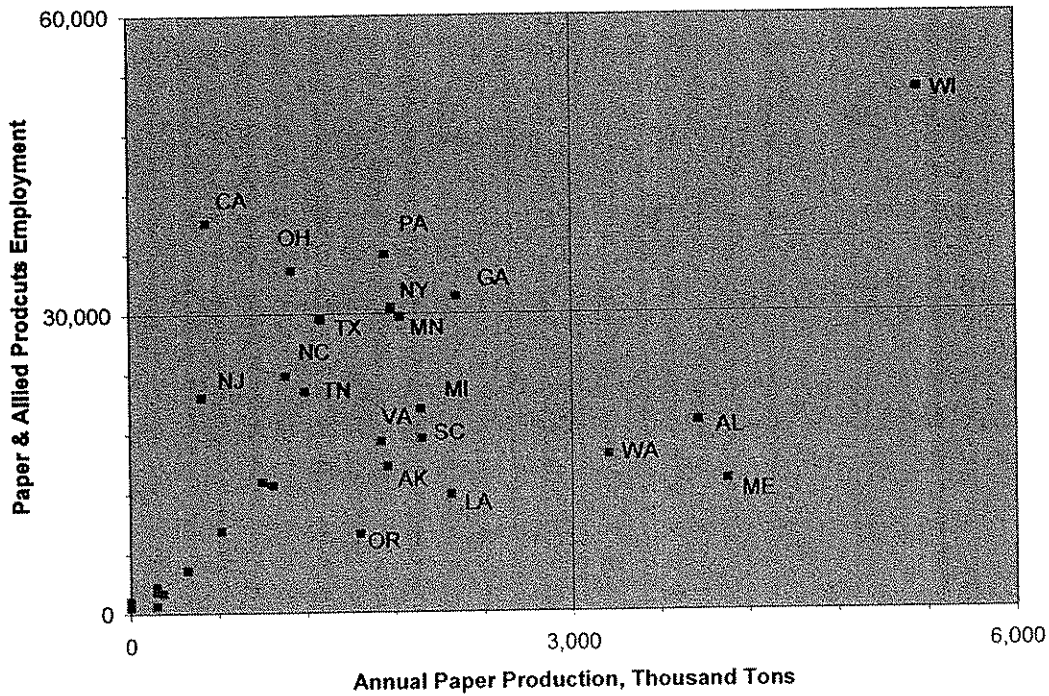
Maine does stand out as having one of the highest percentages of manufacturing jobs in the forest products industry as shown in **Figure 1.3**. This indicates the high reliance that the state has on the industry compared to the more diversified states such as Wisconsin and Georgia.

To understand better this low labor force in Maine, **Figure 1.4** shows the number of jobs plotted versus total paper produced. Clearly, Wisconsin is in a different class compared to the other major paper producers. Maine is clustered with Alabama and Washington at a below average rate. Another group of 14 states has significantly more jobs in the paper industry despite a lower production rate than Maine.



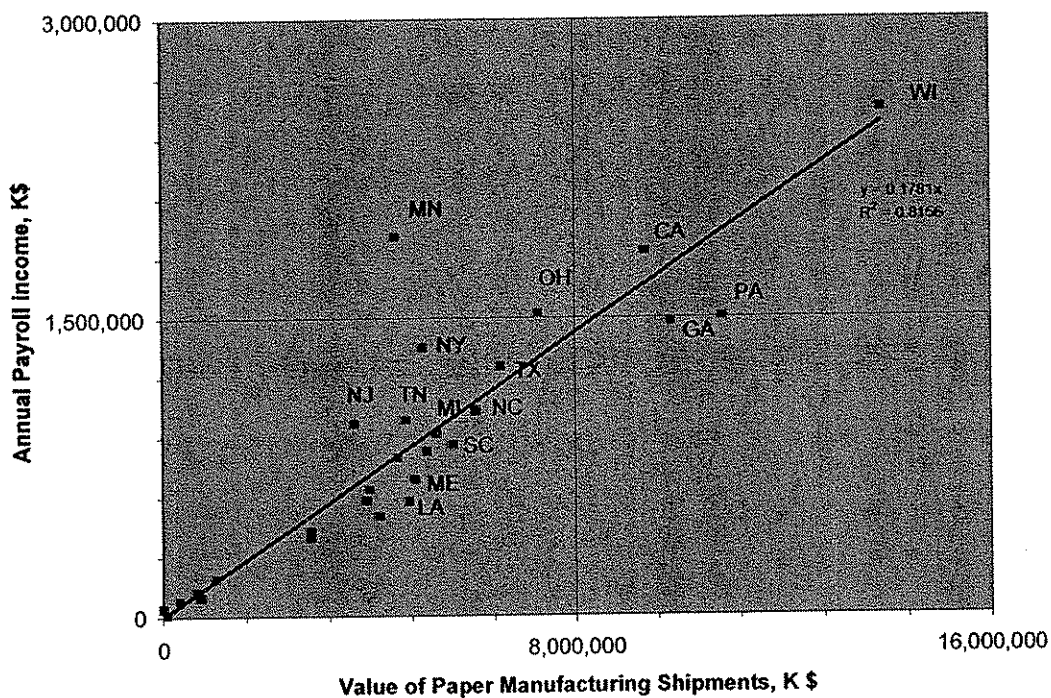


**Figure 1.3:** Employment in forest and paper industry in major forest product states: percent of manufacturing jobs [1.0(38)]



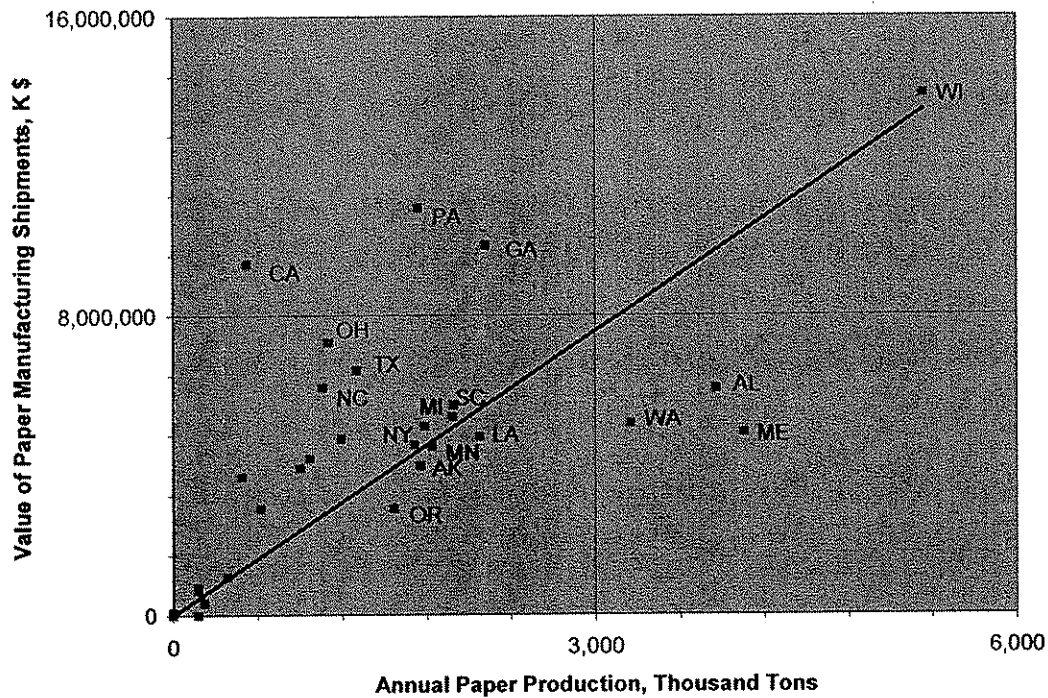
**Figure 1.4:** Paper employment versus paper production [1.0(38)]

Figure 1.5 shows the annual payroll income as a function of the value of paper manufacturing shipments [1.0(38)]. **The conclusion from this presentation is that Maine is not recovering as much value from its natural resource base.** Even New Jersey's paper industry payroll has a higher annual income than Maine. Given Maine's high volume of paper products, low total value, and low payroll when compared on a product value basis, it is clear that Maine must not vertically integrate to the same extent as other regions of the country, most notably, California. This has major implications for the objective of this study that higher value products and more vertical integration must be stressed over high volume resource extraction and commodity product manufacturing (i.e., fuels and power) if the goal is local economic impact. Otherwise, the value of the natural resource base is not fully exploited and this means that the risks of potential long-term environmental costs are not justified.



**Figure 1.5:** Annual payroll income as a function of the value of paper manufacturing shipments [1.0(38)]

Figure 1.6 shows another view of this data and again illustrates that Maine is beneath the curve in value versus volume.



**Figure 1.6:** Value versus volume of paper [1.0(38)]

### 1.1.2: The Industrial Investment in Maine's Forest Product Industry

Maine has no corporate leadership presence in the state, but the industry has always been heavily invested in Maine land, though that is changing. The non-industrial private ownership class increased by 1.9 million acres, about 10% of the forestland, and there was a corresponding 1.6 million acre decrease in industry ownership between the Third and Fourth Annual Inventory Report on Maine's Forests between 1995 and 2002 [1.1(178)]. The impact of the large-scale transfer of Maine land is an issue for future ventures that must rely on this resource base. This debate began in the 1980's when Diamond Occidental put a million acres of northern forest up for sale. At that time a call was made for a regional approach for the 26 million acre Northern Forest which includes timberland in Maine, New Hampshire, Vermont, and New York [1.0 (305)].

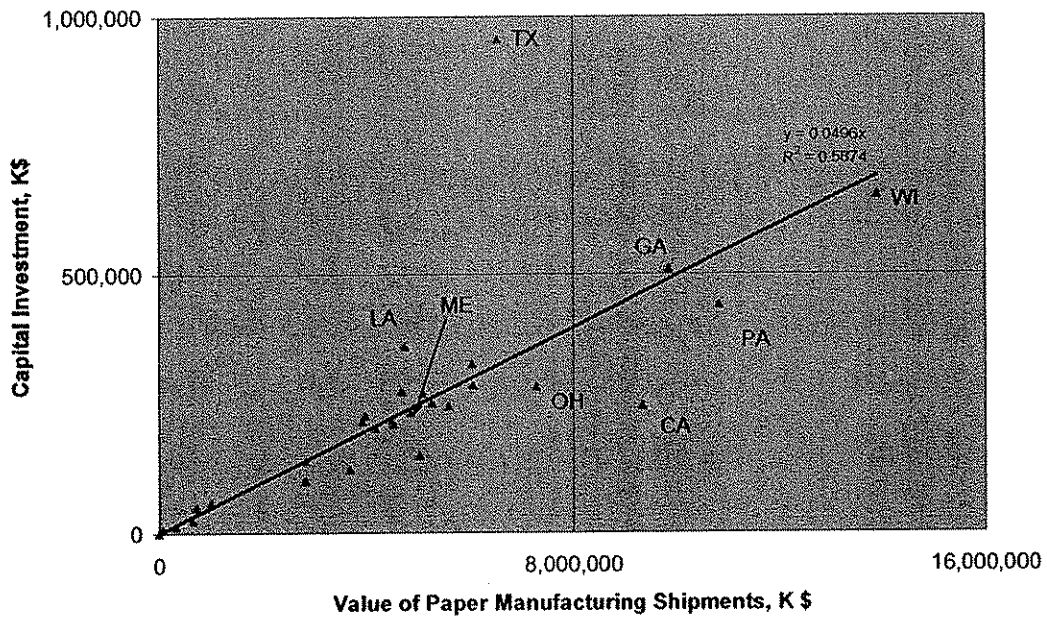
The paper companies are the major driver in understanding and predicting the future of Maine's biomass resource. The current paper mills in Maine are listed in **Table 1.1**.

**Table 1.1: Major Forest Products Companies in Maine [4.2.1.1(86)]**

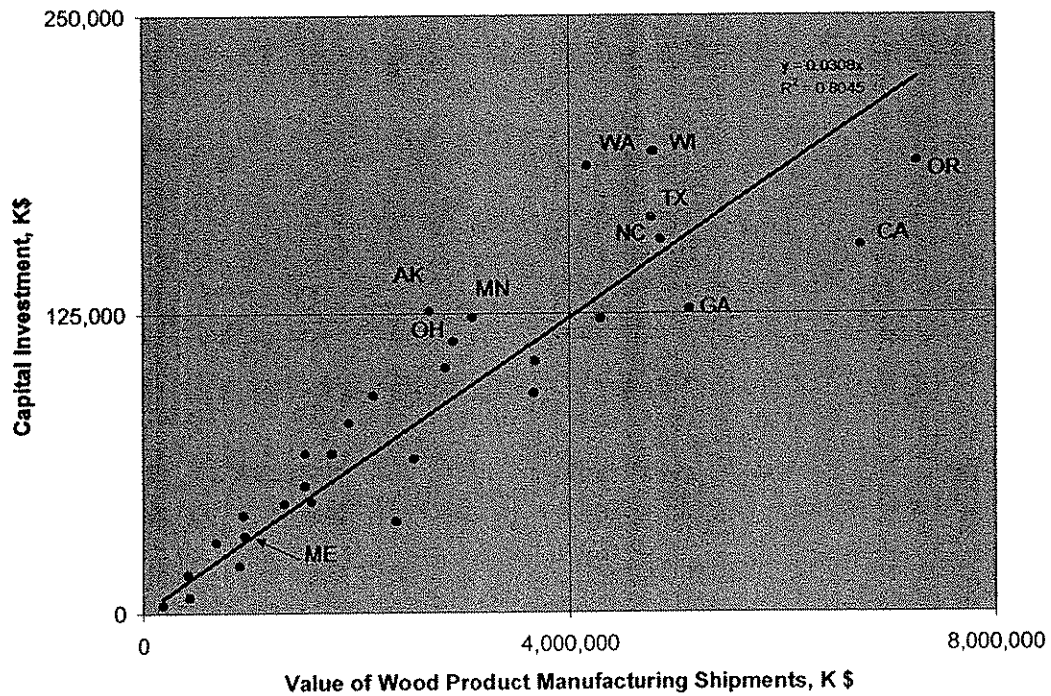
Company	Headquarters	Net Sales Billion\$ (2003)	Maine Operation
<b>International Paper</b>	Purchase, NY	25 <sup>1</sup>	<b>Jay</b> Bucksport
Georgia-Pacific	Atlanta, GA	18 <sup>1</sup>	Old Town
<b>MeadWestvaco</b>	Stamford, CT	8 <sup>1</sup>	<b>Rumford</b>
Domtar	Montreal, QUE	3.4 US\$ <sup>1</sup>	Woodland
Fraser Papers	Toronto, ONT	1.0 US\$ <sup>1</sup>	Madawaska
Katahdin Paper	E. Millinocket, ME	0.5	Millinocket East Millinocket
Lincoln Paper and Tissue	Lincoln, ME	N/A	Lincoln
Madison Paper	Norwalk, CT	1.5	Madison
SAPPI	Boston, MA	4.2 <sup>1</sup>	Skowhegan Westbrook
Wausau-Mosinee Paper	Mosinee, WI	1.0 <sup>1</sup>	Jay

**Figure 1.7** shows the capital investment in the U. S. paper industry [1.0(38)]. Again, Wisconsin is at the top of the trend for most states with the notable exception of Texas and Louisiana where capital investment greatly exceeded the 5% overall average. California is significantly below the average, which is notable given the high value of paper shipments shown in **Figure 1.6**. There is nothing to distinguish Maine in terms of investment dollars since it is on the regression line and in the cluster of other states.

**Figure 1.8** shows capital investment in wood product manufacturing by state as a function of value of industry shipments [1.0(38)]. In this category, Maine is near the bottom of capacity among the states considered, but the level of capital investment is close to the overall average of about 3% of annual sales.



**Figure 1.7:** Capital Investment in paper manufacturing by state as a function of sales [1.0(38)]

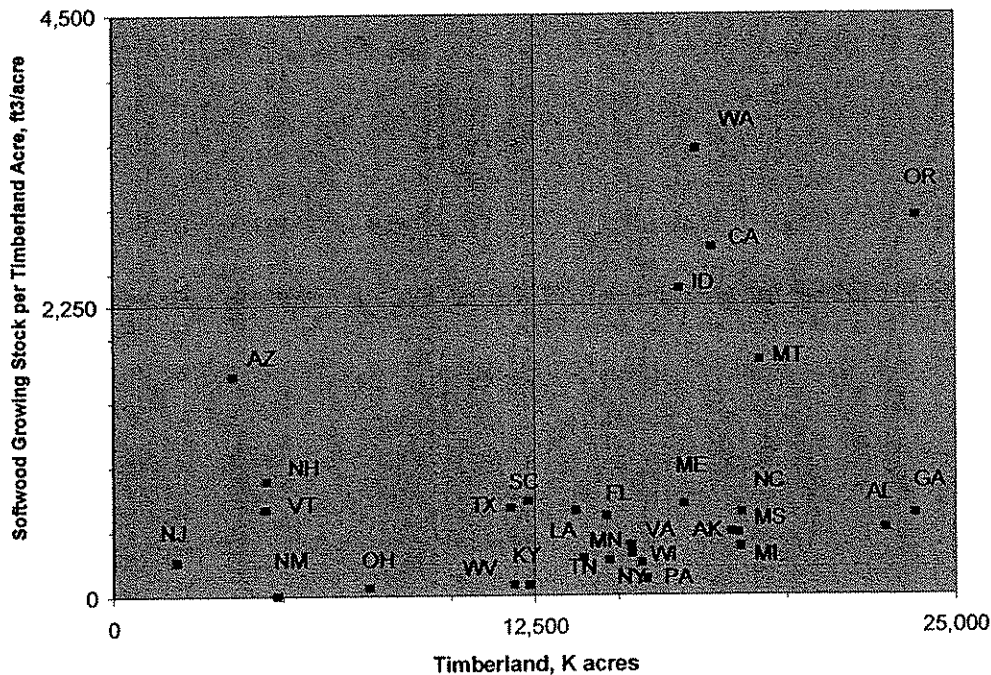


**Figure 1.8:** Capital Investment in wood product manufacturing by state as a function of value of industry shipments [1.0(38)]

## 1.2 Feedstock Supply

The Fourth Annual Inventory Report on Maine's Forest [1.1(178)] shows an improving inventory of trees on total stable acreage. Although pulpwood inventory is expected to decline less than 1% a year for the near future, an in-growth of young trees is expected to reach market status.

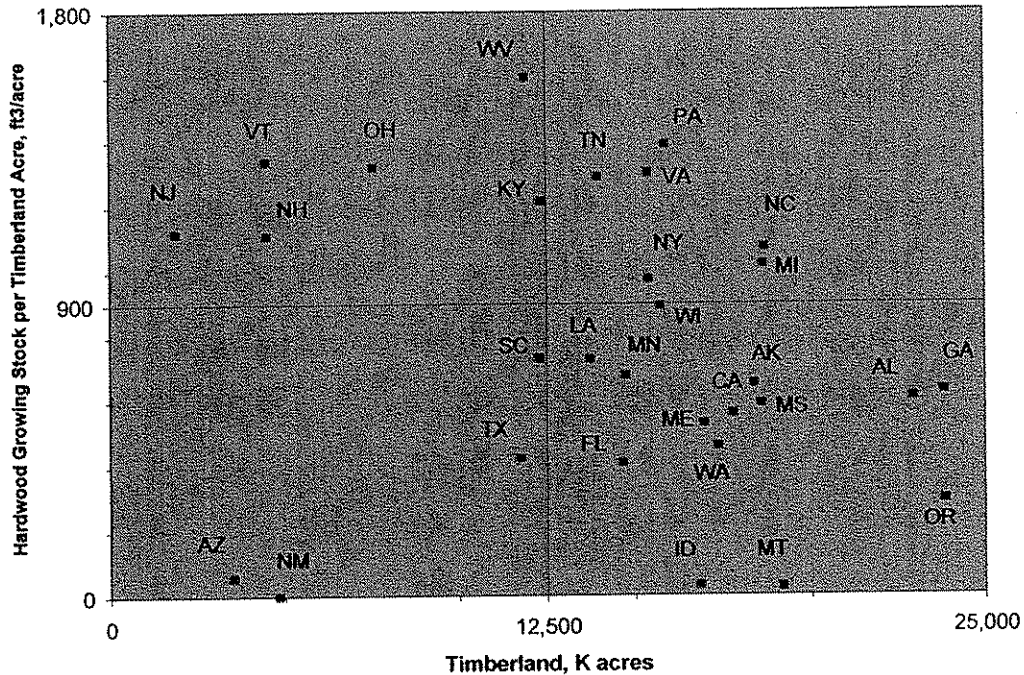
**Figure 1.9** shows the distribution of softwood growing stock relative to timberland area [1.0(38)]. Clearly, the western forest product states are in a different class of overstocked forests. Furthermore, the Healthy Forest Initiative [1.0(98)] is likely to subsidize the removal of this wood to mitigate forest fire danger. This new supply of feedstock is a major concern because of the impact it will have on the competitive situation for new product initiatives based on Maine softwoods. Maine remains at the top of the band of the paper states and its young forest is another asset.



**Figure 1.9:** Intensity of softwood growing stock relative to timberland area [1.0(38)]

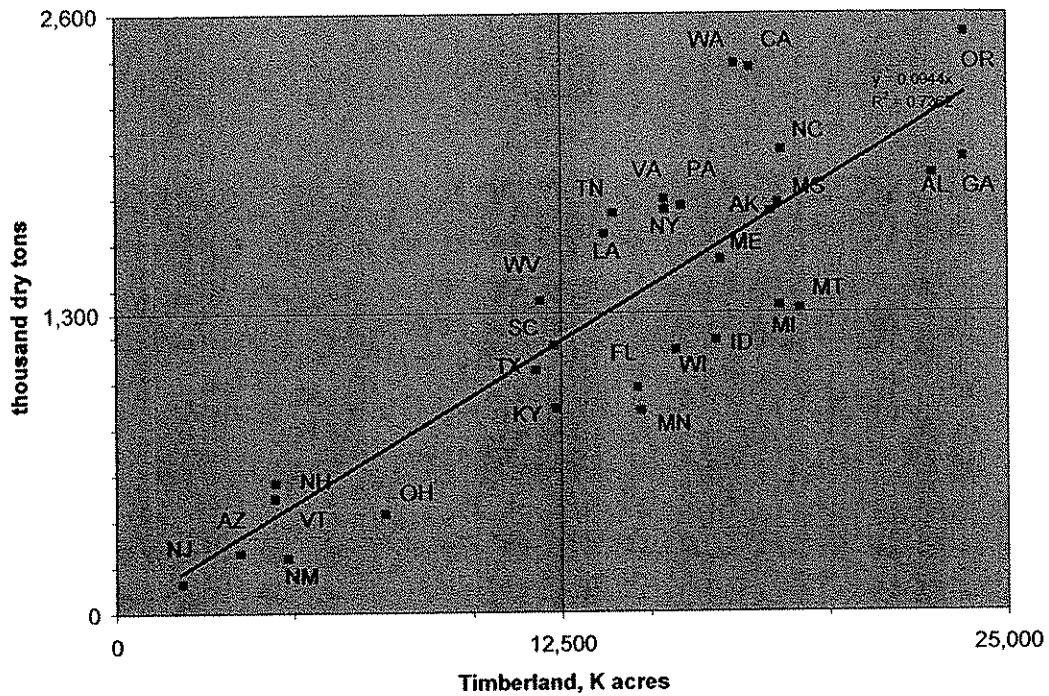
**Figure 1.10** shows the growing stock intensity of hardwoods relative to timberland area [1.0(38)]. The high intensity high timberland states are from the Appalachian region: PA, TN, VA, NC, NY, KY and WV. Maine has half the density of these leading states for hardwood. **However, this may be misleading for western Maine, since they have higher amounts of hardwoods than northern and eastern Maine and thus may be a strategic asset for the River Valley area especially given the high density in NH and VT. A more specific analysis based on county clusters rather than state**

boundaries should be performed to assess western Maine's ability to compete with the Appalachian region in hardwood-derived products,



**Figure 1.10:** Density of hardwood growing stock relative to timberland area [1.0(38)]

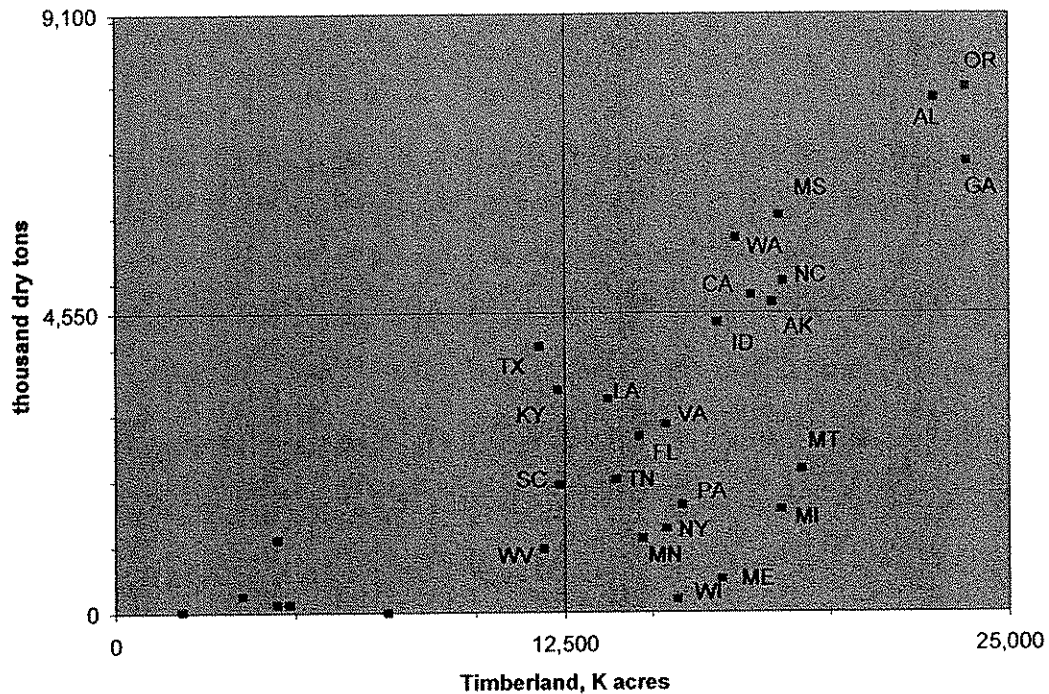
Figure 1.11 shows the Oak Ridge National Laboratory estimates of available forest residues for less than \$50/dry ton [1.0(126)]. The estimate for Maine is 1,529,100 dry tons/year, which is on the regression line for the states considered.



**Figure 1.11:** Estimates (1999) of forest residues available for less than \$50/dry ton [1.0(126)]

The ORNL unused mill residue (Figure 1.12) estimates for Maine are quite low relative to other forest product states. The total residue amount is 500,000 tons in the state according to the USDA [1.1(25)]. In almost all cases, the material used now for a variety of functions includes energy generation and only 40,000 tons is unused, which is not to say that higher value products could not divert that total from lower value fiber or fuel byproducts.





**Figure 1.12:** Estimates (1999) of mill residues available for less than \$50/dry ton [1.0(126)]

According to the *Fourth Annual Inventory Report on Maine's Forest* [1.1(178)], 97% of the forestlands are classified as productive timberland, with an estimated inventory of 277 million cords of pulpwood quality or better stock. This was a 9% increase from the 1995 inventory. Pulpwood inventory declined by less than 1% annually and that is expected to continue until the in-growth of young vigorous trees reaches merchantable sized classes.

Disease and insects are always an uncertainty that can affect future forest health and feedstock availability and cost. In Western Maine, balsam fir mortality exceeded the gross growth estimate and resulted in an overall annual percentage change of -3.8% in the stocking level in the last inventory. Over harvesting is also a possible threat to long term sustainability. For example, in Western Maine, white pine harvest represented 25% of the total removal and was the major contributor to the annual negative percentage change of -3.4%.

Overall, the USDA inventory leads to the conclusion that there is a high degree of confidence of ample feedstock supply over the life of an appropriate sized plant. Furthermore, making a suite of integrated products that are closer in value to paper than power so that it can effectively compete as feedstock prices vary over time.

### 1.3 Species Distribution

This section describes the distribution of the major tree groups in Maine and their relative importance to the western Maine region. There are three major forest types in Maine named for the predominant species: spruce/fir (35%), mixed hardwoods (54%), and white pine (11%). The most common trees in Maine are shown in **Table 1.2**.

**Table 1.2: Predominant forest and species in Maine [1.1(178)]**

Forest	Distribution	Species
Northern Hardwoods *7.2 mil acres	Central Western Northern	Sugar Maple
		American Beech
		Yellow Birch
		White Birch
		Aspen
Spruce Fir *5.2 mil acres	Northern Sporadic elsewhere	Red Spruce
		White Spruce
		Black Spruce
		Balsam Fir
		White Cedar
White Pine	South	Eastern White Pine
		Red Oak

Maple/Beech/Birch is the most common forest type with 7.2 million acres followed by Spruce-Fir with 5.2 million acres. These two groups represent 72% of all timberland acreage. The most abundant commercial tree species (>5" diameter at breast height (DBH)) in descending order are: spruces, balsam fir, sugar maple/beech/birch, and red maple. 94% of merchantable size softwood trees and 86% of hardwood are saw timber grade, but only 1 out of 2.5 softwood and 1 out of 5 hardwoods are used as such [1.1(178)].

For all live trees greater than 1" DBH, the most abundant commercial species are balsam fir, red maple, sugar maple/beech/birch, spruces and intolerant hardwoods. Based on current indications and predictions, the in-growth of young trees will cross over the merchantable limit within 5-10 years allowing high confidence for the economic and environmental sustainability of the Maine woods [1.1(178)].

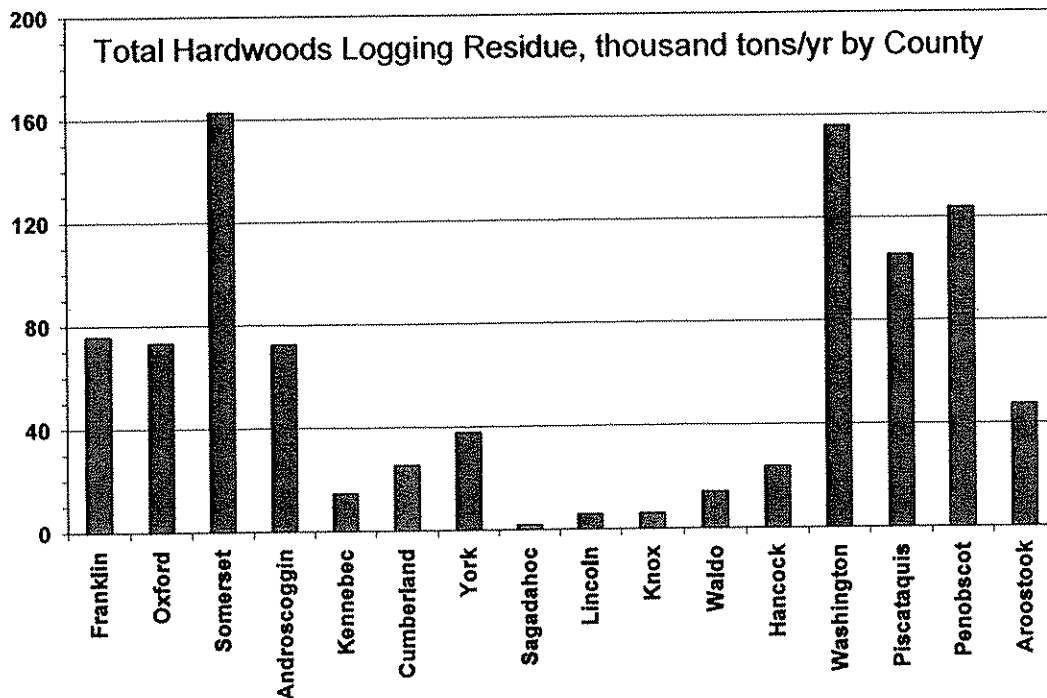
Although logs for sawmills and paper mills can be transported great distances, it is unlikely that residues can be hauled a long way, therefore it is important that target feedstock species are within close proximity (~ m 50 mile radius) to the conversion site. Furthermore, one area of **future interest** is the scenario where residues from individual species or classes of species can be isolated for target product isolation. Specific targets are the extractives component of hardwoods (e.g., phenolics) and softwoods (e.g., sterols).

1.3.1 Hardwood Residue Distribution [1.1(25)]

The hardwood logging residue by species and county [1.1(25)] are shown in **Table 1.3** and the total shown in **Figure 1.13**. The residues for Oxford and Franklin counties are high for beech, birch, and maple. The total, as shown in the summary (Section 1.0), is 450 tons hardwood residue/day.

**Table 1.3: Hardwood logging residues, thousand tons/year [1.1(25)]**

	Ash	Aspen	Beech	Yellow birch	Other birch	Hard maples	Soft maples	Red Oaks	White Oaks	Other	Total
Franklin	1.4	4.7	1.4	0.2	5.4	10.2	1.9	1.5	0.0	49.2	75.8
Oxford	0.1	3.9	1.6	2.4	1.0	0.2	1.2	0.0	0.0	63.0	73.3
Somerset	4.6	7.1	1.1	0.3	6.5	5.4	2.4	2.2	0.0	133.3	162.9
Androscoggin	0.1	28.2	0.1	0.0	0.2	1.7	4.2	0.6	0.0	37.5	72.6
Kennebec	0.4	1.7	0.0	0.0	0.4	0.2	0.2	0.7	0.0	11.0	14.6
Cumberland	0.1	0.4	0.1	0.2	0.3	0.1	0.1	0.7	0.0	23.3	25.3
York	0.1	1.4	0.0	0.3	0.0	0.1	0.1	4.8	0.0	31.1	37.9
Sagadahoc	0.0	0.4	0.0	0.0	0.0	0.0	0.0	0.3	0.0	1.1	1.8
Lincoln	0.1	1.1	0.0	0.1	0.2	0.0	0.0	0.2	0.0	4.2	5.8
Knox	0.1	1.1	0.0	0.0	0.2	0.1	0.0	0.5	0.0	4.2	6.0
Waldo	0.3	2.1	0.0	0.1	0.0	0.1	0.0	1.0	0.0	10.3	14.0
Hancock	0.2	3.8	0.1	0.1	0.5	0.2	0.1	0.1	0.0	18.7	23.8
Washington	0.2	5.1	0.0	0.1	0.4	0.3	0.3	0.0	0.0	149.5	155.8
Piscataquis	0.0	9.3	1.1	0.1	0.0	0.2	2.0	0.4	0.2	92.1	105.5
Penobscot	0.0	29.1	0.5	0.5	2.3	0.3	2.5	1.1	0.2	87.4	123.8
Aroostook	1.5	21.3	0.3	0.7	0.8	3.9	0.3	0.3	0.0	18.3	47.4
<b>Total</b>	<b>9.0</b>	<b>120.5</b>	<b>6.4</b>	<b>5.0</b>	<b>18.3</b>	<b>22.9</b>	<b>15.2</b>	<b>14.6</b>	<b>0.4</b>	<b>734.1</b>	<b>946.4</b>



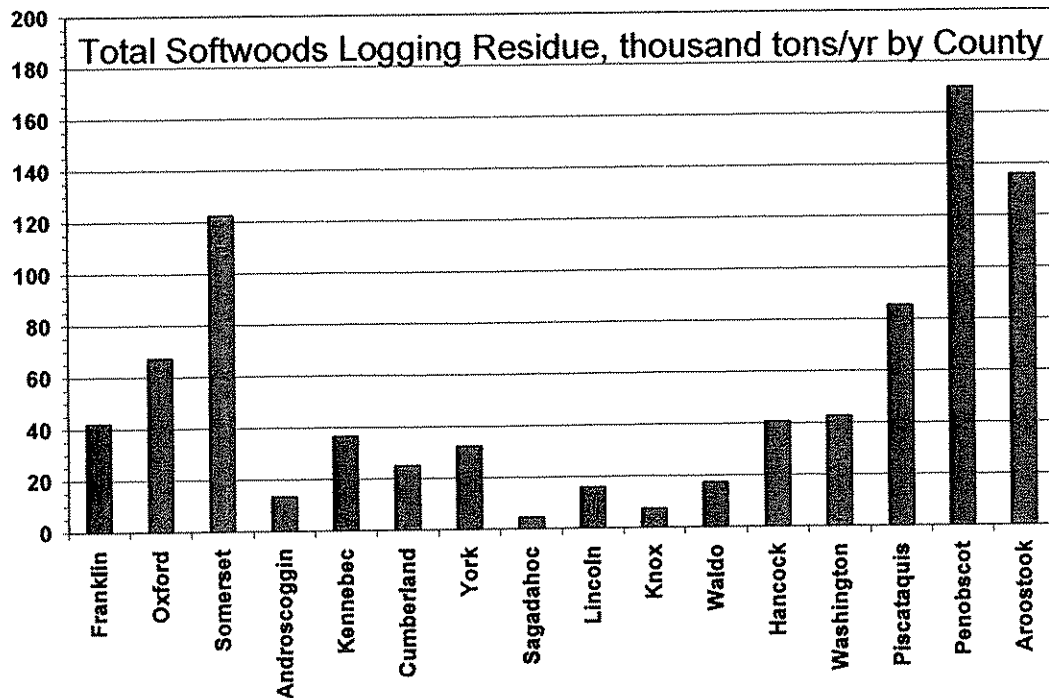
**Figure 1.13: Hardwood logging residues by county [1.1(25)]**

### 1.3.2 Softwood Residue Distribution

The softwood logging residue by species and county [1.1(25)] are shown in **Table 1.4** and the total shown in **Figure 1.14**. The residues for Oxford and Franklin counties are high for pine species. The total as shown in the summary (Section 1.0) is 325 tons softwood residue/day.

**Table 1.4:** Softwood logging residues, thousand tons/year [1.1(25)]

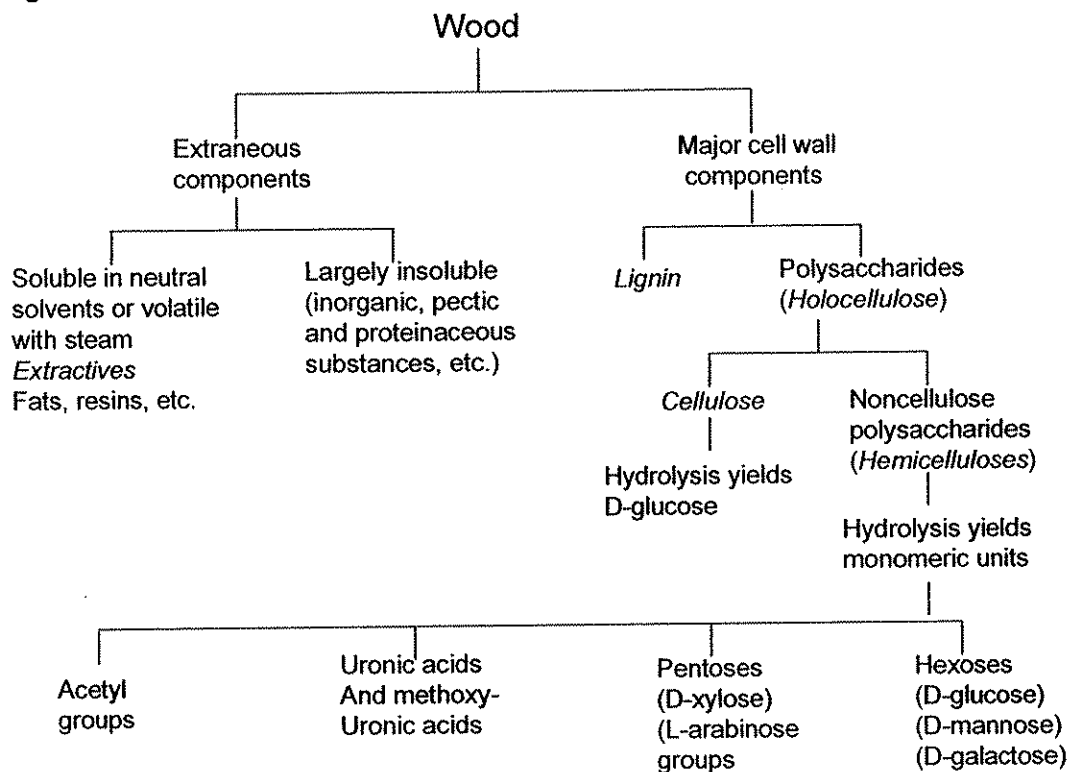
	Cedars	True firs	Hemlock	Larch	Red pine	White pine	Other pines	Spruce	Total
Franklin	0	17	3	0	0	13	1	7	42
Oxford	0	20	8	1	0	32	1	6	67
Somerset	2	75	9	1	0	12	7	17	123
Androscoggin	0	1	2	0	0	9	1	0	13
Kennebec	0	5	13	1	0	13	1	4	37
Cumberland	0	1	4	0	0	18	0	0	25
York	0	2	5	1	0	22	1	0	32
Sagadahoc	0	1	0	0	0	2	0	1	5
Lincoln	0	3	1	0	0	6	0	5	16
Knox	0	2	1	0	0	3	0	1	7
Waldo	0	3	2	0	0	8	0	3	17
Hancock	0	18	8	0	0	6	0	8	41
Washington	0	27	7	0	0	4	0	5	43
Piscataquis	2	50	9	1	0	7	0	16	85
Penobscot	3	76	46	3	0	20	2	19	170
Aroostook	7	93	17	2	0	2	0	15	136
Total	15	395	135	11	2	177	15	110	859



**Figure 1.14:** Softwood logging residues by county [1.1(25)]

## 1.4 Chemical Characteristics and Relation to New Uses

A breakdown of the major components needed to characterize wood is shown in **Figure 1.15**.



**Figure 1.15:** Breakdown of major components needed to fully characterize wood [1.2(30)]

The biopolymers of the cell wall are the defining constituents of wood. The two most important are cellulose and lignin, which are held together by the noncellulosic polysaccharides, and hemicellulose. These mixed monomer carbohydrates are hydrolyzed to the constituent monomeric sugars as shown in **Figure 1.15**.

Representative compositions for 6 hardwoods of interest are given in **Table 1.6**. The xylan content is high in these materials and potential product targets could be explored to take advantage of this. One possibility that is evaluated is the production of xylitol by a microbial process. Another distinguishing feature of hardwoods is the high acetyl content.

Representative compositions for 5 softwoods of interest are given in **Table 1.7**. The lignin content of softwoods is higher than hardwoods.

**Table 1.6: Hardwood Composition, % of wood on extractive free basis [1.2(30)]**

Species	Glucan	Mannan	Galactan	Xylan	Arabinan	Uronic Acid	Acetyl	Lignin	Ash
Beech ( <i>Fagus grandifolia</i> )	47.5	2.1	1.2	17.5	0.5	4.8	3.9	22.1	0.4
Red maple ( <i>Acer rubrum</i> )	46.6	3.5	0.6	17.3	0.5	3.5	3.8	24.0	0.2
Sugar maple ( <i>Acer saccharum</i> )	51.7	2.3	<0.1	14.8	0.8	4.4	2.9	22.7	0.3
Trembling aspen ( <i>Populus tremuloides</i> )	57.3	2.3	0.8	16.0	0.4	3.3	3.4	16.3	0.2
White birch ( <i>Betula papyrifera</i> )	44.7	1.5	0.6	24.6	0.5	4.6	4.4	18.9	0.2
Yellow birch ( <i>Betula lutea</i> )	46.7	3.6	0.9	20.1	0.6	4.2	3.3	21.3	0.3

**Table 1.7: Softwood Composition, % of wood on extractive free basis [1.2(30)]**

Species	Glucan	Mannan	Galactan	Xylan	Arabinan	Uronic Anhydride	Acetyl	Lignin	Ash
Balsam fir ( <i>Abies balsamea</i> )	46.8	12.4	1.0	4.8	0.5	3.4	1.5	29.4	0.2
Eastern white-cedar ( <i>Thuja occidentalis</i> )	45.2	8.3	1.5	7.5	1.3	4.2	1.1	30.7	0.2
Eastern hemlock ( <i>Tsuga canadensis</i> )	45.3	11.2	1.2	4.0	0.6	3.3	1.7	32.5	0.2
White spruce ( <i>Picea glauca</i> )	46.5	11.6	1.2	6.8	1.6	3.6	1.3	27.1	0.3
Tamarack ( <i>Larix laricina</i> )	46.1	13.1	2.3	4.3	1.0	2.9	1.5	28.6	0.2

## 1.5: Paper Mill Residues

The mill residues in Maine are currently utilized when economically feasible, but higher value product formation scenarios can be evaluated. This section will review tall oil, black liquor, and sludges.

### *1.5.1 Tall Oil*

The name, "Tall Oil" was derived from the Swedish word for pine oil, "talloja," and is also called naval stores since it was processed to make tar for shipbuilding. It is commonly harvested from pine trees that are cut to stimulate the production of this oleoresin that is exuded to protect the tree. The components of tall oil are discussed in **Section 3.7**. During pulping, tall oil can be separated from the black liquor where it forms a foamy soap, which forms an oil when acidified. The oil can be separated into pitch, rosin and fatty acids. The U. S. consumption of tall oil was approximately 1 million tons in 2000 and is estimated to grow at 2% annually [1.4.1(48)].

### *1.5.2 Sludge*

Up to 100 kg of combined sludge is formed per ton of pulp and paper produced. Mechanical pulp produces the least sludge while mills using recycled paper produce the most [1.4.2(13)]. Pulp mill sludge is a complex and variable mixture derived from mill wastewater. The characterization of typical examples of sludge is shown in **Table 1.9**. The major barrier for use as a fuel is the moisture content and potential contaminants, such as heavy metals and chlorinated organics, such as dioxin. Other constituents, created by bacteria in the treatment ponds, are difficult to characterize and are susceptible to public scrutiny [1.4.2 (11)].

Sludge is disposed of by landfilling, burning, or landspreading. Soil application of pulp and paper mill sludge contributes to the organic matter content that result in chemical and physical improvements to the soil. Sludge amendment may increase the water-holding capacity of soil [1.4.2(3)] and improve structural stability, especially on clay soils and may contribute to an increase in the cation exchange capacity of the soil [1.4.2(15)].



**Table 1.9: Chemical Characterization of Paper Mill Sludge (%) [1.4.2(23)]**

Source	Solids	Ash	C	H	A	O	N	Heating value MJ/kg
Bleached pulp mill	33.4	1.9	48.7	6.6	0.2	42.4	0.2	20.1
Pulp mill	42.0	4.9	51.6	5.7	0.9	29.3	0.9	21.5
Kraft mill	37.6	7.1	55.2	6.4	1.0	26.0	4.4	24.1
Kraft mill	40.0	8.0	48.0	5.7	0.8	36.3	1.2	19.8
Bark	54.0	3.5	48.0	6.0	0.1	42.1	0.3	20.3

### 1.5.3. Black Liquor

The U.S. Pulp and Paper Industry produces and uses approximately 1.6 quads of biomass energy. The black liquor contains about 50% of energy of the wood fed to a kraft pulp mill, which is recovered in Tomlinson recovery boilers to generate steam and recover the pulping chemicals for reuse. Seven hundred boilers worldwide process two hundred million tons of black liquor annually using conventional combustion systems [1.4.4(26)].

Black liquor gasification combined cycle (BLGCC) has been a focus of the industry to reduce the capital intensiveness of the paper industry and increase energy efficiency. The use of BLGCC for replacement of old recovery boilers, can potentially double power production and lead to an increase in pulping capacity. Three BLGCC designs were developed incorporating different gasification technologies and design philosophies [1.1(178)]. Paper companies using black liquor gasification are Georgia Pacific, Big Island (BL Steam Reforming project at GP's Big Island), Virginia Facility, IP, Norampac, Sappi, and Weyerhaeuser. ThermoChem Recovery International, Canada, is one of several companies scaling up gasification technology for energy recovery based on their PulseEnhance™ steam reforming system. Their plant in Trenton, Ontario is designed to process 111 tons/day of black liquor solids [1.4.4(6)].

Chemrec of Stockholm, Sweden has developed black liquor gasification technology for increased recovery capacity and flexibility in chemical recovery using low pressure, air-blown gasification. They have installed units in the range of 75-350 tons/day. Practical physical limitations on reactor size restrict unit size to 500 tons/day. Technology based on oxygen-blown gasification at high pressure will have several advantages. The high pressure and lack of nitrogen dilution result in higher black liquor throughput, lowering capital costs. The Chemrec system also plans for the potential coproduction of transportation fuels such as methanol, dimethyl ether, and hydrogen, which will require additional gas conditioning and catalytic synthesis steps [1.4.4(8); 1.4.4(10); 1.4.4(16)].

#### 1.5.4 Bark

Bark is a byproduct from all classes of feedstocks shown in **Figure 1.1**. The composition of bark compared to wood is shown in **Table 1.10**.

**Table 1.10:** The approximate composition of ash free wood and bark, wt % [1.4.5(5)]

	Softwoods		Hardwoods	
	Wood	Bark	Wood	Bark
Lignin*	25-30	40-55	18-25	40-50
Polysaccharides*	66-72	30-48	74-80	32-45
Extractives	2-9	2-25	2-5	5-10
Ash*	0.2-0.6	Up to 20	0.2-0.6	Up to 20

\*Based on extractive-free material.

Typical barks contain significantly more lignin, extractives, ash, and lower amounts of carbohydrates. The yield of bark is shown in **Table 1.11**.

**Table 1.11:** Typical bark volumes as a function of species and age [1.4.5(5)]

Wood	Diameter of Tree	Number of Growth Rings	Bark Volume Based on Wet Log Volume
	Inches		Percent
Spruce	4.2	62	12.06
	8.7	112	9.26
Fir (true)	4.5	38	10.0
	8.4	65	9.4
Birch, white	3.9	46	14.5
	8.3	68	9.5
Birch, yellow	4.2	74	10.1
	9.3	92	9.3
Beech	4.2	63	6.9
	8.9	125	6.1
Maple, sugar	4.1	67	13.5
Average	7.8	114	18.0

## 1.6 Municipal Solid Waste

**Table 1.12: Municipal Solid Waste Biomass Plants [1.4.3 (15)<sup>1</sup>, 1.4.3(25)<sup>2</sup>]**

LOCATION <sup>1</sup>	Plant Name <sup>1</sup>	CAPACITY (MW) <sup>1</sup>	Tons Combusted <sup>2</sup>	% of Maine's Population Served <sup>2</sup>
Portland	Regional Waste Systems Inc	13.3	75,707.67	19
Biddeford	Maine Energy Recovery Co.	22.0	90,075.67	14
Auburn	Mid-Maine Waste Action Corp	5.0	53,732.06	11
Orrington	Penobscot Energy Recovery Co.	25.3	177,758.42	25

**Table 1.13: Maine Solid Waste and Recycling Tonnage, 2003 [1.4.3(49)]**

Material	Total
Fibers	277,000
Containers	55,805
Organics	82,076
Metals	161,219
Other Recyclables	141,483
All Materials Reported Recycled	717,583
MSW Disposed in State	1,145,421

### 1.6.1 Construction and Demolition Wood (CDW)

Boralex Inc, a Canadian owned and operated firm, is the largest producer of electrical energy from wood residues in North America. They own and operate seven wood combustion plants, 5 in Maine, ranging from 16 to 50 MW for a total 232 MW installed capacity. Construction & demolition wood (CDW) is a cost effective fuel source with minimal environmental impact when state of the art combustion practices are used to minimize air emissions. CDW can be 10% of the feed, or 300,000 tons/year. Only Livermore Falls and Athens plants are currently allowed to burn CDW. EPA requires tests of air emissions from stacks that must fall within a range that limits CDW to 10% of feed.

Ash from biomass plants is typically land spread. However, if using CDW, more ash is created that must go to a landfill, which is more expensive. Poor quality feed material can result in up to 10% ash rather than 4% with clean recycled wood. Treated wood such as railroad ties or telephone poles is accepted, but chromated copper arsenate treated wood has the potential to create dioxin emissions and unacceptable ash [1.4.6(4)]

Boralex Stratton Energy (BSE) requested a change to include CDW at a feed rate up to 75% by weight of annual fuel use and daily feed rate. For this license, the CDW must be chipped wood demolition debris (including pallets) with minimal painted, chemically treated wood, asphalt roofing and other nonwood related demolition products. The percent plastic and/or chlorine content limit is to be determined by obtaining samples every 2 weeks and analyzing for % by wt plastics and total chlorine content of plastics.

BSE performed trial burns and stack testing while firing up to 75% CDW to evaluate if any changes in emission rates would occur and found that lead emissions would increase slightly, but remain below the 0.6 tons/year threshold for lead. Total Allowable Annual Emissions for the Facility is used to calculate the annual license fee [1.4(41)]. **Table 1.14** shows the allowable limits.

**Table 1.14:** Allowable limits for wood combustion plants [1.4(41)]

Pollutant	TPY
PM	97.4
PM <sub>10</sub>	97.4
SO <sub>2</sub>	101.4
NO <sub>x</sub>	930.3
CO	1777.6
VOC	206.9
Lead	0.35

The EPA estimates that 130 M tons of CDW is generated yearly. In 1995, the Environmental Resource Return Corp (EERCO) CDW processing plant in Epping, NH utilized an extensive processing system that included multiple picking stations, shredders, flotation tanks and screens. The EERCO system processed 600 tons/day in a 2-shift operation and has processed 1 million tons C&D debris into marketable end products. The feedstock is demolition-based debris, delivered in 100-yard trailers from sites throughout New England and construction or renovation-based material normally delivered from sites within a 30-mile radius of the plant. From a processing standpoint, the construction-based material generates considerably more residuals than demolition debris and influences operation costs and processing time.

To be successful, a CDW processing facility must operate as a manufacturing plant creating products that must satisfy competitive market competitions. Processing CDW as a business requires reliable markets for derived products, and tipping fees and product sales revenue are a function of competing alternatives for processing services and derived products. Companies need to charge its service customers a low enough tipping fee to attract material [1.4.6(6)].

### 1.6.2 Waste Paper

The waste paper industry is recovering 48% of all paper consumed in the US with a target of 55% by 2012 [1.4.7(16)]. Cascades Inc., Montreal, has acquired a de-inked pulp mill located in Auburn, Maine. The mill has an annual capacity of 75,000 metric tons and cost \$70 million to construct in 1995. With this acquisition, the Cascades Group now has nine de-inking units producing more than 375,000 metric tons of de-inked pulp annually [1.4.7(18)].

Materials Recovery Facilities (MRF) are moving towards private ownership and increasingly using automatic separation equipment where feasible. One new technology is separating corrugated cardboard from mixed paper. Some paper recyclers are stepping up their acquisition of both MFRs and paper processing facilities [1.4.7 (12)].

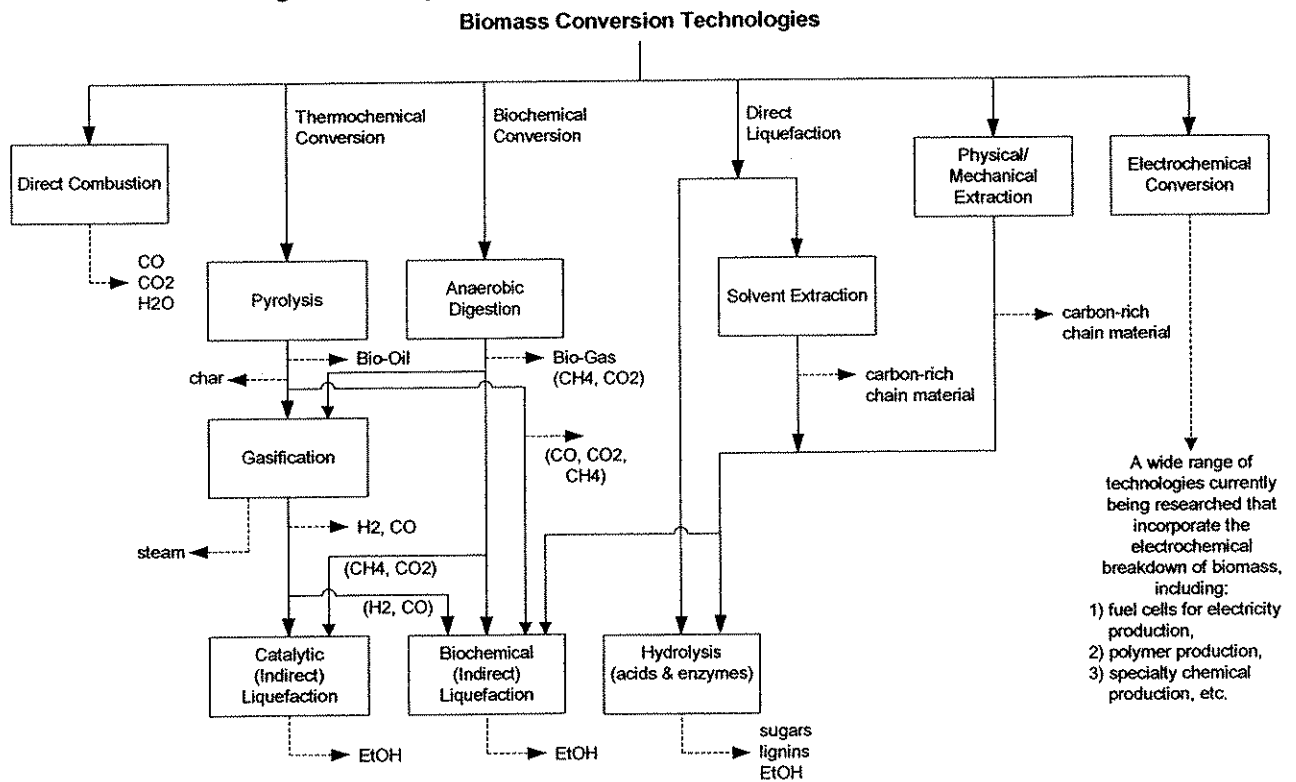
Weyerhaeuser is acquiring facilities that handle glass plastic and aluminum. The company makes the nonpaper available to others and remanufactures the paper. The Weyerhaeuser system uses manual sorting methods, but is interested in high-tech systems as well as acquiring paper recycling facilities [1.4.7(6)].

WMX Technologies of Oak Brook IL own and operate 160 MFRs throughout the US (acquired Resource Recycling Technologies and CRI Inc); RRT was a pioneer in automating the MFRs. At its facilities, 75 to 80% of materials in a commingled container stream are not physically touched. Philadelphia Paper Plant is the highest-tech paper facility in the country [xxxx].

The Bowater facility in Maine has a plastic-tolerant system for de-inking newsprint called Maine Pack. The plant takes in newspaper, junk mail, magazines, and phone books to produce brown paper and chip board [xxxx].

## 2.0 Assessment of Conversion Technology Options and Challenges

For the past several decades a wide range of conversion pathways have been researched, and many have been used throughout the world in commercial or industrial applications, but generally at a limited production level for local or regional product supply purposes. Recent advances in biomass conversion technologies support a re-evaluation of energy-from-biomass technologies, include the ability to operate select processes more efficiently (and thus more economically) and realize improved yields of products from traditional biomass processes. New process configurations also lend themselves to improved product yields. The changing economic picture of fossil fuels, particularly with petroleum, is probably the greatest driving factor in renewed interest in biomass technologies. **Figure 2.1** shows a reasonably comprehensive view of biomass conversion technologies leading to desired products [Appendix 1].



**Figure 2.1:** Global view of biomass conversion options [Appendix 1]

To date, the most commonly used technologies for processing biomass are:

- Combustion for traditional cooking and heating
- Combustion for power generation (typically 5-50 MWe using steam turbines)
  - Anaerobic digestion as a waste reduction technology, with some applications recovering the produced  $\text{CH}_4$

- Combined pyrolysis/gasification for production of steam for electricity and secondarily for the production of fuel.

The pyrolysis and gasification approach to using biomass is not employed widely at a commercial, industrial, or community level, but is expected to realize significant growth in the coming years.

The following conversion options are assessed (numbers refer to database designation):

#### 2.1 Pyrolysis

- 2.1.1 Separation
- 2.1.2 Reforming
- 2.1.3 Acetalization
- 2.1.4 Activation
- 2.1.5 Densification
- 2.1.6 Adsorption

#### 2.2 Gasification

- 2.2.1 Conditioning
- 2.2.2 Catalytic Synthesis
- 2.2.3 Reforming
- 2.2.4 Bioconversion
- 2.2.5 Combustion

#### 2.3 Fractionation

- 2.3.1 Bioconversion
- 2.3.2 Acid Catalysis
- 2.3.3 Hydrogenation
- 2.3.4 Esterification

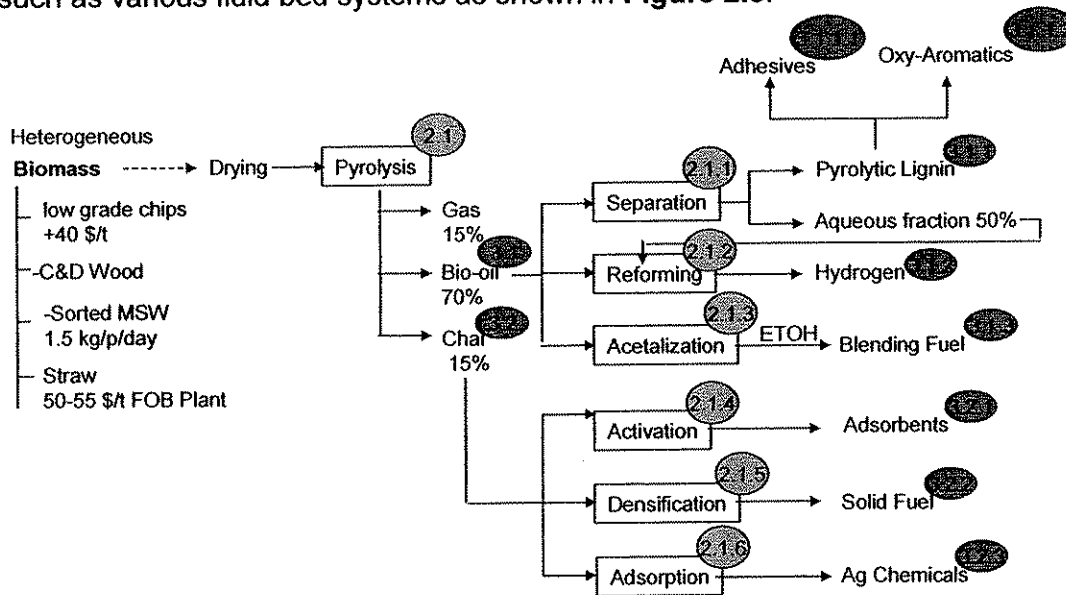
The major long-term feedstock is the low-grade biomass comprised of forest residues. This stream can be subdivided into two grades. Fractionation processes require more homogeneous feedstock since reaction severity must be optimally set depending on the nature of the feedstock. The more heterogeneous feedstock can be used by thermochemical conversion, which includes combustion, gasification, and pyrolysis. The homogeneous stream can be used wet, but the thermochemical processes require drying. As discussed in the Summary, the best opportunities will be a combination of fractionation and thermochemical processes, since the thermochemical operations can provide process heat and the integrated operation can obtain high energy efficiency and process a wide range of potential feedstocks. Much can be modeled on the world class paper mills in the western Maine region.

## 2.1 Pyrolysis

Pyrolysis technology is of primary interest because of the possibility of distributed production and integration with hydrogen production. Bio-oil to hydrogen is considered a near term renewable hydrogen production option and is possible to be the basis for technology demonstration beyond the current projects which are emphasizing hydrogen dispensation infrastructure and the initial use of fuel cell vehicles. The pyrolysis pathway produces a variety of products as shown in **Figure 2.2**.

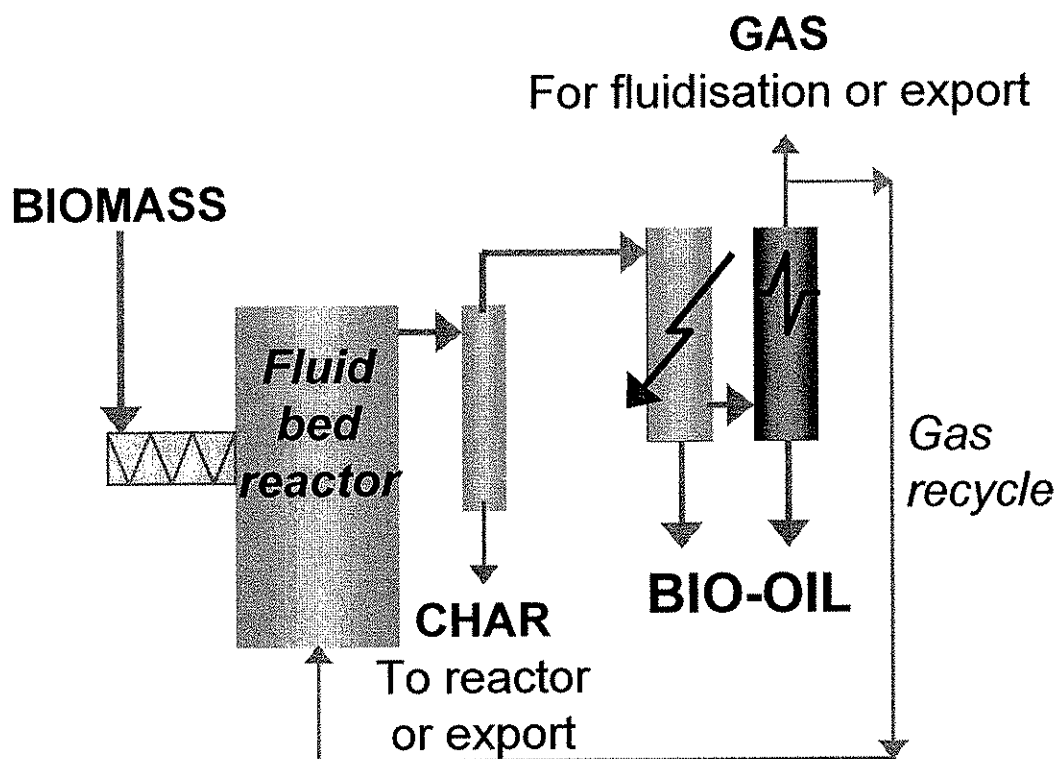
Pyrolysis is considered amenable to heterogeneous feedstock. The pyrolysis products of interest are char and bio-oil, the condensable organic products that also includes approximately 15 wt. % water, produced within the reaction.

Pyrolysis has been practiced for years for charcoal production but in the 1970s interest in new technology that minimized the production of charcoal and maximized the production of bio-oil began to be studied. Often called fast pyrolysis since they rely on reactor systems where high heat transfer is possible such as various fluid bed systems as shown in **Figure 2.3**.



**Figure 2.2:** Biomass pyrolysis conversion pathways and potential target products





**Figure 2.3:** Typical fast pyrolysis system based on fluid bed technology [2.1(21)]

The bio-oil produced in slow pyrolysis phase separates to a tar fraction and an aqueous fraction that was historically called pyrolignous acid. In fast pyrolysis where the water content is below 20% a single phase exists, but by adding water the material can be separated along these historical lines

### 2.1.1 Bio-Oil Separation

Pyrolysis was the basis of the chemical industry until 1890 when coal tar replaced it as the source of functional chemical streams. The production of methanol and acetic acid were the feedstock for a variety of isolated chemicals. Likewise, the tar fraction was used for the production of a limited variety of products such as wood preservatives, but in low yields. In progress since the early seventies separation of bio-oil to characterize fractions base on solubility in solvents was attempted to enable a simple analytical procedure to effectively characterize this complex material.

In 1988, scientists at NREL successfully developed a separation scheme base on ethylacetate solubility to separate a phenolic fraction used as a replacement for phenol in phenol formaldehyde thermosets. Successful materials were developed for both the Novalac and Resole resin types. Novalacs are the Bakerlite type plastics used in high thermal stability rigid products such as pot

handles. In the final product, wood odor problems were encountered. Resoles are the adhesives used in wood laminates and represent a much bigger market. Odor in the final product was not as critical due to different processing conditions.

**Radlein and Piskorz** [2.1.1(14)] developed a simpler water-soluble fractionation scheme that effectively separated the phenolic fraction. This work was also applied to the adhesive feedstock opportunity as currently practiced by Ensyn.

With regards to the aqueous fraction, work by Radlein and Piskorz [2.1.1(14)] showed that hydroxyacetaldehyde was a major product of cellulose pyrolysis. In a process developed by Ensyn, Red Arrow has been using a fast pyrolysis process for several years to produce hydroxyacetaldehyde, which has a high value application as a food additive for meat products. Although this is a limited market, it demonstrates the possibility of using simple separation schemes to get cuts that can be used in industrial applications

### *2.1.2 Bio-Oil Reforming*

In the mid 90's, scientists at NREL developed a co-product strategy where the production of adhesives from phenolic fraction could be combined with the production of hydrogen from the aqueous fraction. Hydrogen produced from biomass was predicted to be competitive with natural gas. Conventional technology for natural gas could not be used because as the bio-oil is vaporized and heated to the reaction temperature of 850 °C, thermal reactions form carbon deposits in a packed catalyst bed. A catalytic fluidized bed reactor was developed and successfully demonstrated at the bench scale with the aqueous fraction as the feedstock.

This work was extended to the whole vapor in a project in Georgia where activated carbon from peanut shells was the co-product. The direct coupling of the pyrolysis unit with the reformer made the re-volatilization of the bio-oil unnecessary and the unit successfully operated at a larger scale of 25 kg-H<sub>2</sub>/day for approximately 100 hours, although problems were encountered with the pyrolysis unit. That work continues with a 1000-hour demonstration at the University of Georgia.

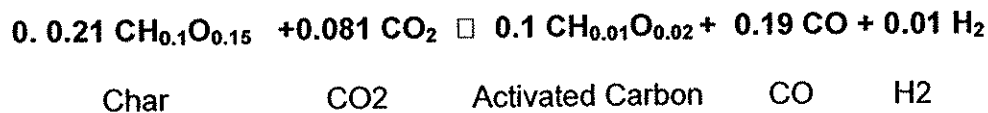
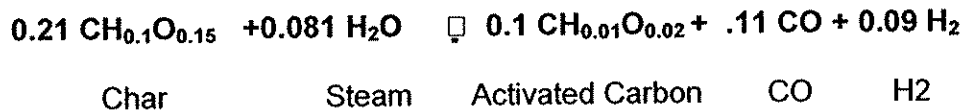
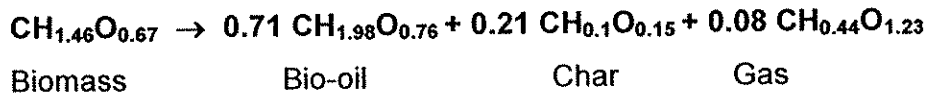
The main current interest of the DOE hydrogen program is to develop and demonstrate bio-oil as a renewable source of hydrogen for distributed generation. Distributed generation of hydrogen at the point of dispensation is important to avoid transportation costs. Current DOE work features the distributed reforming of ethanol, sugar derivatives and bio-oil. Of these, bio-oil is the most cost effective but presents challenges for automated small-scale systems. NREL continues work on this process [2.1.2(14)].

### 2.1.3 Acetalization

The pyrolysis of wood is largely a depolymerization process that leads to low molecular weight products that are reactive, which leads to problems with condensation product formation when the bio-oil is volatilized through reheating. To overcome this phenomenon, the end groups of these compounds can be capped with an alcohol such as ethanol or methanol. Forming the methyl or ethyl ester of an acid lowers the boiling point as is observed with biodiesel, which are methyl esters of fatty acids, which makes them more volatile and stable as diesel fuels. Alcohols can also form ethers by this process. Radlein, et al [2.1.3(6)] filed a European patent application on the process as a method of upgrading bio-oil for use as fuels and as a source of chemicals. Little has been published on this concept but it remains a viable alternative to utilize renewable methanol and ethanol to upgrade bio-oil increasing its value as a fuel by increased stability and higher heat content.

### 2.1.4 Activation

The bio-carbon product of pyrolysis upgrades can be upgraded by activation with steam or CO<sub>2</sub>:



This activated product can serve as an adsorbent for water and air clean up, which can be an attractive option for product integration into local environmental service industries. The conditions for activation are complementary to gasification and therefore present an opportunity for heat integration.

### 2.1.5 Densification

The fundamental challenges related to the use of biomass for most energy conversion are: moisture content, oxygen content, fibrous nature, heterogeneous physical form, low bulk density, low energy density, and variation in physical and chemical form, including inorganics. The best technical approach to these

challenges is densification technology. The idea of combining the use of charcoal with densified sawdust would also increase the energy density of the product. Pellets are a growing market in Europe and allow automated operation of small-scale heating devices. Pelletization adds about \$20/dry ton. Another suggested step is torrefaction of the wood where mild pyrolysis is used to decrease the oxygen content of the biomass from 40 to 30%, which will increase the energy density. Tom Reed of the Biomass Energy Foundation [2.1.5 (8)] has proposed combining densification and torrefaction to take advantage of the plastic nature of the wood at the torrefaction temperature and further increases the energy density of the product as well as the energy requirements for pelletization. Bio-Carbon can be added to the wood feed prior to pelletization to further increase the energy density of biomass.

### *2.1.6 Adsorption*

The activated carbon produced by pyrolysis can be used as carriers of agricultural chemicals such as pesticides and fertilizers. This may have applications in high value markets such as golf courses where agricultural chemicals are often deployed in near natural water systems.

### *2.1.7 Case Descriptions*

Flowsheets for three illustrative cases for pyrolysis conversion options are shown in **Figures 2.4-2.6**. The basic steps of the pyrolysis process to produce gases, liquids and solids include:

- Biomass Preparation (sizing, drying)
- Biomass Feed to Pyrolyzer
- Pyrolyzer (w/ ancillary feed heater, steam supply)
- Gas/Solids Separation
- Recycle loop
- Bio-Oil Condenser
- Gas, Liquid and Solid product streams (some maybe used as fuels)

The inclusion of any recycling loop needs to be approached with care. This seemingly simple flow chart process option has a large impact on process complexity and equipment costs (capital and maintenance). The economics of conversions, yields and efficiencies will determine if recycle is necessary and appropriate.

In these diagrams, the main conversion process is from left to right across the sheet. The process components depicted in the lower right section of the drawings suggest secondary step processing to the primary biomass conversion products. Depending on operating conditions, the gas / liquid / solids

compositions and ratios can change drastically. The choice of operating conditions will depend on what is to be done with the G/L/S streams produced.

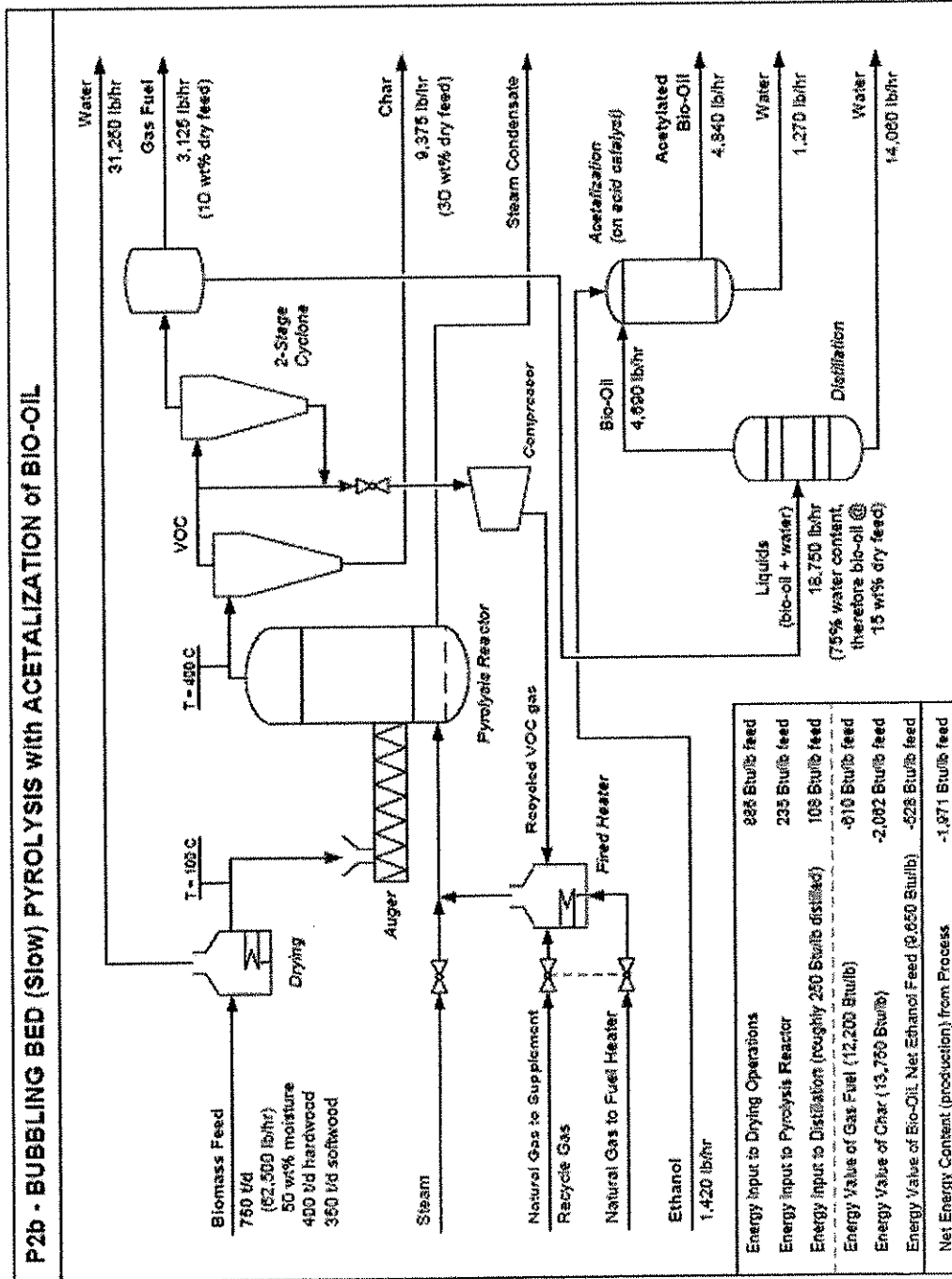
For example and as depicted in diagram P2a, at *higher* temperature and *shorter* residence time, pyrolysis will yield some gas (non-condensables), some char solids and a relatively large amount of condensable bio-oils mixed with water. The bio-oils could then be transported to a centralized facility for further transformation or processed on site if economical. The example depicted in diagram P2a suggests the transformation into liquid fuels. We are all familiar with the other options for processing bio-oils and separating the water soluble and insoluble components as proposed by the NREL work of recent years for the production of hydrogen and phenolic compounds.

At *lower* temperature and *longer* residence time, pyrolysis results in a change in ratio of G/L/S towards more gases, more char, and less bio-oils but more water. In this case, more of the required process energy is provided by the biomass in process.

The liquid bio-oils offer a means of increasing the energy density and facilitating the transport of a different form of raw product. Solid chars produced may find their way back into the process as fuel or may serve as a means of "encapsulating" otherwise toxic ash residues for easier disposal. Depending on quantities and quality of the syngas stream, it can be used as fuel for power or steam generation or transformed further into a short list of desirable products.







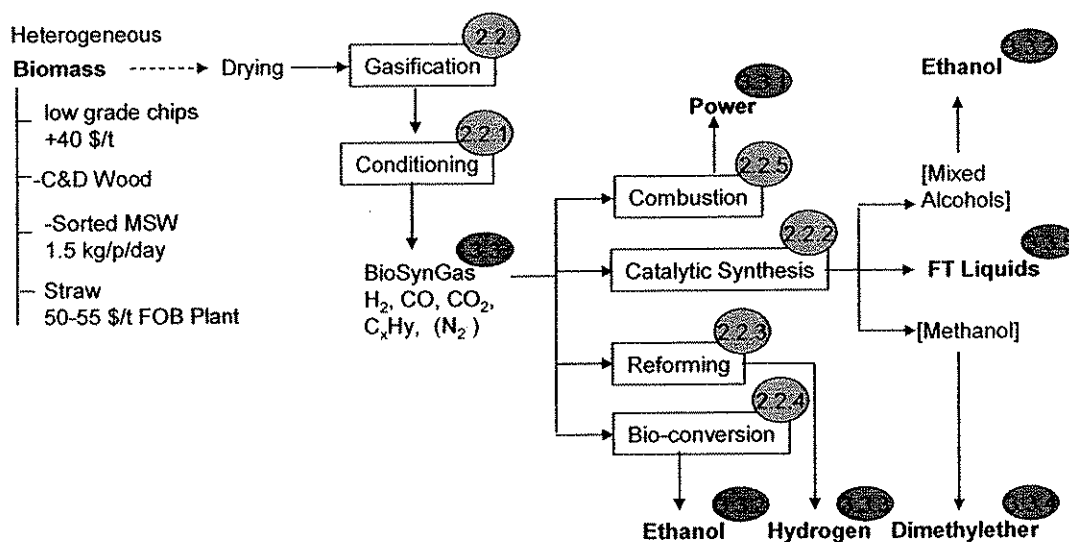
© 2005 Henson Technologies

**Figure 2.6: Mass and Energy Balances for Case P2b – Slow Pyrolysis Bio-oil Acetalization**



## 2.2 Gasification

For many years proponents/researchers have promoted the gasification of biomass for heat, power and indirect synthesis of liquid fuels. By far, the most successful gasification systems are those targeted for heat production. This can often get around the problems of low energy content of the gas and gas quality and the gas can be used as a secondary fuel for existing conventional fossil fuel systems. Gasification for power has focused on the opportunity to use integrated gasification and combined cycle power generation which promises to raise the overall efficiency from the low 20's to approximately 40%. When combined with heat generation, the overall efficiency can approach 80%. Proponents of advanced gasification system extend this concept to tri-generation where fuel synthesis is integrated with heat and power, either by single pass over a catalyst system or by using the excess gas during off peak power demand times to make a storable fuel such as methanol. The challenges for biomass gasification have been both technical and financial, and no demonstration has successfully shown tri-generation to date. In Värnamo, Sweden, the gasification pilot plant successfully demonstrated the technical feasibility of integrated biomass gasification combined cycle (IBGCC) [2.2(8)]. **Figure 2.7** shows the overview of gasification conversion.



**Figure 2.7:** Biomass gasification conversion pathway and potential target products

### 2.2.1 Syngas Background

Syngas use in the synthesis of hydrocarbons has been known for a little less than a century. Many of the conversion processes were developed in Germany during wartime when natural resources were scarce and alternative routes to

hydrogen, ammonia and fuels was a necessity [xxxx]. The political situation of South Africa in the second half of the 20<sup>th</sup> century and the abundance of coal reserves helped establish a successful Fischer Tropsch synthesis (FTS) industry in that country while the rest of the world was focused on petroleum derived fuels and chemicals. Poor economics were of little concern in either of these cases [2.2.7(16)].

Increasing environmental concerns and tighter markets from conventional fossil fuels is reviving interest in syngas conversion technologies to produce cleaner fuels and chemicals. Recent events and increasing prices for natural gas and petroleum may prove to be sufficient incentive to revisit economic and feasibility studies on the use of syngas in the production of fuels and chemicals. Syngas production from biomass may also show economic viability under these revised circumstances.

The most important parameter in the composition of syngas is the H<sub>2</sub>:CO ratio, which is a function of the process and of the feedstock. This composition ratio also impacts the choice and the outcome of the synthesis process selected to make efficient use of the syngas. All syngas conversion processes are exothermic and necessitate critical heat removal to control and optimize reaction products. Re-use of this thermal energy is essential to process efficiency and economics. Several studies suggest and recent proposed plant designs incorporate the use of generated thermal energy for the co-generation of electrical power [REF for studies]. All syngas conversion processes are catalytic and as such, imply a greater degree of complexity, added costs, more demanding control schemes and the unavoidable issues of catalyst poisons and deactivation. Fundamental improvements to the overall operations and conversion of biomass to useful fuels and chemical still need the interest and effort at the research level. The technology is sufficiently mature to support demonstration and pilot scale operations and investments, which in turn will benefit from focused development efforts to optimize the specific operating conditions of a defined process.

The commercial route to syngas-derived products, such as ammonia, is from natural gas. The transformation of natural gas to syngas accounts for about 50% of the capital cost of the entire plant. These costs increase to as much as 75% as the fuel to produce the syngas goes from gases to liquids to solids. Improving the economics of such an operation can only be achieved by lowering capital costs associated with the production of syngas and/or improving the thermal efficiency of the process. With the exception of mixed alcohols, commercial scale demonstrations of syngas transformation have been done for all the target products.

The status of biomass gasifier processes varies from R&D stages to commercial manufacturers and licensors. The Spath and Dayton study [3.3(16)] proposes

hydrogen and methanol as the two biomass-derived products with the best economical potential.

Much interest in gasification of biomass is evidenced by the extent of published technical literature and reported ventures and investments. For instance and of interest to our considered use of wood as feedstock, significant improvement to gasification operations is suggested in the work of Asadullah et al [2.2(56)], reporting the use of fluid bed, catalytic biomass gasification of wood at low temperatures of 823-973 K with Rh containing catalyst, 95% carbon conversion, little coke and no tars produced.

### *2.2.2 Gas Conditioning*

The major challenge in biomass gasification is gas conditioning. Much work has been done over the last twenty years in catalytic tar cracking as an alternative to the wet scrubbing of the raw product gas. Six challenges must be met:

1. Preservation of the heat content of the gas
2. Removal or destruction of condensable organics, "tar"
3. Adjustment of the H<sub>2</sub>/CO ratio
4. Methane conversion
5. Removal of other trace gases, such as HCL and NH<sub>3</sub>
6. Compression of the gas to the required pressure of the next conversion stage.

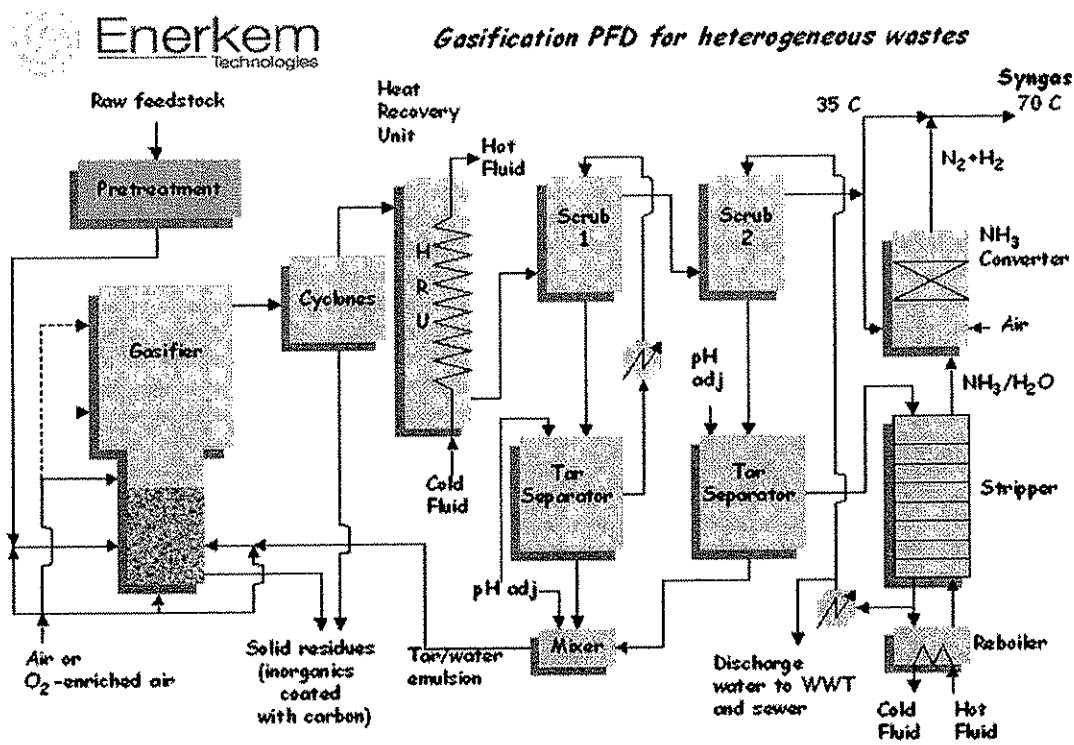
The process flow sheet used by Enerkem Technologies for their air blown gasifier is shown in **Figure 2.8**.

### *2.2.3 Reforming*

Production of hydrogen by reforming of biomass pyrolysis products was discussed in section 2.1.2 and this same catalyst system can be used for the clean up and shift of the synthesis gas to hydrogen. This hydrogen can be use for hydrogenation for upgrading of products derived from fractionation [REF].

Steam reforming of methane is usually accomplished on a NiO catalyst supported on a refractory. Variations in catalyst compositions are common and apply to active metals, modifiers, and support components. Reforming is a well-established process throughout the petroleum industry. To improve the yields in hydrogen further, the steam reforming effluent stream can be subjected to two more steps of conversion. Indeed, the water gas shift reaction can be carried out at high temperature and then at low temperature to maximize the hydrogen content. The HTS is usually done on a Fe & Cr oxide catalyst while the LTS reaction occurs on a Cu & Zn oxide catalyst. These processes are well known,

been in practice for a long time and much process design information is readily available.



**Figure 2.8:** Typical wet scrubbing system as used in the Enerkem fluid bed system [2.2 (18)]

We should draw attention to catalyst contamination and possible poisons that may be in the feedstock. Sulfur is a primary poison for all of the catalysts introduced above. HTS catalysts are usually more resistant to sulfur but still performance will be affected. The LTS catalysts are sensitive to S and to Cl. Other compounds and elements such as P, Si, unsaturated hydrocarbons and  $\text{NO}_x$  can also act as poisons and contaminants. Finally, since  $\text{H}_2$  purification operations are typically carried out on solid adsorbents, water and condensable HCs must be removed to protect the adsorbent(s).

The production of hydrogen also implies the production of large amounts of  $\text{CO}_2$ . The \$ value of hydrogen is difficult to define since plant gate prices can be significantly different from the delivered price. From the reviewed studies [REF], (circa 2003), the plant gate price of  $\text{H}_2$  for various feedstocks is as follows: Natural Gas: \$ 5-8/GJ; Coal: \$ 10-2-/GJ; biomass: \$ 7-21/GJ.

### ***H<sub>2</sub> Recap*** ***Facts***

- Largest use of syngas

- Predominantly made from methane via SMR

#### *Advantages*

- May be the most cost competitive option for biomass
- Automakers developing H<sub>2</sub> fueled vehicles
- H<sub>2</sub> is a clean fuel itself
- Concentrated CO<sub>2</sub> stream
- Mature technology
- High yields

#### *Disadvantages*

- Delivered price can be significantly greater than plant gate price
- H<sub>2</sub> economy still in the distant future

#### *Catalysts & Poisons*

- Ni catalyst
- 850°C, 15-30 bars
- syngas and H<sub>2</sub> product
- S < 0.5 ppm for reformer catalyst longevity

### *2.2.4 Ammonia Synthesis*

Parent [Appendix B] and Spath & Dayton [3.3(16)] have reviewed catalytic synthesis. Ammonia is the second largest synthetic chemical product and most of the production goes to the manufacture of fertilizers. Ammonia can also be used in the production of organic chemical feedstock for the plastics industry and for the manufacture of explosives. NH<sub>3</sub> synthesis requires pure H<sub>2</sub> and N<sub>2</sub> gas streams, free of catalyst poisons and contaminants. The reaction over a Fe-promoted catalyst is highly exothermic. The process is complex but well known and the optimization challenges that remain are the efficient removal of the heat of reaction and the control of process temperature. Improved economics, based on the reduction of process energy consumption, fuel the ongoing search for improved catalysts and process optimization. With a per-pass conversion of only 10-35%, the ammonia converter must be operated as a large recirculation loop. The complexity of such a system is further increased by the needs to purge inert and non-condensable gases continuously and to recover from the purge stream unused reactants and products to be returned to the process.

Today's commercial catalyst is essentially the same as the original one developed in the early 1900s. Magnetite is used as the source of Fe and a variety of metal oxides are used as promoters to develop and preserve the desired porosity and surface area. The Fe based catalysts are sensitive to a variety of components. Reversible contaminants or temporary poisons are CO, CO<sub>2</sub>, H<sub>2</sub>O, and O<sub>2</sub>. On the other hand, S, Cl, P, As, and Sb are irreversible poisons. Reduction of these contaminants requires extensive purification of H<sub>2</sub>

and  $N_2$  gas feeds and careful control of the catalyst manufacturing process to minimize the impurities in the magnetite ore and other oxides.

The manufacturing price of ammonia is very dependent on the price of the feedstock. For the past 20 years, the price of  $NH_3$  produced from natural gas has varied between \$100-250/ton.

### ***NH<sub>3</sub> Recap***

#### *Facts*

- Largest consumer of  $H_2$
- Second largest synthetic chemical product

#### *Advantages*

- Mature technology
- Many commercial plants worldwide
- Natural gas is most favored feedstock but still many plants using coal

#### *Disadvantages*

- Toxic

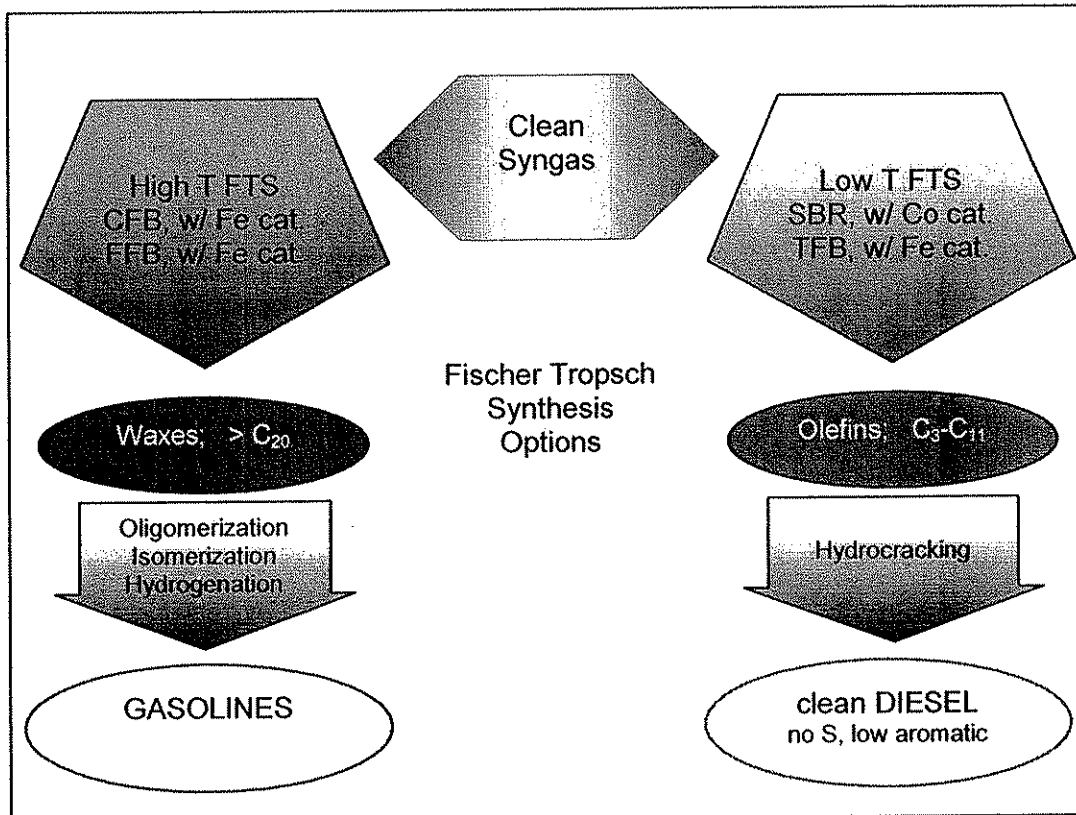
#### *Catalysts & Poisons*

- Fe, FeO w/ additives
- 430-480°C, max 550°C
- 100-500 bars
- $H_2:N_2 = 2-3:1$
- Ammonia product, 10-35% conversion / pass, selectivity > 99% w/ recycle
- Reversible catalyst contaminants:  $H_2O$ , CO,  $CO_2$ ,  $O_2$
- Irreversible catalyst poisons: S ( $H_2S$ ), Cl, As, P, Sb

### *2.2.5 Fischer Tropsch Synthesis*

The manufacture of liquid hydrocarbons from gases over Fe catalyst by the Fischer Tropsch synthesis route goes back to 1923. Much work has gone into catalyst and process development ever since. The term FTS is used for most conversion processes transforming CO and  $H_2$  mixtures into liquid hydrocarbons over transition metal catalysts.

FTS plants went online in Germany in 1938 and stopped production after the war. South Africa has been a world leader in liquid fuels and chemicals from coal and crude oil using FTS since 1955. A few other countries have recently (mid-90s) entered the market namely Malaysia, New Zealand and Australia. Several others are in the process of establishing FTS capabilities and coal or natural gas is the principal feedstock today [2.2.7(16)]. The generic FTS pathways are shown in **Figure 2.9**.



**Figure 2.9:** Generic Fischer Tropsch Synthesis Process Flow Diagram  
[Appendix B]

FTS generates a wide range of HC products (olefins, paraffins, oxygenated compounds) and much heat. The product distribution is a function of temperature, feed  $H_2:CO$  ratio, pressure, catalyst type and composition. Two processing options are considered for conversion of clean syngas into HCs. As depicted in the figure above, a low temperature process operates at 200-240°C with either a Fe or Co catalyst and tends to show selectivity for waxes. These in turn can be upgraded to clean diesel fuel containing no sulfur and low aromatics. A high temperature process is also available, operating at 300-350°C with Fe catalyst, this approach yields olefins, which can be upgraded to gasoline.

Catalysts are usually quite active and are subject to contamination and loss of performance. Loss of activity can stem from loss of metals active sites by oxidation, sintering, loss of surface area due to carbon deposit and chemical poisoning. The various processes available differ mostly in the design of the reactor. These designs include the multi-tube fixed bed reactor, the circulating fluid bed, the fixed fluid bed and the slurry (3 phases) reactors. These designs and much of the process development focus on heat removal and temperature control.

R&D efforts, publications, patents and business activities dealing with FTS are numerous and the level of interest is still high. Documents (5, 6 and 7) from the reference section attest to some of the activity over the past few years and the seemingly high level of action in 2005. Indeed many projects are in the advanced planning stages or under construction. Large and small companies are involved in the technologies including FMC, Rentech, Marathon, BP, Shell, Eastman to name a few. A variety of countries are also getting involved in or considering large scale production such as China, India, Iran, Columbia, Philippines, and some activity is stirring up in the US.

FTS reactions are the  $nH_2 + mCO$  reactions allowed, under specific process conditions, to initiate chain growth. The synthesis is kinetically controlled and intrinsic kinetics is stepwise chain growth. By the nature of this mechanism, the selectivity for HCs can be predicted as a simple statistical distribution. One such model, known as the Anderson-Shulz-Flory (ASF) distribution, describes the weight fraction distribution of product chain lengths versus the probability of chain growth number. Irrespective of operating conditions, [3.3(16)] FT reactions always produce a range of olefins, paraffins, and oxygenated compounds. Process and catalyst optimization are based on desired products/selectivities.

The technology was developed in Germany prior to WWII and later improved in South Africa in the 50s. The processes are well-known and proven practical at large scale. Smaller scale operations are less common and may be practical and economical for simple clean feedstock and highly selective production.

Catalysts are usually Group VIII transition metals, known for hydrogenation of CO. In order of activity,  $Ru > Fe > Ni > Co$  and affect selectivity:

- Ni: good for  $CH_4$  production, high activity, low selectivity
- Ru: good at producing higher MW compounds at low temperatures, high activity, high selectivity, \$\$\$\$\$
- Fe: will make oxygenated compounds, high activity, broad selectivity, hi pressure, WGS activity, easy C deposit, \$
- Co: no oxygenated compounds, high activity, low pressure, no WGS, \$\$

Catalyst properties that are the subject of most R&D efforts are lifetime, activity, and selectivity. Catalyst development is ongoing.

Reactors are designed for removal of large amounts of heat critical to the control of temperature, which in turn has effect on C deposit, deactivation of catalysts and increases the production of undesired  $CH_4$ . The most popular designs commercially tested include the multi-tube fixed bed, the circulating fluid bed, the fixed fluid bed and the fixed slurry bed reactors. Of all of these approaches, the least expensive is the slurry bed design that also offers practical advantages in mass transfer, size, T control, catalyst loading, attrition rates and conversion.



Catalyst degradation is due to loss of active sites to oxidation, sintering, C deposit, and chemical poisons. C deposits are unavoidable and affect Fe more than Co catalyst. Theoretically, C contamination is reversible but may not be practical. Process optimization will reduce the rate of coking. Sulfur is the principal chemical poison and affects Co more than Fe. Halides and nitrogen compounds are also of concern and must be controlled. Although stringent purity requirements are imposed on FT feed gases, commercial processes are available to clean the syngas and meet the specs.

FT diesel fuels have no sulfur, high cetane number and low aromatics and compare very well with conventional fuels in matters of emissions. Indeed FT diesel emits less HCs, CO, NOx, and particulate matter. No real advantage has been reported in terms of energy consumption and green house gas emissions for production (natural gas or coal feedstock). This later statement does not apply for biomass feedstock where a net advantage would be observed. Here again the majority (>50%) of capital costs for FT production comes from syngas generation (from natural gas). Higher fractions will result for solid fuels (coal, biomass).

FTS maybe suitable for the Maine project once process and economics have been evaluated more closely for the specific characteristics of syngas from forest biomass conversion. Rentech Inc. suggested that a low temperature process using a slurry reactor with Co catalyst may be practical and economical for the type of syngas we would produce. The product selectivity would be focused on high molecular weight waxes for later upgrading to diesel fuels. Rentech expressed some interest in participating in the development and planning of such a project.

Additional documentation is presented and briefly reviewed in Appendix 2. These documents obtained from the Rentech Inc. web site describe the company's involvement in FTL and more recently in CTL.

Rentech Inc. is a small, entrepreneurial company established to develop practical renewable technologies. It started out focusing on renewable energy technology using biomass to produce diesel fuel at a time when biomass was too expensive and petroleum was still inexpensive. It has since demonstrated the operation of the world's largest FT slurry-bed reactors in 1992-93, in Pueblo, CO. It is now poised for moving ahead with 6 US based CTL project opportunities and keeps involved in several projects abroad. The proposed technologies will produce diesel fuel and naphtha from coal and will improve efficiencies with cogeneration of electricity [3.3.5(4)].

### ***FTL Recap***

#### ***Facts***

- Existing plants in South Africa, Malaysia, New Zealand
- Coal is the most common feedstock

- Some plants switching to natural gas
- Many companies considering FTL for stranded natural gas
- Complexity and economics suggest a minimum plant size

#### *Advantages*

- Yields petroleum products consistent with today's fuel supply
- Successful operation of slurry phase reactor
- No sulfur and low aromatic products
- Reduced tailpipe emissions from FTL diesel

#### *Disadvantages*

- Low yields
- Poor selectivity, broad range of products
- Economics dictate use of all product streams = complexity
- May only be economical in areas where petroleum is not prevalent

#### *Catalysts & Poisons*

- Fe and Co more conventional, Ru is novel
- 300-350°C; 200-250°C depending on catalyst
- 10-40 bars; 7-12 bars
- H<sub>2</sub> : CO ≈ 2:1
- 50-90% conversion
- α-olefins, gasoline with Fe catalyst
- waxes, diesel with Co catalyst
- < 40% selectivity
- S, halides and nitrogen compounds are poisons in trace quantities (ppb)

#### *2.2.6 Methanol Catalytic Synthesis*

Variations on the basic FTS are numerous. With the appropriate choice of catalyst and operating conditions, some more selective or specific reaction systems can be exploited to favor the formation of alcohols and oxygenated compounds. Some of these are important raw chemicals and can be considered as fuels or fuel additives. A few potential products for the Maine project will be reviewed below.

The majority of MeOH is synthesized from syngas produced by MSR. The process is high temperature and high pressure, catalytic, exothermic and equilibrium limited. Conversion efficiency is > 99%. Removing large amounts of heat is the current challenge. Numerous methanol converter designs have been commercialized and the process is well understood and of commercial importance.

High temperature (T) and pressure (P) synthesis catalysts are based on ZnO/Cr<sub>2</sub>O<sub>3</sub>. Low temperature and pressure catalysts are based on Cu/ZnO/Al<sub>2</sub>O<sub>3</sub>. The high T & P process has been phased out in favor of the more efficient low T & P process.

Cu is highly sensitive to sulfur poisoning and concentrations should be below 0.1 ppm. Temperature excursions are to be avoided and can rapidly deactivate Cu by sintering. Finally, Cu is extremely sensitive to Cl that must be kept  $\leq 1$  ppb.

MeOH is a commodity chemical that can be used as a fuel or blended with other petroleum products. As a chemical intermediate, MeOH is used in the manufacture of formaldehyde, DME, MTBE, acetic acid, olefins, and a variety of other compounds.

MeOH is a by-product of FTS when an alkali metal promoted catalyst is used. Syngas is transformed into MeOH and water principally but side reactions also produce some EtOH, HAs, ketones and ethers. Distillation separates volatiles, water and HAs. Unconverted syngas is recycled.

Heat removal and temperature control are key to performance. Elevated T increases activity but also allows for more competition from side reactions and shortens catalyst service life. The other challenge to process optimization is overcoming the thermodynamic constraints. The maximum per-pass conversion is limited to  $\approx 25\%$ . Higher efficiencies are possible at lower T where equilibrium is towards product but catalyst activity usually decreases with T. Removing MeOH as it is formed is another strategy to overcome thermodynamic limitations.

Commercial reactors or MeOH converters are of the fixed catalyst bed type with variations on bed arrangements and means of heat removal. Isothermal and adiabatic systems are available. Designs that are more recent adapt the FTS slurry reactor to MeOH production. The slurry reactors work well for conversion of syngas with low H<sub>2</sub>:(CO+CO<sub>2</sub>) ratio into MeOH. Such a system is well suited for coal and biomass gasification applications. A few operational systems using solid adsorption or liquid phase absorption to remove MeOH as it is formed are reported.

The chemistry of MeOH synthesis is interesting. Although MeOH is made from mixtures of H<sub>2</sub> and CO, the presence of CO<sub>2</sub> is highly beneficial and accelerates the reaction. The source of C in the MeOH is CO<sub>2</sub>, which also stabilizes the active Cu phase on the catalyst.

MeOH synthesis at high T (350°C), high P (250-350 bar) on ZnO/Cr<sub>2</sub>O<sub>3</sub> catalyst was the method of choice early on and prior to improved gas purification techniques. Activity and selectivity is high and the catalyst resists sulfur poisoning. This approach was abandoned in favor of the more poison sensitive Cu catalyst operated at lower P & T. The more active Cu/ZnO/Al<sub>2</sub>O<sub>3</sub> operates at

lower temperatures (220-275°C) and lower pressures (50-100 bar). All commercial units use this process and production has been optimized to the point of yielding  $\approx 1$ kg MeOH / li catalyst / hr with > 99.5% selectivity.

In MeOH catalyst formulation, metals contamination must be avoided (e.g., Fe and Ni have FT activity). Furthermore, alkali metals must also be avoided because they favor the production of higher alcohols (HAs). Variations in catalyst formulations have improved MeOH activity in systems rich or depleted in CO or CO<sub>2</sub>. The major cause for Cu catalyst deactivation is poisoning and/or sintering. Cu is extremely sensitive to S which needs to be  $\leq 0.1$  ppm. High H<sub>2</sub>O concentrations can also interfere with activity. ZnO in the formulation helps protect Cu from S poisoning as a secondary function. Chlorine is also a severe poison of Cu sites and must be kept  $\leq 1$  ppb. Other contaminants to avoid are Fe and Ni carbonyls, alkali metals, As, and P.

Notice of these potential poisons is important in the case of the Maine project. In commercial MeOH production from natural gas/syngas, poisons for MeOH catalysts are also poisons for the reforming catalyst and thus, thoroughly removed before reforming. For Maine, such provisions for gas clean-up will have to be incorporated in the gasification train design.

The low pressure process is more efficient, offers the lowest capital and operating costs and is the only one practiced commercially. Process suppliers include: ICI, Lurgi, Mitsubishi GCC, Haldor-Topsoe/Nihon Suiso Kogyo and Halliburton. The processes used differ in operating T & P, reactor design and catalyst formulations. The world's largest producers are Methanex and SABIC. The largest plant in the world came on-line in Iran in 2004 [2.2.6(4)]. The Eastman Chemical/Air Products & Chemicals demonstration plant in Tennessee is the only liquid phase MeOH installation in operation.

MeOH has many uses:

- Formaldehyde production is the largest consumer of MeOH ( $\approx 35\%$ ). The process converts MeOH and air over Ag or Fe<sub>2</sub>(MoO<sub>4</sub>)<sub>3</sub> catalyst. Commercial processes are well established. Formaldehyde is used to make resins and demand is driven by the construction industry.
- MTBE is the second largest consumer of MeOH ( $\approx 25\%$ ). Used mostly in gasoline (95%) it is also a dewaxing solvent and is employed in the production of isobutene, isoprene, methacrolein and methacrylic acid. The reaction is between MeOH and isobutene on an acidic catalyst (H-ZSM-5, sulfonic acid ion exchange resin).
- Acetic Acid is the third consumer of MeOH ( $\approx 9\%$ ). AcA in turn is used for vinyl acetate, acetic anhydride and terephthalic acid manufacture. The reaction is between MeOH and CO in a liquid phase homogeneous catalysis system. Catalysts are Co, Rh, or Ni promoted with Iodine.

Other MeOH transformations that have potential for the Maine project involve the production of fuels.

#### MeOH to Gasoline (MTG)

This process developed by Mobil Oil Corp., converts MeOH to hydrocarbons (HC) over zeolite catalysts. Mobil's two-step reaction process: first, crude methanol (17% H<sub>2</sub>O) is partially dehydrated on alumina to yield MeOH, DME and water; second, this effluent is mixed with recycled syngas over ZSM-5 zeolite catalyst to produce HCs and water. Selectivity to HCs is greater than 85%; the remainder is LPG. Mobil designed and operated a fluid bed MTG plant in the early 80s, however no commercial plant was built although the technology is ready for use. [XXX]

#### MeOH to Olefins (MTO)

This process is also from Mobil Oil and is a variation on the MTG process. Olefins are an intermediate product in MTG so catalyst and process conditions modifications can shift the selectivity to 80% C<sub>2</sub>-C<sub>5</sub> olefins. Other variations can favor the production of ethylene and propylene. A variation on MTO is MOGD for gasoline and diesel selectivity. Neither processes are in commercial practice but UOP and HYDRO (Norway) license their own MTO process for the production of ethylene and propylene.

#### Topsoe Integrated Gasoline Synthesis (TIGAS)

Integration of MeOH synthesis and MTG processes into a single loop system to minimize capital and energy costs. This approach is possible by reformulating the catalyst and modifications to the operating conditions. It also requires that a mixture of MeOH and DME be made prior to gasoline synthesis. Demo plant was operated in the mid 80s. The quality of the gasoline product is lower (Octane no.) than for MTG product. [REF]

#### Dimethylether (DME)

DME is of particular interest to this Maine project. Indeed, one focus of the study is the conversion of biomass to a higher energy density liquid product. Potential uses for this product are as a fuel on site or transported to a transformation facility as a raw chemical for distribution as a fuel or further processing. Since DME appears in several of the MEOH synthesis processes and in most of the transformation processes more details are in order.

DME is industrially important as starting material in the production of the methylating agent dimethyl sulfate. It is also used as an aerosol propellant. DME has the potential for use as a cooking fuel or a diesel fuel, a refrigerant or a chemical feedstock. Commercial production of DME is a byproduct of high pressure MeOH production. DME is formed in a two-step process where first, MeOH is synthesized, and then it is dehydrated over an acid catalyst such as  $\gamma$ -alumina at MeOH synthesis conditions. The reaction scheme involves the methanol synthesis from H<sub>2</sub> and CO; the methanol dehydration; and the water

gas shift reaction. One product in each reaction is consumed by another reaction. This synergy results in higher conversion for DME (per-pass: 50%; total: 95%) than for MeOH (per-pass: 14%; total: 77%). The optimum H<sub>2</sub>:CO ratio for DME synthesis is lower than for MeOH. Ideally, it should be around one, which is good news for the Maine project.

Recent developments in catalyst formulation and process design suggest the possibility of direct DME synthesis from syngas in both the gas phase and the liquid phase processes.

The suggested cost of DME production (1999) is \$0.67/gal while MeOH is \$0.35/gal assuming the price of natural gas is \$0.60/MMBTU [XXX]. We can safely assume that these values have since change significantly. In Appendix 4, the authors reviewed and assembled other documentation.

#### M100 and M85

MeOH can be used as a fuel, neat or partially diluted with gasoline. These fuels present a variety of advantages and disadvantages over conventional gasoline. Use of these fuels requires modifications to handling and combustion systems. These modifications have been done successfully but large-scale use has not yet developed; incentives are probably missing. MeOH is also being considered for use in fuel cell applications.

Costs of MeOH vary greatly and are highly dependent on the availability of imports and on the price of natural gas (e.g. \$0.62/gal, Jan.03) [XXX]. Most of the plant capital cost is associated with the reforming and gas conditioning steps for the typical processes. The slurry reactor approach reduces the capital cost and compression costs. A 2000 study, suggests that MeOH from biomass would cost \$0.30 - \$0.55/gal more than that from natural gas [XXX]. Table 16 in Appendix B presents results from several economic studies.

#### **MeOH Recap**

##### *Facts*

- Predominately from syngas made via SMR
- Several automakers have developed prototype direct MeOH fuel cell vehicles
- Commodity chemical
  - Used in half of the worldwide production of acetic acid
  - Formaldehyde production is the largest consumer of MeOH

##### *Advantages*

- Mature technology
- Many uses (formaldehyde, acetic acid, DME, MTBE, MTG, MTO, MOGD)
- Fuel used as M100 and M85
- Possible source of H<sub>2</sub> & MeOH reforming is a practiced technology

### *Disadvantages*

- Have to compete with mega MeOH plants
- Liquid phase MeOH still in development stage
- Poor solubility in gasoline and phase separation problems
- More corrosive than gasoline
- M85 has not developed on a large scale

### *Catalysts & Poisons*

- ZnO/Cr<sub>2</sub>O<sub>3</sub> for 350°C, 250-350 bars
- Cu/ZnO/Al<sub>2</sub>O<sub>3</sub> for 220-275°C, 50-100 bars
- 99% conversion with recycle
- >99% selectivity with recycle
- S, halides, Fe and Ni poisons

### *2.2.7 Mixed Higher Alcohol Catalytic Synthesis*

Mixed higher alcohols (MHAs) are more attractive as gasoline blending stock than MeOH because of the lower vapor pressure, better solubility, better water tolerance and higher heating value. Several processes can be applied to the production of MHAs from CO and H<sub>2</sub> gases. These processes have been known since the early 1900s. Linear alcohols are produced in a stepwise fashion, similar to the FTS process, starting with the synthesis of MeOH followed by successive homologation. The mechanism is complex with numerous reactions and pathways.

Just as for other syngas conversions, an important aspect of the process is the removal of large amounts of heat to control temperature, maximize yields and minimize catalyst deactivation. Reactors are similar to MeOH and FT systems and most effective catalysts are modified MeOH and FT synthesis catalysts. MHAs are favored at higher temperatures and lower space velocities than for MeOH synthesis, with a desirable H<sub>2</sub>:CO ratio ≈ 1.

Higher alcohol synthesis (HAS) has had limited commercial success due to poor selectivity, low product yield and little interest or demand. Several studies based on the use and price of natural gas as feedstock place the price of MHAs around \$0.50/gal - \$1.20/gal.

Several processes can be used but variations of FT and MeOH synthesis are better known and practiced. Single pass yield of HAS is around 10% with MeOH the most abundant product. Branched HAs are typically formed from modified MeOH and FT synthesis catalysts. Straight chain alcohols with ASF distribution are formed with alkalinized MoS<sub>2</sub> catalyst.

MeOH formation is favored at low temperature and high pressure. At high pressure, HAS increases as temperature increases. HAS catalysts all contain an

alkali metal. Major catalysts fall into 4 groups: modified high pressure MeOH catalysts; modified low pressure MeOH catalysts; modified FT catalyts. and alkali doped sulfides (e.g. MoS<sub>2</sub>). The major hurdle to HAS commercial success is the need for catalysts with increased productivity and selectivity to higher alcohols. Sulfide based catalysts are less active than the oxides but more tolerant of sulfur in the syngas. Novel Rh catalysts are being developed for EtOH selectivity but it is thought that the high cost and limited availability of the metal will hinder commercialization of this catalytic syngas-to-EtOH process.

Much detail is given on the various catalyst formulations and their applications as well as process parameters of importance [3.3(16)]. Much research into HAS was carried out by major companies but no commercial plants in operation today. The principal participants were Snamprogetti / Enichem / Haldor-Topsoe, DOW, Lurgi and IFP.

A novel process, Ecalene, at bench scale shows much promise for the selective production of EtOH at comparable temperatures and lower pressures than the more conventional processes.

### ***MHA Recap***

#### *Facts*

- Alcohol fuels developed by many
- Some tested in Europe

#### *Advantages*

- More attractive blending stock than MeOH
- Lower H<sub>2</sub>:CO ratio required

#### *Disadvantages*

- No stand alone commercial plants
- Low yields
- Poor selectivity
- Currently little activity or interest in mixed alcohol synthesis

#### *Catalysts & Poisons*

- Modified MeOH catalysts: alkali/ZnO/Cr<sub>2</sub>O<sub>3</sub> and alkali/Cu/ZnO/Al<sub>2</sub>O<sub>3</sub>
- Modified FT catalysts: alkali/CuO/CoO
- Alkali/MoS<sub>2</sub>
- Same poisons as for unmodified materials (S, halides, Fe, Ni)
- Cu based catalyst: S, COS, halides, unsaturates, Fe, Ni, NH<sub>3</sub>, HCN
- Sulfide catalysts less sensitive to S



### 2.2.8 Ethanol from Syngas Bioconversion

Ethanol is the only renewable liquid fuel made in commercial quantities. Direct fermentation of carbohydrates or hydration of ethylene is the only two commercial processes practiced. Fermentation accounts for 95% of the global capacity. A catalytic route can be designed from variations in the MHA process discussed above. Modified operating conditions and specific catalyst formulations can yield better selectivity towards EtOH. Small-scale demonstrations are reported using precious metal catalysts [xxx].

The use of microorganisms to convert synthesis gas to ethanol has been demonstrated by Gaddy (Bioengineering Resources Inc.) over the last 10 years at the laboratory scale and pilot plant level. This technology has the potential to be appropriate at a variety of scales and the ethanol is the most clearly defined product option with unlimited markets and important financial incentives. In addition, the current production of ethanol from cornstarch is a vulnerable technology with marginal economics and energy efficiencies. An advantage of this route of particular interest to the Maine project is the ability to process nearly any biomass resource. This is in contrast to corn-based ethanol that only uses grain starches or the biomass fermentation approach (NREL) which can handle only part of the biomass economically. Projected yields for such a biomass syngas-to-EtOH facility are 70-150 gal EtOH/ton dry biomass. The economics are favorable (2003) for an EtOH sales price of \$1.00-\$1.50/gal [REF].

Syngas conversion to EtOH occurs with bacteria specifically designed and grown for the task. The fermentation broth is quite dilute ( $\approx 0.2 - 2\%$  EtOH) and alcohol can be recovered by distillation and adsorption. One advantage of this fermentation route is that all parts of the biomass contribute to the yield of EtOH. Furthermore, it is likely, although not yet confirmed, that the process will be less sensitive to possible contaminants in the syngas.

Along with the production of EtOH from CO and  $H_2/CO_2$  present in the gas, acetic acid can and is formed. The ratio of ethanol to acetate is dependent on the strain of bacteria used and the fermentation conditions. The organisms are inhibited by low pH and acetate ion concentration. When acetic acid is formed, the pH drops and the acetate ion concentration rises. In response, the bacteria switch to EtOH production to alleviate further inhibition.

The fermentor is a three phase sparged reactor with all of the inherent issues and limitations with mass transfer and conversion, volumetric productivity and dilute product streams. The bacteria is considered the third phase in this description and is suspended rather than immobilized. Multi-stage design with bacteria separation and recirculation can improve performance and efficiencies to some extent. Development of more efficient bacteria should also contribute to process improvements, although the system will remain bulky and capricious.

Several individuals and/or organizations are involved in the R&D of this new technology. Supplementary documents have been reviewed and assembled in Appendix 5. Most of the processes developed to date for direct fermentation of biomass-produced syngas are similar in layout, function and operation. The main differences are in the type, properties and characteristics of the bacteria strain developed and used for the task. The conversion of syngas to ethanol as a co-product to other products could be the most important alignment of Maine-available feedstocks, conversion technology, and products for near term deployment.

### ***EtOH Recap***

#### ***Facts***

- Currently produced primarily via direct fermentation of carbohydrates

#### ***Advantages***

- Is currently a fuel additive
- Currently has a tax credit
- Compared to direct fermentation, able to process nearly any biomass resource

#### ***Disadvantages***

- No commercial plants for catalytic or direct fermentation routes for syngas-to-EtOH
- Many universities have worked on syngas fermentor designs but present status of work for most is unknown
- Pilot plant scale operations still in early stages
- No full scale plant operations and economics data

#### ***Catalysts & Poisons***

- Modified FT and MeOH catalysts
- Novel precious metal (Rh)
- Same poisons as for unmodified material
- Small variety of bacteria strains, more or less specific to EtOH selectivity
- No data for poison effects on direct fermentation operations

### ***2.2.9 Combustion***

The integration of biomass gasification with combined cycle power generation (IBGCC) has the promise of high efficiency conversion (40%). This technological route has been demonstrated for coal on a commercial scale and for biomass on a pilot scale. Currently, Maine has 250 MWe of bio-power produced via combustion-steam turbine systems which operate at an efficiency level of 20%. Doubling the output from these systems is a good idea when green electricity and carbon credits for avoided fossil fuel use can be sold as co-products [REFS].

In virtually all conversion options, the use of gasification for the conversion of residues to heat and power could be a keystone in the process with excess power sold on the grid.

### *2.2.10 Case Descriptions*

The catalytic conversion of syngas to chemical products is almost unlimited in theory but only three products need to be seriously considered:

- Ethanol, via mixed higher alcohol synthesis and separation
- Dimethylether (DME) via methanol synthesis
- Hydrocarbons, via Fischer Tropsch synthesis.

If bio-oils are not the desired products of the biomass thermochemical transformation, the first stage pyrolysis can be followed by gasification. This scheme does not necessarily occur in two separate and distinct unit operations. By approaching this process as two steps, pyrolyser and gasifier, we can envision the possibility of a slip-stream of bio-oils from the pyrolyser section if need be and economically appropriate. This introduces a much higher level of complexity to the process along with higher costs but provides more flexibility of production.

These ideas and concepts are depicted in the two diagrams: G1a and G1b - G2. Here, the layout is similar to the two earlier ones but the thermochemical reactor shows both pyrolyser and gasifier functions. As depicted, recirculation is also suggested here and should be considered with the same cost/benefit concerns as mentioned earlier. The effluent stream G/S separation step should be less complicated than for the bio-oil production case but are still not easy (less concern with condensables but higher temperatures).

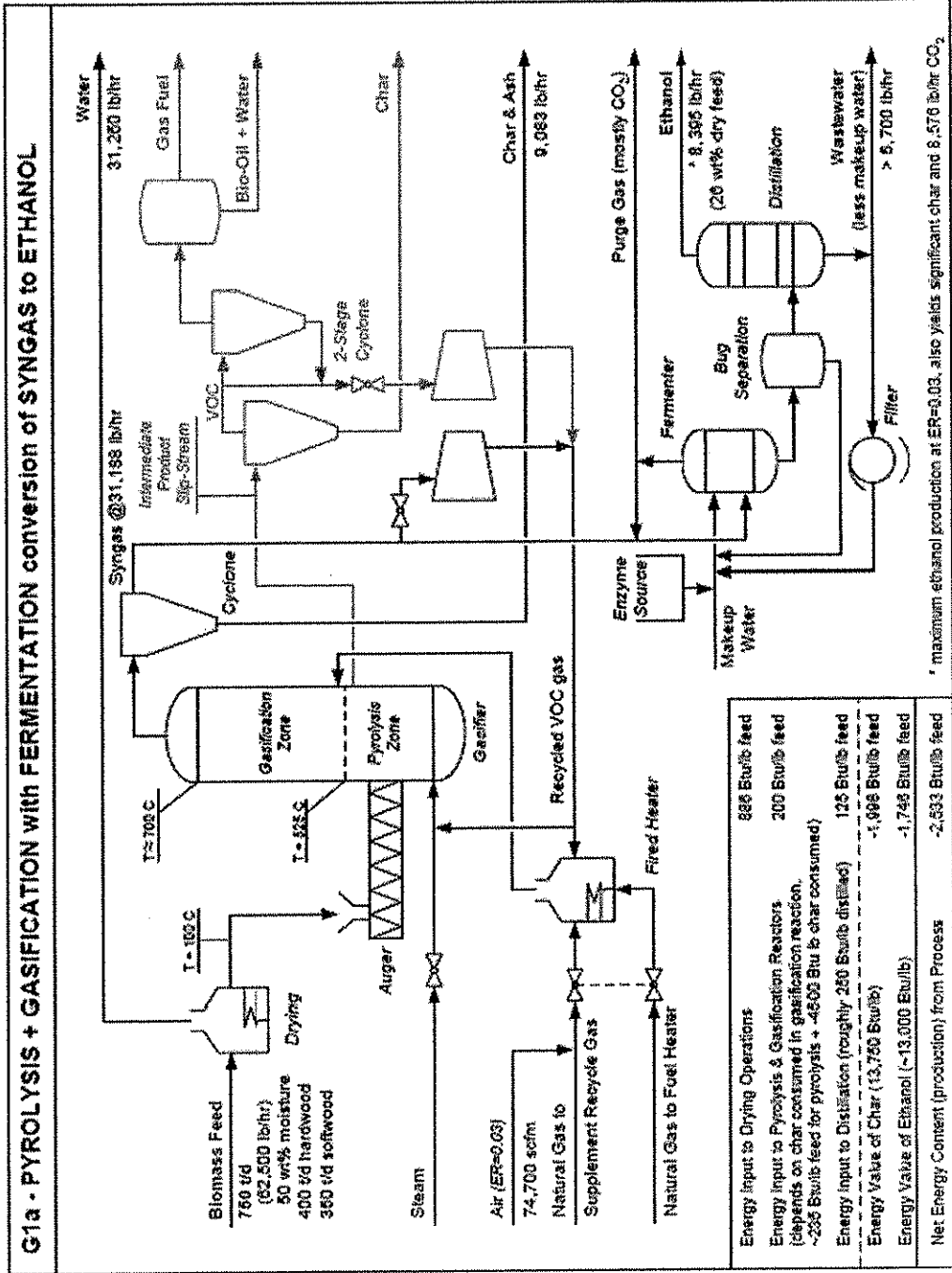
The high operating temperatures reached in the gasification step will result in a gas product stream with an appreciable amount of char and ash solids. The gas is syngas and is composed of hydrogen, carbon oxides, water,  $N_2$ /  $NO_x$  (from air), some hydrocarbons and some small amounts of volatile inorganic "contaminants". The composition and proportions depend greatly on the nature of the biomass and other feed components (air,  $O_2$ , recycle, etc.) and on the operating conditions. Of particular interest, are the content and ratio of hydrogen and carbon monoxide,  $H_2/CO$ , in the syngas, which is critical to further processing. A broad variety of intermediate and/or final products can be contemplated from further syngas transformation.

The gasification flow sheets shown in **Figures 2.10** and **2.11** suggest a few of these product options. For example, the production of alcohols such as MeOH, EtOH or a mixture of alcohols from  $C_1$  to  $C_8$  maybe of interest as a source of fuel

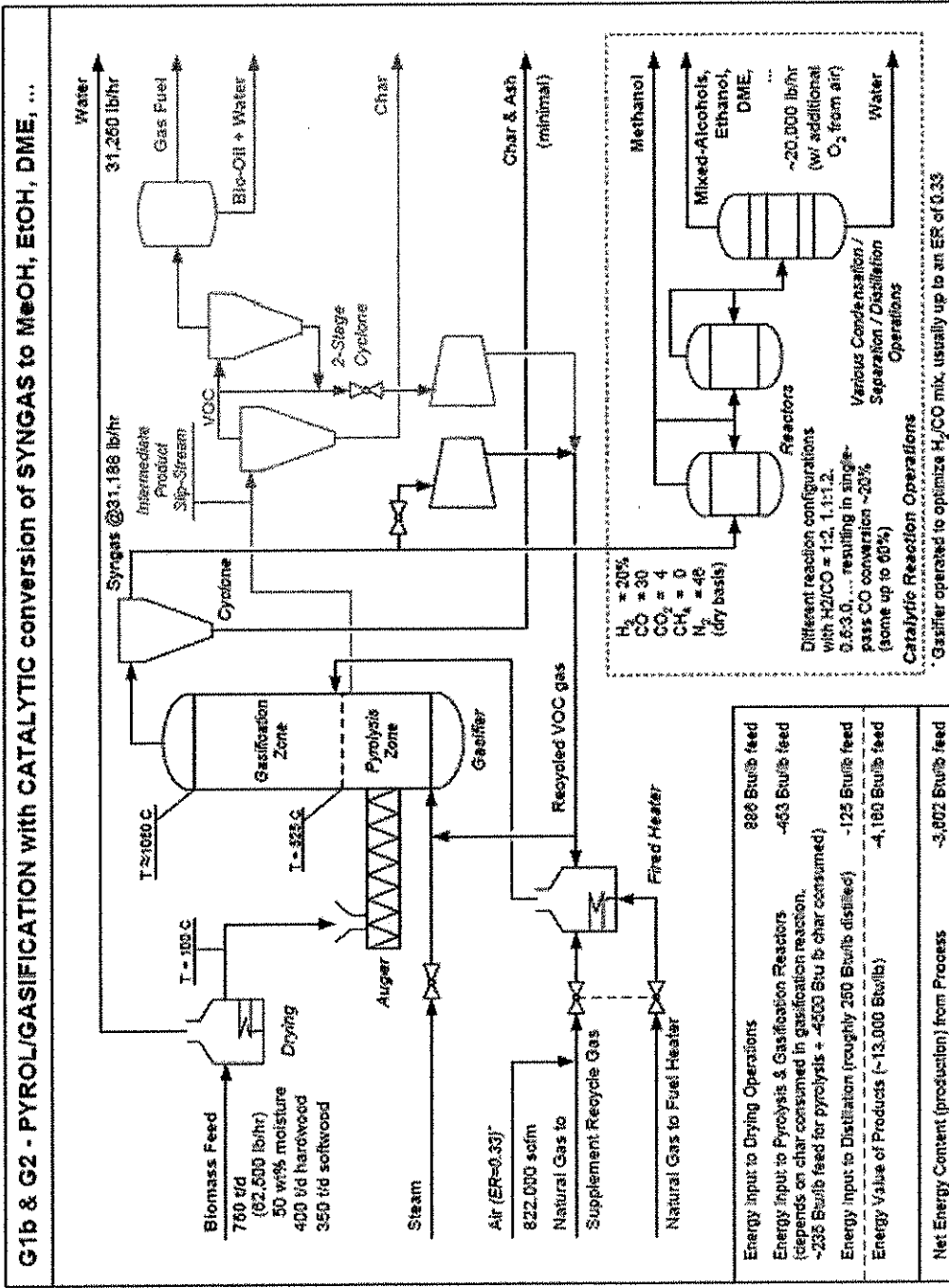
or fuel additives or as an intermediate to the synthesis of other compounds such as DME, acetic acid, formaldehyde and H<sub>2</sub> to name a few.

If the production of a liquid with higher energy density is the target of the syngas transformation, this liquid can then be used as such locally (probably as a fuel) or transported to a larger centralized plant for further processing, transformation and distribution. At this time the suggested syngas transformations are all possible. The production of MeOH is a well-established commercial process although the conventional feedstock is natural gas. The route to other alcohols such as EtOH from a mixture of higher alcohols is also well known but still suffers from low conversions, yields, and selectivity. The production of DME has traditionally been based on catalytic conversion of MeOH but new direct routes from syngas are being developed. The same can be said for EtOH production, which has historically been based on the fermentation of "sugars" derived from a variety of biomass sources (e.g. corn) by a variety of "extraction" processes. Indeed, new and more direct routes from syngas to alcohol products are being developed via catalytic reaction or even direct fermentation of the gas with novel catalysts or specific enzymes. Mixed alcohol production necessitates optimization of feed compositions, catalysts and operating conditions to shift the yields and selectivity towards the desired alcohol. Various R&D groups have proposed direct fermentation routes that appear promising [REF]. Processes are quite similar and differ mostly in the nature of the "active" fermentation ingredients. For the production of EtOH specifically, effluent concentration is very low ( $\approx 2\%w$ ) and fermentation processes have drawbacks (operating conditions, pH, enzyme viability ranges, vessel size, rates, sterile requirements, sensitivity to poisons).

All of these proposed processes are at some stage of R&D or in pilot scale demonstration. Several countries are showing interest in the conversion of biomass to fuels or chemical products by sponsoring or investing significantly in joint ventures to install these demonstration plants. In the past few years, numerous articles have been published describing the involvement of several European countries, Scandinavia, India, China, South America, Canada, Iran, Japan, and Korea [REF].



**Figure 2.10: Mass and Energy Balances for Case G1a – Microbial fermentation of Syngas**



© 2005 Horizon Technologies

**Figure 2.11: Mass and Energy Balances for Case G1b and G2- Catalytic Conversion of Syngas**

## 2.3 Fractionation

Fractionation needs to be considered from three perspectives:

- **Conventional chemical pulping** as practiced in the modern pulp and paper industry as well as and the historical approaches to the separation of fiber from the cell wall matrix as well as delignification.
- Processes that physically and chemically convert wood to cleanly **separated fractions of**
  - Hemicellulose-derived soluble carbohydrates
  - Lignin fraction
  - Cellulose fiber or partially depolymerized glucans that is amenable to chemical processing with minimum degradation products.
- **Integrated fractionation and bioprocessing** where fractionation tools are used as an integrated pretreatment step and result in the target final product such as ethanol and residues.

The major current focus in the world is the integrated fractionation and bioprocessing approach often described as the sugar platform where the lignocellulosic complex is treated to release the approximately 75% of the mass in simple sugars to be then used as feedstock for bioprocesses. Processes that specifically target the qualitatively different structure and chemistry of lignin can then utilize the isolated lignin [REF].

The DOE biomass program begins with mechanical processing followed by dilute acid thermal pretreatment that hydrolyzes the hemicellulose fraction and thereby cleaving the carbohydrate bonds to lignin. This treatment improves both physical and chemical accessibility for enzymes, which then uses the enzymes to convert the cellulose to glucose [REF].

Wooley et al [2.3(53)] use co-current dilute acid pretreatment with the washed solids being subjected to simultaneous saccharification and co-fermentation (SSCF) using cellulose enzyme. The liquor is detoxified by ion exchange and adding lime and then returned to the SSCF fermentor. The authors estimate a cost from \$1.16 to \$1.44 per gallon depending on technical performance and feedstock costs.

The fractionation conversion scheme addressed in this market study is shown in **Figure 2.12**.





solubilization of some phenolics and the decrease in molecular weight are significant potential issues that can affect downstream processing.

In addition there is the cost and process complexity of the explosion process and the amount of water needed for extraction. Avellar and Glasser [2.3 (55)] conclude that production costs of \$0.12/kg of raw material processed and scale has the greatest effect. Capital costs of the steam explosion unit are the greatest contribution to cost. Recovery of the water-soluble solids adds \$0.03/kg.

The lowest total process cost for cellulose fiber, pentosans and alkaline lignin is \$0.22/kg raw material process. Highly specialized markets will be needed to override the value of cellulose fiber, which is in itself a marginal economic activity. Glasser and coworkers found that only two fractions were reliably recovered; an 85-90% cellulose fraction and a 90-95% alkali soluble acid insoluble lignin fraction. The hemicellulose fraction was severely degraded when it is divided between water soluble and an alkali soluble fraction at high severity,.

Bozell (NREL) [2.3(57)] proposed the following criteria for evaluating fractionation options:

- Selectivity
- Accessibility
- Recoverability
- Utility
- Economics

The NREL Clean Fractionation process is based on a ternary solvent system using methylisobutyl ketone (MIBK), ethanol, and water in the presence of acid at temperature and pressure. The results from this work have not been published in detail. Other solvent pulping, such as the organosolv process [REF?] and the ALCELL process, uses ethanol alone. The Natural Pulping process uses formic acid. The biggest concern for all organosolv processes is the cost of handling organic solvents as well as environmental and safety issues. Nevertheless, the solvent approach does offer an alternative that might minimize the degradation issue.

All fractionation approaches face the same challenge of overcoming the inherent stability of the cell wall system. To relate fractionation efficiency and material degradation from different approaches, Overend and Chornet [2.3 (59)] proposed the severity factor  $R_0$ , where

$$R_0 = \int \exp[(T_r - T_b)/14.75] dt$$

$T_r$  is the reaction temperature  $T_b$  is the base temperature of 100 °C and  $t$  is the reaction time. The parameter  $R_0$ , (typically 5000-35,000) or  $\text{Log } R_0$  (3.7 – 4.5), is used to track the tradeoff between time and temperature.

A third factor in the comparison is the presence of catalysts. As mentioned above, acid hydrolysis has been applied for years with dilute acid pretreatments being the basis of the sugar platform. The direct separation of hemicellulose from aspen was performed by Gabriellii et al [2.3 (61)] using alkali extraction combined with ultrafiltration. Polymeric xylan was recovered with 6% lignin. However, the authors state that the process must be adjusted for each feedstock. Some processes claim to use only water as an additive relying on elevated temperatures and pressure for dissolution of labile acid groups and phenolic constituents that can catalyze and facilitate the depolymerization of hemicellulose and lignin. One of the major problems with this approach is the variation that will inevitably occur when different feedstocks are used with different amounts of ash and acetyl groups.

A group of research organizations has formed the Consortium for Applied Fundamentals and Innovation (CAFI). The concentrated acid approach is based on concentrated sulfuric acid to disrupt the hydrogen bonding and make the cellulose accessible to hydrolysis under dilute acid conditions at elevated temperature. The dilute acid pretreatment can be combined with concentrated acid hydrolysis to remove the C5 sugars followed by dilution with water. Arkenol and Masada currently practice the concentrated acid approach [2.3(25); 2.3(63)].

Dilute acid hydrolysis is also practiced as a two stage process with control of temperature and acid concentration at each stage, and typically at short reaction time. BC International attempted to build a plant to run on bagasse. Iogen and Petro-Canada collaborated on a project using Iogen's cellulose enzyme after dilute acid pretreatment and is producing cellulose-derived ethanol commercially [Ref]. Also practiced is alkali pulping in the first or second stage. The NACO [2.3 (65)] process uses a sodium carbonate catalyst. The Universal Pulping [2.3 (65)] process is a two stage acid/alkaline pulping process to separate biomass in three fractions using nitric acid at 80-100 °C in the first stage. There are no commercial operations at this time.

The concept of reaction severity developed by Chornet and Overend [2.3 (59)] shows the tradeoff between temperature, time and catalyst concentration. Another variable is mechanical action such as in steam explosion and mechanical agitation. Extrusion pulpers can enhance reactivity through physical action and mass transfer as well as compression and decompression. These units are best suited to mini-mills of less than 100 tpd.

Some sulfite pulp mills also utilize a dilute acid hydrolysis process to remove some of the hemicellulose from wood prior to pulping. One of the advantages of the chemical pulping systems such as the kraft process, in addition to the catalyzed and facilitated reactions, is the ability to buffer and control the rate of

reaction so that time is predictable with minimum degradation and reversion reactions.

### 3.0. Product Market Status and Trends

The objective of this project is to determine the market potential of specific examples of bioproducts and a strategy to implement this community-driven project. This section on market status and trends will lay out a list of possibilities with the principle definition focusing on the relationship of conversion technology to the feedstocks and the potential markets. Several key aspects of the situation need to be considered:

- *Develop a Vertically Integrated Market Focus*
- *Forge a Regional Strategy*
- *Build on Maine's Petroleum Infrastructure*
- *Enter the Petroleum Value Stream*
- *Focus on the Heating Oil Market as the Cornerstone of the Biorefinery*
- *Evolve into the Market for Green and Natural Products*
- *View Energy Production as a Catalyst for Manufacturing Growth*
- *Understand the Supply and Demand Problems with Electricity*
- *Fill the Natural gas Vacuum*
- *Understand the Western European Chemical Industry*

These possible market initiatives are beyond the scope of this study but are briefly described below.

#### *Develop a Vertically Integrated Market Focus*

Since the focus is on economic development, it makes sense that much more be made in Maine from the basic natural resource that is harvested. The chemical industry has used this approach with crude oil. An example is nylon, which has its largest market in carpeting. The monomers of both nylon 6 and nylon 66 are both high volume and high value. Historically a company like DuPont, the leading manufacturer of nylon 66 extended its control in both directions – back to the refining when they bought Conoco and toward the marketing of carpets. By doing so they had more control over the cost of raw materials and in setting the value of the products. This is a good example since DuPont has dismantled that value chain in recent years including abandoning their world-class fiber manufacturing capability and by selling Conoco. This does not disprove this approach but rather shows how a company like DuPont is continually reinventing itself to take advantage of the changing business landscape [3.1.2.1(60); 3.6.3 (6)].

#### *Forge a Regional Strategy*

Maine and in particular Western Maine is well situated to provide a regional bio-resource for the densely populated Northeast, which includes the six New England States and the three Middle Atlantic States (New York, New Jersey, and

Pennsylvania). This area has a total 2005 estimated population of 54 million with 80% living in urban areas [3.0 (44)].

As discussed in Section 1.0 on feedstocks, the characteristics of the Maine woods must be the foundation of a regional bioenergy strategy. Maine has a diverse forest and approaches for various regions of the country with different forest compositions so approaches defined for the Northwest, Southeast, Appalachian, and Great Lakes states will be different. Maine's approaches to a bioenergy strategy will be defined based on the diversity of its forestland as will the approaches defined by the Northwest, Southeast, Appalachian, and Great Lakes states will reflect the diversity of their respective forests [REF]. This difference is small compared to the Midwestern biomass approach that is evolving out of the growing corn ethanol and soy biodiesel biorefinery. Instead, Maine and the Northeast have the pulp and paper mill as the model for a bioenergy plant including upper and lower limits on size. It was shown in the first section that Pulp and Paper is an imperfect model for forging an integrated long-term strategy because of the lack of vertical integration in the Maine economy. It was also concluded that the first generation biorefinery should be integrated as much as possible with the existing mills and not set up as a competitive market for feedstock.

The Midwest has the strongest developing biorefinery based on the evolution of the corn dry mill. This approach has attracted both government and private investment to catalyze the extension to lignocellulosic biomass [3.0(38)]. Another example of a regional feedstock focus is Louisiana's concentration on sugar cane as a source of chemicals based on sucrose instead of starch [3.0(36)].

The relationship between feedstock and conversion technology is also a cornerstone of the strategy. Herbaceous species in the Midwest is naturally linked to biochemical processing as all the major DOE biorefinery demonstration projects are located in that region [3.0(34)]. These sugar platform biochemical routes are based on the cornstarch to ethanol cornerstone market. The prospects of fractionating forest feedstocks are not good, especially if the feed is residues with a heterogeneous composition. Hence, the syngas platform is the most appropriate as the cornerstone approach.

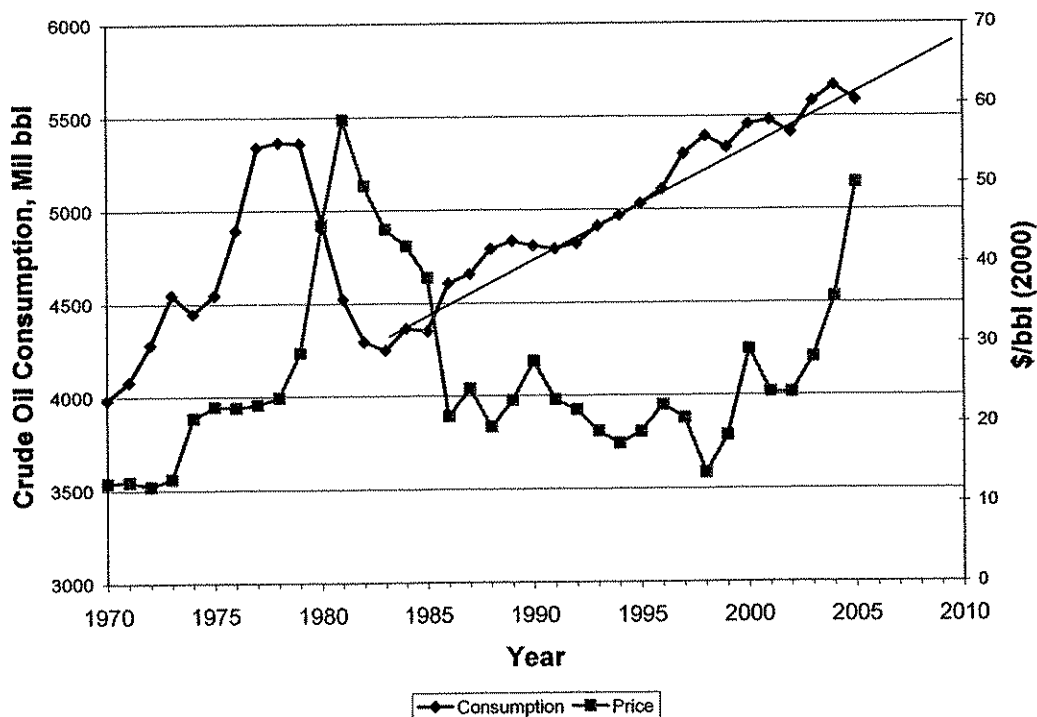
#### *Build on Maine's Petroleum Infrastructure*

Maine has no refineries and only a few pipelines that carry crude oil (Portland) and refined products (Buckeye, Exxon/Mobil) to refineries and bulk terminal plants near Montréal [Ref]. Maine can use conventional gasoline in the winter and lower 7.8 Reid Vapor Pressure (RVP) in the summer [3.0(28)]. Most petroleum products are brought in by ship to one of the several ports along the coast. This modest infrastructure should be studied for ways to bring the

biomass derived-products to the market. The paper industry in Maine has long benefited by proximity to the largest market in the world and that same approach needs to be developed for biofuels. Partnerships with refiners are likely to be difficult because of operating constraints, but secondary relations can be developed with existing companies that provide hydrogen over the fence.

### *Enter the Petroleum Value Stream*

Nothing is more assured than the market demand for liquid fuel replacements. This is now driven by economic, environmental and security reasons, which will not diminish with time. These issues have been the main drivers behind ethanol's impressive market penetration along with agricultural policy. The consumption of crude oil in the U.S. in 2003 was approximately 5.5 billion barrels which was converted to 3 billion barrels of gasoline and 1.4 billion barrels of distillate fuel oils as well as other products [3.0(60)]. The variation of consumption and price (2000 dollars) is shown in **Figure 3.1**.



**Figure 3.1:** Consumption and price of crude oil in the United States. Source: *Petroleum Supply Annual, U.S. Department of Energy, Energy Information Administration (data for 1970-2002)* [3.0(2)]

The fall off in consumption in 1980 may be attributable to the price spike, which may mean that the consumption rate and price is about to repeat this dramatic turn around in the next few years. The impact of economic growth needs to be

considered as well since the change in 1980's was most likely due to economic recession, which does not appear to be likely in the near term.

Biomass-derived feedstocks will enter the refinery in the context of the refinery unit operations. The first operation is distillation. One can envision a crude hydrocarbon mixture from bio-oil hydrogenation or Fischer Tropsch syngas processing entering here. Heavier distillation fractions will undergo hydrotreating and result in intermediate products converted to hydrogen on site as for this process. Alkylation units combine propylene and butene with isobutane to develop a high-octane gasoline-blending component, so that DME could be converted to olefins on site and used in the alkylation unit. All of these paths represent virtually unlimited markets for refinery feedstocks that can stabilize the price of biomass and support large-scale investment in core capabilities. Using the rule of thumb that the value of the product needs to be at least three times the feedstock cost, means that wood at \$60/dry ton or \$0.03/lb can support products at the refinery gate of \$0.10/lb which is equivalent to \$38/barrel assuming the energy density of DME for the derived product. These numbers are competitive by historical standards and are likely to remain so.

This integration with the petroleum value stream will enable two secondary market efforts to develop in Maine:

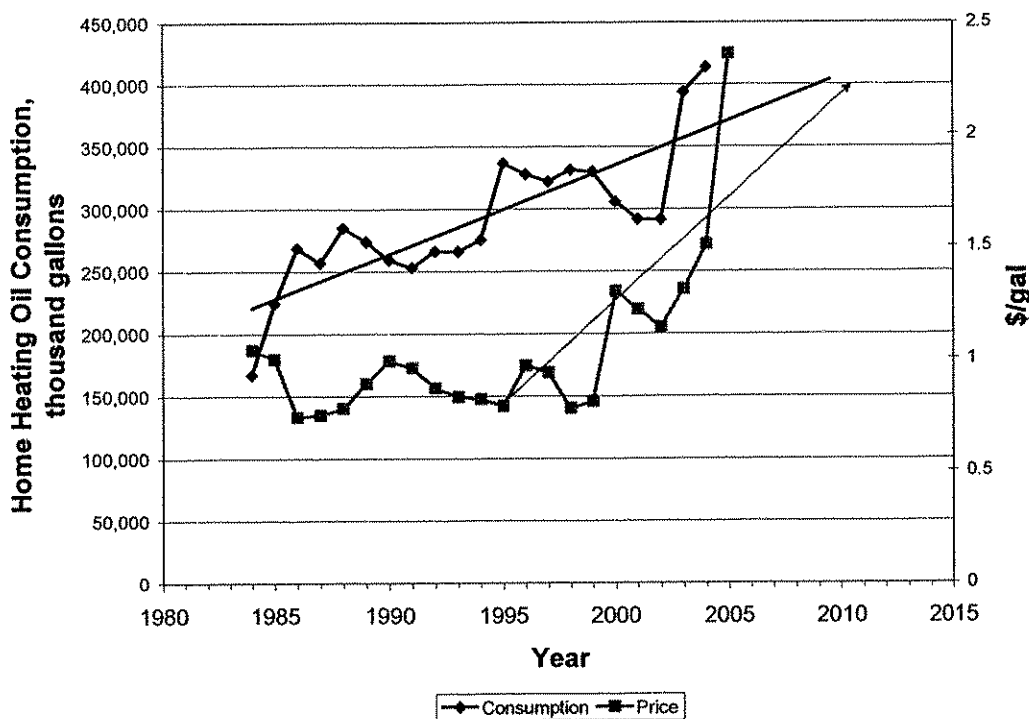
- The evolution of small scale processing and direct marketing of energy products such as home heating oil
- The development of high value product recovery for specialty chemicals.

These paths are not likely to be significant on their own because of technical risk, cost, and market barriers, however, over time the ability to develop feedstock specific coproducts can grow up around this unlimited demand for forest resource.

#### *Focus on the Heating Oil Market as the Cornerstone of the Biorefinery*

The Northeast Region is the area where home heating oil supply and price is of primary interest. Of the 20 million households in the region, 9.2 million use natural gas, 7.1 million use fuel oil and 2.3 million use electricity. Commercial use is 45% natural gas and 34% fuel oil [3.0(16)].

**Figure 3.2** shows the trend over time in consumption and price of home heating oil in Maine [3.1.3(20)]. The trend in price corresponds to the price of crude oil and the increasing cost in recent years could be a spike that will settle down to the historical upward trend. The surprising trend is the steady increase in consumption. Putting these two trends together shows the potential for a billion dollar market in 2015. **Clearly, finding substitution products now that can be blended with heating oil is a priority. Maine need not look any further to find a viable market for the forest resources in the state.**



**Figure 3.2:** Home heating oil consumption and cost in Maine. . Source: Petroleum Supply Annual, U.S. Department of Energy, Energy Information Administration (data for 1980-2004) [3.0 (2)]

*Evolve into the Market for Green and Natural Products*

One area of potential growth is the production of products that are desired by the consumer and can catalyze the growth of new product development companies. The highest values are in food, health and beauty products. The two routes to these types of chemical and biochemical products are through separations and bioconversion. The concept of citing these operations at a bioenergy plant has several advantages such as the ability to skim low quantity materials from a large volume of material, the availability of heat and power, and water treatment systems. An example of this is the steam distillation of extractives from bark prior to pyrolysis.

*View Bioenergy Production as a Catalyst for Manufacturing Growth*

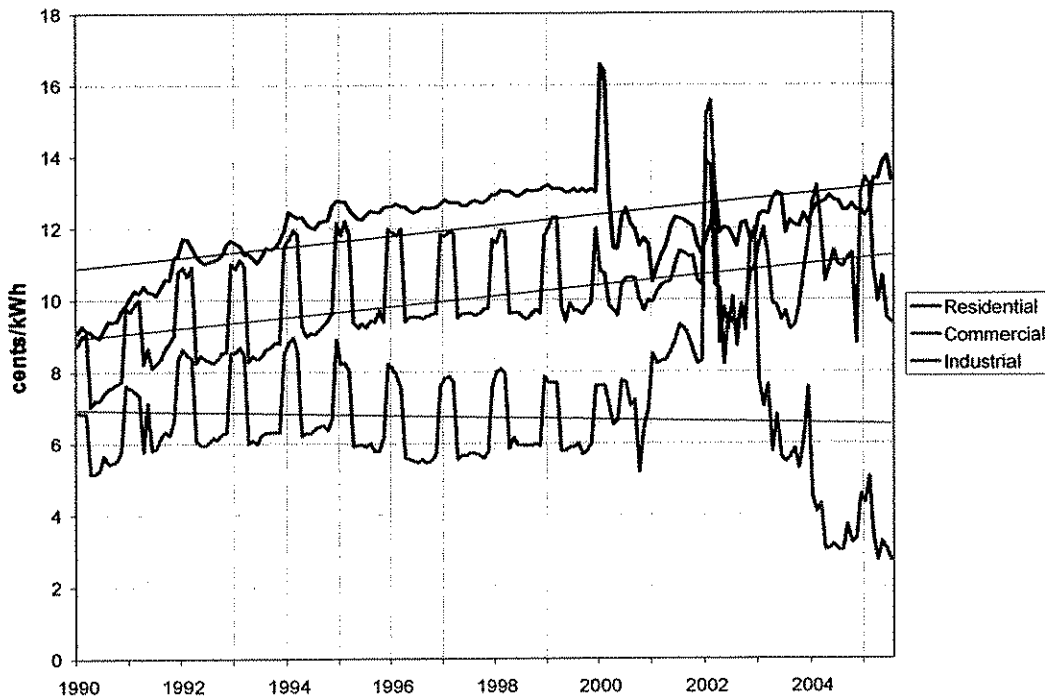
Quality manufacturing job creation is of such importance that a strategy of bioenergy as a catalyst to form new green manufacturing and technical services needs to be addressed in the growth or expansion of time phased development plans. The recommended emphasis on petroleum replacement is only the first step, but one that will facilitate the development of processes and markets for



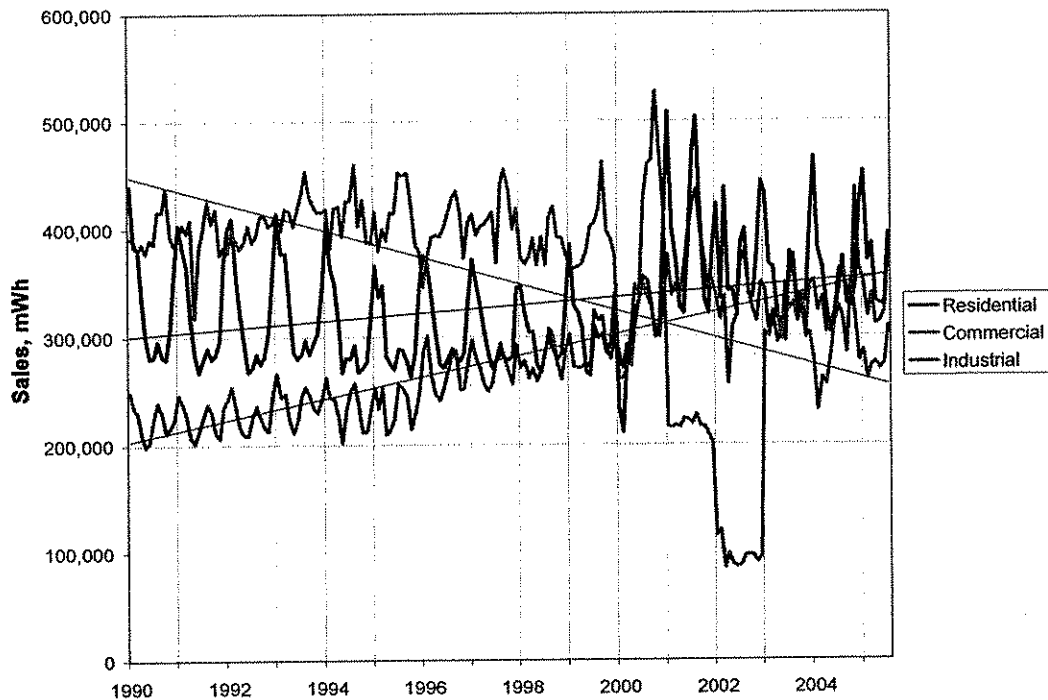
higher value products. Products such as bio-based synthetic polymers based on current monomers such as propylene and as part of the growing search for biobased sources for new starting materials. This approach is not recommended as a first step because of the head start that the corn-based biorefinery now enjoys. However, this is a good example of product development based on the initial development based on corn ethanol followed by the definition of integrated biorefineries where higher value products are made in conjunction with ethanol.

*Understand the Supply and Demand Problems with Electricity*

Maine's electricity market is an enigma and a serious deterrent to industrial growth. Rates are historically among the highest in the U.S. where in 1999 the residential average was 13 cents per kWh compared to a national average of 8.16 cents. In 2000, Maine opened the power industry to competition [3.0(12), 3.0(20)]. In **Figure 3.3**, the monthly average by sector from 1990 to 2005 shows the disruption in all three markets that occurred after deregulation. The total sales are shown in **Figure 3.4**. Despite the fact that all three sectors have the same market share, the costs are significantly higher for residential and commercial customers.



**Figure 3.3:** Monthly cost of electricity in Maine by sector [3.3.1(44)]



**Figure 3.4: Monthly sales of electricity in Maine by sector [3.3.1(44)]**

*Fill the Natural Gas Vacuum*

In 2002, the natural gas market consisted of 17,000 residential customers, 7,400 commercial customers and 66 industrial customers consuming 1, 5, and 4 billion cubic feet respectively [3.0 (2)]. The average prices paid were \$11.78, 9.55 and 8.44 per thousand cubic feet [3.0(14)]. The biggest use however is by the electric power industry using 90 billion cubic feet or 90% of the total in the state [3.0(16)] with an average cost of \$4.09 [3.0(18)].REVISE

*Understand the Western European Chemical Industry*

The current Western European market situation is a good model for the future in North America as it evolves into a high cost producer serving large local markets, which are geared toward higher value products REVISE [REF].

### 3.1 Bio-Oil

There are many potential benefits of biomass-derived liquid fuels and intermediates, not the least of which is the ease of interface with the petroleum industry. Bio-oil is attractive because of the potential to site conversion plants close to the feedstock and operate the plants with operating systems that are more like power plants than chemical operations. In fact, there have been no government or industry initiatives to push this concept through the development and demonstration phases despite the conceptual simplicity of the unit operations. The reactor can run at atmospheric pressure and at relatively low temperatures. The condensed products have low flammability and toxicity. Bio-oil is often criticized as having a low pH and high viscosity when in fact neither are significant problems from an industrial perspective as an intermediate feedstock, but rather when considered as a modern direct fuel. The properties are shown in Table 3.1.

**Table 3.1: Pyrolysis Liquids Properties<sup>1</sup> [3.1.3(10)]**

Property	Pyrolysis liquids from different feedstocks				Mineral oils	
	Birch	Pine	Poplar	Various	POK 15	POR 2000
solids (wt %)	0.06	0.03	0.045	0.01-1		
pH	2.5	2.4	2.8	2.0-3.7		
water (wt %)	18.9	17.0	18.9	15-30	0.025	<7
density (kg/m <sup>3</sup> )	1.25	1.24	1.20	1.1-1.3	0.89	0.9-1.0
viscosity, cSt (50°C)	28	28	13.5	13-80	6	140-380
LHV (MJ/kg)	16.5	17.2	17.4	13-18	40.3	
Ash (wt %)	0.004	0.03	0.01	0.004-0.3	0.01	0.1
CCR (wt%)	20	16		14-23	0.2	
C (wt %)	44.0	45.7	46.5	32-49		
H (wt %)	6.9	7.0	7.2	6.9-8.6		
N (wt %)	<0.1	<0.1	0.15	0-0.2		
S (wt %)	0.00	0.02	0.02	<0.05	0.2	1.0
O (wt %)	49.0	47.0	46.1	44-60	0	
Na + K (ppm)	29	22	6	5-500		
CA (ppm)	50	23	4	4-600		
Mg (ppm)	12	5	3			
Flash point (°C)	62	95	64	50-100	60	>65
Pour point (°C)	-24	-19		-36-9	-15	>15

<sup>1</sup>Birch and pine oils were produced at VTT, Finland. Poplar oil was produced at NREL using hot-vapor filtration. Various includes about 150 oil samples generated by different pyrolysis systems from different feedstocks. POK 15: light-medium fuel oil in Finland, similar to NO. 4 fuel oil. POR 2000: heavy fuel oil in Finland, similar to NO. 6 fuel oil.

The use of bio-oil has the following technical challenges when compared to petroleum liquids:

- Oxygen Content
- Water Content
- Volatility
- Viscosity and Aging
- Corrosiveness
- Combustion Behavior

The use of bio-oil has several potential technical advantages over transported biomass as pellets or wood chips:

- Physical, chemical and biological stability – pellets or chips will be transported and stored in systems where increased moisture could lead to biological activity, which will not happen with bio-oil
- Higher energy volumetric density
- The material can be handled with appropriate industrial systems such as pumps and storage tanks
- Pellet manufacture requires uniform conditions such as moisture content and particle size which will be difficult for heterogeneous feedstock
- The conversion of wood to char and bio-oil leaves most of the heteroatoms in the char and thus bio-oil is a form of refinement over the starting biomass
- In principle, bio-oil as a liquid can be fed into high-pressure secondary conversion systems such as catalytic systems easier than fibrous biomass.

The IEA (International Energy Agency) Bioenergy pyrolysis task proposed specifications to establish commercial standards for bio-oil as shown in **Table 3.2**.

**Table 3.2: IEA proposed pyrolysis oil specifications [3.1(38)]**

Specification	Light Bio-Oil ~#2 ASTM	Light-med. Bio-Oil ~#4 ASTM	Medium Bio- Oil ~PORL 100	Heavy Bio-Oil ~Can. #6
Water, wt %	32	32	32	32
Elemental, wt %				
Sulfur	0.1	0.1	0.2	0.4
Nitrogen	0.2	0.2	0.3	0.4
K+NA, ppm	0.5			
Ash, wt %	0.01	0.01	0.1	0.1
Minimum LHV of wet oil, MJ/L	18	18	18	18
Flash Point °C	52	55	60	60
Viscosity, cST	1.9-4.1@40°C	5.5-24@40°C	17-100@50°C	100-638@50°C
Ethanol insoluble filtered solids, wt %	0.01	CHECK		

Putsche [3.1(38)] has estimated the cost of bio-oil at \$7.62/gigajoule (GJ), lower heating value (LHV) using the following assumptions:

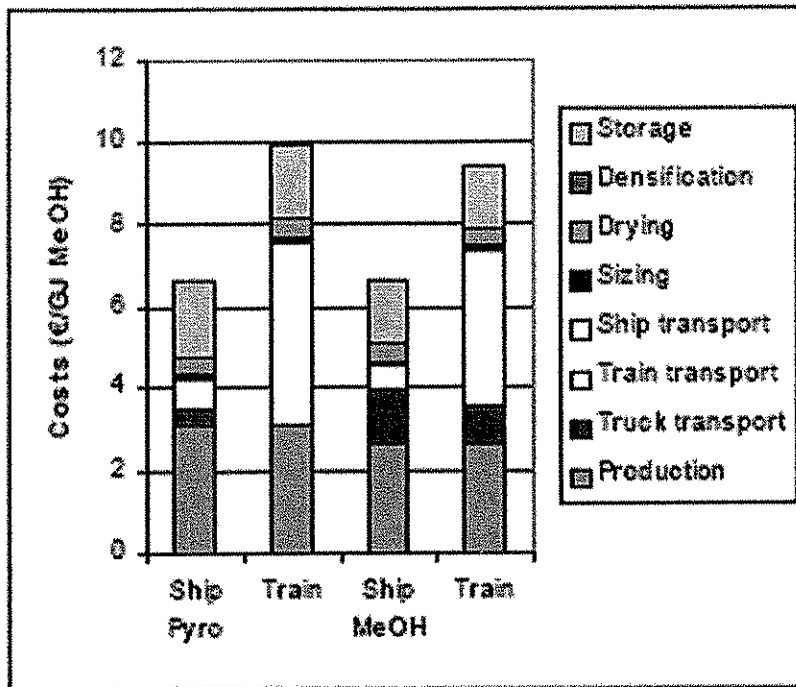
- 550 dry tons/day
- \$30/dry ton feedstock cost, < 3mm particle size, 7% moisture
- Bubbling Fluid bed at 500 °C
- Yields: 60% Oil, 11% water, 16% char, 13% gas
- Capital: installed \$28.4 M, Total \$48.3 M
- Operating costs: \$6.1M/year

Other studies have estimated the cost at \$6.1/GJ at 2000 dry ton/day (Scahill and Amos REF) and \$6.7/GJ by Bridgwater [3.1 (38)]. The Putsche study addresses the potential for cost reduction and identifies scale (increase from 550 to 2000 tons/day), yield from 60 to 70% and the impact of the included contingency factor (reduced from 35 to 10%) in the capital estimate. The latter two of these variables have the potential to reduce the cost to less than \$5.0/GJ, LHV alone. Furthermore, Putsche discussed the upgrading of oil to the level of No. 2 fuel oil by simple methods such as solvent quench and filtration, which would double the value.

Two studies have compared the biomass delivery options. Ringer [3.1(28)] compared the cost of transporting bio-oil versus wood chips and pellets and concluded that bio-oil was significantly more expensive based on the estimate of bio-oil cost performed by Putsche [3.1(30)]: \$10.5/GJ for bio-oil versus \$5.1/GJ for pellets. However, the cost for pelletization used was lower than expected at \$0.4/GJ versus a more conventional rule of thumb of \$1.1/ GJ (\$20/ton). Even raising the cost of delivered pellets to \$6.0/GJ and lowering the cost of oil production to \$9.5/GJ still diminishes the argument for bio-oil as a low cost form of transported bioenergy. It means that the premium paid is in lower cost and more marketable conversion systems.

Ostman et al. [3.1(26)] compared pellets and bio-oil and found that bio-oil may compete for heat production if the byproduct steam is used at the production facility. However, they point out that there are more technical uncertainties with bio-oil than with pellets. They estimate the costs (production, transport 200 km, boiler retrofit) of bio-oil for district heating in a 3MW boiler is \$30.5/MWh (\$8.5/GJ) versus \$33.5MWh (\$9.3/GJ) for pellets.

A thorough analysis of logistics chains for the European case has been performed by Suurs [3.1(32)]. He analyzed the case of transported biomass as logs, chips, pellets, and bio-oil with conversion to methanol considered at different stages in their logistics chain such as close to the feedstock or close to the market.. Suurs analyzed both train and ship transport for the long transport leg.



**Figure 3.5:** Estimates by Roald Suurs of chain costs for a European situation with a coastal central gathering point and an international transport distance of 1500m; conversion costs are excluded [3.1(32)]

The technical challenges are significant, but little effort has been made to address them. Hence, the following conversion options are considered to have high potential for technical and economic breakthroughs and fit the definition of a cornerstone technology.

The status of bio-oil use has been reviewed by Czernik and Bridgwater [3.1(20)]. The biggest level of effort during the 1990's was for use in stationary power generation in burners, turbines, Stirling and Diesel engines. While power applications are not considered a target for this market study, the production of power is a likely byproduct of almost any process. The use of bio-oil for power production is an important first step in oil processing and upgrading since issues of oil properties, injection in high temperature and pressure have been addressed and can serve as a basis for analysis of the market opportunities.

### 3.1.1 Pyrolytic Lignin

The development of conversion systems to remove and convert lignin to products has been a long term goal of wood science and technology. The pyrolysis approach allows fractionation of the lignin from the bio-oil by the simple addition of water. Early work at NREL on solvent fractionation produced a phenolic fraction that was demonstrated as a technical success in wood adhesives. Work

at the University of Waterloo has demonstrated a simpler approach using the separation of a water phase that was labeled pyrolytic lignin [REF]. Ensyn Technologies has developed a lignin fraction from the bio-oil with some post-processing to improve physical properties [2.1(9)].

#### *3.1.1.1 Adhesives*

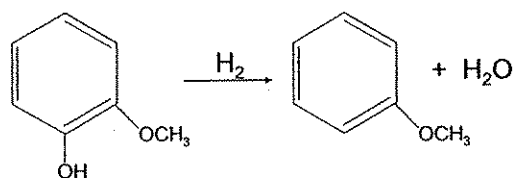
Up to 50% of the phenol in phenol formaldehyde adhesives can be replaced by pyrolytic lignin such as the resoles used in laminated lumber. To date there has not been significant market penetration despite efforts since the late eighties to commercialize this endeavor. There are several reasons for this some of which are common to all new markets for alternative chemicals in established markets and applications. Large manufactures have been hesitant to accept the uncertainty in product durability. The impact of batch variability on manufacturing conditions is another uncertainty especially if it adds to press times and impacts output.

The evolution of the laminated lumber industry with the rise of oriented strand board may present new opportunities for the adhesive replacement concept. An illustration of how this could work in New England is the vertical integration of OSB manufacturing by local sawmills. For example, the Cowsls Sawmill in North Amherst MA [3.1.1.1(48)], is now manufacturing OSB for sale at its retail operation and thereby increasing the profit from small diameter stock that comes off their own woodlots. This integration from woodlot to retail market could be a model for other areas within New England.

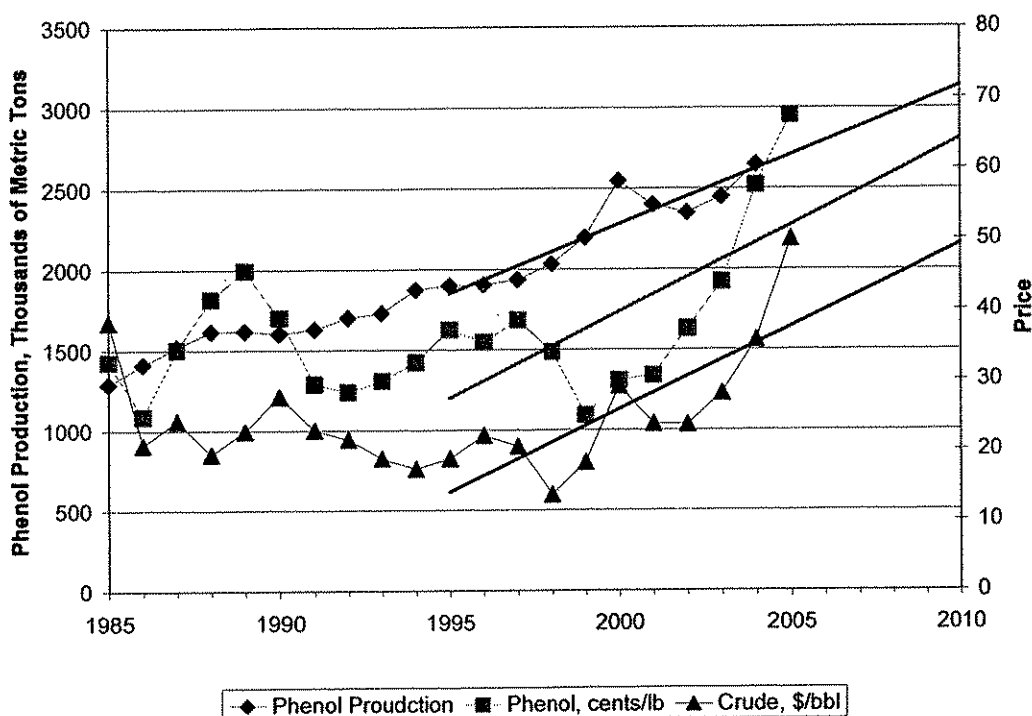
The status of engineered wood products in Maine was reviewed by Kingsley [4.2.1.1(68)]. Maine has three OSB facilities along the eastern Canadian border, and in the southern part of the state; one fiberboard and 1 composite decking. Two of the OSB plants owned by Louisiana Pacific Corp. have been idle at times because of inadequate feedstock supply. These Maine mills are small compared to newer facilities. The Kingsley report demonstrates how growth in the OSB industry is primarily located in the southeastern U.S and Western Canada.

#### *3.1.1.2 Oxy-Aromatics*

The pyrolytic lignin is a candidate for the upgrading strategy developed for lignin from fractionation. This is an important component of case P1 where the bio-oil is fractionated and the lignin fraction is selectively hydrogenated to remove the phenolic OH but leave the aromatic ring and the methoxy group. The prototypical transformation is the conversion of guaiacol to anisole.



A proposed key market indicator of the general class of oxy-aromatics is the market data on phenol shown in **Figure 3.6**. Price is dependent on crude oil and the average of the period 1995 to 2005 shows a positive slope. The U.S. production also shows a significant positive slope with an average growth rate of 3.7%. Wood-derived phenolics are a significant market if production costs can be kept low and product separation processes are developed.



**Figure 3.6:** Phenol market data [3.1.1.1(38)]

### 3.1.2 Hydrogen

The use of bio-oil as a transportable intermediate that can be converted to hydrogen at the point of consumption is a way that renewable hydrogen can be produced in the near term and avoid the transport of hydrogen which adds significantly to the cost of delivery. Mann [3.1.2(14)] has assessed the economic costs of this option and estimates that the hydrogen can be produced for less than \$3.6/kg (gallon of gasoline equivalent). Bio-oil cost is the most sensitive parameter and so a reduction from \$7.60 to \$3.80/GJ for the bio-oil could reduce



the cost to \$3/kg. These production goals in the 2020 time frame are well within the life of bio-oil plants that will be justified by more near term markets that are described in this report. The attractiveness of hydrogen is the range of conversion options that are technically possible. A potentially cheaper source of hydrogen from biomass via gasification is discussed in Section 3.3.3.

The development of the fuel cell car and hydrogen as a major fuel can be secondary to the immediate need for hydrogen in the upgrading of heavy crude oil. The near term markets for hydrogen are in the transport of bio-oil to northeastern refineries where it could be converted to hydrogen and sold over the fence. Another important application is in the direct upgrading of products at the biorefinery.

#### *3.1.2.1 Refinery Feedstock*

The super case described in this report looks at the transport of bio-oil and dimethyl ether for the purpose of hydrogen production at refineries for upgrading the increasingly heavy feedstocks that are expected to be imported from Venezuela and Mexico. The climate change impact of upgrading these fuels is significant and the production of hydrogen from fossil sources can add significantly to the CO<sub>2</sub> emissions of the final gasoline product.

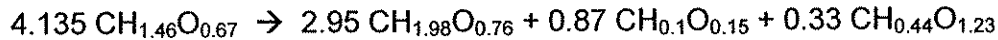
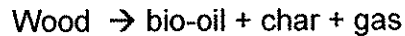
Refineries in the United States [CEH, 3.1.2(8)] produce and consume over three billion kg of hydrogen per year (.004 kg H<sub>2</sub>/kg crude) or approximately 0.5 kg H<sub>2</sub>/barrel of crude. The production of this much hydrogen from a carbon-based source produces over 20 million tons of carbon dioxide annually, which is about 1% of the amount of CO<sub>2</sub> that is produced when the oil is consumed. Therefore, a refinery that processes 200 thousand barrels per day has a hydrogen consumption of 36.5 million kg H<sub>2</sub>/year. If this were produced from bio-oil, it would require a wood feedstock supply of approximately 1200 tons/day, which is not an unreasonable match. This assumes a final hydrogen yield of 8 wt % which represents an energy efficiency of 50% (based on the lower heating value of the hydrogen and the initial dry wood).

Maine has no refinery operations but has access to several by way of sea transport and pipeline. Pipelines run up to the Montreal region. Petro-Canada has consolidated eastern Canada refining operations at its Montreal refinery. Shell also has a refinery in Montreal with a capacity of 130,000 barrels of crude daily. Both of these refineries will be producing low sulfur diesel fuel and therefore have an expanded need for hydrogen [REF].

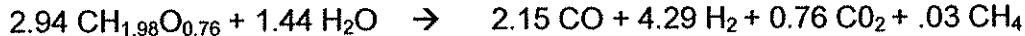
The northernmost refinery on the east coast is the ConocoPhillips Bayway Refinery with a capacity of 238,000 barrels per day of crude oil. This refinery is located in New York harbor and serves the markets of the Northeast Region. There is also a 775 million pound per year polypropylene plant on the site [REF].

Further south near Philadelphia is the Trainer Refinery on the Delaware River that has a crude oil capacity of 185,000 barrels per day [REF].

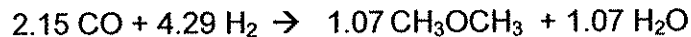
Bio-oil is produced by heating biomass to approximately 500 °C for several seconds and can be reasonably represented by the following reaction:



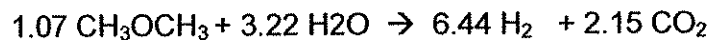
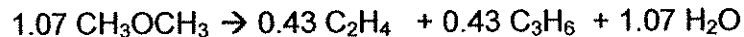
The bio-oil is produced in 78% yield, but as represented in this equation contains product water. It is assumed that the char and gas products are used for feedstock drying and process energy. The bio-oil is converted by catalytic steam gasification to syngas in appropriate H<sub>2</sub>/CO ratio for DME synthesis:



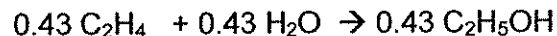
(Process energy requirements for gasification and DME synthesis are not addressed here). The syngas is then converted to DME in a yield of 49% based on the starting mass of wood (with some mass input from the water in steam gasification):



The DME can then be reacted over a zeolite catalyst to produce olefins such as ethylene and propylene or steam reformed to hydrogen:



The zeolite reaction yields a more complicated product slate than represented here. Although not used for fuel ethanol the catalytic hydration of ethylene is an important industrial method of ethanol preparation and could be an acceptable method of producing fuel ethanol if the ethylene is derived from renewable resources as proposed here:



The propylene (as well as any higher olefins) is a desirable product within the refinery and used in reformulated gasoline. Although much commodity polymer synthesis is located in the Gulf Coast Region, there is a polypropylene plant located in the New York Harbor area [REF].

From one regional pyrolysis plant with DME conversion, the following economic values could be derived from a 750 dry tons/day input assuming a feedstock cost of \$50 /dry ton:

- Feedstock value of \$13.5 million
- Bio-oil value of \$33 million assuming a value of \$0.10/lb
- Case 1, a combined value of \$57 million for the case where ethylene is converted to ethanol (assuming \$0.25/lb) and propylene is valued as a commodity chemical (\$0.30/lb)
- Case 2, a value of \$53 million/year for the conversion of DME to hydrogen at the refinery assuming a value of \$1.50/kg (reflects DOE targets for transportation fuel)

These ratios of product values to feedstock costs are promising if demonstrated to be technically feasible. Furthermore, these numbers could be potentially ten times greater if the integrated system as shown in **Figure 2** is deployed.

### 3.1.3 Fuel Blends

The fuel oil qualities of bio-oil was reviewed by Oasmaa and Czernik [3.1.3(10)] discussing the differences from conventional oil fuels and the physical and chemical characteristics relevant to fuel applications. Some relevant properties are contrasted with fuel oil in **Table 3.1**.

Bio-oil fractions for power generation have been used at Red Arrow Products in a 5 MW<sub>th</sub> burner system using a stainless steel nozzle and air atomization. Emission tests showed CO and NO<sub>x</sub> below the permitted level [Ref]. Gust [3.1.3(22)] described boiler tests in a 2.5 MW<sub>th</sub> boiler, used for a district heating application, in a dual fuel mode and reported acceptable results. Work at the Finnish Institute, VTT, concluded that minor modification to the burner was required to improve combustion.

Turbines are versatile and have high efficiencies compared to steam systems but need some modification to accommodate the physical and chemical properties of bio-oil. The questions of atomization combustion efficiency and soot formation are relevant to other bio-oil utilization processes as well, thus the studies of bio-oil for power are very important in evaluating other upgrading options. Czernik and Bridgwater [3.1(20)] point out that material considerations in turbines are also important because of erosion and corrosion of blades and the impact of acidity on storage systems.

Combustion in Diesel Engines has been demonstrated (see [3.1(20)] and references within for examples) and this is important for other thermal processing options because of the importance of combined heat and power (CHP) in maximizing efficiency and economics. This may be the most severe test of bio-oil to date and is highly relevant to other small-scale use options such as heating

oil replacement. The most recent work is by Ormrod Diesels [3.1.3(8)] with over 400 hr of operation using a dual fuel set up. Three cylinders of a 6 cylinder 250 kWe engine were modified to run on up to 95% bio-oil with diesel fuel as a pilot to initiate combustion.

Another approach for the use of bio-oil in conventional fuel oil streams is to form single phase emulsions between bio-oil and petroleum fuels. This concept has been successfully shown at CANMET (Canada Centre for Mineral and Energy Technology) [3.1.3(6)] and at the University of Florence [3.1.3(4)]. CANMET has a low cost proprietary surfactant which when added at 1 wt % of total adds \$.10/gal for a 10% bio-oil blend. This cost includes the additive and the power for forming the zero stratification emulsion. The deviation of physical and fuel properties of this blend from neat oil are negligible and thus represents a reasonable market entry strategy for bio-oil similar to the use of bio-diesel in the heating oil market in the Northeast. CANMET has a patent [3.1.3(14)], which describes the use of commercial surfactants and recent technical papers [3.1.3(6)], and bulletins [3.1.3(16)] describe proprietary surfactants derived from ricinoleic acid that has comparable performance with the commercial surfactants at one-third the cost. The BDM™ Process (Bio-Oil Diesel Mixture Fuel) is available for licensing [3.1.3(16)] and is a potential candidate for the No. 2 fuel oil market in the Northeast.

A semiautomatic 50 liter/hr emulsification system is in operation at the University of Florence [3.1.3(4), 3.2.3(12)]. Bio-emulsions have been tested successfully in small diesel engines at several places including Ormrod Diesels in the UK (see above). The goal of this work is to allow unmodified diesel engines to use a single blended fuel thus avoiding the costs associated with dual fuel use or modifications.

#### *3.1.3.1 Bio-Heat*

The market for home heating oil in the Northeast is significant. **Table 3.3** shows the market potential in the six New England states. The oil could be added by emulsification combined with some level of upgrading, such as acetalization (see 2.1.3). The advantage of this over a transportation fuel blend based on ethanol is that it can avoid the refinery infrastructure completely and therefore develop the core technology elements while methods are developed to interface with the refinery.

**Table 3.3: Bio-oil value by addition to home heating oil as a 10% blend**

	No. 2 Heating Oil 2001 million gal/year	Projected No.2 Heating Oil 2010 million gal/year	Bio-oil Potential, million gal/year @10% blend	Bio-oil Retail value @ \$10/GJ, million \$/year
CT	713.00	777.82	77.78	57.40
ME	413.00	450.55	45.05	33.25
MA	809.00	882.55	88.25	65.13
NH	223.00	243.27	24.33	17.95
RI	163.00	177.82	17.78	13.12
VT	113.00	123.27	12.33	9.10
<b>Total</b>	<b>2434.00</b>	<b>2655.27</b>	<b>265.53</b>	<b>195.96</b>

Source: EIA [3.0(2)]

The near term option is the blending of biodiesel with home heating oil. This blend, called Bio-Heat, is currently marketed around the United States. The most extensive testing program is run by the Warwick School Department in Rhode Island. During a one-year field test using various blends of biodiesel, results demonstrated were greatly successful. Currently, the school department is using a 20% biodiesel blend. The following companies are selling Bio-Heat [3.7.1(30)]

- Proulx Oil & Propane, Conway, NH
- People's Power & Light, RI

### 3.1.3.2 Diesel

The historical approach to renewable energy is that solar and wind can provide power but only biomass can provide a renewable source of carbon; thus, the focus for biomass should be on liquid fuels. In this strategy, in a future hydrogen-electric economy, that focus will shift to carbon based chemicals. The current push for ethanol has left only biodiesel to address the diesel market. Meanwhile the coal community sees Fischer Tropsch (FT) synthesis at scales of 5000 tons/day as a way of entering the liquid fuel market and plan on carbon sequestration to remove it from the environmental equation. These trends in ethanol, biodiesel and coal to liquids have support from constituents from important geographic areas and the corn and soybean industry [REF].

In the face of these market forces, the proposed strategy for bio-oil is to rely on heating oil replacement and stationary power generation to lay the foundation for entry into the diesel fuel market. This approach does not necessarily apply to gasification where FT diesel is a possibility, or fractionation, where ethyl levulinate is a potential diesel additive. In addition, it does not apply to tall oil derived fatty acids, which is an excellent niche project to catalyze the development of renewable additives to heating oil. However, in all other routes, the heating oil market can be entered without relying on a major refinery interface and the economic benefit to Maine will probably be greater since local companies

will produce, blend, and market the fuels. This is impossible for a transportation fuel without significant demonstration of performance.

In case P1, the concept of phenolic fraction hydrogenation is the most promising pyrolysis approach to entering the diesel market. Regulations of use of alternative fuels in vehicles needs investigation and the possibility that a diesel fraction from this pathway requires testing in stationary and fleet diesel engines would make an excellent proposal and attract the interest of energy companies.

### 3.2 Bio-Carbon

The production of charcoal is one of the oldest industrial processes tied to the beginning of metal processing.

Typically, the char is considered as the source of process energy for pyrolysis, which is a critical element of the conversion process. Nevertheless, the yield of char can be decreased if valuable products can be developed; the process energy can come from additional biomass. For example, activated carbon has an economical value of \$.30/lb where biomass is only \$.03/lb at \$60/dry ton. Therefore, process energy is no reason not to find routes to valuable products.

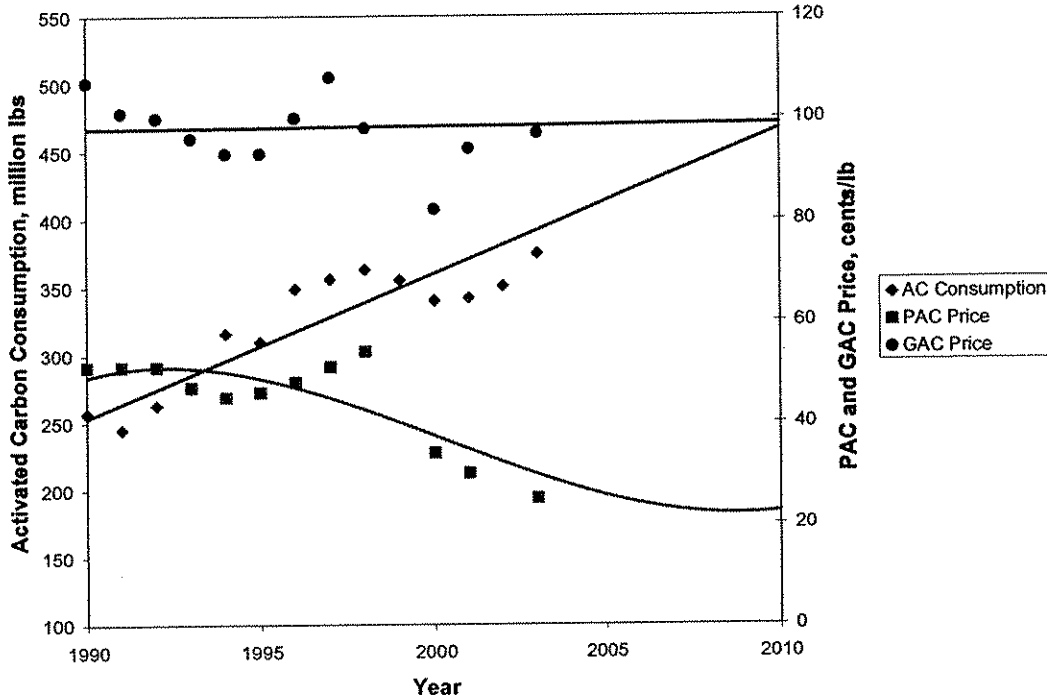
#### 3.2.1 Activated Carbon

Activated carbon (AC) is made by the partial oxidation of char typically with steam at 800 °C where half the carbon is removed as CO leaving a high surface area material typically with 700 – 1000 M<sup>2</sup>/gm of surface area.

The primary uses for activated carbon is for the clean up of liquid and gas streams. As any adsorbent, AC, works by attracting and holding contaminants on the surface with the nature of the adsorption controlled by chemical structure, due to starting material and processing conditions, and physical form such as particle size, pore size, surface area, density, and hardness [3.2.1(10)]. Activated carbon is sold as granulated and powdered forms with the granulated being approximately twice as valuable. Coconut charcoal is especially valuable for the granulated applications because of its hardness.

The largest liquid application is potable water where the annual use of AC is over 100 million pounds (37% of total). CEH predicts an annual growth of over 4% in the AC sector [3.2.1(6)]. Freedonia estimates AC demand to reach \$332 million in 2006 with future growth dependent on environmental regulations [3.2.1(4)]. Prediction of market and price are shown in **Figure 3.7** based on the historical market data.

The market will likely continue to increase at a linear rate based on increased population growth and environmental pressure for clean air and water. Increased imports will hold the price of powdered AC at or to less than half of its value five years ago while granulated AC (GAC) will hold flat at about \$1.00 /lb. Clearly, the production of substitutes for GAC is a more desirable market target and opens the door for the higher value gas phase applications.



**Figure 3.7:** Market and price projections for activated carbon [3.2.1(6)]

**Table 3.4** shows the major producers of activated carbon. There are no production facilities in New England. Calgon is the largest domestic producer and sells over 100 types of granulated powdered and pelletized activated carbon products as well as service applications [3.2.1(16)]. The market position of the major producers is to offer guaranteed and uninterrupted supplies assuring quality and environmental safety and health standards. Calgon facilities are ISO9002 certified and subscribe to the Chemical Manufacturers Association's Responsible Care Standards. In 2002 MeadWestvaco, another large AC manufacturer announced its partnership with Bioclimatic in an effort to expand into a vertical integration for market-based solutions for air purification [3.2.1(26)]. Norit is the world's largest producer of activated carbon with over 150 different product lines [3.2.1(28)].

**Table 3.4: Major Producers of Activated Carbon [3.2.1(32)]**

Producer	Capacity, x 10 <sup>6</sup> lb
Barnebey & Sutcliffe, Columbus OH	30
Calgon Carbon, Catlettsburg, KY	140
Calgon Carbon, Pearlington, MS	40
Norit Americas, Pryor, OK	35
Norit Americas, Marshall, TX	100
Royal Oak, Romeo, FL	20
Westvaco, Covington, VA	50
Westvaco, Wickliffe, KY	50
<i>Total</i>	465

The production of activated carbon is typically shown as a potential byproduct of biomass pyrolysis for fuel production, which could be done with greater efficiency because of heat and mass integration with other thermochemical operations such as gasification and reforming. However, there has been no significant commercial interest from the major companies (Table 3.2). The reasons for this may include:

- Relatively insignificant importance of feedstock cost (even at \$100/ ton for imported coconut shells to make high performance granulated carbon)
- The relative importance of coal as a feedstock where pore structure can be controlled by process conditions
- New international sources such as China
- Performance guarantees
- Excess capacity
- Emphasis on high performance systems

For these reasons, the addition of product from small scale systems is of little interest to current manufacturers.

The option proposed here is to anticipate the new markets that will utilize adsorbents in air and water cleanup and mitigate the application of agricultural chemicals when applied in environmentally sensitive areas. The goal is to define new business opportunities where the services are sold for these activities rather than selling the bulk commodity in a globally competitive market.

The first market is the biomass conversion plant itself that can use the adsorbents in air and water clean up and in the recovery of valuable products as in the case of solvent fractionation systems and solvent recovery. Other examples of in process applications are:

- Gasification tars removal from water after wet scrubbing
- Bio-oil aqueous fraction components concentrated for recovery of chemicals and then recovered with a solvent.



- Recovery of dilute high value biochemical products from bioprocessing streams
- Air emissions from combustion systems
- Catalyst supports
- Spill remediation (If Maine is going to move into major fuel production then products are required to assure environmental protection).

These process applications can be the initiation of materials for other test markets and fits within the "make a little; sell a little" philosophy. Local markets such as golf courses may be targeted for protecting riparian areas from the agricultural chemicals that are employed, such as fertilizers, herbicides and insecticides. The protection of drinking water from runoff contamination could be an important market as more demands for fresh water arise in the future. Municipal water treatment facilities are ubiquitous and water treatment chemicals are a growing market. Major companies such as Nalco, GE Water and Ashland Drew are contracting to manage the treatment steps in these facilities [3.2.1( )]. Discussions with these providers should be considered. Activated Carbon companies that now serve these markets are:

- Advanced Recovery Technologies Corp. in Michigan [3.2.1(14)]
- Everfilt Eastern Facility in Pennsylvania [3.2.1(20)]
- CPL Carbon Link in Ohio [3.2.1(18)]
- Envirotrol, Inc. in Pennsylvania [3.2.1(22)]
- Listings of other companies can be found at the web links given in [3.2.1(34); 3.2.1(50)].

Competing technologies for water purification such as reverse osmosis and ion exchange must also be considered as potential factors in the future market of adsorbents. Reactivation of spent carbon is also a growing business. US Filter operates two facilities in the Western United States [3.2.1(30)].

### 3.2.2 Fuel Pellets

Pellets fuels and appliances have many benefits over conventional wood heating if the consumer is buying wood. They are more convenient to operate, automated, and have higher efficiencies than ordinary wood stoves and have much better environmental performance [3.2.2(43)]. The Pellet Fuels Institute (PFI) established National Residential Pellet Fuel Standards in 1991 as shown in **Table 3.5** [3.2.2(103)]. The only disadvantage is that they require electricity to run the fan and feeder.

**Table 3.5: National Residential Pellet Fuel Standards [3.2.2(103)]**

<b>Pellet Fuel Standards<sup>1</sup></b>	<b>Premium Grade</b>	<b>Standard Grade</b>
Bulk Density/Cubic Ft.	Not less than 40 lbs.	Not less than 40 lbs.
Dimensions	Diameter ¼ inch to 5/16 inch	Diameter ¼ inch to 5/16 inch
Fines	Not more than 0.5% by weight Shall pass a 1/8 screen	Not more than 0.5% by weight Shall pass a 1/8 screen
Inorganic Ash	Less than 1%	Less than 3%
Length	None longer than 1.5 inches	None longer than 1.5 inches

The cost of wood pellet production in Austria and Sweden under several scenarios was reviewed by Thek and Obernberger [3.2.2(8)]. Assuming feedstock costs of approximately \$40/ton, the cost of pellet production was approximately \$105/ton or \$5.85/GJ. Home heating oil at \$2.25/gallon is equal to \$20.6/GJ. Therefore, there is tremendous potential for a pellet heating industry in the Northeast, especially if environmental regulations limit the use of conventional wood stoves. New England has the highest per capita wood stove ownership in the U. S. [(3.2.2(25)].

There are no pellet fuel manufacturers in Maine. The closest manufacturers are [3.2.2(31)]:

- **Lauzuan Recycled Wood Energy** (formerly Cubex Inc.), Papineauville, Quebec (330 miles from Rumford ME)
- **Energex Pellet Fuel Inc**, West Lac Megantic, Quebec Province Canada (123 miles from Rumford ME)
- **New England Wood Pellets**, Jaffrey NH (230 miles from Rumford)
- **Shaw Resources**, Shubernacadie, NS, CA (500 miles from Rumford ME, but possible sea shipment)
- **Fulghum Fibrefuels, Ltd.-MacTara Ltd** Upper Musquodoboit NS, CA (522 miles from Rumford ME)

Energex Pellet Fuel Inc. is the closest to Rumford and claims to operate the largest wood pellet plant in North America with an annual capacity of over 120,000 tons [3.2.2(55)]. Fulghum Fibrefuels Ltd., through its MacTara Ltd sawmill, supplies approximately 90,000 Mt of wood pellets to Helsingborg, Sweden [3.2.2(57), 3.2.2 (59)].

Pellets for domestic and industrial heating are a way to initiate biomass applications since the high value product is easily stored, metered and transported at both the production and consumption facilities. Integration with other thermochemical operations can have important synergies. Feedstock costs are 36% of the pellet manufacturing cost [3.2.2(18)]. Integration of pelletization with gasification allows materials that do not meet the specification for pellets to be used in the gasifier along with other residues. Drying costs are 28% of the

manufacturing costs [3.2.2(18)] and so heat integration with the gasifier will improve the overall energy efficiency of the combined operation. The third largest cost element of the pellet manufacturing is labor costs at 15% and job-sharing between the two operations is possible and will improve safety

Fuel pellet use in Europe has been growing steadily. Upper Austria has approximately 1.4 million inhabitants [3.2.2(61)] and renewable energy sources provide 30% of the primary energy consumptions (16% biomass). Both population and energy use is similar to Maine although the case in Austria is due more to policy, including a 20% subsidy for installation of a pellet heating system. Pellets contribute to more than 30% of biomass heating installation in new homes. The region also has pellet boiler manufacturers and an extensive network of businesses in renewable energy fields that together have 2,000 employees and a market of 215M Euros [3.2.2(8)].

An example of full size pellet fuel boiler manufacturer is Tarm USA [3.2.2(41)], that makes multi-fuel units (pellets, gas or oil) to heat homes up to 4000 ft<sup>2</sup> or 140,000 btu/hr and wood gasification boilers for up to 198,000 btu/hr.

There is some controversy over the expanded use of wood in any form for residential heating because of the increased air emissions even for pellets over a natural gas burner [3.3.3(67)].

### 3.2.3 Agricultural Chemicals

The use of biocarbons in this market are highly speculative and based on the idea that the large volume markets for agricultural chemicals can be accessed by the development of controlled release from biocarbons-derived adsorbents such as activated carbons. The concept is that fertilizers and pesticides could be bound to the carbon surface for controlled release and therefore be more environmentally acceptable. The only effort in this regard has been for the slow release of nitrogen by filling the char pore space with ammonium bicarbonate. The integration of this idea with the formation of ammonia since the biocarbon is produced at the same facility as hydrogen, which could then be used to synthesize ammonia. This topic was not investigated in detail as it was judged too conceptual and not likely for Maine to develop a strategic advantage over other geographical areas closer to the market, such as the Southeast and Midwest.

The idea for incorporating charcoal in the soil originates in part from the discovery of terra preta soils in the Amazon where the presence of charcoal in the soil from activities of people hundreds of years ago still makes these soils more fertile and able to withstand the extreme weathering and loss of nutrients that tropical soils undergo [3.2.3(12)]. This product area should be classified as

one of potential future interest given the near term markets for other biocarbon derived products

### 3.3 BioSynGas

The gasification of biomass has always been the nearest to commercial practice of the three major platforms analyzed in this study. The use of gasification for heat is practiced worldwide and can be integrated easily with the use of other fuels. The generation of power has been the main emphasis of new gasification technology development and has yet to make it to commercial deployment. The challenges are great because the value of power is low and the requirements for gas quality and reliability are high. THIS situation will remain for some time in Maine where the power production market is complex: the wholesale cost is low and the retail cost is high. Distributed power production for local consumption especially systems for combined heat and power and products is an approach that will have appeal where feedstock is available and power demands are high. This is also the best approach for maximizing efficiency, which must be the objective when developing a true biorefinery where power for the process and heat integration will always be required. In this section, we review the power option and then discuss the conversion of synthesis gas to products.

Approximately 6000 PJ/year of syngas is produced, or about 2% of the worldwide energy consumption [3.3(10)], for:

- Ammonia, 53%
- Refinery H<sub>2</sub>, 23%
- Methanol, 11%
- Electricity, 4%
- Gas to liquids, 8%.

Clean coal technology is based on Integrated Gasification Combined Cycle (IGCC) technology, which converts coal to a gas that can be cleaned of pollutants and allows the gas to be used in high efficiency gas turbines. Coal IGCC will always be large-scale installations and have economies of scale that will be difficult to achieve for biomass. For this reason, small-scale biomass to liquid fuel options will always be at an economic disadvantage compared to coal unless:

- A premium is placed on biomass derived fuels
- A carbon tax applied to fossil carbon operations
- The cost of carbon sequestration is included in the coal gasification cost.

Small-scale biomass gasification systems (hundreds of tons/day versus thousands of tons/day) may have a better niche when integrated with other conversion processes and with combined heat and power opportunities.

Spath and Dayton [3.3(16)] have published an excellent overview of bio-syngas conversion to fuels and chemicals including hydrogen, Fisher Tropsch Liquids, ammonia, methanol dimethyl ether, and acetic acid. Their analysis concluded that hydrogen has the best economic potential.

### 3.3.1 Power

Biomass power received a boost with the passage of the Public Utility Regulator Policy Act (PURPA) in 1978 [4.2.2.2(52)]. A biomass power industry was established in Maine as elsewhere in the U. S., but with deregulation and low natural gas prices nationwide in the 90's, the profitability of these plants was low, which reduced the time on stream and threatened the industry [3.3.1.1(14)]. That situation has changed in recent years with the proliferation of renewable portfolio standards (RPS). Green tags have been instrumental in reinvigorating the biopower industry in Maine. This is because of local programs [3.3.1(18)] such as Maine Interfaith Power & Light [3.3.1(10)] and the impact of selling green tags in Connecticut and Massachusetts. There are now approximately 11 plants up and running at capacity in Maine. GenPower is planning a new \$80 million 40 MWe plant at the Athens, Maine site with a start-up date of 2008. The plant will burn 350 thousand tons wood annually and employ 22 full-time workers [3.3.1(14)].

Borex, which is the largest producer of power from wastewood in North America, owns five facilities in Maine: a 50MW unit in Stratton and a 16 MW unit in Athens, as well as plants in Livermore Falls, Fort Fairfield and Ashland [3.3.1(6); 3.3.1.1(32)]. A review of Lessons Learned from Existing Biomass Power Plants [3.3.1.1(34)] included the Stratton plant, which is a traveling grate stoker boiler, brought online in 1989. The plant uses sawmill residues and chips (25%) as fuel and has a thermal efficiency of 25.3%, (higher heating value, HHV). In 1997, the plant had 33 employees and the original contract provided for 8.5 ¢/kWh but in the late 90's the price fell to 4 ¢/kWh.

The status of biopower in Maine has been recently assessed by Kingsley [3.3.1(12)] who concluded that the future holds promise but market uncertainties are inevitable. Much is tied to the stability of the RPS programs in the Northeast and the price paid for green tags.

The 2005 U. S. Energy Policy Act establishes a 1.8 ¢/kWh production tax credit for nine years if the states are on-line by the end of 2007. The Act also requires the federal government to buy at least 7.5% of its electricity for renewable sources and doubles the credit for power generated on site or on federal or tribal lands [4.2.2.2(98), 4.2.2.2(100)].

The key question is if biomass integrated gasification combined cycle (BIGCC) power systems is able to raise the efficiencies from the 25% level of combustion

systems to 40%. Questions of reliability and actual costs have prevented these technologies from going commercial. Many reviews have looked at the situation. The report by Craig and Mann [3.3.1(42)] on BIGCC compared several scales and technologies and found that the cost of electricity in a 40% efficient plant was 7¢/kWh (1996 \$) with a capital cost of \$1,400/kw.

These numbers do not present sufficient motivation for biopower investment in Maine in this technology especially since the program in Burlington, Vermont ended before a full BIGCC demonstration was achieved. This local example of gasification for power production was the demonstration at the McNeil generating station in Burlington, VT [3.3.1(4)]. The dual circulating bed gasifier at 200 tons/day was on the site of the largest utility-owned wood combustion plant (50MWe), which has been operating since 1984. The Vermont gasification project was the result of a cooperative agreement with Future Energy Resources Corp. (FERCO), DOE, and a utility consortium to scale up the Battelle Columbus Laboratories gasifier. Problems were encountered that prevented the long-term operation of the gasifier and the program was terminated before IGCC could be demonstrated.

A technically successful 6 MWe demonstration of BIGCC demonstration took place in Värnamo, Sweden using a pressurized circulating fluid bed gasifier. This demonstration covered all integrated elements of the technology and produced an additional 9 MW<sub>th</sub> to a district heating system. The demonstration ran successfully for 3600 hours. The plant has not run for several years because it was not economical at this scale but plans are in place to begin operations again in 2006 [3.3.1(46)]

### *3.3.1.1 Power Parks*

The focus of this topic is the bioenergy plant and related companies in a complex where heat and power and process steam can be sold across fences and used as a basis for other shared resources and integration opportunities. Community industrial complexes are well known, for example, district heating. One nearby location is Prince Edward Island, which has three district heating plants in Charlottetown built in the early 1980's. One plant burns municipal solid waste and provides steam to a hospital. A second plant uses woodchips to provide steam and hot water heat to downtown buildings and a third system is at the University of Prince Edward Island. The three systems are owned by Trigen-PEI, who consolidated the conversion system at the waste plant. The combined system heats 84 buildings and cools the hospital and the university. The customers pay a demand charge and an energy charge, which relates to the quantity of energy used and is tied to the price of oil. The complex substitutes 66,000 Mt of waste to displace 17 million liters of imported heating oil [3.3.1.1(6)].

A New England CHP workshop was held in Maine in 2000 to discuss the merits of combined heat and power [3.3.1.1(20)]. Recommended action items included the use of CHP at state facilities and eliminate incentives for utilities to deny CHP projects. In 2003 the Northeast CHP Application Center was formed and sponsored by DOE, the University of Massachusetts, Pace University, New York State Energy Research, and Development authority (NYSERDA), MA Division of Energy Resources, and the Maine State Energy Office [3.3.1.1 (44)].

The power park concept can be extended to hydrogen production and use, which is being studied from a range of renewable options, such as photovoltaics, [3.3.1.1(12)] and natural gas. Such systems could be applied to biomass-fueled systems as well where power is produced as needed and off peak capacity can then be used to make and store hydrogen for fuel. For biomass, the waste heat can be used for heat and cooling or process steam.

### 3.3.2 Thermochemical Ethanol

The topic of ethanol is covered twice in this report under thermochemical ethanol and under 3.6.4. The general market information is presented here and only the specifics of the biochemical route ethanol in 3.6.4.

Ethanol has come of age in recent years. In 2004 it gained commodity status with the New York Board of Trade, which introduced a futures contract for sugar derived ethanol and the Chicago Board of Trade for corn based ethanol [3.3.2(60)]. The futures should help stabilize price spikes caused by corn do corn prices fluctuate and fuel ethanol price fluctuations. The feedstock variability is because the yield is dependent on weather and that is not the case for forest product derived feedstock as is possible in a thermochemical ethanol process.

#### *3.3.2.1 The Ethanol Market in the Northeast*

A ban on MTBE went into effect in early 2004 in New York and Connecticut; ethanol now replaces MTBE as the required oxygenate in reformulated gasoline. Other New England states may enact a similar prohibition [3.3.2(78)]. The main impact of this ban is on the reformulation of the gasoline to meet specifications with the ethanol blend. The 1990 Clean Air Act and related regulations require that reformulated gasoline be sold in non-attainment areas such as New York City and contain 2.0% oxygen by weight, which means it must contain 5.75% ethanol [4.2.2.2(62)].

Other market factors are a renewable fuel standard (RFS). The 2005 Energy Act establishes a RFS of 5 billion gallons in the market by 2010 or about 3.5% of the total annual gasoline market in the U. S. [3.0(60)]. The Energy Act also bans the use of MTBE by 2014. A third factor is the recent steady increase in petroleum

cost making the use of ethanol more economical. If it is assumed that the market penetration of ethanol in the Northeast will be consistent with the 2005 Energy Act requirements for 2010 then an estimate can be made of the fuel ethanol market and those results are shown in **Table 3.6**.

**Table 3.6:** Estimates of potential ethanol market in the Northeast based on a 3.5% addition level

	Gasoline 2001 billion gal/year <sup>1</sup>	Projected Gasoline 2010 billion gal/year <sup>2</sup>	ETOH Potential, million gal/year <sup>3</sup>	Retail value, million \$/year <sup>4</sup>
NJ	3.94	4.30	150.44	203.09
NY	5.62	6.13	214.58	289.69
PA	5.07	5.53	193.58	261.34
CT	1.50	1.64	57.27	77.32
ME	0.58	0.63	22.15	29.90
MA	2.74	2.99	104.62	141.23
NH	0.69	0.75	26.35	35.57
RI	0.40	0.44	15.27	20.62
VT	0.33	0.36	12.60	17.01
<b>Total</b>	<b>20.87</b>	<b>22.77</b>	<b>796.85</b>	<b>1075.75</b>

The gasoline supply and distribution system in the northeast is complex and depends on pipeline supply from the Gulf Coast, Mid-Atlantic refineries and imported gasoline. In 2004, the CONEG (Coalition of Northeastern Governors) Policy Research Center thoroughly studied this issue in preparation for the replacement of MTBE with ethanol in New York and Connecticut [3.3.2(78)]. The region is served by approximately 150 product terminals. Ethanol will have to be blended at each of these terminal points if they are all to contain ethanol. The current laws require RFG in non-attainment areas with some bordering areas choosing to use RFG since most of the product terminals are within non-attainment areas [REF]. The complexity of this system is a potential barrier to biomass integration because of the impact of potential supply disruptions.

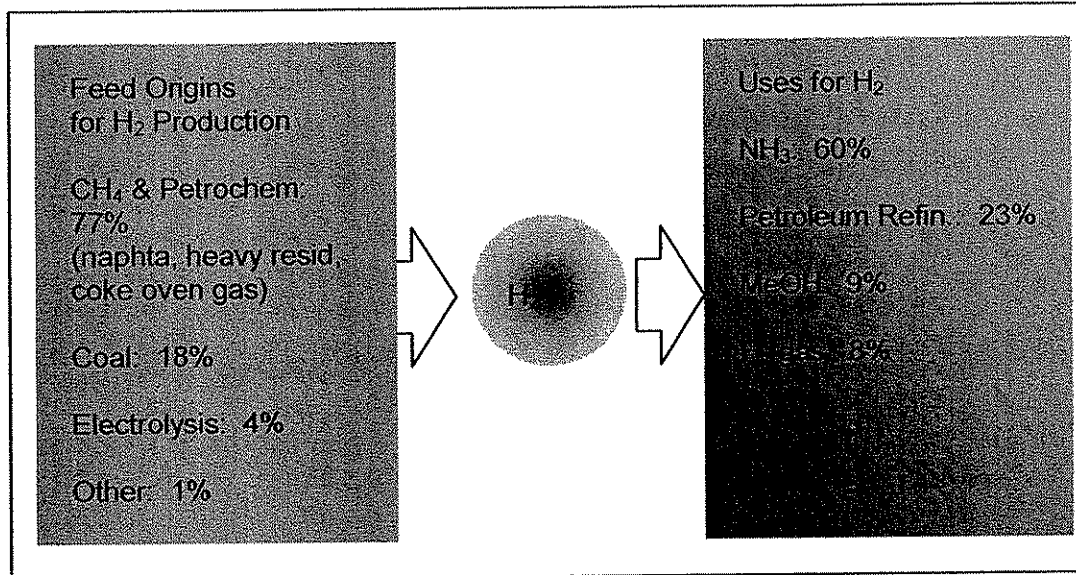
Another approach to ethanol is the P-Series fuel developed by Princeton University and now deployed by Pure Energy Corporation (see section 3.4.2.2), which is a blend of light hydrocarbons, methyltetrahydrofuran and ethanol. There was much publicity for this concept in the late nineties including a demonstration in Philadelphia [REF]. The status of this work is uncertain.

Pure Energy Corporation has also developed a system for solubilizing ethanol in diesel fuel called Puranol, which utilizes solubilizing agents derived from fatty alcohols. The additive gives a single phase system that does not rely on stable emulsification to obtain a blend that is stable to changes in temperature and storage time [3.3.2(18, 24, 26)]. This could also be applied to heating oil and allow similar benefits of substituting renewable resources into this important Maine market.



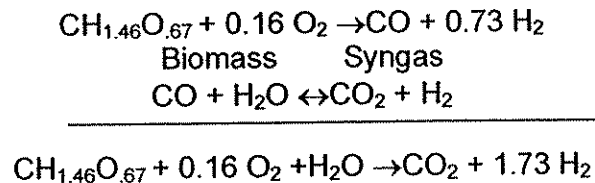
### 3.3.3 Hydrogen

Hydrogen production is the largest use of syngas today and is produced by the steam reforming of methane.



**Figure 3.8:** Current hydrogen production sources and markets [Appendix 2]

Oxygen or air gasification followed by water-gas shift is the simplest way of producing hydrogen from biomass. Based on the following reactions and typical composition for biomass:



the stoichiometric yield of hydrogen produced by partial oxidation is 14.3 wt %. Practical yields are lower because in reality a small percentage of biomass carbon is converted in the first phase to char, tar, and CO<sub>2</sub> resulting in less CO available for production of hydrogen by the second-phase water-gas shift. For example, the Renugas Process developed by the Gas Technology Institute (formerly the Institute of Gas Technology) [Evans et al, 1998a [REF]] generates 0.31 Nm<sup>3</sup> of hydrogen from 1 kg of wood. Assuming that other gas components such as carbon monoxide, methane, and other hydrocarbons could be converted to CO<sub>2</sub> and hydrogen, the hydrogen production would increase to 1.19 Nm<sup>3</sup>, which corresponds to a total yield of 10.7 wt %. An advantage of oxygen or air gasification is that it does not require any external source of energy since the partial oxidation reactions are exothermic.

Higher yields of hydrogen (theoretically 17%, see section 2.3.3) can be obtained by steam gasification of biomass [Hofbauer et al, 2001], but this is a highly endothermic process that produces significant amount of hydrocarbons, which must be catalytically reformed before the water-gas shift stage.

The markets for hydrogen are discussed in section 3.1.2.

### 3.3.4 Dimethyl Ether

A recent publication by Semelsberger et al [3.3.3.4(40)] proposes that DME has the "largest potential impact on society and should be considered as the fuel of choice for eliminating the dependency on petroleum." There has been a long time interest in DME, but like hydrogen, the historically cheap and available fossil fuels have limited investment in new infrastructure given the barriers and risk for the investment that needs to be made in the transportation sector. The position taken in this study is that **DME can serve as an enabler of biomass by its use as an intermediate for conventional fuels and eventually for hydrogen production as well as the possibility of its use as a major energy carrier.**

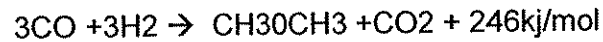
DME has a normal boiling point of -24.9 °C, which is comparable to propane at -44.5 °C and has the same safety precautions since it is heavier than air it will accumulate in low lying spaces. The flammability limits are 3.0-16.6% [Parent, A4-1]. Unlike other organic ethers, it does not form unstable peroxides and is non-toxic and environmentally benign. The current commercial use of DME is limited; it is used for the production of the methylating agent dimethyl sulfate and as an aerosol propellant.

The International DME Association [Parent A4-8] has published a review of DME properties and applications. The target market is that of Liquefied Petroleum Gas (LPG), which is a mixture of propane (50-70%), and Butane (30-50%). DME has been proposed as a substitute for diesel because of its low auto-ignition temperature and a Cetane Number of 55 compared to 45 for diesel. The low boiling point improves combustion and cold start properties.

The major thrust for DME as a fuel is in Asia and Iran with large new production facilities under construction [REF]. Emphasis is on use as a substitute fuel for cook stoves. It has also been investigated as a gas turbine fuel. Eventually DME could be used in fuel cells avoiding some of the problems associated with direct methanol fuel cells.

DME is made from the dehydration of methanol in a two-step process. New studies suggest a process that can take syngas to DME in a single step [Parent, A4-11] and demonstrated at a pilot scale plant of 5 tons/day [Parent A4-12].

The company, JFE uses this approach of direct DME synthesis is to combine methanol synthesis and dehydration with water-gas shift, so the overall reaction is:



The consumption of methanol and water pushes the reaction to the right and results in conversions of over 80% at a pressure of 5MPa (750psi) [Parent A4-12]. Since the reaction is highly exothermic, it is carried out in a liquid phase slurry reactor for heat removal and with a proprietary catalyst.

### 3.3.5 Fischer Tropsch Liquids

Fischer Tropsch Liquids (FTL) are hydrocarbons produced from syngas over transition metal catalysts as shown in **Figure 2.x [From Yves report, goes in section 2]**. The use of this technology occurred in Germany during World War II and in South Africa since 1955 [Appendix 2]. The product distribution is a function of catalyst and conditions and management of heat produced in the reaction make this a technology, which is better performed at large scale.

The two major catalysts are:

- Iron, which has a short life but is low cost and can tolerate a wide range of  $\text{H}_2/\text{CO}$  because it also has water gas shift activity and so also produces byproduct  $\text{CO}_2$  in addition to water. The products are more olefinic and have a higher molecular weight distribution.
- Cobalt, has a longer life but is more expensive and requires the  $\text{H}_2/\text{CO}$  to be 2, the product is more paraffinic, and has a lower molecular weight distribution [Parent A2-4].

The current technology providers in the U. S. are:

- Rentech, Slurry Reactor and iron catalyst. Rentech has a joint venture to convert a methanol plant in Denver to be the first gas-to-liquids plant in the U. S. at 800 bbl/day of product. Rentech chose a slurry reactor and iron catalyst for the lowest cost and a flexible process to cover a range of feedstocks including stranded natural gas and coal gasification.
- Shell, Fixed Bed Reactor using the cobalt catalyst
- Exxon, Slurry Reactor using a cobalt catalyst
- Sasol, Slurry Reactor using both cobalt and iron catalysts
- Syntroleum, Fixed Bed using a cobalt catalyst [Parent A2-3].

There is much activity in Fischer Tropsch synthesis around the world and this technology can be considered commercially ready when the market justifies the expense. Besides the technology driver and the increasing value of the product as crude oil prices rise, a third factor is the new market for low sulfur diesel.

The area of interest for Maine is once again home heating oil if production could be centralized at a large-scale facility.

### 3.3.6 Ethylene

The steam cracking of hydrocarbons accounts for the bulk of the ethylene produced worldwide. The furnaces represent 25-35% of installed costs. Most of the plants in the United States are located on the Gulf coast and hence most of the upstream chemical operations are located there. The largest producers are Dow, ExxonMobil, and Shell [3.3.6(6)]. The demand in 2006 is expected to be 64 billion pounds and the market is expected to grow at 2 percent per year. Current prices are at a historic high and expected to be around \$0.30/lb for the near future due to high natural gas prices [REF].

The major uses of ethylene are for polyethylene synthesis (54%), ethylene dichloride (18%), ethylene oxide (12%), and alpha-olefins (8.5%). The use envisioned in Maine is to convert it to ethanol assuming that if derived from biomass it will qualify for tax credits. The alpha olefin synthesis is a fast growing area. The ethylene is oligomerized to produce linear alpha olefins and alcohols of various chain lengths from C<sub>4</sub> to C<sub>18</sub>, which are used for drilling fluids, co-monomers in polyethylene, synthetic lubricants, derivatives with succinic anhydrides, plasticizer, and detergents. The market for these products is growing at 4.5 %. Export market is expected to decline because of the cheaper natural gas prices and growing capacity in the Middle East [3.3.6(4)].

The US is likely to follow the market trend in Europe where although globally uncompetitive, the existing industrial infrastructure and a large local market provides opportunity. The path in Maine will have to be different than the more established and industrial regions of the US by making ethylene as a captive product that complements other bio-derived chemicals that can be used in the development of fuels and high performance materials, such as the reaction with succinic acid.

### 3.3.7 Propylene

Unlike ethylene, propylene is used for both chemical and fuels processing. Approximately 45 million pounds of propylene are produced for chemical applications in North America [3.3.7(4)]. The largest producer in the world is Exxon Mobil and in North America, it is Equistar. Approximately 50% goes to polypropylene with less than 10% each going to acrylonitrile, oxo chemicals, propylene oxide, and cumene. Propylene is primarily a byproduct of ethylene production and most of the remainder is produced at refineries because of cat cracking REF

One relevant use is the reaction of propylene with carbon monoxide to give oxo chemicals. It can also be hydrated to form isopropyl alcohol. The old technology

for polymer gasoline where propylene is oligomerized over a phosphoric acid catalyst to form dimers, trimers, and tetramers. Polypropylene is the fastest growing commodity thermoplastics and unlike polyethylene, there are production facilities in the Northeast.

The use of propylene in the refinery is primarily in alkylation, where propylene and butylenes are reacted with isobutane to form hydrocarbons with high octane ratings.

The average annual growth rate for propylene is expected to be over 3%. The market price has increased like ethylene and now is about \$0.40/pound compare to the historic price in this decade of closer to \$0.20/lb [REF]

### *3.3.8 Reformulated Gasoline*

Reformulated Gasoline (RFG) is the result of Clean Air Act amendments in the 1990s to reduce ozone in non-attainment areas by eliminating volatile organic compounds (VOC) from emissions associated with the automobile [REF]. This includes vapor losses during fueling, evaporative losses from the fuel system while the vehicle is standing or running, and VOC in the exhaust. The baseline for regulation for emissions from automobiles changed in 1998 from the simple model to the complex model to calculate emissions of volatile organic compounds (VOC), toxic air pollutants (TAP) and nitrogen oxides (NOx). The major difference is that rather than use a generalized baseline each refinery will have to meet individual targets making the requirements stricter for some refineries [REF]. Reformulated Gasoline (RFG) must contain:

- An average 2.1 wt% oxygen (varies with area and from summer to winter; and not to be confused with the oxygenate program for CO non-attainment areas)
- Benzene levels must be less than 1 vol %.
- Total aromatic content is limited by relevant model for each refiner
- Sulfur and olefin content must not increase beyond the 1990 baseline
- No heavy metals

In general, the reformulated gasoline program should be a positive market force for a northeast biorefinery. The program has been criticized as not producing any benefit, especially the oxygen content requirement. The ban on MTBE is a challenge to the RFG requirement for both oxygen addition and octane enhancement. The prospects of a new oxygenate being used is never seriously discussed so ethanol appears to be the only realistic option and despite the controversy about its use there is little political chance to repeal the ethanol content.

### 3.4 Cellulose

The production of cellulose by fractionation of wood as shown in **Figure 2.5** has the option of marketing as pulp, modification to cellulosic fiber and further conversion to fuels and chemicals. The latter path is the main thrust of fractionation efforts for the production of the higher value products with the potential for large market development [3.4(10)]. Cellulose is the most common natural polymer and as a separated constituent of wood used for paper products and from cotton for textiles, either in its natural form or derivatized as cellulosic fiber or blended with synthetic polymers such as polyester [REF]. These markets are huge, but threatened by international market forces.

The further conversion to potential commodity chemicals is discussed here in the context of levulinic acid and its derivatives. This has been a major thrust of DOE -sponsored research leading to potential derivatives for the fuel market including ethyllevulinate and methyltetrahydrofuran. The more common path is the use of the separated cellulose for the conversion to the intermediate sugar platform where over 25 leading building blocks products can be considered for further upgrading [REF].

#### 3.4.1 Fiber

The cellulose produced by fractionation has the potential to replace conventional wood pulp with utilization of the lignin and hemicellulose fractions for products and with less environmental impact. Some of the major fractionation technologies, such as steam explosion and organosolv [REF], have been around for many years, but widespread commercial development has not taken place for fiber production. The current worldwide average market value of bleached softwood kraft pulp in North America is \$340/ air dried metric ton (~\$0.20/lb (dry)) and bleached hardwood kraft pulp is \$250/air dried metric ton (~\$0.20/lb (dry)) [McNutt 3.4.1(4)]. If the fiber can be sold into this market then it will be a competitive target product. This will be determined by process economics and fiber quality, both of which are likely to be perceived as real barriers to market entry.

A more likely match is the use of the separated cellulose for the production of cellulosic fibers where a fraction of the hydroxyl groups is replaced with substituents such as acetate groups. The price for chemical grade cellulose is twice that of pulp grade and the market has been historically large. However, the disappearance of the North American capacity and market has been dramatic, decreasing from a high of 280,000 metric tons in 1986 to 81,000 in 2002 [3.4.1(4)]. China has shown the most significant growth from 183,000 to 682,000 metric tons per year over the same period. Western Europe production has held relatively constant over this period, even while Eastern European levels have

fallen significantly. It appears that the synthetic textile market in the United States holds little promise for Maine bioproducts.

Pure Vision Corp of Colorado [2.3(29)] has announced a partnership with International Paper (IP) which was awarded a DOE funded project to develop their fractionation technology for the production of fiber as well as chemical feedstocks. Early work focused on wheat straw, but the IP work will focus on loblolly pine to process paper products.

### 3.4.2 Levulinic Acid

Levulinic Acid (LA),  $C_5H_{10}O$ , has limited market applications at present primarily because of its high cost. It is sold commercially by DSM Chemicals [3.4.2(6)]. The production from biomass could change that and Biofine Inc, NREL and Pacific Northwest National Laboratory (PNNL) have teamed up over the last decade to develop this concept. The center of this activity has been Biofine Inc., which has a pilot plant in South Glens Falls, New York and a patent on a dilute acid high temperature hydrolysis process. Precise control of temperature and residence times in two stages of hydrolysis is used to optimize the yield of LA. The pilot plant has run on paper mill sludge at about a ton/day of input [3.4.2(8), 3.4.2(12)].

The relative performance of different feedstocks has not been published and claims for paper mill sludge, MSW, agricultural residues and other lignocellulosic streams have been made as target feedstocks. It is unclear how well the process can work for whole wood since it would share the same challenges of any dilute acid pretreatment step. Most fractionation approaches have settled on agricultural residues such as corn stover or wheat straw.

Data on economics and market analysis for levulinic acid (LA) was summarized by McArthur and Frolich [3.0(40)] in a University of Nevada, Reno review with reference to the work of Biofine Inc. They reported difficulty in assigning market prices for the products. Fitzpatrick states that the critical price for LA in the production of the high value product diphenolic acid as \$1.50/lb, but only \$.10/lb if the market is gasoline additives such as MTHF (see section 3.4.2.2). The other products produced are formic acid and furfural, neither a marketable commodity in the United States. The current LA market is about one million pounds per year at a cost of \$4-6/pound [3.4.2(18)].

#### *3.4.2.1 Ethyl Levulinate*

### 3.4.2.2 Methyltetrahydrofuran

Methyltetrahydrofuran (MTHF),  $C_5H_{10}O$ , is a clear liquid with a boiling point of 80 °C and a molecular weight of 86 [3.4.2.2(10)]. MTHF is 18.6% oxygen by weight; thus it is a potential RFG additive. It is marginally soluble in water (15 g/100 mg) and so must be compared to MTBE and the trouble caused by water contamination. MTHF may form peroxides during storage and if concentrated (e.g., by distillation of the MTHF) they can be a potential explosion hazard. This is a potential production hazard, which can be easily managed by the addition of stabilizers and should not be a problem with its use in blended gasoline.

The P-series fuel is composed of a mixture of light hydrocarbons, ethanol, and methyltetrahydrofuran (MTHF) which was patented by Stephen Paul from Princeton NJ in the mid 90's [3.4.2.2(4)]. The patent claims that a range of mixtures can be used as a direct substitute for gasoline with no engine or infrastructure modifications. The idea of utilizing MTHF by Paul was apparently derived from the work of Biofine who cited MTHF as a levulinic acid derived product. Some work occurred in Florida in the 1980s to form MTHF from LA; specifically as a fuel blending agent [references cited in 3.4.2.2(6)]. Pure Energy Corporation (PEC) [3.4.2.2(8)] who also market or markets additive packages for blending ethanol with diesel now holds the rights to the Paul patent. In 1999, PEC announced a plan to manufacture P-series after pilot plant trials at the Tennessee Valley Authority in Alabama and at Arkenol in California.

Elliott patented a one step process for hydrogenating LA to MTHF in 90 mol % yield with less than 10% byproduct which is primarily 1-pentanol [3.4.2.2(6)]. This work was sponsored by DOE as part of an integrated LA program, which also included the production of delta amino LA (DALA) for use as a pesticide.

## 3.5 Lignin

Lignin means one thing to the wood scientist who studies its biochemistry, structure, and function in the cell wall, and another to the industrialist who views it as a commercial product after it is removed in pulping. The two materials are significantly different. Commercial lignins are of several types depending on the pulping process. The two main commercial varieties are kraft pulp and lignosulfonates, produced by kraft and sulfite pulping, respectively. The other types of separated lignins that are commonly studied are:

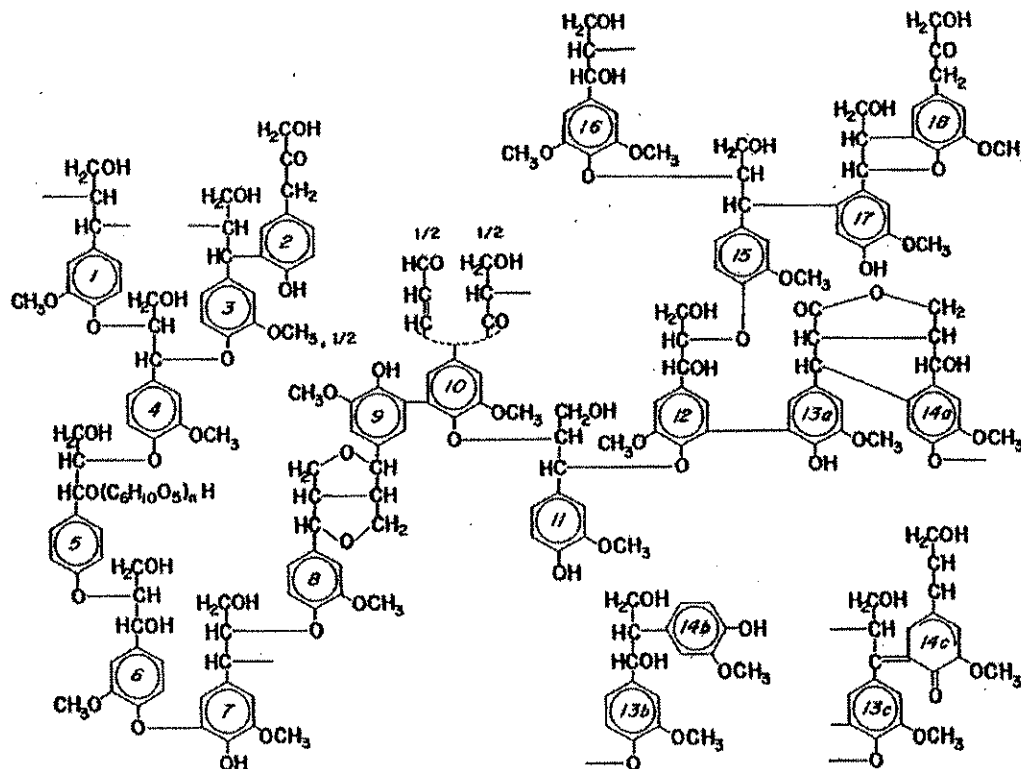
- Ball-milled Lignin, which is removed by mild extraction with organic solvents while ball-milling wood, is considered to be the best representation of native lignin [REF]
- Klason Lignin, which is separated by acid hydrolysis and used for quantitative estimates of the lignin content of biomass, however, the resulting lignin is severely degraded by the treatment [REF]



- Steam Explosion Lignin, which is extracted from the wood fiber after thermal treatment and is a leading candidate for chemical conversion [REF]
- Organosolv Lignin, is solubilized during the solvolysis process and hence is perhaps the least degraded lignin with commercial potential [REF].

Most lignin is burned for energy and chemical recovery during pulping operations. Both scientists and industrialists recognize **Lignin's intrinsic chemical value**, thus the quest to separate and derive value from the structure has been and is one of the grand challenges of biomass conversion.

The biosynthesis of lignin starts with three precursor methoxy phenols: the monomethoxy coniferyl alcohol found in softwoods, the dimethoxy syringyl alcohol found in hardwoods along with the latter, and coumaryl alcohol found in grasses along with the latter two. **Figure 3.9** shows the classic Freudenberg model of softwood lignin.



**Figure 3.9:** Conceptual model of the structure of a softwood lignin showing the predominant linkages of the coniferyl alcohol building block [REF]

The alpha carbon on ring 5 is shown linked to a hemicellulose carbohydrate and the key to liberating the lignin is the breaking of this bond, typically with acid or base catalysts, stabilizing the structure by end capping with sulfur or extracting

into solvent, and then removing the lignin in a soluble form. This action done at elevated temperature changes the lignin from its native structure, typically affecting the molecular weight and structure. These changes do not make the lignin more amenable to depolymerization, or to selective conversion to a monomeric building block of value, such as phenol or anisole [REF].

In the case of pyrolytic lignin (section 3.1.1), the mixture of compounds includes monomeric units with a variety of side chain structures as well as higher molecular weight products. For the fractionation-derived lignin, we can assume some modification of the structure shown in **Figure 3.8** primarily in the side chain structure.

### *3.5.1 Oxy-Aromatics*

Shabtai and colleagues at the University of Utah in partnership with NREL have done the principal research in the conversion of lignin to fuel additives [3.5.2(22)]. The initial process is a two-stage conversion where stage 1 is base-catalyzed depolymerization (BCD) followed by hydrotreating to yield hydrocarbons composed of C7- C10 alkylbenzenes (75-90 wt% with the balance being other hydrocarbons). In a second two-stage process, mild BCD and mild hydrocracking followed by catalytic etherification with methanol generates aromatic ethers.

## **3.6 Sugars**

### 3.6.1 Xylitol

Xylitol is a five-carbon sugar alcohol made by the reduction of xylose just as sorbitol is a 6-carbon sugar alcohol made from glucose. It is of interest to the food industry because (1) it does not promote cavities unlike sorbitol, and (2) it has no insulin response. It is for this latter reason that a large upswing in its market could occur and allow new producers to enter the field. Another medical benefit may be the promotion of calcium uptake in tooth enamel and by adsorption in the intestine via a complex with calcium [3.6.1(2)]. Studies have also shown a decrease in ear infections when xylitol is administered orally [3.6.1(16)].

The current market is \$28 million and sells for \$3 per pound [3.6.1(22)]. The field now is dominated by Xyrofin in Finland using hydrogenation technology and chromatography to separate the xylitol and crystallization for purification [3.6.1(34)]. The Danish firm Danisco is the biggest supplier in Asia and projects

a growth rate of 2.7% for the next five years to reach a market of 1.6 million Mt [3.6.1(24)].

An alternative approach proposed here is to use microbial fermentation, which is not currently practiced commercially, and hence may provide a technology niche when linked to the appropriate fractionation technology. USDA researchers at the National Center for Agricultural Utilization Research in Peoria, IL are working with the yeast *Candida peltata*, to ferment the xylose in corn hydrolyzate to xylitol [3.6.1(22)].

Xethanol Corporation headquarter in New York is a biomass-to-ethanol company with two facilities in Iowa [3.6.1(18)]. The company recently acquired a license to the NREL clean fractionation technology for integration with their processes for producing ethanol and xylitol. Recently, Xethanol entered into a cooperative agreement with the USDA Forest Products Laboratory to develop yeast strains for xylitol production [3.6.1(20)]. Xylose Technologies Inc., a subsidiary of Xethanol, has purchased the license, but the terms of the license are not for trees, hence an opportunity for a similar approach could be adopted in Maine.

Xlear Inc of Utah is one of the leading manufactures of xylitol products including sweeteners, dental products, and nasal washes [3.6.1(16)]. Tom's of Maine markets oral care products with xylitol [3.6.1(12)]. Thus, a potential niche may be part of the overall approach for development.

### 3.6.2 Lactic Acid

### 3.6.3 Propane Diol

### 3.6.4 Ethanol

The most developed example of cellulose-derived ethanol is the production from wheat straw by Iogen, an industrial enzyme company that develops enzymes for the fiber industry. Iogen operates the only cellulose ethanol demonstration-scale facility in the world. Recently, Iogen, Shell and Volkswagen announced that the three companies will conduct a joint study to assess the feasibility of producing cellulose ethanol in Germany [3.6.4(40)].

### 3.6.5 Furfural

Furfural,  $C_5H_4O_2$ , is a viscous liquid with a boiling point of around 160 °C although, susceptible to polymerization reactions while vaporizing. It has a molecular weight of 96 [3.6.5(8)].

Furfural is produced commercially by the acid catalyzed dehydration of pentosan-containing agricultural residues, such as corncobs, oat hulls, and sugar cane bagasse. The worldwide market is greater than 280,000 tons/year [3.5.2(22)]

The major commercial application of furfural is as a starting material for production of furfuryl alcohol, which in turn is used for furan thermoset polymers. Another use for Furfural is as a solvent for refining lubricating oils and other chemicals. With a higher density than petroleum, Furfural can be used in a counter current flow reactor to extract the aromatics from paraffinic oil. Other uses for furfural are as a solvent for cellulose acetate and a starting material for tetrahydrofuran production. Furfural has some recent use in agriculture as a nematicide with a potentially large worldwide market [3.6.5(20)]. This initiative centered in South Africa where Illova Sugar has marketed a furfural based product, Crop Guard, for the control of nematodes in the soil. They claim the world market for nematicides is \$35 billion worldwide [3.6.5(26)].

The trend in the U. S. in the last 10 years has been to close down plants because of international competition. Production has dropped from 125 million pounds in 1980 to only 12 in 2003 [3.6.5(6)]. China is believed to be the largest producer of furfural at 300 million pounds and able to produce it at a third the historical cost of approximately \$0.75/lb [3.6.5(6)].

#### 3.6.5.1 Methylfuran

The production of methylfuran from furfural has been demonstrated over zeolites catalysts in the presence of methanol. Engine studies have found it to be an effective structure with regard to ignition quality, and it has a high octane number and oxygen content so there is a potential market for it as a gasoline blending agent. Hydrogenation could take it to methyltetrahydrofuran as well although no reports were found in the literature [REF].

### 3.7 Extractives and Tall Oil

Some representative extractive compositions of softwoods and hardwoods are given in **Table 3.7** [REF]. The total acetone extract contains both polar and nonpolar compounds; the material that is insoluble in ethyl ether is probably carbohydrates that were soluble in the more polar acetone. The amount soluble in ethyl ether is further fractionated in petroleum ether where the soluble fraction contains the free fatty acids, the resin acids, and the neutral fraction. The latter is composed of lipids such as triglycerides and hydrocarbon such as sterols.

Representatives of these materials are discussed here. As shown in Table 3.7, the acetone soluble extractives for softwood differ primarily from hardwoods by the presence of rosin acids, which are derived from terpenes, and are described in the following sections

Crude whole tall oil (CTO) is a mixture of rosin acids (~40%), fatty acids (~50%), and sterols (~10%). It is obtained by treating black liquor soap skimmings recovered from the kraft process with sulfuric acid. The composition of crude CTO varies widely and depends on the type and location of tree and the treatment of the logs. Industrial uses of the CTO include drilling muds and ore flotation. There is an increased demand for the separated tall oil fatty acids, which can be separated by fractional distillation to provide rosin and fatty acid fractions [REF]. This is not practiced in Maine paper mills but is common in the south. The major producers are shown in Table 3.8

**Table 3.7:** Extractive composition of illustrative hardwoods and softwoods [1.3(25)]

	<i>Picea abies</i> Spruce	<i>Pinus sylvestris</i> Pine	<i>Betula verrucosa</i> Birch	<i>Populus tremula</i> Aspen
Acetone extract <sup>1</sup>	2.2	3.1	3.5	4.5
EE <sup>1</sup> insoluble <sup>2</sup>	1.0	0.7	1.4	2.0
EE <sup>1</sup> soluble <sup>2</sup>	1.2	2.4	2.0	2.3
PE <sup>3</sup> insoluble <sup>2</sup>	0.2	0.1	0.0	0.0
PE <sup>3</sup> soluble <sup>2</sup>	1.0	2.3	2.0	2.3
Free fatty acids <sup>4</sup>	7.5	7.6	0.0	4.7
Resin acids <sup>4</sup>	27.4	29.0	0.3	0.8
<b>Neutrals<sup>4</sup></b>	<b>62.1</b>	<b>60.6</b>	<b>99.7</b>	<b>94.6</b>
Hydrocarbons <sup>4</sup>	1.8	3.2	2.0	5.0
Waxes <sup>4</sup>	8.4	3.6	9.7	13.5
Triglycerides <sup>4</sup>	18.7	38.2	39.9	45.7
Higher alcohols <sup>4</sup>	9.6	6.1	7.7	10.6
Diglycerides <sup>4</sup>	5.3	1.4	8.5	2.6
Monoglycerides <sup>4</sup>	5.3	0.8	11.1	5.2
Oxidized cmpds <sup>4</sup>	13.1	1.9	14.5	6.7

<sup>1</sup>Ethyl Ether

<sup>2</sup>Weight percent of dry wood.

<sup>3</sup>Petroleum Ether

<sup>4</sup>Weight percent of PE soluble fraction

**Table 3.8: Producers of Tall Oil derived chemicals in the United States. [3.7(20)]**

Producer	Location	Capacity (short ton/y)
Arizona Chemical	Panama City, Fla.	80k
Arizona Chemical	Port St. Joe, Fla.	110k
Arizona Chemical,	Savannah, Ga.	120k
Georgia-Pacific,	Crossett, Ark	130k
Hercules,	Burlington Ontario (acquired by Eastman)	
Eastman Chemical,	Franklin, Va.	100k
MeadWestvaco,	Charleston Heights, S.C.	115k
MeadWestvaco,	De Ridder, La.	215k
TOTAL		870k

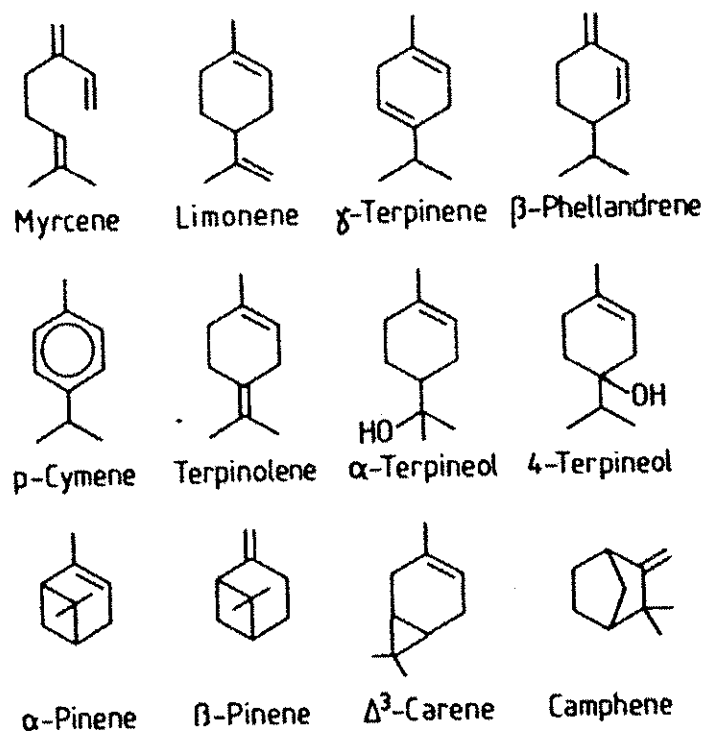
### 3.7.1 Terpenes

There are more than 4000 different terpenes based on isoprene (2-methyl butadiene) as the structural unit and are classified by the number of linked units, which are linked head to tail up to 5 units (Figure 3.9) [REF].

Name	Number of 5C-units	Structure
isoprene (basic unit)	1 × 5C	
Monoterpenes	2 × 5C	
Sesquiterpenes	3 × 5C	
Diterpenes	4 × 5C	
Triterpenes	6 × 5C	

**Figure 3.10: Basic classes of terpenes**

The monoterpenes contain acyclic, monocyclic and bicyclic compounds as shown in **Figure 3.11**. The rosins contain diterpenes (**Figure 3.12**) and diterpenoidic acids (**Figure 3.13**), and the neutral rosin acids. The tricyclic compounds are the backbone structure of sterols.



**Figure 3.11:** Monoterpenes common to softwoods

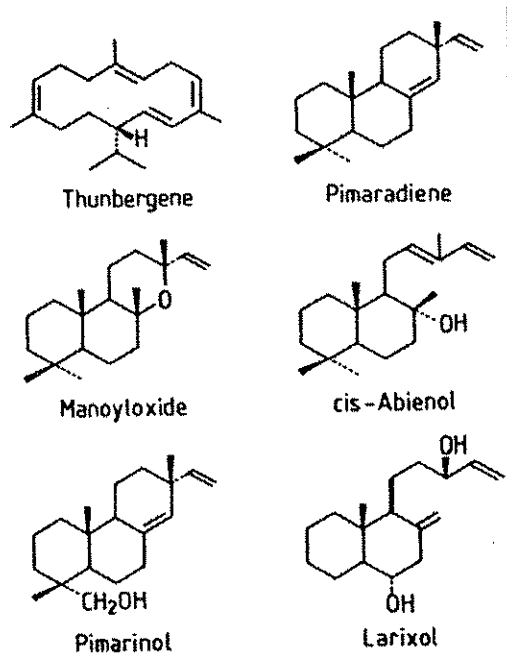


Figure 3.12: Neutral diterpenes from softwoods

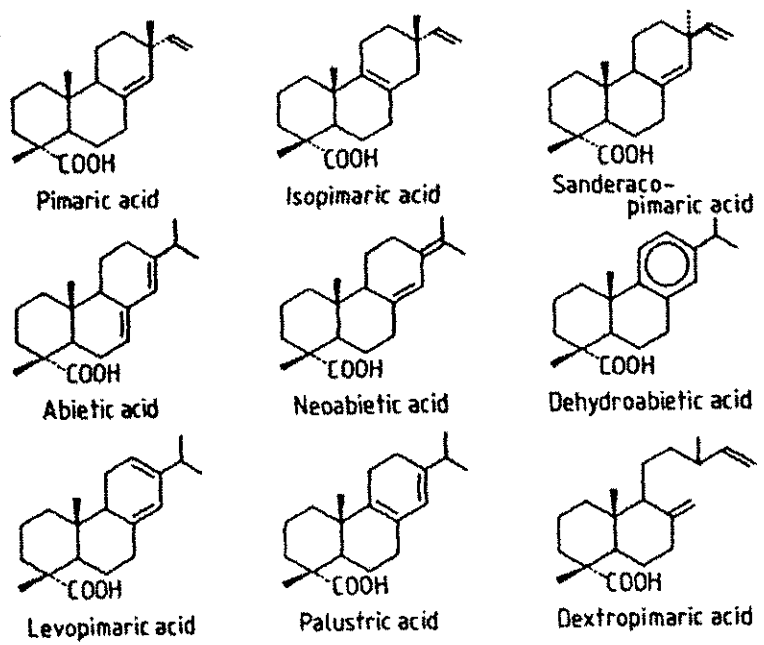


Figure 3.13: Acidic diterpenes (rosin acids) from softwoods

3.7.2: Fatty Acids



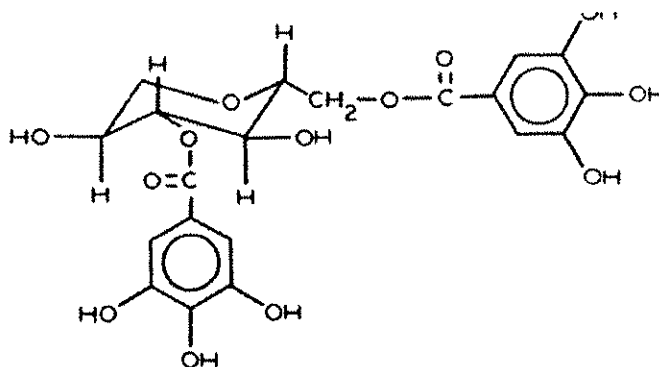
Glycerol can form esters with from one to three fatty acids, which are called mono-, di- and triglycerides, respectively, with the latter predominating. The major fatty acids are oleic, linoleic, and linolenic acids.

### 3.7.3 Tannins

Besides the terpene derivatives, the other important class of extractives for hardwoods is the tannins. Tannins are phenolics classified by their function in leather tanning rather than by chemical structure. They are classified as hydrolysable and condensed. The hydrolysable tannins are esters of gallic acid with simple sugars. A tannin content above 8% is needed for commercial potential if quality parameters can be met, but no commercial tannins are produced from oak. Tannins are extracted with aqueous sodium sulfite, which results in some sulfonation, giving increased solubility and imparts alkaline degradation of the polymeric flavanoids in oak to phenolic acids. The hardwood extractives will be discussed from a family perspective.

The best-known extractive from the Aceraceae family (maples) is maple syrup, which consists mainly of sucrose and an arabinogalactan. Other constituents include quebrachitol (2-O-methylinositol) (sweet crystalline compound) and phytokinins.

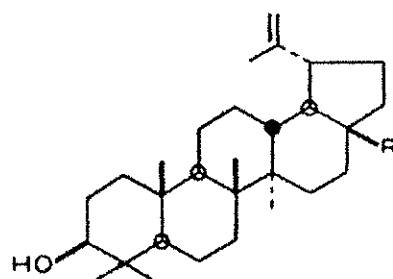
Tannins are only present in minor amounts in the barks of maples (i.e. red maple ~7%). **Figure 3.14** shows the structure of a typical maple-derived tannin. Two gallic acid units are esterified to a sugar unit and hence could be easily liberated by hydrolysis. The bark of red maple has been used in folk medicine [1.2(11)].



Acertannin (3,6-di-O-galloyl-1,5-anhydrosorbitol)

**Figure 3.14:** Typical tannin from mountain maple (*Acer spicatum*) bark [1.2(11)]

Birch bark was the historical source of methyl salicylate before synthetic routes were developed and teas were used by American Indians for medicinal purposes. Small amounts of tannins (~4%) are present in the bark. A white powder can be removed from the surface of the white bark that contains the pentacyclic triterpenes that is shown in **Figure 3.15**. Paper birch bark contains 1.5% betulin [1.2(11)].



Betulin (R=CH<sub>2</sub>OH)  
 Lupeol (R=CH<sub>3</sub>)

Figure 3.15: Triterpenes from birch bark

Oak is not a current commercial source of tannin in the United States. White oak bark has been employed historically for medicinal purposes because of the antiseptic nature on the tannins. Oak bark contains various condensed tannins based on catechin-gallic acid polymers (Figure 3.16). The sapwood of American beech may contain up to 4% extractives and the bark contains only 2.4% tannins [REF].

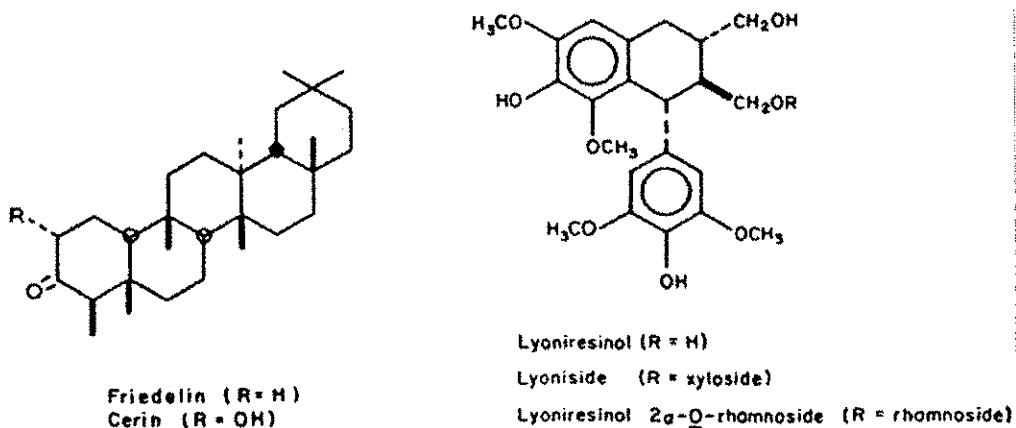
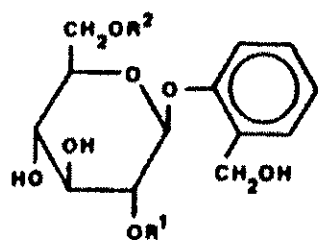


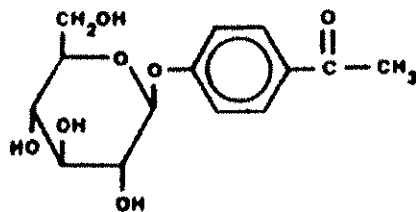
Figure 3.16: Oak triterpenes and lignans

The family Salicaceae includes the geni, *populus* and *salix*. The *Salix* contains approximately 100 species of willow in North America [REF]. The genus *Populus* includes the poplars and aspens [REF]. The predominant extractives in the *Salix* genus are the phenolic glycosides; examples are shown in Figure 3.17.



Salicin  $R^1 = H, R^2 = H$

Tremuloidin  $R^1 = C_6H_5CO-, R^2 = H$



Picein

**Figure 3.17:** Phenolic glycosides from *Salicaceae*

The bark of salix contains approximately 5% tannins and hydrolyzates contain p-hydroxybenzoic acid as well as syringic, vanillic and ferulic acids as well as other methoxy phenols such as vanillin [REF].

## 4.0 Market Penetration

The original intent of this task was to perform quantitative estimation of market penetration for the most promising specific products. While this remains an exercise of interest, it became more compelling to use the limited resources for this task to define potential deployment scenarios that the project sponsors could put into action. Therefore, the market penetration exercise was limited to developing a deployment model to establish the timeframe and implications on the feedstock base for the three core technology elements of pyrolysis, gasification, and fractionation.

### 4.1. Subjective Estimation of Market Penetration

In order to understand the timeframe and resource requirements for a bioenergy program of a transformational nature to the Maine economy, a set of assumptions were made about market penetration rate and market size, which are best thought of as goals. **Figure 4.1** shows the scenario where three waves of deployment occur based on pyrolysis, gasification and fractionation technology. In this first conceptual analysis, energy replacement is the only market considered with heating oil and combined heat and power as the products. This approach does not require too many assumptions about future product value and international competitive forces, as might be the case for a higher value product, such as phenol. These assumptions enable the basic premises of this approach to be evaluated.



Figure 4.1: Market penetration curves for the base deployment model

The market penetration curves are typical of Fisher Pry logistics ("S" shaped) [4.1(4)] with a linear annual growth rate of 2.5% after reaching maturity. It assumes that the three core technologies begin with a three year offset time and all reach market maturity in about 8 years. The point is not whether these are realistic assumptions to begin with, but rather that this is what needs to happen in order for the impact of 50% energy replacement to be realized in 20 years.

An induction period of five years is observed based on the establishment of pyrolysis conversion systems leading to 5% market penetration. The next five-year period has the superimposition of all three technologies at different maturity levels giving an overall linear increase in market penetration to 25%. The period from 10 to 15 years sees the onset of market maturity in fractionation resulting in a change of the total slope, which continues through the period from 15 to 20 years when all three processes are mature and experience 2.5% annual increases. It is not intended to imply that these three technologies will remain unaffected by new technology or that one will not displace the others in the long range.

The implications of these assumptions are shown in **Table 4.1**. A unit plant size of 715 dry tons/day is assumed based on the feedstock calculations discussed in the summary section. This plant size is independent of technology. This implies that 74 plants will be required over 20 years. Assuming capital costs comparable to biopower (\$2.5M/MWe), the cost of a plant is approximately \$33 million and the total capital investment would be \$2.75 billion over 20 years. The first plant must be running in three years and in just five years, seven plants are to be in operation to meet this deployment schedule.

**Table 4.1: Implications of base model assumptions**

Year	Trillion BTU	% of Maine Energy	Tons/Day @ 50% Eff.	% of USDA Growing Stock	Plants 715 t/d
3	2	1	636	0.1	1
5	17	4	4,664	0.4	7
10	92	24	25,453	2.0	36
15	149	39	41,234	3.3	58
20	191	50	52,783	4.2	74

A breakdown of Maine energy consumption by sector and source is shown in **Table 4.2**. Maine used 384 trillion BTU (0.4 quads) with 30% coming from petroleum [REF]. Half of the petroleum is for distillate, which is primarily heating oil. Note that the second largest use for energy is wood due to the industrial sector and the third largest use is due to losses in electricity production. These markets will grow, therefore no effort was made at this point to specify the exact market shares of these sources and sectors that will comprise the 50% energy market share.

**Table 4.2: Maine energy use by sector and source [4.2.1.1(90)]**

	2001 Maine Energy Use, Trillion Btu				% by Source
	Residential	Commercial	Industrial	Total	
Wood	3	3	100	106	28
Distillate	40	15	5	59	15
Total Petrol.	54	18	44	116	30
Electricity	16	15	9	40	11
Elect losses	36	35	20	91	24
Total	111	74	199	384	100
2 % by Sector	29	19	52	100	

#### 4.2 Potential Market Scenarios

This section describes the economic and policy drivers that could affect the rate of market penetration. We consider three drivers in defining the possible scenarios: technology, economics and policy. Since each can have either high or low impact, there are six possible combinations, or scenarios, that must be considered, as shown in **Figure 4.2**.

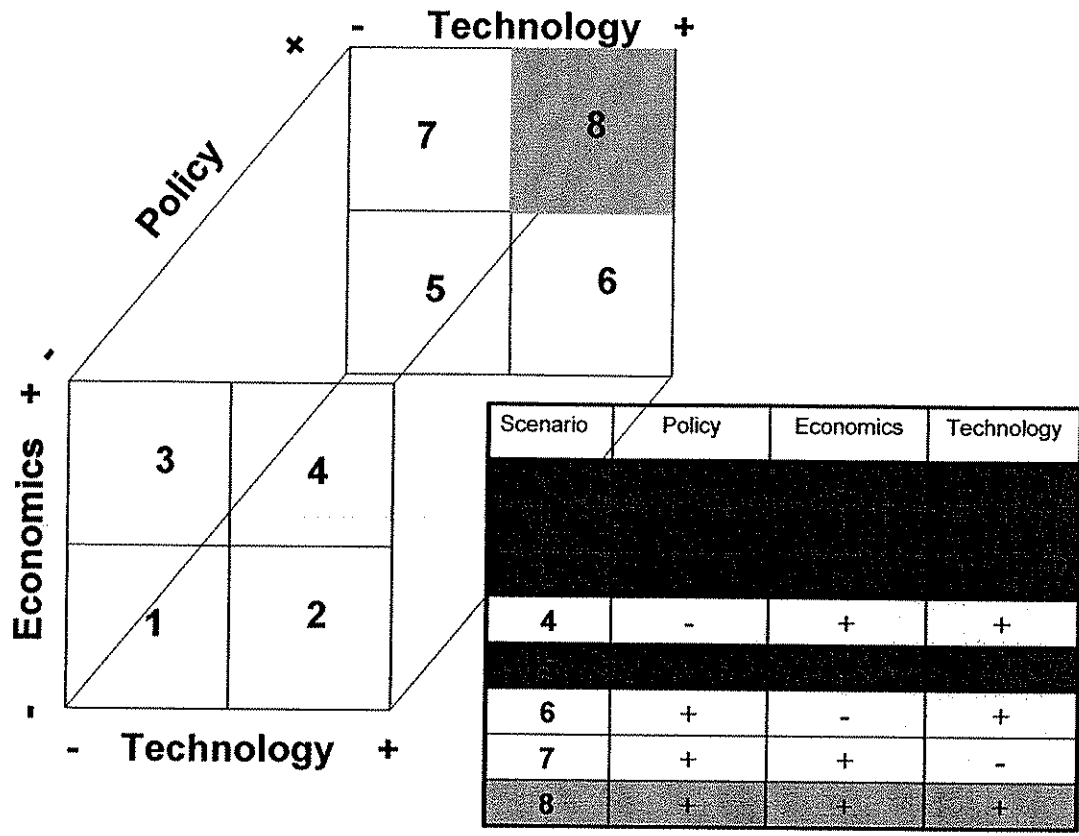
In scenario 1, the social economic and technology drivers are all negative. By this, we mean that

- No policy, such as carbon tax or RPS are in place
- The cost of conventional energy is relatively low
- No compelling technology is pushing its way into the market.

Under these conditions, no significant market penetration will be observed as was the case for biopower after the PURPA (Public Utilities Regulatory Policies Act) [REF] policy was ended.

The three scenarios, 2, 3, and 5, where two of the drivers are low are also considered non-starters. For the three scenarios where one driver is negative, 4, 6, and 7, the time base for 50% market penetration will be significantly longer.

**Scenario 8** is the only case with significant potential to make a significant economic impact in Maine. In the following sections, each driver is discussed from the perspective of Maine, North America and International market developments.



**Figure 4.2:** Graphical representation of the interaction of the three market drivers: Policy, Economics and Technology, in defining 8 scenarios and their classification as non-starters (red), questionable (yellow) and conducive (green)

#### 4.2.1 Technology

Technology was emphasized in this report because of its importance in establishing cornerstone technologies that will grow into new markets over time and allow an alternative to typical commodity market dynamics. The impact of feedstock must be considered in every driver. The Maine forest feedstock is a well-established market commodity and is significant and competitive from a North American perspective. However, it is not unique or dominant as the comparison in Section 1 shows. The mix of hardwoods and softwoods means that fractionation technology will be more difficult (i.e., take more time to develop) so thermochemical processes have been proposed as the near-term step in establishing the technology cornerstone. For the production of heating oil substitutes, pyrolysis is proposed as the simplest, most independent route since gasification to more conventional products will require the participation of large corporations and their acceptance of the product in the complicated energy and chemical infrastructure that exists in the Northeast.



However, the deployment of pyrolysis, worldwide, has been slow and public investment is needed at a scale comparable to the Burlington gasification process. It is not too late for Maine to establish a leadership position in this field and build on the years of experience accumulated from several key research activities, primarily in Canada, which features fluid bed technology. Pyrolysis ideas suggested in this report are deviations from the conventional path of fast pyrolysis: moderate temperature pyrolysis resulting in higher char yields, and hybrid gasification/pyrolysis systems. Such propositions are really beyond the scope of this study, and not at all tied to the conclusions reached.

#### *4.2.2 Economics*

At this writing the price of natural gas and petroleum products are at an historical high. In the early eighties the price of oil reached, the current level (in constant dollars) but demand fell and the price eventually hit record lows [REF]. No one can say what the demand response to the current high costs will be, but the situation is different now. China and other developing economies are growing at twice the rate of western economies and show no sign of cutting back on the investment in modernization. The likely scenario is that the age of cheap oil is over and the ceiling will most probably stay well above \$40/barrel. The U. S. has the highest natural gas prices in the world and there is no reason that will drop substantially even if liquefied natural gas is imported. **In short, and unfortunately, the economic drivers are most likely to remain positive through the induction period while new biorefinery capabilities are brought on line.**

The biggest economic challenge is analogous to the history of the pulp and paper industry. Maine has faced challenges in pulp and paper from the Southern states where growth rates are higher and costs are lower. For energy and chemicals production, other locations are closer to the prime petroleum processing centers and major population areas, which is a factor for competitiveness. For example, the Midwest states have a head start in bioprocessing to produce new functional chemicals due to the corn ethanol industry as well as the proximity to the extensive industrial complex in that area [REF]. For this reason, the emphasis was put on the heating oil market that can be locally integrated and become the cornerstone market for secondary market penetration.

The real long-term threat is from international competition. Some developing countries are ideally located for biomass production, such as Brazil, and can produce products for commodity markets cheaper than in North America, just as they can with paper [REF]. For these reasons, vertical market integration has been emphasized in the evolution of the recommended approach.

#### *4.2.3 Policy*

***DRAFT FOR REVIEW***

**The Chewonki Foundation  
Hydrogen Market Study**

**November 2005**

Prepared for:  
The Chewonki Foundation  
Wiscasset, Maine

Prepared by:  
Acadia Environmental Technology  
4 Milk Street  
Portland, ME 04101

Acadia Project Number 192-001

## EXECUTIVE SUMMARY

Acadia Environmental Technology (Acadia) was retained by The Chewonki Foundation to prepare a Market Study of Hydrogen for Northern New England. The study was funded by the River Valley Growth Council (RVGC) of Rumford, Maine. The purpose was to compile a current "snapshot" view of the hydrogen market in Maine, New Hampshire and Vermont, examining production, distribution, use, and trends.

To conduct the work, Acadia conducted face-to-face and telephone discussions with market participants, conducted internet research, spoke with State Energy Offices and federal agencies, and contributed to a public workshop at the Chewonki Foundation held on November 9, 2005. Discussions, research findings, and workshop contributions were compiled in preparation of this market report.

Hydrogen is the lightest element, and has the highest energy content per unit weight of any known fuel. However, because of its molecular weight, it is very light, with a pound occupying approximately 192 cubic feet at standard temperature and pressure. Due to this density, for effective industrial, commercial or fuel use, hydrogen must be efficiently stored. Current storage options are as a high pressure gas (at 5 to 10,000 psi), as a liquid (below -253 degrees Celsius, its boiling point), or bound as a metal hydride at atmospheric conditions.

Global production of hydrogen is approximately 50 million metric tons per year, whereas US production is approximately one-fifth of this amount, at about 9 million metric tons per year. Most of this hydrogen (62%) is produced on-site for immediate industrial needs, such as in refining, and is referred to as "captive" hydrogen. The balance (38%) is termed "merchant" hydrogen and, after production, is transported by third parties for sale to others. Although there are multiple commercial means of producing hydrogen, the vast majority (95%) of hydrogen produced in the US is made by reformulation of natural gas.

Hydrogen use in northern New England is limited to a few significant industrial users and a number of smaller users. The industrial users include the semiconductor industry and the glass filament manufacturing industry. The users of smaller volumes include the power industry, electronics, laboratories, welding, and R&D.

Methods of hydrogen transport and sale are directly related to usage rates. The largest users, with consumption rates of over 20,000 standard cubic feet per hour (scf/h), produce captive hydrogen on site. However, no users at this size exist in northern New England. Users with a demand of 500 to 20,000 scf/h tend to have liquid hydrogen delivered in specialized low temperature trucks, where liquid hydrogen storage is provided at the facility site, and the hydrogen required in the industrial process is evaporated and used as required. Several facilities of this size are present in northern New England, including National Semiconductor, Fairchild Semiconductor, and Elmet Industries. Below a hydrogen use rate of 500 scf/h, economical hydrogen delivery may be by tube truck or by individual gas cylinders. Users at this level include the power generation industry,

laboratories, and R&D facilities. At smaller volumes, hydrogen may be generated on site. This is about to occur at the Chewonki Renewable Hydrogen Project in Wiscasset, Maine, where the production rate will be 1.9 scf/h (15 standard L/hr) once the facility is operational in late 2005.

Taking into consideration those users below 500 scf/h, distribution of hydrogen in northern New England tends to be through distribution companies, namely, MaineOxy, AirGas, and Advantage Gases & Tools. Of these three companies, only MaineOxy, after a request for this study, disclosed to Acadia its throughput of hydrogen, at 400,000 to 500,000 scf per month. The other distribution companies chose to keep their market information private. Northern New England clients of distribution companies include: power generation industry; pulp and paper; electronics; welding; laboratories; R&D.

Trends in hydrogen use are not well known or readily predicted. Industrial gas companies serve existing clients and they adjust production to meet changes in the industrial demand. In general, growth in hydrogen use in northern New England will be based on increased uses such as: semiconductors; R&D; home heating; distributed power supply and backup power systems; personal vehicles; public vehicles; and portable equipment such as computers and cell phones.

## SECTION 1. INTRODUCTION

The energy economy of the United States is largely dependent on imported petroleum. Current petroleum imports exceed 55 percent of national demand, and are projected by the United States Department of Energy (USDOE) to approach 70 percent by 2025. Partly in response to the negative aspects of imported fuel dependency, the US Government has expanded its R&D commitments to diverse domestic energy supplies, including hydrogen. The Hydrogen Fuel Initiative represents a portion of the government's expanded R&D. The recently-enacted Energy Policy Act of 2005 also includes subsections and specific initiatives related to hydrogen.

Hydrogen-related activities in Maine have drawn upon federal funding for R&D on hydrogen. The River Valley Growth Council (RVGC) in Rumford, Maine obtained federal funding in early 2005 to support its efforts into developing alternative energy projects, focusing on the potential for producing renewable fuels from cellulosic feedstocks which are abundant in the region. Accordingly, in January 2005 the River Valley Growth Council (RVGC) approved a contract with the Chewonki Foundation of Wiscasset for conducting a study intended to develop a better understanding of the existing and potential hydrogen market in Maine, New Hampshire and Vermont (northern New England). The purpose is to understand the potential for a Maine-based hydrogen production facility to sell into the nearby existing and potential hydrogen market. This work represents one component of a range of alternative energy projects being pursued by RVGC.

This market report, prepared on behalf of The Chewonki Foundation, presents a 'snapshot' understanding of the current hydrogen market in Maine, New Hampshire and Vermont, along with discussion of potential hydrogen usage trends. The outcome of the work is intended to assist the RVGC in planning for future renewable energy projects, including projects that could utilize forest biomass as feedstock for producing alternative fuels and specialty gases.

The report has been prepared by Acadia, with input from The Chewonki Foundation, the Maine Center for Enterprise Development (MCED), and many volunteer members of the Hydrogen Energy Center (HEC), a Maine-based advocacy group. Valuable insights and comments have been obtained from interviews with the hydrogen distribution and use community in Maine, New Hampshire and Vermont. Contact has also been made with state and federal energy agencies to obtain views on trends in hydrogen use. A workshop was held in early November 2005, attracting nearly 60 stakeholders, from which additional valuable insight was obtained regarding potential future demand for hydrogen in the region. Attendees at this workshop are listed in Appendix A.

Preparing a market report on hydrogen in northern New England is challenging for several reasons. First, because hydrogen use is currently commercial and industrial, and the product itself is not regulated as a fuel in the marketplace, its production and use are

not documented by state or federal government agencies, and no taxes are levied that create records of use. As a result, information is held in private hands, and the companies may or may not choose to disclose it. Secondly, the projection of use is hypothetical, since future use will depend on rates of technology development and commercialization/implementation, which are speculative.

A significant portion of the material which has been reviewed and incorporated into this report has been drawn from personal contacts, from available websites and from published references. A list of website resources is provided as Appendix B.

## SECTION 2. BACKGROUND

### **What is Hydrogen?**

Hydrogen is the simplest, lightest, and most common element in the universe. It does not occur by itself in nature on the earth, but is found in association with other compounds. Since it does not occur by itself, it is produced from a wide range of feedstocks. It is colorless, odorless and tasteless, and has the highest energy content per unit of weight of any known fuel; on a weight basis, for example, it has nearly three times the energy of gasoline. Its uses worldwide are currently industrial and commercial. Hydrogen has been in mass production and transportation for over fifty years in the United States.

### **Global and US Production**

Current global production of hydrogen is approximately 50 million metric tons per year. US production is currently approximately 9 million metric tons per year. Most hydrogen is presently produced very close to or at the point of use, to minimize storage and transportation needs. So-called "merchant" hydrogen, which is defined as a sale of hydrogen that occurs between two separate companies, is approximately 38% of the total North American hydrogen production capacity. Alternatively, "captive" hydrogen, that which is produced on-site for on-site use, is approximately 62% of the total capacity. Captive hydrogen production in the United States occurs primarily at petroleum refineries.

### **Methods of Production**

All hydrogen production processes are based on the separation of hydrogen from hydrogen-containing feedstocks. The feedstock itself defines the available types of separation method, which can be thermal, electrochemical, or biological. Globally, nearly 50% of hydrogen production is from natural gas reformulation. An additional 48% is made from oil and coal. In the United States, the majority (95%) of hydrogen production is presently by natural gas reformulation.

Production methods currently in widescale use are briefly outlined below.

- In steam reformulation, natural gas is combined with high temperature steam. This process is well understood and less expensive than other hydrogen formulation methods.
- In biomass gasification, biomass is heated in a reactor, producing various gases including methane. The methane is then reformulated through the steam reformation for hydrogen production.
- Coal gasification is a third means of hydrogen production. In this process, coal is converted into a gaseous state, and then treated with steam and oxygen, which results in the formation of hydrogen gas, carbon monoxide and carbon dioxide.
- Electrolysis involves passing an electric current through water, thereby splitting the molecules into hydrogen and oxygen. Large amounts of electricity are required for electrolysis.

Additional production methods are being explored, including pyrolysis, photoelectrochemical, photobiological, anaerobic digestion, and fermentation.

### **Environmental and Life Cycle Issues regarding Hydrogen Production**

Hydrogen is currently considered an alternative energy source. At the present stage of its evolution into a role in the alternative energy mix, experts tend to choose the term “energy carrier” to describe how hydrogen can provide energy for transportation, heating, and electrical generation. This term is used because hydrogen is produced by applying energy to chemicals or compounds that contain hydrogen, enabling the hydrogen to be removed and stored as H<sub>2</sub>. This form is then a chemical ready to provide energy output.

The current discussion of hydrogen distinguishes its attribute as a “carrier” from other fossil fuels that are considered “sources”. In geologic terms, fossil fuels have already had the energy inputs provided over a longer time frame. Therefore, the distinguishing of hydrogen as a “carrier” or a “source” may be misleading to the general public, and may be a barrier to broad public acceptance of hydrogen as a viable replacement to the petroleum fuels that the world depends on today.

A frequently-cited environmental concern with regard to hydrogen production methods is the amount of carbon dioxide that is released as a result of hydrogen production. Although hydrogen is commonly promoted as a clean and virtually limitless fuel, its true degree of ‘cleanliness’ is also a function of how it is produced. For example, should it be produced from electrolysis, the electricity used for hydrogen production would need to be obtained from a renewable source, such as geothermal, hydropower, solar or wind, in order for the carbon dioxide impacts associated with carbon-based electrical generation to be reduced or eliminated.

Although carbon sequestration methods are currently stated (by USDOE and by certain researchers) as a means of reducing or eliminating the net carbon dioxide impacts of hydrogen production from electricity, these remain hypothetical, and have not been proven as practical on a large scale. As another example of carbon impacts, production of hydrogen from natural gas reformulation also produces carbon dioxide, and unless this carbon dioxide is sequestered in some way, it is released to the environment.

### **Hydrogen Storage Methods**

This market report does not focus on hydrogen storage, but for completeness and to assist in understanding how the northern New England hydrogen market functions, the topic is discussed briefly. Although hydrogen contains more energy per unit weight than any other energy carrier, because of its lightness it contains much less energy per unit volume. The molecular weight of hydrogen is 2.02, and its specific volume is 192 cubic feet per pound at standard temperature and pressure. Storage of sufficient hydrogen in a small space requires advanced technologies. Current-day examples of storage include:

- High-pressure storage tanks, in which hydrogen is stored as a gas at pressures of up to 5,000 to 10,000 psi;
- Liquid hydrogen, in which hydrogen is stored at a very cold temperature;



- Solid metal hydride storage, in which hydrogen is combined chemically with a metal, which can be more efficient than a high-pressure storage tank, as it does not require pressurized storage. The hydride acts much like a sponge, providing a large surface area, with which the hydrogen loosely bonds. The hydrogen is released by heating the metal hydride, the equivalent of squeezing the sponge. Researchers around the world are seeking better hydrides which can store more hydrogen and require less heat for hydrogen release.

### **Hydrogen Uses**

Virtually all current uses of hydrogen are commercial and industrial. The largest consumer of hydrogen is the fertilizer industry, which uses it to create ammonia. The compound is also used as a chemical to produce reformulated gasoline, food products (primarily hydrogenated oils), and petrochemicals. It is also used in the power generating industry for cooling, and in the electronics industry for creating precision manufacturing environments. It is utilized in welding and in studies of cryogenics. A minor user of hydrogen in the United States is NASA where it is used as a fuel for rocket propulsion and, through the use of fuel cells, to provide power and drinking water on the space shuttle.

Potential future uses of hydrogen are wide ranging, since the molecule has the ability to serve as a clean source of energy for the US economy. The possible uses include, but are not limited to, private and public transportation, power generation, industrial heating, and portable power supplies. As noted above, hydrogen must be produced from other sources, as it does not occur naturally on earth, and that production itself requires energy, therefore the terminology of a "limitless" source is not correct. Even if unlimited energy sources (renewables) are used, a feedstock is required, and none are truly limitless.

Demonstration projects are under way in various parts of the United States for new uses of hydrogen. These include vehicles and buses in California, vehicles in New York, and stationary fuel cell systems across the country, including an electrolyzer/fuel cell system at the Chewonki Foundation in Wiscasset, Maine.

### **Grades of Hydrogen**

Hydrogen is classified in several grades. The grade required by hydrogen users depends on the use of the gas. These purity grades have various names depending on the industrial gas in question. The names commonly used for hydrogen grades are provided below in Table 2-1. The overall percentage purity is listed in the right-hand column.

**Table 2-1  
Grades of Hydrogen**

<b>Grade</b>	<b>Name</b>	<b>Minimum Purity</b>
Hydrogen 6.0	Scientific	99.9999%
Hydrogen 5.0	Ultra High Purity (UHP)	99.999%
Hydrogen 4.5	Zero	99.995%
Hydrogen 4.0	Prepurified	99.99%
Hydrogen 4.0	High Pressure	99.99%

Where possible in this report, the grade of hydrogen is referred to in the market discussion. According to Praxair, the hydrogen required for fuel cells should be Hydrogen 4.5, that is, 99.995% pure. In some cases, the nature of the impurities present in the industrial gas is as important as the purity level.

### SECTION 3. MARKET STUDY APPROACH

This report provides a snapshot of the hydrogen market in northern New England (ME, NH and VT). Information has been gathered in the following manner.

- Discussions were held with members of the Hydrogen Energy Center, an advocacy group for hydrogen in Maine;
- Internet research was conducted, including review of information on hydrogen at the USDOE site, the National Hydrogen Association, the American Hydrogen Association, the Rocky Mountain Institute, and many other sources;
- Discussions were held with: MaineOxy, the largest distributor of hydrogen in Maine; Airgas, a distributor serving the region; and with Advantage Gases, a distributor serving Maine;
- Contact was attempted with the major producers of hydrogen in the United States, however, all of those producers were non-responsive to repeated calls and emails;
- Contact was made with the two largest users of hydrogen in Maine, namely, the two semiconductor manufacturing companies (National Semiconductor and Fairchild Semiconductor), as well as with Elmet Technologies;
- Discussions were held with representatives of the state offices of energy in ME, NH and VT;
- Discussions were held with technology providers and participants on the Chewonki Foundation Hydrogen Demonstration Project; and,
- A public workshop on the hydrogen market was held at the Chewonki Foundation on November 9, 2005. The attendees at this workshop, approximately 60, are listed in Appendix A.

The focus of the work is on opportunities where hydrogen potentially produced in northern New England could be utilized in northern New England.

## SECTION 4. NORTHERN NEW ENGLAND MARKET OVERVIEW

For the purposes of this report, the northern New England region comprises Maine, New Hampshire and Vermont. This market is characterized by out-of-region production, a few very large users, and a number of small users of hydrogen. The discussion in this section first addresses the means of hydrogen delivery that existing hydrogen users can choose from. Then it presents available information on delivery and use.

### Hydrogen Delivery Methods

On a nationwide level, current industrial users of hydrogen typically select between five different means of obtaining hydrogen depending on their usage rates. Table 4-1 lists these options and provides ranges of applicability.

**Table 4-1**  
**Hydrogen Supply/Delivery Options for Industrial Users**

Means of Obtaining Hydrogen	Range of Usage Scf/hr	Significant Requirements
1. On site large-volume generation	Over 20,000	Typically at refineries and food processing facilities
2. Liquid hydrogen delivery	500 to 20,000	Delivery in a specialized liquid hydrogen truck or in rail cars
3. Tube truck delivery	20 to 500	Delivery in a hydrogen tube truck
4. Cylinder delivery	Up to 20	Delivery of full cylinders
5. On-site small-volume electrolysis	Up to 250	On-site electrolysis

This report focuses on the latter four entries (2 through 5) in Table 4-1 and does not address the on site large-volume generation, as it is not applicable in northern New England.

### Hydrogen Production for Northern New England

Producers of hydrogen for the northern New England market include:

- The BOC Group, with the closest distribution center in Acton, MA
- Air Products, with the closest distribution center in Marlboro, MA
- PraxAir, with the closest distribution center in Suffield, CT

Other hydrogen producers in the US are Linde and Air Liquide. Hydrogen production in the US is highly concentrated geographically. For example, according to the Massachusetts Hydrogen Coalition, some 40% of the US liquid hydrogen production was temporarily placed off-line due to two major hurricanes in the southern US in fall 2005.

The major gas production companies are involved in the hydrogen economy and efforts to advance hydrogen use in the United States. For example, BOC was sponsor of the 2005 National Hydrogen Association (NHA) annual conference in Washington DC. BOC states in its corporate literature that it is strongly committed to the development of hydrogen as an energy source, through support of hydrogen energy projects around the world. Air Products recently established advanced hydrogen fueling stations in San Jose, California for a fleet of hydrogen-fueled buses.

There are other potential producers of hydrogen in northern New England. At a small scale, the Chewonki Renewable Hydrogen Project will produce hydrogen for on-site use at its teaching facility. Other potential producers are identified in Section 5 of this report.

**Shippers and Distributors**

As hydrogen is not currently produced in northern New England for off-site shipment, the hydrogen usage discussed in this report is based on out of state production.

The largest hydrogen users in the study region are serviced by direct, high-volume hydrogen deliveries in liquid form. Smaller users in Maine, NH and VT are serviced by distributors with local depots in all three states. Three major distributors in the region are listed in Table 4-2.

**Table 4-2  
Hydrogen Distribution Companies in Northern New England**

<b>Company Name</b>	<b>Geographic Markets Served</b>
MaineOxy	Maine, New Hampshire, Massachusetts
AirGas	Throughout New England
Advantage Gases & Tools	Maine, New Hampshire

Consultation with MaineOxy indicates that the hydrogen users they service are in Maine, New Hampshire and Massachusetts. Clients include power plants, laboratories and manufacturers. Consultation with AirGas confirms that their clients in this region are in New Hampshire, Vermont and Massachusetts. Their clients include power plants, laboratories, manufacturing, and fuel cell technology companies. Advantage Gases also provides hydrogen to clients in Maine and New Hampshire.

**Hydrogen Users in Northern New England**

None of the hydrogen distribution companies in the region were willing to share or disclose their client lists to Acadia. However, all of them were willing to describe categories of users. Accordingly, Table 4-3 lists categories of users and the purpose of hydrogen use for each.

**Table 4-3**  
**Categories of Hydrogen Users in Northern New England**

<b>User Name</b>	<b>Purpose</b>
National Semiconductor	Fabrication of semiconductors
Fairchild Semiconductor	Fabrication of semiconductors
Elmet Technologies	Manufacturing of lighting elements
Power generation industry	Recharging and lubrication of turbines
Universities	Research
Electronics	Heat treating applications in manufacturing
Fuel Cell R&D	Research and Development for fuel cell applications
Laboratories	Gases for equipment calibration

**Quantities of Hydrogen Used in Northern New England**

The research for this market study demonstrates that use rate data were difficult or impossible to obtain. Acadia obtained only a few numbers despite repeated contacts by both telephone and email. The two local semiconductor industries disclosed their hydrogen usage rates. MaineOxy disclosed its monthly hydrogen throughput. Beyond this no data are readily available.

Combined, the two semiconductor manufacturers use some 400 million standard cubic feet of hydrogen per year.

MaineOxy states that its hydrogen sales, both wholesale and retail, amount to some 500,000 standard cubic feet per month, or 6 million standard cubic feet per year. Therefore, the entire throughput of a major distributor is only 1.5% of the amount of hydrogen used by the semiconductor manufacturing industry in the region.

## **SECTION 5. PROJECTED HYDROGEN MARKET TRENDS IN NORTHERN NEW ENGLAND**

This section presents a discussion of market trends in hydrogen use in northern New England. The discussion addresses generation and use. The forecasting of hydrogen use is speculative. Hydrogen must be forecast both in its potential value as an energy “carrier”, or fuel, for transportation, heating, and electrical generation; and in its value as a chemical for industrial, manufacturing, and chemical applications.

The topics and discussion below are based on various sources, including, but not limited to, discussions with: current users and distributors; state and federal energy agencies; manufacturers of hydrogen generation and fuel cell equipment; and proponents of alternative fuel projects. Much valuable input was obtained from a public workshop on November 9, 2005 at the Chewonki Foundation. Additional insights were provided by representatives of the Hydrogen Energy Center and the Massachusetts Hydrogen Coalition. The time frame and scale of each trend are then summarized in a table at the end of this section. It is emphasized that this discussion has a regional focus, reflecting and examining opportunities in Maine, New Hampshire and Vermont.

### **Semiconductor Manufacturing**

Semiconductor manufacturing companies, Fairchild Semiconductor and National Semiconductor, anticipate continuing to use hydrogen in their precision manufacturing processes. This hydrogen is a high grade (ultra high purity) and will, for the near term, continue to be provided from outside the region and delivered in liquid form in large quantities. The grade required for semiconductor manufacturing is higher than for all other uses addressed in this report, and precludes local production from serving the semiconductor manufacturing industry. However, when examined from the opposite angle, it is possible that the industry itself could serve some of the potential hydrogen market in northern New England. This is because the industry discharges hydrogen from its manufacturing processes; as well, hydrogen in small quantities is vented from their on-site liquid hydrogen storage systems. The hydrogen released could potentially provide a source for hydrogen for use in fuel cells or for IC engines. This topic deserves further discussion.

### **Chewonki Renewable Hydrogen Project**

A highlight in the region is the Chewonki Renewable Hydrogen Project, at the Chewonki Foundation in Wiscasset, Maine. This project provides a hands-on demonstration of the viability of hydrogen energy systems and the economic and educational opportunities they can provide. The system includes an Avalence Hydrofiller 15 high-pressure electrolyzer and three, one kilowatt Relion Independence 1000 fuel cells. The project will result in hydrogen generation and utilization at the site of a well-established environmental education center. This undertaking reflects the efforts of numerous individuals and organizations, including but not limited to the Chewonki Foundation, the Hydrogen Energy Center (HEC), the Maine Energy Investment Corporation, several consulting companies, and many volunteers.

### **Bio-refinery Producing Hydrogen**

The River Valley Growth Council and other cooperating groups in western Maine have promoted the concept of a bio-refinery that would utilize cellulosic biomass for production of a variety of energy sources and chemical products, including hydrogen. One of the goals is to make better use of the cellulosic resources (wood and wood residue) available in the region. This project has been under discussion for over a year, and it is currently envisioned that it could sustainably produce up to 28 million scf (70 tons) per day of hydrogen at a production cost of \$1 per pound or less. The grade of hydrogen that would be produced is not yet known as it would depend on both processing and storage mechanisms. Should this project proceed, it would have a significant impact on hydrogen availability in the region.

### **Wallace Avenue Sustainable Hydrogen (WASH) Project**

The HEC is also involved in other initiatives in Maine. The HEC is leasing land in South Portland from MaineOxy, and is currently researching the feasibility of local production of hydrogen at that site. The goal is to produce renewable hydrogen for the northern New England market. HEC is presently preparing a business plan for the project. Should this project proceed, it would provide an opportunity to demonstrate, at a reasonably large scale, the ability to produce hydrogen using renewable energy. The potential scale of this project has not yet been fully defined by HEC.

### **MaineOxy Proposed Hydrogen Distribution Project**

MaineOxy, a distributor of industrial gases in northern New England, distributes hydrogen for retail sales purposes from six locations. The company has been investigating the purchase of an electrolyzer from Avalence. This electrolyzer would produce up to 125,000 scf per month of hydrogen as well as by-product oxygen. The company would be able to sell both gases to its existing customers. The production and sale of oxygen would assist in boosting the economics of this project. As of November 2005, the company continues to negotiate with suppliers of electricity and with the electrolyzer supplier. MaineOxy hopes that if its distribution project is implemented, it will provide an opportunity for hydrogen-powered vehicles to be fueled in the region.

### **Marine Vessels**

A Maine-based company, Marine Propulsion Systems Incorporated, is investing in research and development for an environmentally friendly marine propulsion system. The company's current strategy is to develop a system that would use biofuel in a fuel reformer to produce hydrogen on-board commercial or private boats. The company reported on its latest work at a public workshop on November 9, 2005. Although the timing of this initiative is not certain, it represents an opportunity for vessel owners and operators to utilize renewable fuels for production of hydrogen for on-board use.

### **Home Heating Applications**

Northern New England homes rely heavily on oil and wood for home heating. According to US Census information from 2000, of all the households in Maine, 80% rely on oil for



heating; 8% rely on propane gas or natural gas. Assuming that, for discussion purposes, 5% of these households could potentially convert to hydrogen as a primary heating source, this would represent 0.4% of all homes in Maine. Based on the average oil consumption of 850 gallons per year per household, and converting to the equivalent energy content in hydrogen, the annual hydrogen demand from this number of households could approach 90 million scf per year. This represents 15 times the current throughput of hydrogen of one dealer in Maine, MaineOxy. However, it is noted, of course, that there is currently no initiative in place to stimulate such a conversion.

#### **Public and Personal Vehicles**

Research is under way to design personal vehicles operating on hydrogen using internal combustion engines (ICE) and fuel cells. Research is also progressing and some products are available promoting hydrogen as a supplemental fuel, a secondary fuel, or a fuel that will increase gasoline economy. No such vehicles exist in northern New England at present. No retail hydrogen fueling capacity is available in northern New England. Across the country, a very limited number of hydrogen-powered vehicles are operating. A "hydrogen highway" has been implemented in California. A new fueling station providing hydrogen has been built in Washington, DC and another is under construction in White Plains, New York.

#### **Portable Equipment**

Equipment is being introduced into the marketplace which is powered by hydrogen, either in pressurized gas form or in metal hydride form. For example, research and development is under way for introducing battery supplies for microelectronic equipment which would be powered by hydrogen. Such devices could replace traditional rechargeable battery packs, and could offer longer duration with lighter weight than currently available systems.

#### **Summary**

Various usage trends are identified in this section of the report. While the list is by no means exhaustive, it provides some idea of how demand for hydrogen in the region may evolve. Table 5-1 lists the trends identified above and provides an indication of timing and scale.

**Table 5-1  
Trends in Hydrogen Production and Demand in Northern New England**

<b>Trend</b>	<b>Category</b>	<b>Timing</b>	<b>Scale</b>
Semiconductor Manufacturing	Demand; potential production using spent and vented hydrogen	Immediate and projected to continue	Significant user of liquid hydrogen. May also provide hydrogen for the local market
Chewonki Renewable Hydrogen Project	Production for on-site use	Startup in late 2005	Minor scale but significant in terms of local and regional awareness
Bio-refinery in western Maine	Production for regional sales	Startup not certain; proposals under discussion	Up to 70 tons per day of renewable hydrogen
WASH Project	Production for local and regional use	Under review	Moderate scale, up to 125,000 cubic feet per month or more
MaineOxy Hydrogen Production and Distribution Project	Production for local and regional markets	In planning, projected for early 2006	Moderate scale, up to 125,000 cubic feet per month
Marine Vessel Propulsion	Production for on-board use in boats	In R&D phase in Maine	Scale not known
Home Heating Applications	Demand throughout the region	Long term	Could be significant but nonexistent at present
Public and Personal Vehicles	Demand throughout the region	Long term	No vehicles present as of this writing
Portable Equipment	Demand nationwide	In R&D phase outside the region	Not known

**APPENDIX A. PARTICIPANTS AT NOVEMBER 9, 2005 HYDROGEN  
WORKSHOP**

**APPENDIX B. NEWSPAPER ARTICLES FOLLOWING NOVEMBER 9, 2005  
HYDROGEN WORKSHOP**



- HOME

---

- MAINEJOBS
- HOMES
- WHEELS
- MARKETPLACE

---

- NEWS
  - Local and State
  - Midday/4PM Reports
  - AP Wire
  - InDepth
  - Week in Photos
- WEATHER
  - 5-day Forecast
  - On the Ocean
- SPORTS
  - High Schools
  - Red Sox
  - Pirates
  - Running
- BUSINESS
  - News
  - Blogs
  - Maine News Direct
  - Classifieds
- ENTERTAINMENT
  - Calendar
  - Movies
  - Dining
  - Music
  - Theater
  - Art
- TRAVEL
  - Maine Regions
  - From Away
  - Vacation Rentals
  - Lodging Guide
- OUTDOORS
  - Hunting
  - Hiking
  - Field Notes
  - With Children
  - Campground Guide
- BLOGS
  - Weather Blog
  - Editor's Blog
  - Food for Thought
  - More blogs
- 20 BELOW
  - Teen Blogs
  - This Just In
  - Bulletin Board
- MAINEJOBS
  - Search Jobs
  - Post a Job
  - News and Resources
  - Employer Profiles
- HOMES

## BUSINESS *Maine's complete business resource*

Home | Blogs | News | Features | Calendar | Resources | Classifieds

Thursday, November 10, 2005

[E-mail this story to a friend](#)

### Hydrogen energy technology on display

By TUX TURKEL, Portland Press Herald Writer

Copyright © 2005 Blethen Maine Newspapers Inc.

WISCASSET — Facilities that could produce hydrogen for industrial gases and for fueling buses and delivery vehicles are being considered for Auburn and South Portland. These facilities could get all or part of the power they need to make hydrogen from renewable resources, such as solar electric panels.

These facilities would be Maine's only commercial hydrogen production plants, and represent the state's first commercial efforts to turn the plentiful gas into a transportation fuel.

News of the plan emerged Wednesday at a workshop organized to highlight the status of hydrogen development in New England. It was hosted by the Chewonki Foundation, which is building a \$240,000 demonstration project that

Also on this page: [FOR MORE](#)

**BRAIN**

- Office
- Bookke
- Event
- Plannin
- Web &
- Graphic
- Design

**South**

Lots Available  
[www.kevi.com](http://www.kevi.com)

**FirstPo**

EXCITING O  
FOR YOUR E

ADVERTISEMENT

Worried about the cost of healthcare?  
The Maine Health Forum can help.

**The Maine Health Forum**  
Sponsored by  
Franklin Community Health Network  
& Franklin Memorial Hospital

Sharing healthcare news, information, and opinions for all of Maine.  
[www.mainehealthforum.org](http://www.mainehealthforum.org)

Classifieds  
 Advice and Info  
 Featured Agents  
 Moving to Maine  
 Retiring in Maine

**WHEELS**

Classifieds  
 Resources and Info  
 Featured Dealers

**MILESTONES**

Celebrations  
 Obituaries

**MARKETPLACE**

Classifieds  
 Special Sections

**ADVERTISING**

5 Reasons  
 Advertising Products

**MEMBER CENTER**

Press Herald  
 Sunday Telegram  
 Kennebec Journal  
 Morning Sentinel  
 MaineToday.com



Network Affiliate

will use renewable energy to generate hydrogen and to power fuel cells for electricity production. The project is expected to be operational by spring.

**FOR MORE**

TO LEARN more about hydrogen energy go online at [www.chewonkih2.org](http://www.chewonkih2.org).

Supporters see hydrogen as a [To top of story](#) way for the United States to make a transition away from oil, coal and natural gas, and to shake its dependence on imported energy.

As petroleum prices rise, governments and industry are spending millions of dollars to develop hydrogen technology, which can be used to run vehicles and produce heat and electricity. Hydrogen produced with help from wind, solar and hydro sources, for instance, creates energy that is pollution-free and doesn't contribute to global warming.

But hydrogen takes energy to produce, and methods of creating, storing and marketing it as a substitute for conventional power applications are still evolving. Several states, notably California, are investing heavily in the technology and creating "hydrogen corridors," where a string of filling stations can refuel hydrogen-powered vehicles.

The Auburn facility would cost up to \$500,000 and could be ready as early as next year. It would be developed by Maine Oxy, a supplier of welding products and industrial gases. The Auburn-based company has eight locations in Maine, Massachusetts and New Hampshire.

Maine Oxy is preparing to buy an electrolyzer, a device that uses electricity to convert water into hydrogen and oxygen. Maine Oxy sells both these gases, which are used in various forms by industry. That will help the economics of the project, according to Bruce Albiston, the company's chief executive officer.

Most of the electricity to make hydrogen is likely to come from the utility grid. But Albiston may add solar panels to meet up to 20 percent of the load. He's also considering filling stations on company property in Rockland, Brewer, Waterville and South Portland.

Potential customers include delivery fleets, he said, such as United Parcel Service. Fleets are starting to experiment with hydrogen vehicles, Albiston said, but the practice isn't likely to grow until more fueling stations are developed.

"It's kind of a chicken and egg thing," he said.

The South Portland facility is still in the concept stage. It's being promoted by the Hydrogen Energy Center, a Portland-based advocacy group. The facility would be located in an industrial park on Wallace Avenue, on land owned by Maine Oxy. It would be

called the Wallace Avenue Sustainable Hydrogen Project.

Gary Higginbottom, a spokesman for the center, said his group has had initial talks with Portland's Metro bus system about fueling at the site. Metro's bus system is being converted to natural gas, and that fuel can be mixed with hydrogen. A bus system in Fort Collins, Colo., is doing this now, he said.

The long-term goal in South Portland is to produce hydrogen with electricity from on-site renewable energy sources, such as solar panels. To save money, Higginbottom said, power might initially come from renewable power purchased over the utility grid, such as hydroelectric generation.

The Hydrogen Energy Center is developing a business plan and funding proposal. It hopes to decide by summer whether the project is financially viable and what technology to use.

One example of hydrogen technology is close to completion at Chewonki's Center for Environmental Education.

In the woods behind the building, a specially constructed shed holds eight hydrogen gas cylinders and a seven-foot-high cabinet containing an electrolyzer. The \$40,000 unit, built by Avalence LLC of Milford, Conn., will produce enough hydrogen to store four days worth of backup power for the building. Inside, a battery bank and three fuel cells, which generate electricity by combining hydrogen and oxygen from the air, are part of the circuit.

Workshop participants viewing the installation asked Marty Shimko, Avalence's executive vice president, why the technology has taken so long to develop.

"Too many dinosaurs died for too many years and provided us with cheap fuel," he replied.

*Staff Writer Tux Turkel can be contacted at 791-6462 or at:*

[tturkel@pressherald.com](mailto:tturkel@pressherald.com)

[To top of page](#)



Questions/Comments?  
Copyright © 2005, Blethen Maine Newspapers, Inc.

The Times Record  
**timesrecord.com**  
 Maine's Mid-coast Starts Here  
 11/15/2005

ADVERTISEMENT  
 **Parkview** *We're Here!*  
 ADVENTIST MEDICAL CENTER 329 Maine St., Brunswick 078-2000

HOME NEWS SPORTS OPINION OBITUARIES WEATHER



FEATURES SELECTED ARTICLES FROM OUR WEEKLY FEATURE SECTIONS  
 WORD FEATURED ARTICLES FROM MID-COAST TEEN WRITERS

# News



## Getting the 'H' out of H2O

*Bob\_Kalish@TimesRecord.Com*

11/15/2005



### Chewonki Foundation hosts conference looking at potential of hydrogen as an alternative fuel.

WISCASSET — What's next for Peter Arnold?



Chewonki Foundation's intrepid explorer of alternative energy — his official title is director of alternative energies pathways — Arnold has made a name for himself by pioneering the use of biodiesel to run the furnace and vehicles at Chewonki.

#### ABOUT US

- [About Us](#)
- [Advertise](#)
- [Submit an Announcement](#)
- [Employment](#)
- [Letters to the Editor](#)
- [Photo Reprints](#)
- [Subscribe Online](#)

Now he has turned his sights on hydrogen, by developing a hydrogen-based fuel source that can provide backup electricity for the Environmental Education Center.

The Chewonki renewable hydrogen project, as it is called, was one of the main attractions at the state's first-ever conference on the economic aspects of hydrogen energy held Wednesday at Chewonki.

Best sites

The half-day event featured speakers on various aspects of hydrogen production, distribution and usage. It drew a robust audience of about 80, and was sponsored by the River Valley Growth Council, Environmental and Energy Technology Council of Maine and the Hydrogen Energy Center.

Hydrogen is the current sweetheart of the alternative energy world, and has even been endorsed by oilman President George W. Bush.

But how do you get a concept off the ground and into the main arena? How do you make a reality out of a dream?



Well, you start small. Arnold began making biodiesel using 5-gallon plastic buckets of fryer oil. Now he has 50-gallon tanks and makes regular rounds picking up used fryer oil from area restaurants.

The hydrogen project required construction of a special outbuilding behind the educational center.

The process begins with water and ends with electricity to provide four days' worth of backup power for the center's water pump and furnace. The problem with hydrogen is it takes up a lot of room. So to use it efficiently, hydrogen must be stored under pressure. What makes Chewonki's system unusual is that it can make and store hydrogen under pressure without needing a compressor.

"Hydrogen can be made easily," Arnold said. "The thing is, it does no good to make hydrogen using electricity that is made by using fossil fuels. What we want to do is get away from fossil fuels to a form of energy that is renewable. Therefore, if electricity can be made by biofuel or solar or some other renewable fuel, then you're not adding more to the problem of fossil fuels."

At Chewonki, that electricity is made partially from solar panels on the education center's roof. Also, the foundation is part of a network that uses "green sources" for the electricity it receives from Central Maine Power Co. So the electricity used to make Chewonki's hydrogen is produced either by solar, biomass or hydro.

Here is how it works: An electric current is run through water by means of an instrument called an electrolyzer, which separates the hydrogen from the oxygen. The hydrogen is stored under pressure in eight T-tanks, the kind of tanks that hold oxygen and other gasses.

There are two ways to use hydrogen to produce energy. It can be used as a fuel to burn directly in internal combustion engines, in the same manner natural gas is used, or hydrogen can be used to make electricity by combining it with oxygen, basically reversing the process used to make hydrogen.

To use hydrogen for electricity, the stored hydrogen is mixed with atmospheric oxygen to make electricity by means of a fuel cell.

Such technology can be used for hybrid automobiles. Drivers would fill up with hydrogen at filling stations, like they do today with gasoline.

At Chewonki the hydrogen is stored in its tanks until a need arises for the gas to be turned back into electricity.

Other facets of the inaugural hydrogen conference dealt with the business aspects: How to market and encourage more projects such as Chewonki's.

Brad Bradshaw, a representative from Massachusetts Hydrogen Coalition — a state organization dedicated to finding sources and encouraging uses of hydrogen in that state — spoke of a future using hydrogen fuel cells in the computer industry.

"A laptop with a fuel cell that will last for 24 hours," he said. "Would there be a market for that?"

Scott Christiansen, of the Fractionation Development Center in western Maine, is studying making hydrogen from biomass (mainly waste from forest industries). It's possible to make 70 tons of hydrogen a day from the waste created by the wood industry, Christiansen said.

As the price of fossil fuels increases, alternate energies look more cost efficient.

According to Bruce Albiston, of Maine Oxy, his company is working on creating hydrogen at its Auburn facility rather than driving to Massachusetts to truck it back to Maine.

"We see an opportunity to develop a hydrogen business, an addition to our business of supplying industrial gasses," he told the conference. "If it costs us \$3 a gallon to truck it back and forth from Massachusetts, well, it would be more efficient to make it ourselves."

Albiston said his company was "working out some glitches" in making hydrogen but he anticipates working them out.

"By 2006, we'll be pushing our own hydrogen," Albiston said.

Then there are organizations such as the Maine Hydrogen Energy Center, which acts as a statewide clearinghouse for hydrogen research. The interest and activity in Maine has pleased Arnold.

"I'm impressed there's so much hydrogen activity in Maine," he said following the conference. "The purpose of this conference was to document that activity, and we did that. One of these days we're going to run out of oil, that's a given. So we're on the right track by encouraging research into alternate fuels."

[Top of Story](#)

**REQUEST FOR PROPOSALS:**

**FOREST BIOPRODUCTS  
MATCHING FUND PROGRAM**

**MAINE TECHNOLOGY INSTITUTE**  
*Investing in Promising Technologies*

2E Mechanic Street, Gardiner, Maine, 04345  
Phone: 207-582-4790 Fax: 207-582-4772  
[www.mainetechnology.org](http://www.mainetechnology.org)

**APPLICATION DEADLINE: JUNE 7, 2004**

**Purpose:** The Maine Technology Institute (MTI) was created by the State Legislature in 1999 to encourage, promote, stimulate and support research and development activity leading to the commercialization of new products and services in the State's technology-intensive industrial sectors to enhance the competitive position of those sectors and increase the likelihood that one or more of the sectors will support clusters of industrial activity and to create new jobs for Maine people (5 MRSA c. 407).

The 2004 congressional budget appropriated nearly \$1,000,000 from the Department of Energy (DOE) for "Maine Forest Bioproducts Research and Development." This initiative supports development and testing pulp and paper mill waste processing, pulpwood processing and bioproduct applications to recover valuable platform chemicals.

This appropriation provides approximately \$380,000 for MTI to administer in competitive awards to stimulate forest bioproducts research and development projects leading to commercialization of new products or services.

**Goals and Objectives:** The DOE funds are established as a source of matching funds for the MTI Development Award program specifically to stimulate forest bioproducts research and development at Maine-based companies and not for profit research institutions. The Forest Bioproducts Matching Funds (FBMF) will be awarded for projects that qualify for funding under the MTI Development Award program, for early stage Research and Development activities that are leading to the commercialization of new products or services related to forest bioproducts.

**Award Amount:** FBMF will be awarded as match funding for approved Development Awards, contingent on the availability of funds. The match requested from FBMF may not exceed 75% of the total match required for the project, and cannot exceed 1.5 times the amount of MTI funds requested. FBMF do not require repayment, but do require strict adherence to federal DOE reporting and compliance guidelines. FBMF funds will be disbursed concomitant with the MTI funds, according to the milestone schedule agreed to by the Recipient and MTI.

**Types of Projects Supported & Eligibility:** In order to be considered for the FBMF, projects must be approved for an MTI Development Award, according to the requirements of that program. Approved Development Award projects that include research and development related to forest bioproducts are eligible to be considered for the FBMF. The DOE for fit and compliance to federal guidelines and laws also must approve projects approved through the MTI Development Award process.

Forest bioproducts research and development focuses on processes and enabling technologies that will establish forest biomass as a significant source of sustainable fuels, heat, power, chemicals and materials. Projects that collaborate with Maine's other efforts to develop a Maine-based forest products biorefinery, such as efforts underway at the University of Maine or the River Valley Growth Council, are strongly encouraged.

Products developed from forest bioproducts include food, fiber, heat, power and carbon-based fuels and chemicals. It is expected that competitive proposals will address needs and topics identified by the DOE in its Biomass Program and focus on forest bioproducts. Further information regarding biomass technologies is found in the DOE multi-year technical plan (MYTP) at: [http://devafdc.nrel.gov/biogeneral/Program\\_Review/](http://devafdc.nrel.gov/biogeneral/Program_Review/).

**Application Process:** Requests for matching funds from the FBMF must follow the directions for the Development Award program. The project description and budget detail must clearly indicate the amount and use of FBMF match requested.

Applicants are encouraged to call MTI to discuss the unique application requirements of this program.

**Review Process:** Eligible projects will be reviewed on a competitive basis according to the procedures for the MTI Development Award program. It is expected that competitive proposals will be for comprehensive research and development projects that will help advance new innovation related to forest bioproducts toward the commercial market.

Projects for products that will ultimately reach the market in more than three years qualify for Far to Market Development Awards of up to \$250,000 each. Projects for products or services that will reach the market within three years qualify for Near to Market Development Awards for up to \$500,000 each.

Application and detailed instructions for the Development Awards are found at: <http://www.mainetechnology.org/proposal-dev.asp>. Instructions in the RFP must be closely followed and all required forms submitted. Briefly, complete proposals are reviewed for scientific and technical merit by outside, expert peer reviewers for potential benefit to the State of Maine by an MTI technology board, and for the capacity to carry out the project by a business review committee comprised of members of MTI's technology boards and Board of Directors. DOE staff for merit and compliance with federal regulations will further review projects that propose to utilize FBMF.

**Award Decisions:** Final award decisions are made by the MTI Board of Directors, according to the MTI Development Award process, and require approval by the DOE to ensure compliance with all federal regulations and guidelines.

**Reporting Requirements:** Projects approved for funding must agree to the MTI Development Award Agreement. Recipients of FBMF also will be required to agree and comply with an MTI sub-recipient agreement acknowledging their agreement to DOE requirements, including all reports and certifications. Recipients must report activities and provide expense verification on a milestone basis, not less than quarterly, in a format acceptable to MTI and DOE. A final report must be provided at the project's end, and all documentation maintained by the Recipient for five year's following project completion.