

*Project Director
Melissa Malkin-Weber*

*Project Manager
Cyrus Dastur*

*Research Associates
Maria Mauceri
Benjamin Hannas*

Final Technical Report

Closed Crawl Space Performance:
Proof of Concept in the Production Builder Marketplace
October 1, 2004 – March 31, 2007

Instrument # DE-FC26-04NT42319

January 11, 2008

Submitted to:
Parrish Galusky
Project Manager
U.S. Department of Energy,
National Energy Technology Laboratory

Technical Contact:
Cyrus Dastur
Project Manager
Advanced Energy
Phone: 919-857-9000
Facsimile: 919-832-2696
cdastur@advancedenergy.org



Advanced Energy

*909 Capability Drive
Suite 2100
Raleigh, NC 27606-3870
www.advancedenergy.org*

DISCLAIMER

This report was prepared as an account of work sponsored by an agency of the United States Government. Neither the United States Government nor any agency thereof, nor any of their employees, makes any warranty, express or implied, or assumes any legal liability or responsibility for the accuracy, completeness, or usefulness of any information, apparatus, product, or process disclosed, or represents that its use would not infringe privately owned rights. Reference herein to any specific commercial product, process, or service by trade name, trademark, manufacturer, or otherwise does not necessarily constitute or imply its endorsement, recommendation, or favoring by the United States Government or any agency thereof. The views and opinions of authors expressed herein do not necessarily state or reflect those of the United States Government or any agency thereof.

ACKNOWLEDGEMENT STATEMENT

This report was prepared with the support of the U.S. Department of Energy, under Award No. DE-FC26-04NT42319. However, any opinions, findings, conclusions, or recommendations expressed herein are those of the author(s) and do not necessarily reflect the views of the DOE.

SUBMITTED TO:

Parrish Galusky, Project Manager
U.S. Department of Energy, National Energy Technology Laboratory
3610 Collins Ferry Road, P.O. Box 880 [MS-E06]
Morgantown, WV 26507-0880
Phone: 304/285-4358, Parrish.Galusky@netl.doe.gov

SUBMITTED BY:

Advanced Energy
909 Capability Drive, Suite 2100, Raleigh, NC 27606
Phone: 919/857-9000, Fax: 919/832-2696, Website: www.advancedenergy.org

Project Director:
Mrs. Melissa Malkin-Weber, Phone: 919/857-9000, mweber@advancedenergy.org

Project Manager:
Mr. Cyrus Dastur, Phone: 919/857-9005, cdastur@advancedenergy.org

Introduction

This overview is intended to be a very concise, limited summary of the key project activities discussed in the detailed report that follows. Due to the large scope of this project, the detailed report is broken into three individually titled sections. Each section repeats key background information, with the goal that the sections will eventually stand alone as complete reports on the major activities of the project. The information presented herein comes from ongoing research, so please note that all observations, findings and recommendations presented are preliminary and subject to change in the future. We invite and welcome your comments and suggestions for improving the project.

Origins

Advanced Energy completed its first jointly-funded crawl space research project with the Department of Energy in 2005. That project, funded under award number DE-FC26-00NT40995 and titled “A Field Study Comparison of the Energy and Moisture Performance Characteristics of Ventilated Versus Sealed Crawl Spaces in the South” demonstrated the substantial energy efficiency and moisture management benefits that result from using properly closed crawl space foundations for residential construction instead of traditional wall vented crawl space foundations.

Two activities of this first project included (1) an assessment of ten existing homes to document commonly observed energy and moisture failures associated with wall-vented crawl space foundations and (2) a detailed literature review that documented both the history of closed crawl space research and the historical lack of scientific justification for building code requirements for crawl space ventilation.

The most valuable activity of the 2005 project proved to be the field demonstration of various closed crawl space techniques, which were implemented in a set of twelve small (1040 square feet), simply designed homes in eastern North Carolina. These homes had matched envelope, mechanical and architectural designs, and comparable performance characteristics with regard to infiltration and duct leakage. Researchers settled on two closed crawl space designs, one with insulation located in the framed floor structure above the crawl space and one with insulation on the crawl space perimeter wall, as the designs with the most widespread potential for application. Researchers based this assessment not only on the field performance, but also on input from residential builders, pest control professionals, code officials, installers, and building scientists active in the region.

The key findings from the field demonstration were that (1) closed crawl spaces stay substantially drier than traditional wall-vented crawl spaces during humid climate conditions, and (2) the houses built on the closed crawl space foundations saved, on average, 15% or more on annual energy used for space heating and cooling. A comparison of the actual energy performance of the homes versus the performance predicted by a popular HERS software application showed that the software was unable to predict the demonstrated savings, in some cases predicting an energy penalty.

Findings from the 2005 project were summarized in a publication titled “Closed Crawl Spaces: An Introduction to Design, Construction and Performance.” Since its release, the publication has received widespread use by builders, homeowners, installers and code officials concerned about crawl space construction. The findings were also used to create major revisions to the NC Residential Code, which were adopted in 2004 and immediately began to reduce the regulatory barriers to widespread commercialization of the technology in NC, particularly in new residential construction. Full project details are located at www.crawlspace.org.

Research Plans

The striking improvements in both energy and moisture performance that resulted from use of closed crawl spaces in the 2005 North Carolina project inspired a set of research questions that form the basis for this new multi-year, multi-state project:

- (1) Can closed crawl spaces provide similar improvement in energy use and/or moisture control in climate areas outside of eastern North Carolina’s mixed humid climate?
- (2) Can closed crawl spaces be implemented, and their associated benefits realized, in the production home builder marketplace?
- (3) Can a business supply chain be established, in a given market or on a national level, which will, for its own financial self interest, grow the use of closed crawl spaces in the marketplace?
- (4) Can any popular energy modeling software applications successfully predict the energy performance of closed crawl spaces?

These questions will be investigated via three focused sets of activities:

- (1) Recruitment of three production builders, in geographically distinct regions of the United States, to establish research sites. These builders must be willing to construct at least twelve houses, of similar design and performance characteristics, that will be monitored for moisture and energy performance over a twelve-month post-construction period. This activity is reported in the Housing Characteristics Report.
- (2) Assessment of the existing supply chains and markets for closed crawl spaces. Recruitment for a Marketplace Committee of private industry partners who are willing to invest time, materials and/or funds, to provide the expertise, materials and services needed to help design or establish the research sites. These partners will also inform researchers of their intent to participate in the commercialization of closed crawl spaces based on their experiences with installation and evaluation of the performance benefits vs. implementation costs of closed crawl spaces. This activity is reported in the Business Supply Chain Commercialization Report.

- (3) Assessment of the ability of several popular residential energy use modeling software to allow input of closed crawl space foundation designs and accurately predict the energy impact of the closed crawl space foundation design, as compared to measured performance data from the three research sites. This activity is reported in the Computer Modeling Report.

In Budget Periods 1 and 2, these are the target objectives for each activity:

- (1) Recruitment and Housing Characteristics Assessment
 - a. Identify and recruit three builder partners to provide research sites
 - b. Identify and recruit private industry partners to contribute goods and services
 - c. Develop design specifications and installation protocols for each site
 - d. Finalize data logging requirements
 - e. Schedule construction
 - f. Complete construction of homes
 - g. Install monitoring equipment
 - h. Begin data collection
- (2) Business Supply Chain and Commercialization Assessment
 - a. Begin documenting the closed crawl space supply chain
 - b. Begin documenting incentives and barriers to commercialization
 - c. Begin preliminary assessment of potential markets
 - d. Document material and supply chain requirements of each market
- (3) Computer Modeling Assessment
 - a. Identify and procure nine software tools
 - b. Use Princeville, NC (2005 Study) data to eliminate ineffective tools

Project Status

At the end of Budget Period 1, the Department of Energy was unable to fully fund Budget Period 2 activities. The DOE provided partial funding to Advanced Energy to support project activities during the six-months from October 2006 through March, 2007 during which funding was transferred to the National Center for Energy Management and Building Technologies, another DOE funding recipient with available funds.

- (1) Recruitment and Housing Characteristics Assessment
 - a. Three builder partners signed written agreements to provide research sites for the project. They are:
 - Empire Communities in Flagstaff, AZ
Empire will provide the following research homes, all with mechanical systems (gas furnaces with optional air conditioning) in the crawl space:
 - 4 houses with traditional wall-vented crawl spaces

- 4 houses with closed crawl spaces with R-19 floor insulation
- 4 houses with closed crawl spaces with R-13 wall insulation
- Habitat for Humanity of Greater Baton Rouge, LA
Habitat for Humanity will provide the following research homes, all with package unit heat pumps outside and duct trunk lines in the crawl space. Audubon General Contractors will provide site development and foundation construction. Palm Harbor Homes will provide foundation design and modular homes. This site will have an expanded configuration of homes:
 - 3 houses with traditional wall-vented crawl spaces and supply ducts routed in the attic
 - 4 houses with closed crawl spaces with floor insulation and supply ducts routed in the attic
 - 4 houses with closed crawl spaces with wall insulation and supply ducts routed in the attic
 - 4 houses with closed crawl spaces with floor insulation and supply ducts routed in the crawl space
- 36 Builders in Greenwood, DE
36 Builders initially committed to provide the following research homes, all with mechanical systems (gas furnaces with air conditioning) in the crawl space and all with the same floor plan:
 - 4 houses with traditional wall-vented crawl spaces
 - 4 houses with closed crawl spaces with floor insulation
 - 4 houses with closed crawl spaces with wall insulation
 Final specifications were still under development for the Greenwood site at the end of BP 1.

During the transition of BP 2 project funding to NCEMBT, 36 Builders changed their construction designs such that they would have to build 12 new homes to provide a comparable research site. The associated delay in construction, coupled with a lack of funding from NCEMBT to support three research sites, resulted in Advanced Energy removing the Greenwood, DE site from the project in early 2007.

This overview and the associated technical reports will report on activities completed with 36 Builders prior to their separation from the project.

- b. The following corporations are currently represented on the Marketplace Committee, in addition to the builder partners above:
- American Aldes
 - Dow Chemical Corporation

- E3 Energy
 - Hilti Corporation
 - Hurlock Building Products
 - National Pest Management Association
 - Pest Management Systems Inc. (PMI)
 - Raven Industries
 - SmartVent
 - Sostram Corporation
 - Therma-Stor
 - Trotter Company
- c. Design specifications and protocols have been developed for the Flagstaff site. Design specifications and protocols have been developed for the Baton Rouge site. Design specification were begun for the Greenwood site.
 - d. All data loggers and meters have been specified. Logger and meter installations have begun in Flagstaff and Baton Rouge.
 - e. Palm Harbor sited all fifteen homes in Baton Rouge in the fall of 2007, and AE technicians installed monitoring systems as the houses were completed. By March 2007 all homeowners had moved into the home and were beginning enrollment in the project. Empire Communities had completed seven of the project homes and had three in construction at the end of March 2007.

(2) Business Supply Chain and Commercialization Assessment

- a. North Carolina, due to its rapidly growing closed crawl space industry, is a good place to learn from an existing market. Researchers developed questionnaires for phone interviews and on-site interviews of several NC closed crawl space installers. The intention of these interviews was to gather information about current material and tool choices, problems installers encounter with installations, how they resolve such problems, how they view the market for closed crawl spaces, and what factors would help them be more successful in the market.
- b. The North Carolina installer interviews also provided insights into market incentives and barriers, and conversations with recruited builders and the stakeholders in their respective markets provided region-specific input.
- c. Market data from private partners and the National Association of Home Builders Research Center provided guidance as to which markets have significant numbers of homes built on crawl space foundations, which thus provides indications of where energy savings may be most rapidly achieved.
- d. The commercialization assessment was dropped from the project during the transition to NCEMBT due to lack of funding for this activity.

(3) Computer Modeling Assessment

- a. The following software tools were procured for initial analysis:

<u>Application</u>	<u>Version</u>	<u>Developer</u>
AUDIT/ RHVAC	7.02.26/ 8.01.151	Elite Software
Energy-10	1.7	Sustainable Buildings Industry Council
EnergyGauge	2.42	Florida Solar Energy Center
EnergyPlus	1.3	United States Department of Energy
Micropas	6.01	Enercomp, Inc.
REM/Rate	12.11	Architectural Energy Corporation
Right-Suite Residential	6.0.27	Wrightsoft Corporation
TREAT	3.0.19	Performance Systems Development Inc.
VisualDOE	4.1.2	Architectural Energy Corporation.

- b. Based on testing against data from the 2005 study, three applications will be used for energy analysis during the remainder of the study— EnergyGauge, REM/Rate, and TREAT. These applications did not have any major flaws with the study design parameters and had the ability to distinguish between crawl space designs. As the study progresses, each application will be further scrutinized to see if they are able to estimate usage beyond North Carolina. The applications will also be tested for robustness in terms of architectural details found across the country.
- c. The computer modeling assessment will continue under the NCEMBT-funded project.

Potential Energy Benefits

In order to assess the potential energy benefits of closed crawl spaces, researchers used the energy savings documented at the Princeville, North Carolina site (2005 study) to extrapolate the potential savings for the entire country using the DOE Official Method for Determining National Benefits. This analysis was initially presented in the Project Proposal Narrative:

Preliminary research is indicating a 36% household cooling energy savings when using the wall insulation method. However, this method brings a 4% heating energy penalty. It is likely that this method is best for primary cooling climates where more than 70% of homes are air conditioned. This study will investigate whether or not this particular savings rate holds true in other geographic regions. If it does hold true, closing crawl spaces has a maximum potential annual savings of **99 trillion BTU**. This savings would also represent **1.6 million metric tons of carbon emissions savings**.

The second method of closing crawl spaces uses a floor insulation method. Preliminary research indicates a 22% reduction in cooling energy usage and a 10% reduction in heating energy usage. Again, this expanded research will show if these preliminary indicators will hold true in other climate zones. If this system was to be adopted nationally and the numbers hold true, there is the potential for an annual savings of **388 trillion BTU and 6.0 million metric tons of Carbon.**

Clearly, there is a large potential for energy savings and carbon emission reduction here. Even if we reach *only* the 200,000 new homes built annually using crawl space foundations we can reduce energy consumption by 14.9 million BTU per home, or 2.9 trillion BTU per year, compounded with future years' construction.

The national potential for savings will vary based on how much impact closed crawl space systems have in climates different from the mixed-humid climate zone of the Princeville, North Carolina site.

To try to establish some hypothesis for the variation in potential savings by climate, researchers analyzed a representative plan from the Flagstaff, AZ site (cold climate) and a representative plan from the Baton Rouge, LA site (hot-humid climate) in REMRate, varying the foundation design from vented to closed, to see what savings were predicted. Noting that REMRate was not able to accurately predict the savings documented in Princeville, the researchers calculated the difference between the predicted and actual savings in Princeville and applied that difference to the values predicted by REMRate for the home designs in Flagstaff and Baton Rouge. The results of that analysis indicate that closed crawl space foundations applied in Flagstaff have the potential to reduce heating energy use (therms) by 18% and to reduce cooling energy use (kWh) by 28%. In Baton Rouge, closed crawl spaces have the potential to reduce annual energy use (kWh) by 19%. These admittedly uncertain estimates indicate that the potential savings in cold and hot-humid climate zones may be even greater than those experienced in the mixed-humid climate zone.

Taking the accurately sub-metered energy savings attributed to the closed crawl space systems in the Princeville study, which were 15% or greater on an annual basis, and multiplying that by 40% as the average fraction of heating and cooling energy as compared to whole-house energy use, indicates that the closed crawl space system alone was responsible for a 6% reduction in total household energy use. This represents 10% of the 60% energy savings target for residential construction by 2010 presented by the Building Technologies Program. Furthermore, the Princeville savings rate may be conservative when compared to typical construction, since the control homes were of significantly higher construction quality than is documented in typical North Carolina residences.

Non-Energy Benefits

In addition to robust energy savings potential, closed crawl space foundations dramatically reduce moisture levels as compared to traditional wall-vented crawl space foundations in the southeast. This moisture management benefit results in:

- Reduced risk of mold growth
- Reduced risk of wood decay
- Reduced risk of termite or other wood-destroying insect infestation
- Reduced potential for moisture-related builder and contractor callbacks like:
 - Buckled hardwood floors
 - Musty odors
 - Uncomfortable humidity
 - Condensation on ductwork, piping, and insulation

Ongoing Advanced Energy research for the U.S. Department of Housing and Urban Development (HUD) is exploring the role of closed crawl space foundations in providing improved indoor air quality.

Conclusions

The housing characteristics study should remain the fundamental activity to be completed as it has been the axis around which all deliverables have been completed to date.

North Carolina has ever increasing numbers of builders implementing closed crawl spaces, with some indicating that they are able to install basic systems at no additional cost of construction. This development coupled with the moisture liability improvements of the system make closed crawl spaces not just cost effective but simply the more economical choice for knowledgeable builders. Expanding the research results to other regions can reasonably be expected to have similar results.

With regard to the computer modeling activity, it is critical that markets know whether the selected software applications provide accurate predictions to ensure that closed crawl spaces get their due respect for providing energy savings. Such savings predictions will encourage commercialization because they provide necessary documentation for tax credit programs and can be marketed to consumers.

Housing Characteristics Report

Closed Crawl Space Performance:
Proof of Concept in the Production Builder Marketplace

U.S. Department of Energy
Instrument No. DE-FC26-04NT42319

January 11, 2008

Project Directors
Bruce Davis
Melissa Malkin-Weber

Project Manager
Cyrus Dastur

Research Associates
Maria Mauceri
Arwen Carter

Submitted To:
Parrish Galusky, Project Manager, U.S. Dept. of Energy

Advanced Energy
909 Capability Dr. Suite 2100
Raleigh, NC 27606
www.advancedenergy.org
919-857-9000

DISCLAIMER

This report was prepared as an account of work sponsored by an agency of the United States Government. Neither the United States Government nor any agency thereof, nor any of their employees, makes any warranty, express or implied, or assumes any legal liability or responsibility for the accuracy, completeness, or usefulness of any information, apparatus, product, or process disclosed, or represents that its use would not infringe privately owned rights. Reference herein to any specific commercial product, process, or service by trade name, trademark, manufacturer, or otherwise does not necessarily constitute or imply its endorsement, recommendation, or favoring by the United States Government or any agency thereof. The views and opinions of authors expressed herein do not necessarily state or reflect those of the United States Government or any agency thereof.

TABLE OF CONTENTS

1. Acknowledgements
2. Executive Summary
3. Introduction
4. Experimental Design
 - 4.1 Protocol Development
 - 4.2 Research site description
 - 4.2.1 Overview Flagstaff, AZ site
 - 4.2.2 Overview of Baton Rouge, LA site
 - 4.2.3 Overview of Greenwood, DE site
 - 4.3 Research Variables
 - 4.4 Construction Variables
 - 4.4.1 Pre-construction variables
 - 4.4.2 Construction Schedule Variables
 - 4.4.3 Instrumentation and Monitoring
5. Procedures and Methods
 - 5.1 Experimental Assignment
 - 5.1.1 Flagstaff, AZ
 - 5.1.2 Baton Rouge, LA
 - 5.1.3 Greenwood, DE
 - 5.2 Installation Protocols for closed crawl spaces
 - 5.2.1 Flagstaff, AZ
 - 5.2.2 Baton Rouge, LA
 - 5.2.3 Greenwood, DE
 - 5.3 Data collection Equipment
 - 5.3.1 Temperature, Relative Humidity, and Dew Point
 - 5.3.2 Radon
 - 5.3.3 Gas and Electric Sub-metering
 - 5.4 Data Acquisition Protocols
 - 5.5 Data Analysis Protocols
6. Results
 - 6.1 Flagstaff Site
 - 6.1.1 Installation
 - 6.1.2 Energy Consumption
 - 6.1.3 Temperature, Relative Humidity, and Dew Point
 - 6.1.4 Radon
 - 6.1.5 Moisture
 - 6.2 Baton Rouge Site
 - 6.2.1 Installation
 - 6.2.2 Energy Consumption
 - 6.2.3 Temperature, Relative Humidity, and Dew Point
 - 6.2.4 Radon
 - 6.2.5 Moisture
 - 6.3 Greenwood Site
 - 6.3.1 Installation

- 6.3.2 Energy Consumption
- 6.3.3 Temperature, Relative Humidity, and Dew Point
- 6.3.4 Radon
- 6.3.5 Moisture
- 7. Findings
- 8. Recommendations
- 9. References (listed in CMR)
- 10. Appendix
 - 10.1 Photographs of Flagstaff, AZ Research Site
 - 10.2 Photographs of Baton Rouge, LA Research Site
 - 10.3 Photographs of Greenwood, DE Research Site

1. ACKNOWLEDGEMENTS

This report was prepared with the support of the U.S. Department of Energy, under Award No. DE-FC26-04NT42319. However, any opinions, findings, conclusions, or recommendations expressed herein are those of the author(s) and do not necessarily reflect the views of the DOE.

2. EXECUTIVE SUMMARY

Advanced Energy has recently completed jointly funded research with the Department of Energy that has demonstrated the substantial energy efficiency and moisture management benefits of using closed crawl space foundations for home construction versus the traditional use of wall vented foundations. In an effort to explore the energy efficiency of closed crawl spaces further, the researchers from the first project, presented additional questions to the Department of Energy and subsequently began work on the Marketplace Performance Crawl Space Project (the Project). The Project is based on four main questions:

- (1) Can closed crawl space technology offer energy savings and/or moisture control in climate areas outside of eastern North Carolina's mixed humid climate?
- (2) Can this result be achieved in the production home builder marketplace?
- (3) Can a business supply chain be established that will for its own financial self interest grow the use of these improved construction methods in the marketplace?
- (4) Can popular energy modeling applications successfully predict the energy consumption for closed crawl spaces?

These research questions will be addressed in three technical reports:

1. Housing Characteristics Report (HCR),
2. Business Supply Chain Commercialization Report (BSCCR) and
3. Computer Modeling Report (CMR).

Housing Characteristics Report

The Housing Characteristics Report (HCR) documents the steps taken to establish three research sites. Each site is outside of North Carolina and in differing climate zones. The builder and research team will select 12 houses at each site to participate (each will be monitored for temperature, relative humidity, dew point, radon and gas and electric space conditioning equipment will be sub-metered for energy consumption): four with traditional wall vented crawl spaces, four with closed crawl spaces and insulation between floor joists, and four closed crawl spaces with insulation on the walls. One additional house will be built at one of the sites with a closed crawl space with both floor and wall insulation.

All research homes at each site will be built by a production builder. In addition to answering the quantitative questions about the performance of the test homes this report also aims to document the ability of the technology to fit into a production builder's schedule. Tasks 1.1-1.7 and 2.1.-2.5 listed below describe the specific tasks reported.

Business Supply Chain Commercialization Report

In the BSCCR, researchers explore the existing marketplace for closed crawl spaces and what is needed to encourage the technology’s growth in each of the three research site markets. The research team will recruit industry partners: builders, suppliers and manufacturers of products, distributors and installers of products, trainers, and local building science resources. The industry partners will sit on a Market Place Committee to help guide the project and help insure the market will benefit. Tasks 1.1-1.3 and 4.1-4.6 listed below describe the specific tasks reported.

Computer Modeling Report

Applying the energy usage results from the HCR, the CMR compares and explores the effectiveness of a variety of popular modeling applications to predict how a closed crawl space will affect the heating and cooling load of a home. Each test house will be sub-metered for gas and electricity consumption used for space conditioning. Actual energy consumption results will be compared to the computer models predictions. In addition to tasks 3.1-3.4 this report also describes a preliminary assessment based on data from the 2005 North Carolina research project comparing a large number of energy modeling applications against each other to determine the most accurate and usable sub-set of programs which will be used to analyze the houses enrolled in the current project.

	Budget Period 1 *				Budget Period 2				Budget Period 3			
	1	2	3	4	1	2	3	4	1	2	3	4
Reports & Briefs												
COR briefing												
Monthly report												
Quarterly report												
Final report												
Tasks												
1. Marketplace Performance Sites												
1.1 Form and utilize MPC												
1.2 Recruit builders												
1.3 Develop materials												
1.4 Develop protocols												
1.5 Practice installations												
1.6 Schedule construction												
1.7 Deliver homes												
2. Marketplace Performance Study												
2.1 Finalize analysis method												
2.2 Install metering												
2.3 Retrieve performance data												
2.4 Analyze results												
2.5 Report house characteristics												
3. Computer Model												

3.1 Enter data into models													
3.2 Generate predictions													
3.3 Compare predictions to actual													
3.4 Report computer modeling													
4. Commercialization Assessment													
4.1 Assess bus. supply chain													
4.2 Assess costs, benefits													
4.3 Report commercialization													
4.4 Publish journal articles													
4.5 Present at conferences													
4.6 Create web material													

* Note that Budget Period I received two no-cost extensions to accommodate hiring of project staff and slower-than-expected recruitment of participating builders. Budget Period I was extended to run eight quarters from October 1, 2004 to October 30, 2006.

This, the Housing Characteristics Report (HCR), is the first of the three reports. The HCR is intended to provide the construction and research communities a broader understanding of how properly closed crawl space systems perform in mainstream housing types in a variety of geographical locations in the United States.

The research team began recruiting builders in 2005. The research team met with and interviewed over 13 builders and 29 industry colleagues in order to identify and secure research agreements with three suitable partners. As a result of these communications, the research team partnered with builders in Flagstaff, AZ, Greenwood, DE and Baton Rouge, LA.

However, at the end of Budget Period 1, the DOE indicated that full funding would not be available for the remainder of the project. As the project transitioned to funding by the National Center for Energy Management and Building Technologies (NCEMBT) in March 2007, inadequate funding was available to continue with all three sites. The Greenwood builder had encountered delays in construction and desired to change its construction designs from those approved for the project, so researchers and the builder decided to end their participation in the project. This report retains the background information and description of the work completed with the Greenwood builder prior to ending participation in the project.

According to the climate zone map provided by the Department of Energy’s Building America program (Climate Zone Map, 2006). Flagstaff has a cold climate, Baton Rouge, LA has a hot-humid climate and Greenwood, DE has a mixed-humid climate. This distribution of research sites allows researchers to document the performance of closed crawl space systems and their impact on home heating and cooling energy use in a heating-dominated climate, a cooling-dominated climate, and a balanced climate with a significant summer moisture load.

Except for the short “monsoon” season, (July through September), Flagstaff receives very little rain (Monsoon, 2006). Because of the generally low humidity, researchers do not expect to encounter the chronic moisture problems suffered by crawl spaces in the

Southeast and other humid climates. However, the monsoon season presents significant short-term water impacts that are anecdotally reported to cause moisture problems in traditional vented crawl spaces in the region, so performance during these periods will be closely scrutinized.

For the Flagstaff research site researchers have partnered with the builder, an installer, multiple manufacturers and suppliers, and a trainer. Working with these partners the research team has secured local code body approval for the research project and has tested the preliminary specifications and installation protocols for the closed crawl space installations.

Team members have finalized installation specifications with the builder's electrician and plumber for installation of gas and electric sub-meters on the heating and cooling equipment. Seven of the twelve homes participating in the Project have been constructed at the Flagstaff site, and all have been equipped with gas and electric sub-meters. Temperature and humidity loggers have been installed in four finished closed crawl spaces as well as in one completed wall vented crawl space. Builders at the Flagstaff site originally agreed to build one additional test house having a closed crawl space with insulation in both the framed floor structure as well as on the crawl space perimeter wall. The evaluation of this house, although statistically insignificant, would have provided an exploratory indication of performance for this insulation configuration and may have provided insight on heat losses. Unfortunately, the builder has since determined that they will be unable to complete to this additional house.

The Baton Rouge site developer is Habitat for Humanity of Greater Baton Rouge and the homes for this site are modular units built by Palm Harbor Homes of Addison, TX. Local site construction was managed by Audubon General Contractors, and Florida Solar Energy Center is providing energy certification. The research team has held several conference calls with Palm Harbor and also completed site visits to review preliminary foundation designs with Audubon and Palm Harbor, identify modifications needed for the research configurations, inform local code officials of the project, and monitor construction to ensure that necessary steps for the crawl spaces were being completed. There are 15 homes at the Baton Rouge site that will be participating in the Project. Construction on all homes has been completed and they have been prepared for the closed crawl spaces and sub-meters to be installed.

The Greenwood site developer and builder was to be 36 Builders. The research team completed a site visit and several follow-up communications to begin specifying the foundation systems and installation processes. After speaking with the local code officials, they approved of the Project, and construction of the first five homes has began; however, conversations leading up to and during a February visit indicated that the builder was significantly behind the schedule needed for participation in the Project due to the builder's desire to change construction details. As noted above, coupled with a lack of adequate funding for three field sites, this builder ended participation in the project in February 2007.

3. INTRODUCTION

This research will evaluate the performance of houses constructed by industry partners, with their own funds, in geographically dispersed locations outside of North Carolina. This Project is a follow up study to a previously completed project. In 2000, the U.S. Department of Energy funded Advanced Energy to establish a 12-house research site in order to test the performance of homes with closed versus wall-vented crawl spaces in single-family, detached residential structures in eastern North Carolina. Those small (1,040 square feet), simply designed homes have been continuously monitored since 2001. The results show that the homes with closed crawl spaces have a 15-18% decrease in annual energy used for heating and cooling occupied space. This is compared to identical homes built on traditional wall-vented crawl spaces – a major reduction in energy use for the homeowner.

Due to the fact that the first project has been so successful, researchers want to find out how well closed crawl space technology works when house geometry is altered, geographical conditions are different, and the systems are installed in the production builder environment. Homes in a mixed-humid climate, like that of Eastern North Carolina, benefit greatly from having a properly closed crawl space. It not only tempers the area where the HVAC equipment is commonly located, resulting in a reduction of energy use, but it also helps prevent humid air from entering the crawl space and condensing on cooler surfaces. Condensation can result in damaged mechanical equipment and compromised wood framing. However, it is still unconfirmed whether or not closed crawl spaces constructed in other climates in the production builder environment will see the same benefits. The purpose of this task of the project is to answer those performance questions.

4. EXPERIMENTAL DESIGN

There are to be two different Project sites. The minimum plan for each site is to have 12 production houses, with typically four of the houses set up as controls with traditional wall vented crawl space foundations, four houses set up with closed crawl space foundations with insulation in the framed floor structure and four houses set up with closed crawl space foundations with insulation on the crawl space perimeter wall. Thus the primary difference between the control houses and the experiment houses at each site will be the type of crawl space foundation. Other building performance characteristics like duct and envelope leakage will be measured and adjusted, if necessary, to balance performance across the experimental and control groups. General building specifications like insulation R-values, window specifications, etc. will be made as similar as possible, if not identical, for all houses at a given research site. When the houses at either research site are not built from the identical construction plan, variables like square footage and volume will be balanced when the houses are placed into the experimental groups. This grouping process is intended to reduce uncertainty that differences between the experimental groups in space conditioning energy consumption will be attributable to the application of closed crawl space technology.

Each house will be sub-metered for conditioned space cooling and heating energy use and will have temperature and relative humidity recorded [allowing for dew point calculation] in the crawl space, outside, and in the house. Radon concentrations will be recorded in the crawl space and in the house. Home construction is planned to take approximately six months during which time some data collection equipment is installed to help researchers understand conditions and building performance during construction. After construction the remaining data collection equipment is installed and activated. Once every house participating in the study at a single research site is completed, a 12-month data collection period takes place. During this time researchers visit each site at least once every three months to check on the conditions and download data.

Two key parts of the Project's, experimental design are establishing a Marketplace Performance Committee (MPC) and establishing the two research sites. The committee's responsibility is to help guide the Project and it is comprised of representatives [Champions] from companies and industries partnered with the Project. Partners to the Project include:

- Production Home Builders
- Manufacturers and Distributors of Closed Crawl Space Materials
- Closed Crawl Space Installers
- Local Building Science Resources

Ideally, the research team will have one of each of the partner resources listed above for each research site. Certain partners may be unnecessary at a specific site, depending on its requirements, or the same partner may be involved at multiple locations.

The Committee, once formally configured, will meet as needed via conference call and/or face to face meetings to discuss the progress of the Project and the future of the closed crawl space marketplace. Additional discussion of the MPC is located in the Commercialization Report, however; a brief description of partners for each site is located in section 4.

4.1 Specification and Protocol Development

Once builder and installer partners were recruited for a given site, the team, along with the partners, began to develop specifications and protocols for installations. After preliminary installation specifications and protocols are developed, supervised installations will be completed to ensure that the installer has an adequate understanding of the process as well as to refine the specifications and protocol.

In addition to the protocols for installation, protocols will be established at each site for installing metering equipment, retrieving data from that equipment and analyzing the results.

4.2 Research Site Descriptions

4.2.1 Flagstaff, Arizona

Flagstaff is located in a cold climate as defined by the U.S. Department of Energy's Building America Program and is also very dry except for the monsoon season. These characteristics make it an interesting location for one of the sites for the MPCs Project. Below are three maps; the first shows the location of the test site (marked as The Retreat), the second is a satellite view of the plat where the houses are located, and the third is a drawing representing the lots and plan numbers for each participating house.



Map 1 Flagstaff (Site marked as The Retreat)



Map 2 Satellite view of area denoted as The Retreat in Map 1

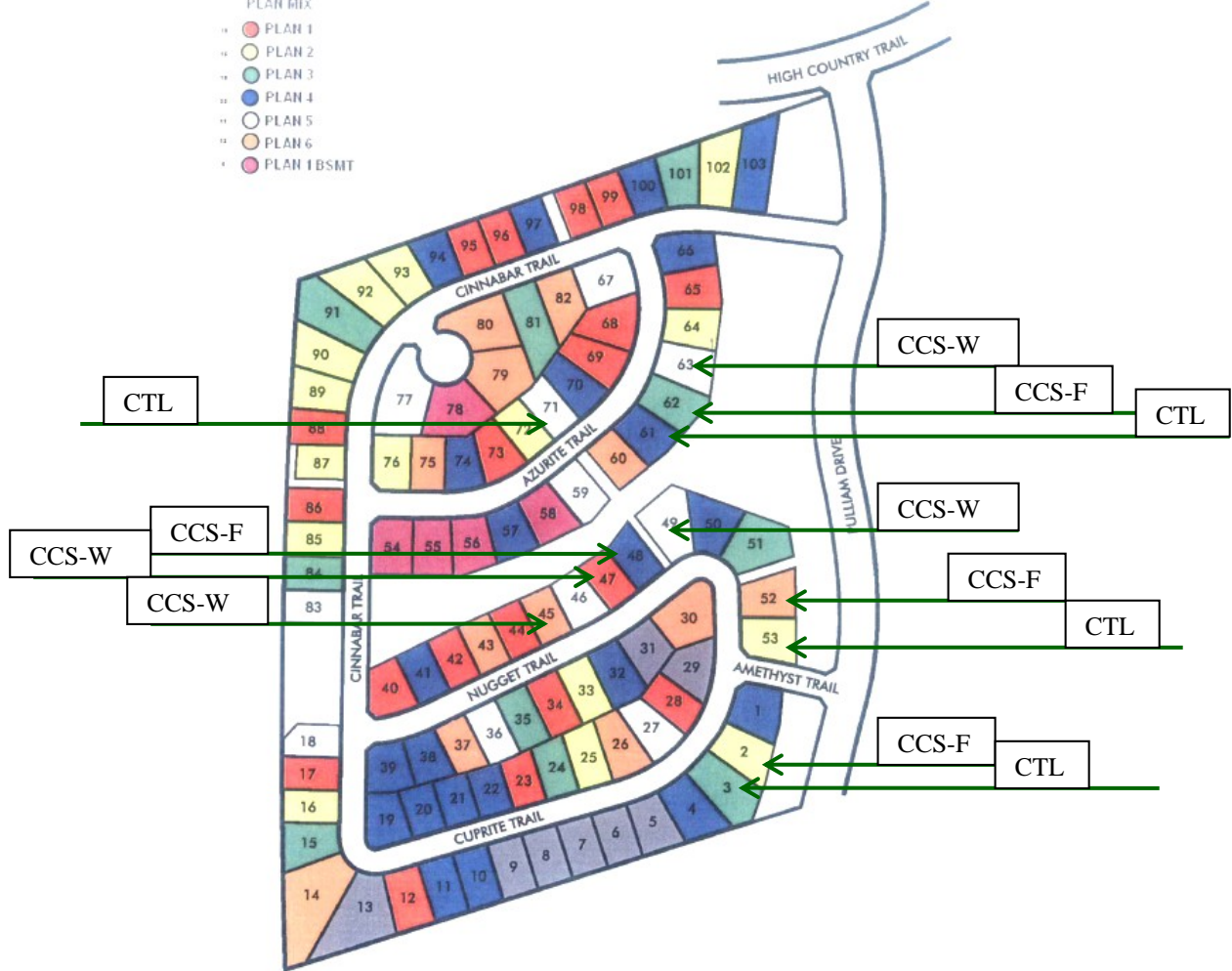

Map 3 Flagstaff (plat plan for satellite image from Map 2)

As can be seen from the lot drawing the participating houses are located within a close proximity of one another. The experimental groups were assigned in such a manner as to account for the differing solar orientations, sizing of floor plans, and amount of glazing. Each house is located on a slight grade, dropping at least 4' from one side to the other, usually from the front of the lot to the back.

4.2.2 Baton Rouge, LA

Baton Rouge is located in a hot-humid climate as defined by the U.S. Department of Energy's Building America Program. The first project documented greater energy savings in the cooling season rather than the heating season making this site ideal for the project. In addition due to its high humidity levels moisture issues in crawl spaces are a frequent problem the area and may be alleviated with the closed crawl space technology.

Habitat for Humanity of Greater Baton Rouge approached the Florida Solar Energy Center (FSEC) to help them develop the most appropriate minimum construction standards for the region. Palm Harbor is a Building America member and will be working with FSEC and Habitat for Humanity of Greater Baton Rouge to build the development that will serve as the pilot for the new standards. The closed crawl space specifications used in this pilot, if proven effective, may become part of this areas new construction standard. Habitat for Humanity of Greater Baton Rouge has chosen a lot in an

established residential and commercial neighborhood for this 15 house pilot project. The project will be built on a reclaimed lot outline in red on Map 4. The lot is located at the corner of Rosenwald Rd. and Lewis St. in Eastern Baton Rouge County, LA. Map 5 shows how the homes will be placed on the plat.

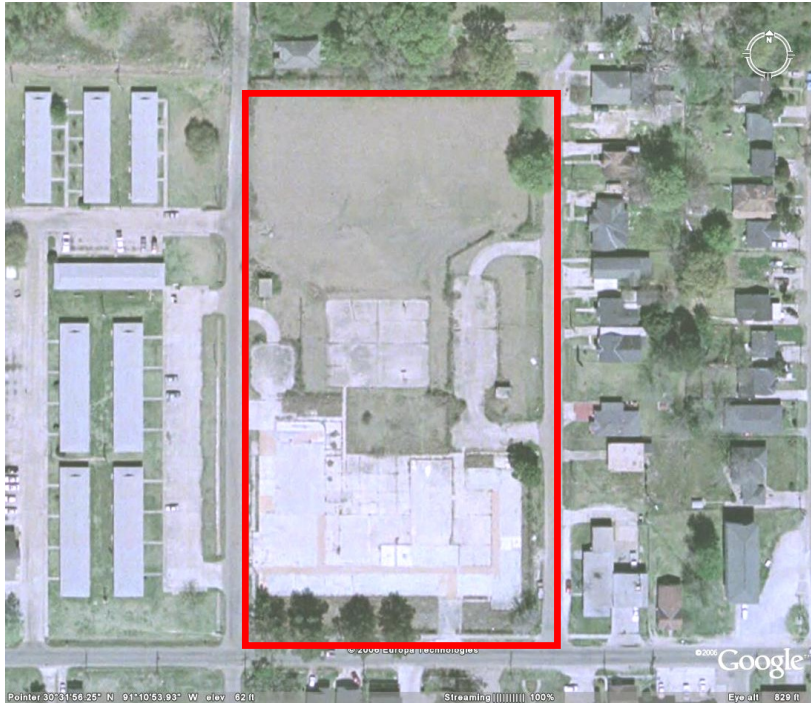

Map 4 Baton Rouge (satellite view of construction site)

Baton Rouge Research Site

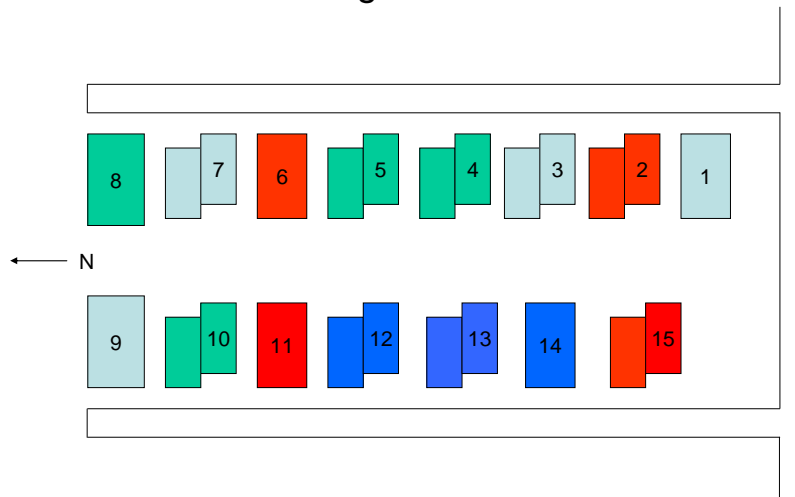

Map 5 Baton Rouge plat plan for satellite image from Map 4. Note that control homes are indicated in red, floor-insulated closed crawl space homes in green, and wall-insulated closed crawl space homes in blue. The darker blue indicates three homes with all supply ductwork in the crawl space. The remaining twelve homes have supply ductwork in the attic.

Habitat for Humanity of Greater Baton Rouge and Palm Harbor Homes has completed all 15 participating houses. Each house will be placed in one of four test groups (outlined in section 5.1.2) based on the research variables described in section 4.3.

4.2.3 Greenwood, DE

Greenwood, DE is located in a mixed-humid climate as defined by the U.S. Department of Energy’s Building America Program. Princeville, NC (the research site from the first project) was also in a mixed-humid climate and documented significant energy savings when applying the closed crawl space technology. The Greenwood site matched the needs of the current Project by offering the same climate zone, as was tested previously, but with more complicated house geometry built by a production builder. Like Baton Rouge, this region also experiences high humidity levels and frequent moisture issues in crawl spaces that may be alleviated by the closed crawl space technology.

4.3 Research Variables

The key to understanding how structures are affected by a change in construction is to normalize as many of the variables between each structure as possible. Many variables outside of foundation design impact the energy efficiency of a residential building. The attributes used to make this comparison are summarized below for each house and used to form test groups with similar characteristics (refer to section 5.1.1 for this summary).

Building Dimensions	Heating Ventilation and Air Conditioning	Building Envelope Specifications
<ul style="list-style-type: none"> • Surface area of building • Volume of building • Number of stories • Total glazing square footage • Type of windows • Glazing areas by orientation 	<ul style="list-style-type: none"> • Equipment specifications • Duct leakage 	<ul style="list-style-type: none"> • Insulation <ul style="list-style-type: none"> ○ Type ○ R-value ○ Placement ○ Installation inspection information (if possible to include) • Air infiltration

It is important to note that in order to eliminate climate as a variable participating houses are only compared to those houses located at each geographic site. For example a study group of houses in Flagstaff will only be compared to the other groups in Flagstaff and will not be compared to any participating research groups in Baton Rouge.

5. PROCEDURES AND METHODS

5.1 Experimental assignment

5.1.1 Flagstaff, Arizona

Empire Communities, the builder in Flagstaff, has recently begun building all of their homes to meet Energy Star requirements. For the project this means that their designs are already being run through an energy modeling program and that on site inspections are required and can be reported to the research team. **Tables 1, 2 and 3** (pg.17) illustrate the grouping based on plan number, square footage, volume of the structure, number of stories and glazing totals.

- **Table 1** - “CTL” details the 4 houses chosen to be in the control group – those with traditional wall vented crawl spaces.
- **Table 2** - “CCS-F” details the 4 houses chosen to be in the group receiving the Closed Crawl Space installation with Floor insulation.
- **Table 3** - “CCS-W” details the 4 houses chosen to be in the group receiving the Closed Crawl Space installation with Wall insulation.

Orientation is also a factor when deciding how to group the research houses Map 3 denotes the orientation and shows the experimental group assignments. Due to construction schedules three of the participating houses, lots 61, 62, and 63, were constructed before Empire began building to Energy Star requirements and partnered with the Project. The builder agreed to upgrade the furnaces in these three homes to the same 90+ AFUE direct vented furnace models used in subsequent houses. This ensured that every research home will have the same mechanical equipment efficiency and also ensures proper exhaust of combustion by-products from the furnace to the outside of the closed crawl space. The one remaining difference between these three homes and the others in the test groups is that they do not have Energy Star, Low-E windows. Each of the three houses with lower-grade windows are similar with regard to the remaining variables, so researchers have placed one of these houses in each of the experimental groups to reduce bias.

All the participating houses in Flagstaff have the same insulation types and values throughout the structure. E3 Energy, the local building science company working with the project completes insulation installation inspections to ensure each house has properly installed insulation. After construction the air infiltration and duct leakage are tested to make sure they are within acceptable tolerances for the Energy Star Program and the crawl space research Project.

Table 1

	Lot	Plan	Floor	Volume	Stories	East	South	West	North	Total
CTL	3	3	1910	17343	1	127	94	39	66	326
CTL	71	1	1595	14483	1	31	50	63	141	285
CTL	53	2	1864	16925	1	132	68	51	50	301
CTL	61	4	2223	21999	2	148	34	89	48	319
Total			7592	70750		438	246	242	305	1231

Table 2

	Lot	Plan	Floor	Volume	Stories	East	South	West	North	Total
CCS-F	2	2	1864	16925	2	132	68	51	50	301
CCS-F	48	4	2223	21999	2	34	89	48	148	319
CCS-F	52	6	2776	27780	2	209	33	82	82	406
CCS-F	62	3	1910	17343	1	127	94	39	66	326
Total			8773	84047		502	284	220	346	1352

Table 3

	Lot	Plan	Floor	Volume	Stories	East	South	West	North	Total
CCS-W	45	6	2776	27780	1	33	82	82	209	406
CCS-W	47	1	1595	14483	1	31	50	63	141	285
CCS-W	49	5	2228	20230	2	68	49	50	130	297
CCS-W	63	5	2228	20230	2	130	68	49	50	297
Total			8827	82723		262	249	244	530	1285

5.1.2 Baton Rouge, LA

All of the homes at the Baton Rouge site have been completed. Habitat of Humanity of Greater Baton Rouge is working with the Florida Solar Energy Center to ensure each meets Energy Star requirements. For the project this means that their designs are already being run through an energy modeling program and that on site inspections are required and can be reported to the research team. Tables 4, 5, 6, and 7 below, illustrate the grouping based on plan number, square footage, volume of the structure, number of stories and glazing totals. Orientation is also a factor when deciding how to group the research houses Map 5 denotes the orientation and shows the experimental group assignments.

Table 4

**Wall-vented crawl space
(Control)**

	Lot	Plan	Floor	Volume	Stories	East	South	West	North	Total
CTL	2	Dumaine 3BR St.	1144	9152	1	60	60	25	45	190
CTL	6	Charles 3BR	1144	9152	1	45	60	25	45	175

CTL	11	St. Charles 3BR	1144	9152	1	25	45	45	60	175
CTL	15	Dumaine 3BR	1144	9152	1	25	45	60	60	190
Total			4576	36608		155	210	155	210	730

Table 5
Closed crawl space with insulation
in framed floor

	Lot	Plan	Floor	Volume	Stories	East	South	West	North	Total
CCS-F	10	Dumaine 3BR	1144	9152	1	25	45	60	60	190
CCS-F	5	Dumaine 3BR	1144	9152	1	60	60	25	45	190
CCS-F	4	Dumaine 3BR	1144	9152	1	60	60	25	45	190
CCS-F	8	St. Charles 4BR	1352	10816	1	45	60	25	45	175
Total			4784	38272		190	225	135	195	745

Table 6
Closed crawl space with perimeter wall insulation and supply ducts in attic

	Lot	Plan	Floor	Volume	Stories	East	South	West	North	Total
CCS-W-A	1	St. Charles 3BR	1144	9152	1	45	60	25	45	175
CCS-W-A	3	Dumaine 3BR	1144	9152	1	60	60	25	45	190
CCS-W-A	7	Dumaine 3BR	1144	9152	1	60	60	25	45	190
CCS-W-A	9	St. Charles 4BR	1352	10816	1	25	45	45	60	175
Total			4784	38272		190	225	120	195	730

Table 7
Closed crawl space with perimeter wall insulation and supply ducts in crawl
space
Group

4	Lot	Plan	Floor	Volume	Stories	East	South	West	North	Total
CCS-W-C	13	Dumaine 3BR	1144	9152	1	25	45	60	60	190
CCS-W-C	12	Dumaine 3BR	1144	9152	1	25	45	60	60	190
CCS-W-C	14	St. Charles 4BR	1352	10816	1	25	45	45	60	175
Total			3640	29120		75	135	165	180	555

There are enough remaining homes to add a third experimental group of three closed crawl space houses. The standard HVAC design for these homes is to have a package unit heat pump installed adjacent to the crawl space wall, with supply and return trunks passing through the crawl space and then up to the attic for distribution. The first eight experimental homes with this duct design will have closed crawl spaces, four with insulation in the floor structure and four with insulation on the crawl space perimeter wall. In the three additional experiment homes, the crawl spaces will be configured as closed crawl spaces with perimeter wall insulation but instead of supply ducts in the attic, the supply ducts will be located inside the crawl space.

5.2 Installation Specifications and Protocols for Closed Crawl Spaces

Installation specifications for each research site depend both on the location (i.e. materials available and climate-specific requirements) and builder specifications (i.e. construction details and process). However; from a standpoint of safety and durability there are specifications for each closed crawl space that we plan to be the same from site to site. Every closed crawl space must have a 100% ground vapor retarder with the seams overlapped and sealed. All the vents must be air-sealed and a vapor retarder will cover the wall with the exception of a 3" termite inspection gap at the top. The liner on the wall is extended 1' on to the ground and the ground vapor retarder is lapped over the wall vapor retarder. All seams on the floor and walls must be sealed. Each crawl space, both closed and vented must be equipped with data collection equipment to monitor relative humidity, temperature, dew point, radon, and HVAC electricity and gas usage.

Another similarity that every site has is one of timing. The research team must work with each builder and installer to figure out and explore the pros and cons of the different processes of installations. Some installers prefer to put in some of the closed crawl space materials before the structure is dried in (a roof is put on), while others prefer to wait until everything is finished to install the closed crawl space. Below is a description of how installations were completed at each of the research sites. The description also lists tools and materials used.

5.2.1 Flagstaff

Research staff, along with installers from E3 Energy worked at the Flagstaff site May 30-Jun 1. The team installed the first two closed crawl space systems and is now evaluating the process. Following the on-site work, project partners reviewed and assessed project logistics (e.g. material shipments, installation specifications and protocol, etc) to determine if there were areas that needed improvement.

Installation protocols are determined before any closed crawl spaces are actually installed therefore it is necessary to make adjustments to them as additional aspects are learned. One example of this is: One of the houses the MPCs partner team had installed a closed crawl space was not yet dried in. After the installation, Flagstaff experienced a heavy rain that washed dirt debris on to the liner on the floor of the crawl space. In addition, the ground vapor retarder put in place during the construction process proved susceptible to

damage from other sub-contractors' foot traffic because of the coarse nature of the ground in the crawl spaces. After these issues were brought to the attention of the research team new protocols were developed by working with the builder and installer. The new protocols recommend that the floor vapor retarder be installed later in the construction process to minimize such damage, and that the builder install finer gravel fill in the crawl space to help reduce the risk of damage.

After observing the first closed crawl space installations the researchers and installer changed the installation sequence to limit weather exposure and damage to the ground vapor retarder. The project staff has also installed Hobo Pro temperature and relative humidity data loggers in the crawl spaces of four project houses to measure humidity levels, temperature and dew point during the remainder of the construction process. One additional logger was placed outside under a deck in a rain shield to monitor ambient conditions.

Included below are the final specifications used for installing the closed crawl spaces. Both sets of protocols (one for an installation with wall insulation and one for an installation with floor insulation) were updated for the Flagstaff site after the first two closed crawl spaces were completed. This was done so that the protocols could incorporate lessons learned from the first installations. The new protocols were used for the last three installations and will be used for the remainder as well.

Specifications for closed crawl space with floor insulation at Flagstaff, Arizona

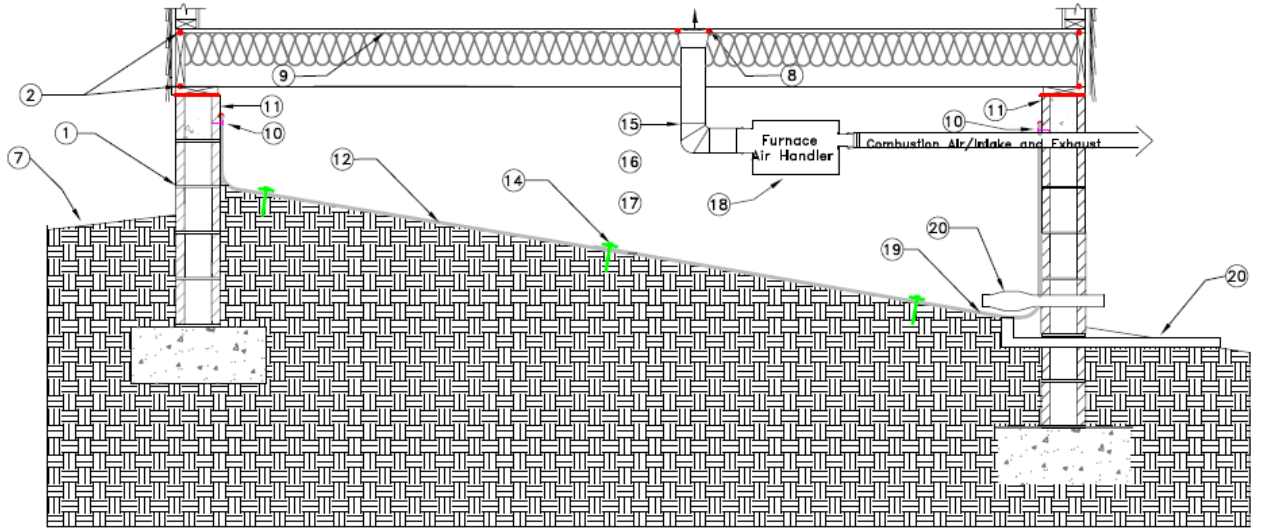

Closed Crawl Space with Floor Insulation

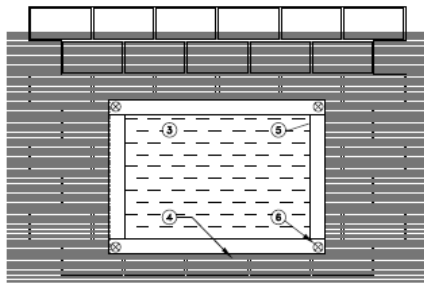

Access Panel Detail for Closed Crawl Space

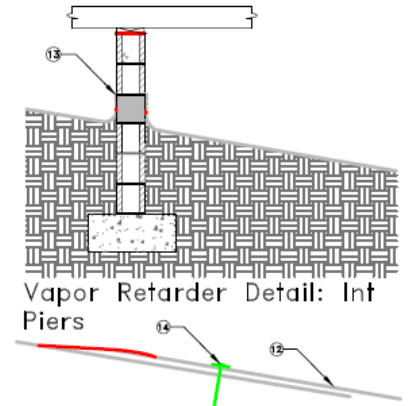

Vapor Retarder Detail: Int Piers

Ground Vapor Retarder Lapping Detail

- 1.** Air seal all foundation stem wall penetrations with weather-resistant caulk, silicone sealant or spray foam.
- 2.** Air seal the mating surfaces at the top and bottom of the sill plate and at the top and the bottom of the band joist. Material options are sill seal gasket, weather resistant caulk or silicone sealants, Dow Froth-Pak 25FS or equivalent spray foam (interior only) or construction adhesive.
- 3.** The frame and body of the crawl space access panel are to be made of pressure-treated wood materials approved for masonry contact or equivalent.
- 4.** Locate the crawl space access opening such that the bottom edge of the opening is a minimum of 6" above exterior and interior finished grades.
- 5.** Weather-strip the crawl space access panel.
- 6.** Secure the crawl space access panel with four exterior-grade wood screws or equivalent.
- 7.** Slope the exterior grade away from the foundation stem wall per local code.
- 8.** Air seal all duct, plumbing, electrical, cable and other penetrations through the sub-floor per local fire-blocking requirements or with any combination of metal flashing, duct mastic, or fire-stop caulk.
- 9.** Insulate floor joist cavities with R-30 batt insulation. Install the insulation in full contact with the subfloor and ensure that it is secured in place. Install the insulation without gaps, voids, or compression.
- 10.** Attach 6 mil thick, translucent, fiberglass-reinforced wall vapor retarder material to the foundation stem wall with Hilti X-GN 20MX or equivalent masonry fasteners driven through Hilti 23MM GX 100 or equivalent washers. The fastener and washer combo shall be installed in a single row within 4" of the top edge of the vapor retarder. At least one fastener and washer combo shall be installed within 6" of each corner in the foundation stem wall. The fastener and washer combo shall be spaced no more than 48" apart. When the wall vapor retarder extends higher than 48" above interior crawl space grade, the fastener and washer combos shall be spaced no more than 36" apart. Install wall vapor retarder to a height such that foundation vents are covered. Install one fastener and washer combo within 6" of each corner of each foundation vent. Overlap seams in the wall vapor retarder material at least 2" and seal the seam with Nail Power or equivalent construction adhesive, Raven Industries 4" wide VaporBond TVB-4 or equivalent tape, or fiberglass mesh tape embedded in mastic. Extend the wall vapor retarder nominally 12" horizontally onto the crawl space floor.

11. Leave a nominal 3" termite inspection gap between the top of the wall vapor retarder and the top of the masonry wall and any untreated wood in contact with the masonry wall (e.g. support beams on pilasters, sill plates, etc.). Seal the edges of the wall vapor retarder to the stem wall with Nail Power construction adhesive or fiberglass mesh tape embedded in mastic or equivalent.

12. Cover 100% of the crawl space floor with minimum 8 mil thick, fiberglass-reinforced polyethylene vapor retarder. Lap the floor vapor retarder material on top of the wall vapor retarder material. When overlapping seams in the field of the ground vapor retarder, ensure that downhill pieces of vapor retarder lap over uphill pieces of vapor retarder. Overlap all seams by a minimum 6" and seal all seams with Raven Industries 4" wide VaporBond TVB-4 or equivalent tape or minimum 4" wide fiberglass mesh tape embedded in mastic. Areas where tape is to be applied must be cleaned of dust and debris prior to application of tape.

13. Attach minimum 6-mil fiberglass reinforced vapor retarder material around each interior pier at least 4" above the crawl space floor. Overlap the seam at least 2". Mechanically attach the vapor retarder to the pier with at least one fastener and washer combo (as defined in item 10) per side. Seal the top edge of the vapor retarder to the pier with Nail Power or equivalent construction adhesive or fiberglass mesh tape and mastic. Seal the seam in the pier vapor retarder and seal the pier vapor retarder to the ground vapor retarder with Raven Industries 4" wide VaporBond TVB-4 or equivalent tape or minimum 4" wide fiberglass mesh tape embedded in mastic.

14. Secure the ground vapor retarder to the crawl space floor with nominal 6" galvanized spikes or turf staples. Install at least one spike or staple within 2' of each corner in the foundation stem wall. If spikes are used, insert the spikes through a minimum 1" diameter plastic or metal washer. If spikes are optionally inserted through a lapped seam, ensure that they are centered in the seam. Seal across the top of any spike/staple penetrations or any other penetrations through the vapor retarder with Raven Industries VaporBond TVB-4 or equivalent tape or mastic.

15. Air seal the heating and cooling ductwork per E3 Energy specifications and insulate the ductwork to R-6.

16. Terminate any water heater drains, temperature/pressure relief pipes, furnace condensate or air conditioner condensate lines outside the crawl space.

17. Terminate all kitchen, bathroom, and clothes dryer vents outside the crawl space.

18. Natural gas-fired furnace and any other combustion appliance in the crawl space must receive all combustion air from outside and exhaust all combustion

gases directly to the outside. Any natural gas regulators, valves, or other fixtures that may vent natural gas must be vented outside the crawl space.

19. Grade the crawl space floor to one low point on the downhill side of the crawl space.

20. Provide a minimum 2" diameter drain pipe through the foundation stem wall at the lowest point of the crawl space floor. Extend this crawl space drain pipe to daylight. The drain intake may pass through the foundation stem wall at crawl space grade level or below. The drain shall be capped with a rodent-excluding screen or grate.

Specifications for closed crawl space with wall insulation at Flagstaff, Arizona

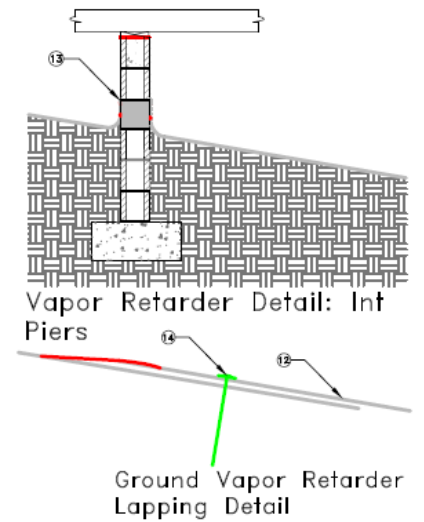
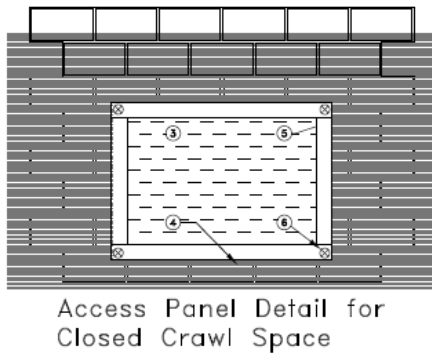
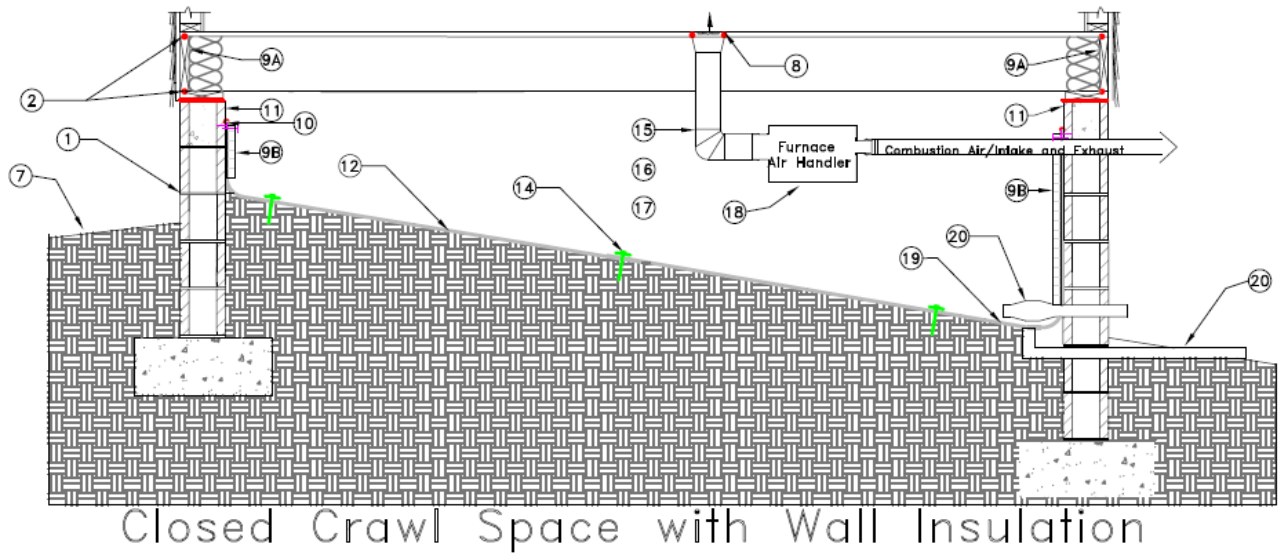

- 1.** Air seal all foundation stem wall penetrations with weather-resistant caulk, silicone sealant or spray foam.
- 2.** Air seal the mating surfaces at the top and bottom of the sill plate and at the top and the bottom of the band joist. Material options are sill seal gasket, weather resistant caulk or silicone sealants, Dow Froth-Pak 25SF or equivalent spray foam (interior only) or construction adhesive.
- 3.** The frame and body of the crawl space access panel are to be made of pressure-treated wood materials approved for masonry contact or equivalent.
- 4.** Locate the crawl space access opening such that the bottom edge of the opening is a minimum of 6" above exterior and interior finished grades.
- 5.** Weather-strip the crawl space access panel.
- 6.** Secure the crawl space access panel with four exterior-grade wood screws or equivalent.
- 7.** Slope the exterior grade away from the foundation stem wall per local code.
- 8.** Air seal all duct, plumbing, electrical, cable and other penetrations through the sub-floor per local fire-blocking requirements or with any combination of metal flashing, duct mastic, or fire-stop caulk.
- 9A.** Insulate the band joist area with friction-fit pieces of R-19 unfaced batt insulation. Install the insulation without voids, gaps, or compression.
- 9B.** Insulate the foundation stem wall with minimum R-13 Dow Thermax insulation or equivalent. Install the insulation in contact with the wall vapor retarder. Secure the insulation to the stem wall with Hilti X-IE 6-50-DI52 type fastener or equivalent. The fasteners shall be installed in two rows per piece of insulation, the first row being within the top quarter of the vertical dimension of the piece and the second row being within the bottom quarter of the vertical dimension of the piece. The top row shall be installed with maximum 48" spacing between fasteners, with at least two fasteners in the top row for each piece. The bottom row shall be installed as one fastener per piece, centered horizontally. Pieces of insulation smaller than 24" x 48" may be installed with only two fasteners. Seal seams in the insulation material with foil tape. Ensure that there is a nominal 3" gap between the insulation and the top of the stem wall or between the insulation and any untreated wood in contact with the masonry wall (e.g. support beams on pilasters, sill plate, etc.). Ensure that there is a nominal 3" gap between the bottom of the Thermax insulation and the finished interior grade of the crawl space.

10. Attach 6 mil thick, translucent, fiberglass-reinforced wall vapor retarder material to the foundation stem wall with Hilti X-GN 20MX or equivalent masonry fasteners driven through Hilti 23MM GX 100 or equivalent washers. The fastener and washer combo shall be installed in a single row within 4" of the top edge of the vapor retarder. At least one fastener and washer combo shall be installed within 6" of each corner in the foundation stem wall. The fastener and washer combo shall be spaced no more than 48" apart. When the wall vapor retarder extends higher than 48" above interior crawl space grade, the fastener and washer combos shall be spaced no more than 36" apart. Install wall vapor retarder to a height such that foundation vents are covered. Install one fastener and washer combo within 6" of each corner of each foundation vent. Overlap seams in the wall vapor retarder material at least 2" and seal the seam with Nail Power or equivalent construction adhesive, Raven Industries 4" wide VaporBond TVB-4 or equivalent tape, or fiberglass mesh tape embedded in mastic. Extend the wall vapor retarder nominally 12" horizontally onto the crawl space floor.

11. Leave a nominal 3" termite inspection gap between the top of the wall vapor retarder and the top of the masonry wall, and between the vapor retarder and any untreated wood in contact with the masonry wall (e.g. support beams on pilasters, sill plate, etc.). Seal the edges of the wall vapor retarder to the stem wall with Nail Power construction adhesive or fiberglass mesh tape embedded in mastic or equivalent.

12. Cover 100% of the crawl space floor with minimum 8 mil thick, fiberglass-reinforced polyethylene vapor retarder. Lap the floor vapor retarder material on top of the wall vapor retarder material. When overlapping seams in the field of the ground vapor retarder, ensure that downhill pieces of vapor retarder lap over uphill pieces of vapor retarder. Overlap all seams by a minimum 6" and seal all seams with Raven Industries 4" wide VaporBond TVB-4 or equivalent tape or minimum 4" wide fiberglass mesh tape embedded in mastic. Areas where tape is to be applied must be cleaned of dust and debris prior to application of tape.

13. Attach minimum 6-mil fiberglass reinforced vapor retarder material around each interior pier at least 4" above the crawl space floor. Overlap the seam at least 2". Mechanically attach the vapor retarder to the pier with at least one fastener and washer combo (as defined in item 10) per side. Seal the top edge of the vapor retarder to the pier with Nail Power or equivalent construction adhesive or fiberglass mesh tape and mastic. Seal the seam in the pier vapor retarder and seal the pier vapor retarder to the ground vapor retarder with Raven Industries 4" wide VaporBond TVB-4 or equivalent tape or minimum 4" wide fiberglass mesh tape embedded in mastic.

14. Secure the ground vapor retarder to the crawl space floor with nominal 6" galvanized spikes or turf staples. Install at least one spike or staple within 2' of each corner in the foundation stem wall. If spikes are used, insert the spikes

through a minimum 1" diameter plastic or metal washer. If spikes are optionally inserted through a lapped seam, ensure that they are centered in the seam. Seal across the top of any spike/staple penetrations or any other penetrations through the vapor retarder with Raven Industries VaporBond TVB-4 or equivalent tape or mastic.

15. Air seal the heating and cooling ductwork per E3 Energy specifications and insulate the ductwork to R-6.

16. Terminate any water heater drains, temperature/pressure relief pipes, furnace condensate or air conditioner condensate lines outside the crawl space.

17. Terminate all kitchen, bathroom, and clothes dryer vents outside the crawl space.

18. Natural gas-fired furnace and any other combustion appliance in the crawl space must receive all combustion air from outside and exhaust all combustion gases directly to the outside. Any natural gas regulators, valves, or other fixtures that may vent natural gas must be vented outside the crawl space.

19. Grade the crawl space floor to one low point on the downhill side of the crawl space.

20. Provide a minimum 2" diameter drain pipe through the foundation stem wall at the lowest point of the crawl space floor. Extend this crawl space drain pipe to daylight. The drain intake may pass through the foundation stem wall at crawl space grade level or below. The drain shall be capped with a rodent-excluding screen or grate.

5.2.2 Baton Rouge

As with the Flagstaff site, installation protocols are determined before any closed crawl spaces are actually installed therefore it is necessary to make adjustments to them as additional aspects are learned. Because the team is willing to make adjustments to the installation protocols during the process a more thorough and useful design will be available to the market.

The project staff has installed Hobo Pro temperature and relative humidity data loggers in the crawl spaces and returns of each of the participating homes. Two outdoor loggers were installed under the decks of two of the participating homes to record outside temperatures and relative humidity. Team members have identified sub-contractors who can install the electric sub-meters, to read electricity consumption for heating and cooling, and are awaiting a bid for installation.

Included below are the specifications planned for installing the closed crawl spaces. Installation is planned to occur in summer 2007. There are three sets of protocols for the Baton Rouge site due to the additional test group. The protocols will be updated as necessary after the installer is trained and installations begin.

Specifications for closed crawl space with floor insulation and Ductwork in the Attic at Baton Rouge, Louisiana

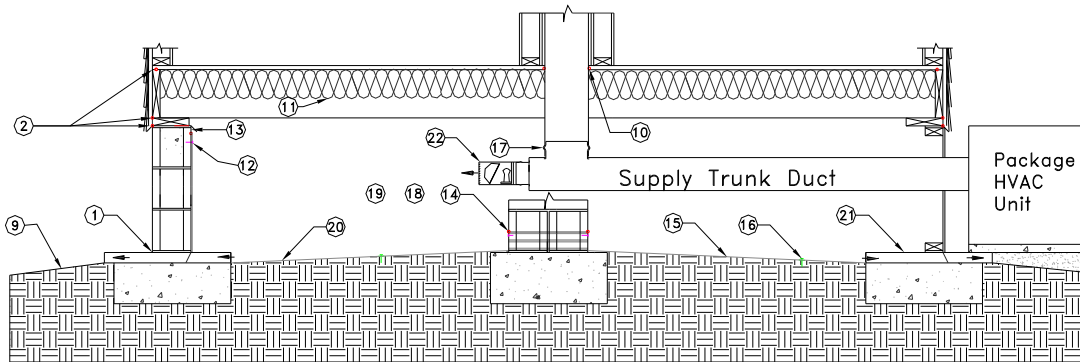

Closed Crawl Space with Floor insulation and Ductwork in the Attic

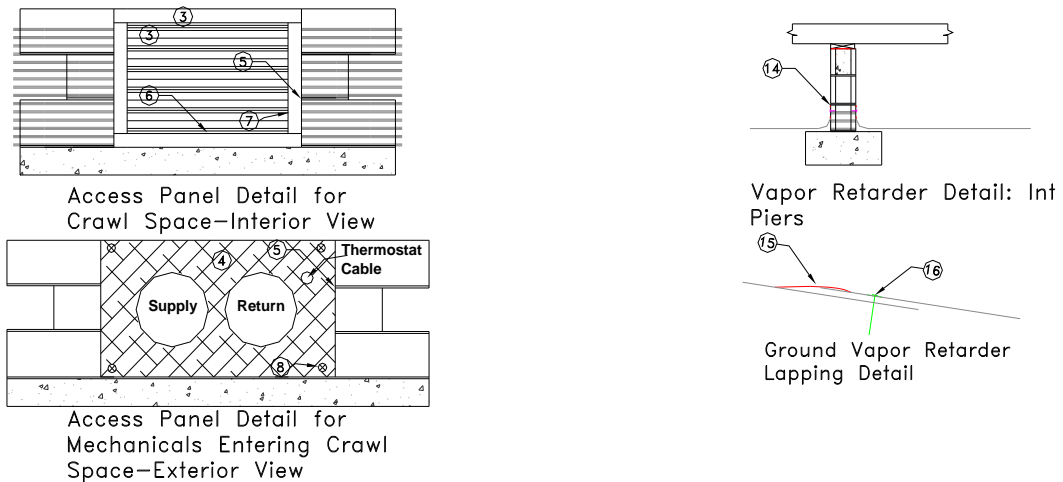

- 1.** Air seal all foundation stem wall penetrations with weather-resistant caulk, silicone sealant or spray foam.
- 2.** Air seal the mating surfaces at the top and bottom of the sill plate and at the top and the bottom of the band joist. Material options are sill seal gasket, weather resistant caulk or silicone sealants, Dow Froth-Pak 25FS or equivalent spray foam (interior only) or construction adhesive.
- 3.** The frame and body of the crawl space access panel are to be made of pressure-treated wood materials approved for masonry contact or equivalent.

- 4.** The frame of the mechanical access panel to the crawl space is to be made of pressure treated wood approved for masonry contact or equivalent and the body is to be made of an approved cementitious material.
- 5.** Both frames are to be sealed to the masonry with an approved exterior grade waterproof sealant.
- 6.** Crawl space access shall be nominally 24" high and 30" wide.
- 7.** Weather-strip the crawl space access panel.
- 8.** Secure the crawl space access panel with four exterior-grade wood screws or equivalent.
- 9.** Slope the exterior grade away from the foundation stem wall per local code.
- 10.** Air seal all duct, plumbing, electrical, cable and other penetrations through the sub-floor per local fire-blocking requirements or with any combination of metal flashing, duct mastic, or fire-stop caulk.
- 11.** Insulate floor joist cavities with R-13 batt insulation. Install the insulation in full contact with the subfloor and ensure that it is secured in place. Install the insulation without gaps, voids, or compression.
- 12.** Attach 6 mil thick, translucent, fiberglass-reinforced wall vapor retarder material to the foundation stem wall with Hilti X-GN 20MX or equivalent masonry fasteners driven through Hilti 23MM GX 100 or equivalent washers. The fastener and washer combo shall be installed in a single row within 4" of the top edge of the vapor retarder. At least one fastener and washer combo shall be installed within 6" of each corner in the foundation stem wall. The fastener and washer combo shall be spaced no more than 48" apart. When the wall vapor retarder extends higher than 48" above interior crawl space grade, the fastener and washer combos shall be spaced no more than 36" apart. Install wall vapor retarder to a height such that foundation vents are covered. Install one fastener and washer combo within 6" of each corner of each foundation vent. Overlap seams in the wall vapor retarder material at least 2" and seal the seam with Nail Power or equivalent construction adhesive, Raven Industries 4" wide VaporBond TVB-4 or equivalent tape, or fiberglass mesh tape embedded in mastic. Extend the wall vapor retarder nominally 12" horizontally onto the crawl space floor.
- 13.** Leave a nominal 3" termite inspection gap between the top of the wall vapor retarder and the top of the masonry wall and any untreated wood in contact with the masonry wall (e.g. support beams on pilasters, sill plates, etc.). Seal the edges of the wall vapor retarder to the stem wall with Nail Power construction adhesive or fiberglass mesh tape embedded in mastic or equivalent.

14. Attach minimum 6-mil fiberglass reinforced vapor retarder material around each interior pier at least 4" above the crawl space floor. Overlap the seam at least 2". Mechanically attach the vapor retarder to the pier with at least one fastener and washer combo (as defined in item 10) per side. Seal the top edge of the vapor retarder to the pier with Nail Power or equivalent construction adhesive or fiberglass mesh tape and mastic. Seal the seam in the pier vapor retarder and seal the pier vapor retarder to the ground vapor retarder with Raven Industries 4" wide VaporBond TVB-4 or equivalent tape or minimum 4" wide fiberglass mesh tape embedded in mastic.

15. Cover 100% of the crawl space floor with minimum 8 mil thick, fiberglass-reinforced polyethylene vapor retarder. Lap the floor vapor retarder material on top of the wall vapor retarder material. When overlapping seams in the field of the ground vapor retarder, ensure that downhill pieces of vapor retarder lap over uphill pieces of vapor retarder. Overlap all seams by a minimum 6" and seal all seams with Raven Industries 4" wide VaporBond TVB-4 or equivalent tape or minimum 4" wide fiberglass mesh tape embedded in mastic. Areas where tape is to be applied must be cleaned of dust and debris prior to application of tape.

16. Secure the ground vapor retarder to the crawl space floor with nominal 6" galvanized spikes or turf staples. Install at least one spike or staple within 2' of each corner in the foundation stem wall. If spikes are used, insert the spikes through a minimum 1" diameter plastic or metal washer. If spikes are optionally inserted through a lapped seam, ensure that they are centered in the seam. Seal across the top of any spike/staple penetrations or any other penetrations through the vapor retarder with Raven Industries VaporBond TVB-4 or equivalent tape or mastic.

17. Air seal the heating and cooling ductwork per Florida Solar Energy Center specifications.

18. Terminate any water heater drains, temperature/pressure relief pipes, furnace condensate or air conditioner condensate lines outside the crawl space.

19. Terminate all kitchen, bathroom, and clothes dryer vents outside the crawl space.

20. Grade the crawl space floor to one low point on the downhill side of the crawl space.

21. Install a 2" positive drain on each side of the crawl space. The drain pipe should extend to daylight and include a ProSet Systems', Trap Guard backflow preventer. The drain intake may pass through the foundation stem wall at crawl space grade level or below. The drain shall be capped with a rodent-excluding screen or grate.

22. Provide a conditioned air supply off the supply trunk with a backflow damper and either a balancing damper or constant airflow regulator to provide airflow of 1 cubic foot per minute per 30 square feet of crawl space floor area.

Specifications for closed crawl space with wall insulation and Ductwork in the Attic at Baton Rouge, Louisiana

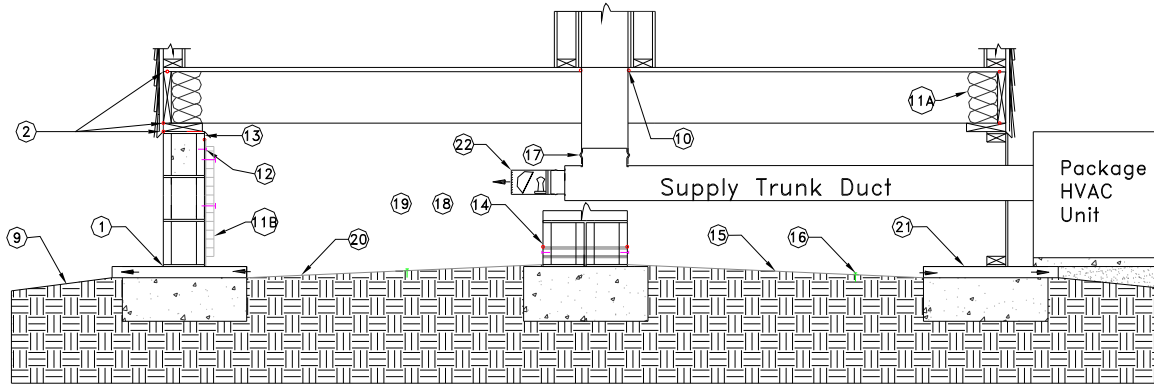

Closed Crawl Space with Wall insulation and Ductwork in the Attic

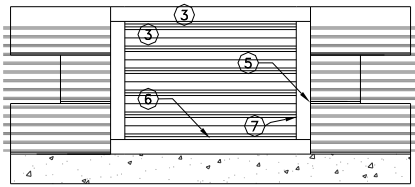

Access Panel Detail for Crawl Space—Interior View

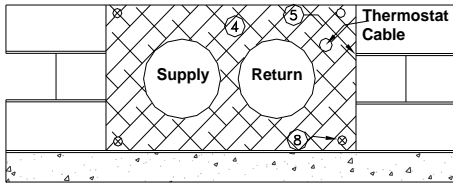

Access Panel Detail for Mechanicals Entering Crawl Space—Exterior View

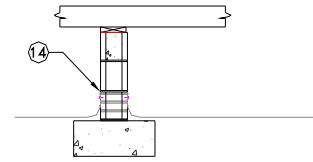

Vapor Retarder Detail: Int Piers

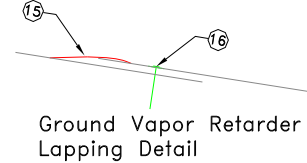

Ground Vapor Retarder Lapping Detail

- 1.** Air seal all foundation stem wall penetrations with weather-resistant caulk, silicone sealant or spray foam.
- 2.** Air seal the mating surfaces at the top and bottom of the sill plate and at the top and the bottom of the band joist. Material options are sill seal gasket, weather resistant caulk or silicone sealants, Dow Froth-Pak 25FS or equivalent spray foam (interior only) or construction adhesive.
- 3.** The frame and body of the crawl space access panel are to be made of pressure-treated wood materials approved for masonry contact or equivalent.

4. The frame of the mechanical access panel to the crawl space is to be made of pressure treated wood approved for masonry contact or equivalent and the body is to be made of an approved cementitious material.

5. Both frames are to be sealed to the masonry with an approved exterior grade waterproof sealant.

6. Crawl space access shall be nominally 24" high and 30" wide.

7. Weather-strip the crawl space access panel.

8. Secure the crawl space access panel with four exterior-grade wood screws or equivalent.

9. Slope the exterior grade away from the foundation stem wall per local code.

10. Air seal all duct, plumbing, electrical, cable and other penetrations through the sub-floor per local fire-blocking requirements or with any combination of metal flashing, duct mastic, or fire-stop caulk.

11A. Insulate the band joist area with friction-fit pieces of R-13 unfaced batt insulation. Install the insulation without voids, gaps, or compression.

11B. Insulate the foundation stem wall with minimum R-8 Dow Thermax insulation or equivalent. Install the insulation in contact with the wall vapor retarder. Secure the insulation to the stem wall with Hilti X-IE 6-50-D152 type fastener or equivalent. The fasteners shall be installed in two rows per piece of insulation, the first row being within the top quarter of the vertical dimension of the piece and the second row being within the bottom quarter of the vertical dimension of the piece. The top row shall be installed with maximum 48" spacing between fasteners, with at least two fasteners in the top row for each piece. The bottom row shall be installed as one fastener per piece, centered horizontally. Pieces of insulation smaller than 24" x 48" may be installed with only two fasteners. Seal seams in the insulation material with foil tape. Ensure that there is a nominal 3" gap between the insulation and the top of the stem wall or between the insulation and any untreated wood in contact with the masonry wall (e.g. support beams on pilaster, sill plate, etc.). Ensure that there is a nominal 3" gap between the bottom of the Thermax insulation and the finished interior grade of the crawl space.

12. Attach 6 mil thick, translucent, fiberglass-reinforced wall vapor retarder material to the foundation stem wall with Hilti X-GN 20MX or equivalent masonry fasteners driven through Hilti 23MM GX 100 or equivalent washers. The fastener and washer combo shall be installed in a single row within 4" of the top edge of the vapor retarder. At least one fastener and washer combo shall be installed within 6" of each corner in the foundation stem wall. The fastener and

washer combo shall be spaced no more than 48" apart. When the wall vapor retarder extends higher than 48" above interior crawl space grade, the fastener and washer combos shall be spaced no more than 36" apart. Install wall vapor retarder to a height such that foundation vents are covered. Install one fastener and washer combo within 6" of each corner of each foundation vent. Overlap seams in the wall vapor retarder material at least 2" and seal the seam with Nail Power or equivalent construction adhesive, Raven Industries 4" wide VaporBond TVB-4 or equivalent tape, or fiberglass mesh tape embedded in mastic. Extend the wall vapor retarder nominally 12" horizontally onto the crawl space floor.

13. Leave a nominal 3" termite inspection gap between the top of the wall vapor retarder and the top of the masonry wall and any untreated wood in contact with the masonry wall (e.g. support beams on pilasters, sill plates, etc.). Seal the edges of the wall vapor retarder to the stem wall with Nail Power construction adhesive or fiberglass mesh tape embedded in mastic or equivalent.

14. Attach minimum 6-mil fiberglass reinforced vapor retarder material around each interior pier at least 4" above the crawl space floor. Overlap the seam at least 2". Mechanically attach the vapor retarder to the pier with at least one fastener and washer combo (as defined in item 10) per side. Seal the top edge of the vapor retarder to the pier with Nail Power or equivalent construction adhesive or fiberglass mesh tape and mastic. Seal the seam in the pier vapor retarder and seal the pier vapor retarder to the ground vapor retarder with Raven Industries 4" wide VaporBond TVB-4 or equivalent tape or minimum 4" wide fiberglass mesh tape embedded in mastic.

15. Cover 100% of the crawl space floor with minimum 8 mil thick, fiberglass-reinforced polyethylene vapor retarder. Lap the floor vapor retarder material on top of the wall vapor retarder material. When overlapping seams in the field of the ground vapor retarder, ensure that downhill pieces of vapor retarder lap over uphill pieces of vapor retarder. Overlap all seams by a minimum 6" and seal all seams with Raven Industries 4" wide VaporBond TVB-4 or equivalent tape or minimum 4" wide fiberglass mesh tape embedded in mastic. Areas where tape is to be applied must be cleaned of dust and debris prior to application of tape.

16. Secure the ground vapor retarder to the crawl space floor with nominal 6" galvanized spikes or turf staples. Install at least one spike or staple within 2' of each corner in the foundation stem wall. If spikes are used, insert the spikes through a minimum 1" diameter plastic or metal washer. If spikes are optionally inserted through a lapped seam, ensure that they are centered in the seam. Seal across the top of any spike/staple penetrations or any other penetrations through the vapor retarder with Raven Industries VaporBond TVB-4 or equivalent tape or mastic.

17. Air seal the heating and cooling ductwork per Florida Solar Energy Center specifications.

- 18.** Terminate any water heater drains, temperature/pressure relief pipes, furnace condensate or air conditioner condensate lines outside the crawl space.
- 19.** Terminate all kitchen, bathroom, and clothes dryer vents outside the crawl space.
- 20.** Grade the crawl space floor to one low point on the downhill side of the crawl space.
- 21.** Install a 2” positive drain on each side of the crawl space. The drain pipe should extend to daylight and include a ProSet Systems’, Trap Guard backflow preventer. The drain intake may pass through the foundation stem wall at crawl space grade level or below. The drain shall be capped with a rodent-excluding screen or grate.
- 22.** Provide a conditioned air supply off the supply trunk with a backflow damper and either a balancing damper or constant airflow regulator to provide airflow of 1 cubic foot per minute per 30 square feet of crawl space floor area.

Specifications for closed crawl space with wall insulation and Ductwork in the Crawl Space at Baton Rouge, Louisiana

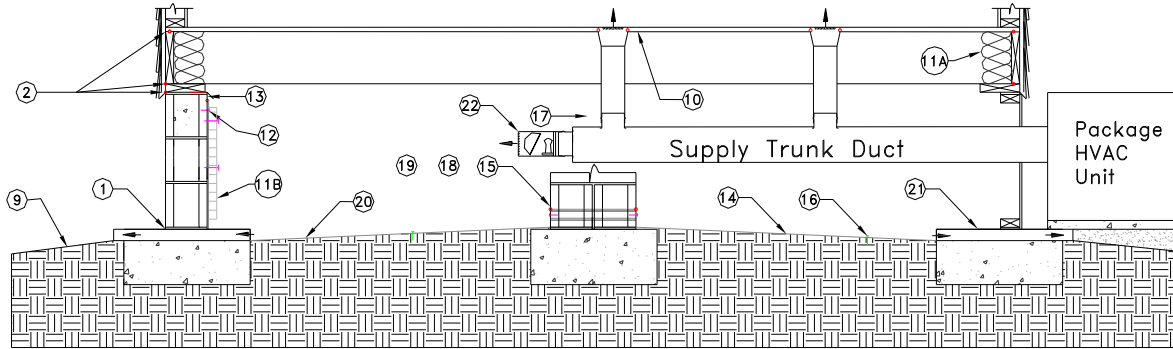

Closed Crawl Space with Wall insulation and Ductwork in the Crawl Space

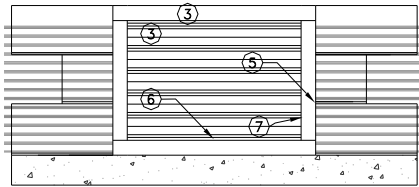

Access Panel Detail for Crawl Space—Interior View

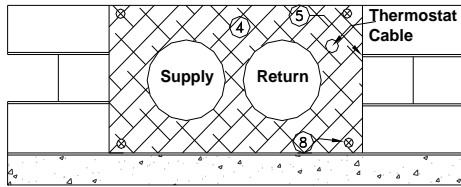

Access Panel Detail for Mechanicals Entering Crawl Space—Exterior View

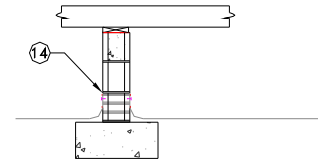

Vapor Retarder Detail: Int Piers

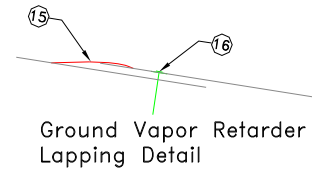

Ground Vapor Retarder Lapping Detail

- 1.** Air seal all foundation stem wall penetrations with weather-resistant caulk, silicone sealant or spray foam.
- 2.** Air seal the mating surfaces at the top and bottom of the sill plate and at the top and the bottom of the band joist. Material options are sill seal gasket, weather resistant caulk or silicone sealants, Dow Froth-Pak 25FS or equivalent spray foam (interior only) or construction adhesive.
- 3.** The frame and body of the crawl space access panel are to be made of pressure-treated wood materials approved for masonry contact or equivalent.

4. The frame of the mechanical access panel to the crawl space is to be made of pressure treated wood approved for masonry contact or equivalent and the body is to be made of an approved cementitious material.

5. Both frames are to be sealed to the masonry with an approved exterior grade waterproof sealant.

6. Crawl space access shall be nominally 24” high and 30” wide.

7. Weather-strip the crawl space access panel.

8. Secure the crawl space access panel with four exterior-grade wood screws or equivalent.

9. Slope the exterior grade away from the foundation stem wall per local code.

10. Air seal all duct, plumbing, electrical, cable and other penetrations through the sub-floor per local fire-blocking requirements or with any combination of metal flashing, duct mastic, or fire-stop caulk.

11A. Insulate the band joist area with friction-fit pieces of R-13 unfaced batt insulation. Install the insulation without voids, gaps, or compression.

11B. Insulate the foundation stem wall with minimum R-8 Dow Thermax insulation or equivalent. Install the insulation in contact with the wall vapor retarder. Secure the insulation to the stem wall with Hilti X-IE 6-50-D152 type fastener or equivalent. The fasteners shall be installed in two rows per piece of insulation, the first row being within the top quarter of the vertical dimension of the piece and the second row being within the bottom quarter of the vertical dimension of the piece. The top row shall be installed with maximum 48” spacing between fasteners, with at least two fasteners in the top row for each piece. The bottom row shall be installed as one fastener per piece, centered horizontally. Pieces of insulation smaller than 24” x 48” may be installed with only two fasteners. Seal seams in the insulation material with foil tape. Ensure that there is a nominal 3” gap between the insulation and the top of the stem wall or between the insulation and any untreated wood in contact with the masonry wall (e.g. support beams on pilaster, sill plate, etc.). Ensure that there is a nominal 3” gap between the bottom of the Thermax insulation and the finished interior grade of the crawl space.

12. Attach 6 mil thick, translucent, fiberglass-reinforced wall vapor retarder material to the foundation stem wall with Hilti X-GN 20MX or equivalent masonry fasteners driven through Hilti 23MM GX 100 or equivalent washers. The fastener and washer combo shall be installed in a single row within 4” of the top edge of the vapor retarder. At least one fastener and washer combo shall be

installed within 6" of each corner in the foundation stem wall. The fastener and washer combo shall be spaced no more than 48" apart. When the wall vapor retarder extends higher than 48" above interior crawl space grade, the fastener and washer combos shall be spaced no more than 36" apart. Install wall vapor retarder to a height such that foundation vents are covered. Install one fastener and washer combo within 6" of each corner of each foundation vent. Overlap seams in the wall vapor retarder material at least 2" and seal the seam with Nail Power or equivalent construction adhesive, Raven Industries 4" wide VaporBond TVB-4 or equivalent tape, or fiberglass mesh tape embedded in mastic. Extend the wall vapor retarder nominally 12" horizontally onto the crawl space floor.

13. Leave a nominal 3" termite inspection gap between the top of the wall vapor retarder and the top of the masonry wall and any untreated wood in contact with the masonry wall (e.g. support beams on pilasters, sill plates, etc.). Seal the edges of the wall vapor retarder to the stem wall with Nail Power construction adhesive or fiberglass mesh tape embedded in mastic or equivalent.

14. Attach minimum 6-mil fiberglass reinforced vapor retarder material around each interior pier at least 4" above the crawl space floor. Overlap the seam at least 2". Mechanically attach the vapor retarder to the pier with at least one fastener and washer combo (as defined in item 10) per side. Seal the top edge of the vapor retarder to the pier with Nail Power or equivalent construction adhesive or fiberglass mesh tape and mastic. Seal the seam in the pier vapor retarder and seal the pier vapor retarder to the ground vapor retarder with Raven Industries 4" wide VaporBond TVB-4 or equivalent tape or minimum 4" wide fiberglass mesh tape embedded in mastic.

15. Cover 100% of the crawl space floor with minimum 8 mil thick, fiberglass-reinforced polyethylene vapor retarder. Lap the floor vapor retarder material on top of the wall vapor retarder material. When overlapping seams in the field of the ground vapor retarder, ensure that downhill pieces of vapor retarder lap over uphill pieces of vapor retarder. Overlap all seams by a minimum 6" and seal all seams with Raven Industries 4" wide VaporBond TVB-4 or equivalent tape or minimum 4" wide fiberglass mesh tape embedded in mastic. Areas where tape is to be applied must be cleaned of dust and debris prior to application of tape.

16. Secure the ground vapor retarder to the crawl space floor with nominal 6" galvanized spikes or turf staples. Install at least one spike or staple within 2' of each corner in the foundation stem wall. If spikes are used, insert the spikes through a minimum 1" diameter plastic or metal washer. If spikes are optionally inserted through a lapped seam, ensure that they are centered in the seam. Seal across the top of any spike/staple penetrations or any other penetrations through the vapor retarder with Raven Industries VaporBond TVB-4 or equivalent tape or mastic.

- 17.** Air seal the heating and cooling ductwork per Florida Solar Energy Center specifications.
- 18.** Terminate any water heater drains, temperature/pressure relief pipes, furnace condensate or air conditioner condensate lines outside the crawl space.
- 19.** Terminate all kitchen, bathroom, and clothes dryer vents outside the crawl space.
- 20.** Grade the crawl space floor to one low point on the downhill side of the crawl space.
- 21.** Install a 2" positive drain on each side of the crawl space. The drain pipe should extend to daylight and include a ProSet Systems', Trap Guard backflow preventer. The drain intake may pass through the foundation stem wall at crawl space grade level or below. The drain shall be capped with a rodent-excluding screen or grate.
- 22.** Provide a conditioned air supply off the supply trunk with a backflow damper and either a balancing damper or constant airflow regulator to provide airflow of 1 cubic foot per minute per 30 square feet of crawl space floor area.

5.3 Data Collection Equipment

Each house will have sensors both in the crawl space and in the house to record temperature, dew point, relative humidity, and radon. Each site will have one or more sensors outside to record temperature, dew point, and relative humidity. In addition, local weather station data will be downloaded if available to characterize outside conditions. All heating and cooling equipment will be sub-metered to determine the exact amount of electricity and/or gas used for space conditioning.

5.3.1 Temperature, Relative Humidity, and Dew Point

Temperature, relative humidity, and dew point are all measured using the same hardware; a HOBO Pro from Onset Computer Corporation. Some of the HOBO Pro's specifications include:

Temperature (internal sensor)

- Range: -30° to 50°C (-22° to 122°F)
- Accuracy: $\pm 0.2^\circ$ at 21°C ($\pm 0.33^\circ$ at 70°F) in high-resolution mode and $\pm 0.5^\circ$ C ($\pm 0.9^\circ$ F) in standard-resolution mode
- Resolution: 0.02° at 21°C (.04° at 70°F) in high-resolution mode and 0.41°C (0.7°F) in standard-resolution mode
- Response time in still air: <35 minutes typical to 90%

Relative humidity:

- Range: 0% to 100% RH*
- Accuracy: $\pm 3\%$ RH over the range of 0 to 50°C (32° to 122°F); ± 4 in condensing environments
- Drift: 1% per year typical; an additional temporary drift up to 3% can occur when the average humidity is above 70%; factory tune-up available
- Response time: 5 minutes typical to 90% (independent of temperature)
- Sensor operating environment: 0° to 50°C (32° to 122°F) in intermittent condensing environments up to 30°C, and above 30°C in non-condensing environments
- Note: Sensor requires protection from rain, splashing, mist, and airborne chemicals such as salt and ammonia.

For each test house one HOBO Pro is installed on a support beam as close to the center of the crawl space as possible and another inside the HVAC return grill inside the house. The crawl space HOBO is not to be installed within five feet of the furnace.

5.3.2 Radon

Radon will be monitored using a long term Alpha Track monitor from AccuStar Labs. AccuStar Labs describes the need for this tool on their website:

According to the EPA, a long-term test is the best way to determine your exposure to Radon during different seasons and living conditions in your home. Closed house conditions are not necessary during a long term test. Leave the test device exposed for 91 days to 12 months under normal living conditions. (AccuStar, 2006)

One long term Alpha Track monitor will be placed in the crawl space as well as the interior of the house. The monitoring period will be no less than 3 months and must span the winter season. Houses are closed more tightly during the winter months, trapping more radon indoors and creating a worst case scenario for researchers to evaluate. Each test kit will be collected at least once during the year of testing. Test kits are sent to AccuStar to be read and results are sent back the MPCS team for monitoring and recording.

5.3.3 Gas and Electric Sub-metering

Electric space conditioning units will be monitored with an I-70-S style single phase residential meter from Austin International. Gas units will be equipped with a Sensus Test Meter (S-275 test series) from Vossler Brothers.

5.4 Data Acquisition Protocols

MPCS research team members are familiar with the data collections tools after completing the first closed crawl space research project and other research endeavors at Advanced Energy. Only Advanced Energy staff will be collecting the data from dataloggers. This is to ensure that the data is downloaded and recorded the same every time and that the dataloggers continue proper operation. At least one team member will visit each research site at least once every three months. During this visit the team member will download the information from each of the HOBO Pros, and record the number on the electric and/or gas sub-meters. After collection, the HOBO information and the sub-meter numbers will be immediately recorded onto the researcher's laptop and compared to the previous quarter's numbers to assure quality control of data. Upon returning to the office this information will be transferred to the appropriate spreadsheet for future analysis.

5.5 Data Analysis Protocols

Data will be stored and analyzed in SAS JMP and/or Microsoft Excel. The MPCS research team will establish protocols for storing the information as well as doing quality assurance.

6. RESULTS

The following outline is included in this Budget Period I report to describe the analysis that will be provided for each research site once the project is complete. Due to the fact that each site is analyzed independently each set of results will be presented in a separate section.

6.1 Flagstaff

6.2 Baton Rouge

6.x.1 Installation

This section will present actual construction schedules that were achieved for each house, grouped by site and experimental group. We will note any significant deviations from planned procedures or methods, if applicable, by location and house.

6.x.2 Energy Consumption

This section will present approaches used, any problems encountered and departure from planned methodology, and an assessment of their impact on the project results.

The energy consumption data collected will be presented in a variety of graphs displaying quarterly averages of:

- Heating/cooling load
- Base load
- Whole house load

6.x.3 Temperature, Relative Humidity, and Dew Point

This section will present approaches used, any problems encountered and departure from planned methodology, and an assessment of their impact on the project results.

The temperature, relative humidity and dew point data collected hourly will be presented in a variety of graphs displaying daily averages of:

- Indoor conditions
- Crawl space conditions
- Ambient conditions

6.x.4 Radon

This section will present approaches used, any problems encountered and departure from planned methodology, and an assessment of the impact on the project results.

The radon data will be collected for a 6–12 month period and total readings will be presented for:

- Indoor pCi/l
- Crawl space pCi/l

6.x.5 Moisture

This section will present approaches used, any problems encountered and departure from planned methodology, and an assessment of their impact on the project results.

The moisture data collected will be from visual inspections and will be presented in a written explanation and pictorially documented for:

- Ground moisture barrier
- Condensation
- Type and operation of wall vents
- Amount of crawl ventilation
- Site grading and drainage
- Rainwater control
- Foundation components
- Below grade walls

7. FINDINGS

This section is reserved to share the findings for each of the test sites. Due to the fact that each site is analyzed on its own each set of findings will be discussed separately.

7.1 Flagstaff

7.2 Baton Rouge

7.x.1 Installation

This section will discuss any interesting finding documented due to the actual construction schedules that were achieved for each house, grouped by site and experimental group.

7.x.2 Energy Performance

This section will present comparisons of energy consumption data collected for each house, grouped by site and experimental group. Comparisons will be presented in a variety of graphs displaying quarterly averages of:

- Heating/cooling load
- Base load
- Whole house load

7.x.3 Temperature, Relative Humidity, and Dew Point

This section will present comparisons of temperature, relative humidity, and dew point data collected for each house, grouped by site and experimental group. Comparisons will be presented in a variety of graphs displaying daily averages of:

- Indoor conditions
- Crawl space conditions
- Ambient conditions

7.x.4 Radon

This section will present comparisons of radon data collected for a 6-12 month period for each house, grouped by site and experimental group. Comparisons will be presented for total readings of:

- Indoor pCi/l
- Crawl space pCi/l

7.x.5 Moisture

This section will present comparisons of the moisture data collected from visual inspections and will be presented in a written explanation and pictorially documented for:

- Ground moisture barrier
- Condensation
- Type and operation of wall vents
- Amount of crawl ventilation
- Site grading and drainage
- Rainwater control
- Foundation components
- Below grade walls

8. RECOMMENDATIONS

The objective of the Housing Characteristics study is to examine the hypothesis that closed crawl space construction offers significant space conditioning energy savings versus traditional vented crawl space construction for houses with a variety of geometric dimensions in different regions of the United States.

The Housing Characteristics study should remain the fundamental activity to be completed in future funded activities as it has been the axis around which all deliverables have been completed to date.

9. REFERENCES

All references are listed in the Computer Modeling Report.

10. APPENDIX

10.1 Photographs of Flagstaff, AZ Research Site



Sign Announcing System



Complete Wall Liner



Properly Sealed Penetrations and Liner



Affixing Wall Liner



Complete Floor Liner and Wrapped Piers



Affixing Thermax



Sealing Floor Liner



Complete System with Floor Insulation



Complete System with Floor Insulation



Raised HVAC System



Air Sealing Band Joist



Liner Sealed to Block Wall

10.2 Photographs of Baton Rouge, LA Research Site



Research Site



View Opposite Research Site

10.3 Photographs of Greenwood, DE Research Site



Example of Participating House – Front View



Example of Participating House – Front View

Business Supply Chain Commercialization Report

Closed Crawl Space Performance:
Proof of Concept in the Production Builder Marketplace

U.S. Department of Energy
Instrument No. DE-FC26-04NT42319

January 11, 2008

Project Directors
Bruce Davis
Melissa Malkin-Weber

Project Manager
Cyrus Dastur

Research Associates
Arwen Carter
Maria Mauceri
Benjamin Hannas

Submitted To:
Parrish Galusky, Project Manager, U.S. Dept. of Energy

Advanced Energy
909 Capability Dr. Suite 2100
Raleigh, NC 27606
www.advancedenergy.org
919-857-9000

DISCLAIMER

This report was prepared as an account of work sponsored by an agency of the United States Government. Neither the United States Government nor any agency thereof, nor any of their employees, makes any warranty, express or implied, or assumes any legal liability or responsibility for the accuracy, completeness, or usefulness of any information, apparatus, product, or process disclosed, or represents that its use would not infringe privately owned rights. Reference herein to any specific commercial product, process, or service by trade name, trademark, manufacturer, or otherwise does not necessarily constitute or imply its endorsement, recommendation, or favoring by the United States Government or any agency thereof. The views and opinions of authors expressed herein do not necessarily state or reflect those of the United States Government or any agency thereof.

TABLE OF CONTENTS

1. Acknowledgements
2. Executive Summary
3. Introduction
4. Experimental Design (Methodology)
 - 4.1 Research Description
 - 4.2 Role of Marketplace Performance Committee
5. Procedures and Methods
 - 5.1 Market Development
 - 5.2 Partner Recruitment
6. Results
 - 6.1 Summary of Interviews with North Carolina Closed Crawl Space Installers
 - 6.1.1 Execution: Methods
 - 6.2.2 Execution: Problems
 - 6.3.3 Ideas
 - 6.2 Partner Recruitment
7. Findings
 - 7.1 Flagstaff, AZ
 - 7.2 Baton Rouge, LA
 - 7.3 Greenwood, DE
8. Recommendations
9. References (listed in CMR)
10. Appendix
 - 10.1 Phone Interview Questionnaire
 - 10.2 Interview Questions for Site Visits
 - 10.3 Official Method for Determining National Benefits

1. ACKNOWLEDGEMENTS

This report was prepared with the support of the U.S. Department of Energy, under Award No. DE-FC26-04NT42319. However, any opinions, findings, conclusions, or recommendations expressed herein are those of the author(s) and do not necessarily reflect the views of the DOE.

2. EXECUTIVE SUMMARY

Advanced Energy completed its first jointly-funded crawl space research project with the Department of Energy in 2005. That project, funded under award number DE-FC26-00NT40995 and titled “A Field Study Comparison of the Energy and Moisture Performance Characteristics of Ventilated Versus Sealed Crawl Spaces in the South” demonstrated the substantial energy efficiency and moisture management benefits that result from using properly closed crawl space foundations for residential construction instead of traditional use of wall vented crawl space foundations. In an effort to further understand the energy efficiency benefit of closed crawl spaces, researchers proposed additional work to the Department of Energy. That proposal was accepted and funded under award number DE-FC26-04NT42319, titled “Closed Crawl Space Performance: Proof of Concept in the Production Builder Marketplace”. We informally refer to this current project as the Marketplace Performance Crawl Space Project (the Project). The Project is intended to explore four research questions:

- (1) Can closed crawl space technology offer energy savings and/or moisture control in climate areas outside of eastern North Carolina’s mixed humid climate?
- (2) Can this result be achieved in the production home builder marketplace?
- (3) Can a business supply chain be established that will for its own financial self interest grow the use of these improved construction methods in the marketplace?
- (4) Can popular energy modeling software applications successfully predict the energy performance of closed crawl spaces?

These research questions will be addressed in three technical reports:

1. Housing Characteristics Report (HCR),
2. Business Supply Chain Commercialization Report (BSCCR) and
3. Computer Modeling Report (CMR).

Housing Characteristics Report

The Housing Characteristics Report documents the steps taken to establish three research sites. Each site is outside of North Carolina and in differing climate zones. The builder and research team will select 12 houses at each site to participate (each will be monitored for temperature, relative humidity, dew point, radon and gas and electric space conditioning equipment will be sub-metered for energy consumption): four with traditional wall vented crawl spaces, four with closed crawl spaces and insulation between floor joists, and four closed crawl spaces with insulation on the walls. One additional house will be built at one of the sites with a closed crawl space with both floor and wall insulation.

All research homes at each site will be built by a production builder. In addition to answering the quantitative questions about the performance of the test homes this report

also aims to document the ability of the technology to fit into a production builder's schedule. Tasks 1.1-1.7 and 2.1.-2.5 listed below describe the specific tasks reported.

Business Supply Chain Commercialization Report

In the BSCCR, researchers explore the existing marketplace for closed crawl spaces and what is needed to encourage the technology's growth in each of the three research site markets. The research team will recruit industry partners: builders, suppliers and manufacturers of products, distributors and installers of products, trainers, and local building science resources. The industry partners will sit on a Marketplace Committee to help guide the project and help insure the market will benefit. Tasks 1.1-1.3 and 4.1-4.6 listed below describe the specific tasks reported.

Computer Modeling Report

Applying the energy usage results from the HCR, the CMR compares and explores the effectiveness of a variety of popular modeling applications to predict how a closed crawl space will affect the heating and cooling load of a home. Each test house will be sub-metered for gas and electricity consumption used for space conditioning. Actual energy consumption results will be compared to the computer models predictions. In addition to tasks 3.1-3.4 this report also describes a preliminary assessment based on data from the 2005 North Carolina research project comparing a large number of energy modeling applications against each other to determine the most accurate and usable sub-set of programs which will be used to analyze the houses enrolled in the current project.

	Budget Period 1*				Budget Period 2				Budget Period 3			
	1	2	3	4	1	2	3	4	1	2	3	4
Reports & Briefs												
COR briefing												
Monthly report												
Quarterly report												
Final report												
Tasks												
1. Marketplace Performance Sites												
1.1 Form and utilize MPC												
1.2 Recruit builders												
1.3 Develop materials												
1.4 Develop protocols												
1.5 Practice installations												
1.6 Schedule construction												
1.7 Deliver homes												
2. Marketplace Performance Study												
2.1 Finalize analysis method												
2.2 Install metering												
2.3 Retrieve performance data												
2.4 Analyze results												

As a result of interviewing installers researchers understand that one of the largest challenges installers must overcome is controlling moisture in the crawl space after it has been closed and before the heating ventilation and air conditioning (HVAC) system has been activated. Several interviewees stressed the importance of proper and thorough remediation before installation, both in order for the system to function properly and to avoid liability issues post installation. Learning from the installers, the team began to research methods to control moisture issues during construction. Billy Tesh, one of the installers interviewed, introduced the team to Sostram, a company that manufactures and distributes Mold-Ram, a spray on liquid used to inhibit the growth of molds and funguses. After sufficient due diligence researchers chose Mold-Ram to incorporate into the protocols for installations that might present moisture issues during construction.

In addition to moisture issues during construction, Interviewees reiterated the need to educate code officials. From previous work the research team knew the importance of having them understand what and how a closed crawl space works. Code officials, as a general rule, are not adequately informed about closed crawl space systems. This makes them especially cautious in an attempt to avoid liability issues. In response to the interviewees continued challenge with code officials the team makes it a point to meet with the officials at each research site before construction begins. This helps to insure that the code official understands what is happening at the construction site and also give them a time to express any concerns they might have.

As for materials and tools the interviews finalized the research team's plans to use Thermax from Dow for the insulation board on the walls – Thermax is the only insulation board the research team is aware of with the appropriate fire rating required by the International Residential Code for installation in a crawl space without a thermal barrier. Researchers also added specifications in the protocol for Hilti tools used by installers to affix the liner material and insulation board to the walls. Installers through trial and error are beginning to identify the products (of those available) best suited for each job.

These examples of lessons learned clearly represent why it is so important to have the closed crawl space supply chain involved in this research. Understanding where the marketplace is and what it needs is the first step to knowing if a technology will be accepted.

As initially planned, Advanced Energy would assess the performance of the supply chain and the stakeholder's intent to become and/or remain market drivers both during and at the conclusion of the research. Additionally the costs, benefits, ability, and intent to commercialize the technology would be assessed and reported. This information, once documented can be used as a template for other markets interested in closed crawl space technology. To further disseminate the commercialization potential, journal articles would be published, conference presentations will be delivered, and summary material will be placed on the www.crawlspaces.org website.

However, as the project transitioned from funding by the DOE to the National Center for Energy Management and Building Technologies (NCEMBT) in March 2007, insufficient funding was available to continue this commercialization assessment and dissemination activity. The field study and computer modeling assessments will continue, with two of the original three field sites.

3. INTRODUCTION

The project goal is to evaluate the performance of houses constructed by industry partners, with their own funds, in three geographically dispersed locations outside of North Carolina. The project is a follow up study to a previously completed project. In 2000, the U.S. Department of Energy funded Advanced Energy to establish a 12-house research site in order to test the performance of homes with closed versus wall-vented crawl spaces in single-family, detached residential structures in eastern North Carolina. Those small (1,040 square feet), simply designed homes have been continuously monitored since 2001. The results show that the homes with closed crawl spaces have a 15-18% decrease in annual energy used for heating and cooling occupied space. This is compared to identical homes built on traditional wall-vented crawl spaces – a major reduction in energy use for the homeowner. Because this first project has been so successful, researchers want to find out how well closed crawl space technology works when house geometry is altered and geographical conditions are different. Currently, many builders and installers rely on energy modeling software applications to determine if a closed crawl space will work effectively in an area or not. From the previous research at least one modeling application was proven ineffective. Researchers will be testing multiple popular modeling software applications to document how well they predict the energy performance of homes with closed crawl spaces. In order to understand a closed crawl spaces affect on the broadest scale possible researchers must determine whether or not closed crawl space technology offers energy savings and/or moisture control in climate areas outside of eastern North Carolina's mixed humid climate and whether or not the result can be achieved in the production home builder marketplace.

In addition researchers must determine whether or not a business supply chain can be established that will for its own financial self interest grow the use of these improved construction methods in the marketplace. Building industry corporations, product manufacturers and distributors, closed crawl space installers and trainers, and others involved in the closed crawl space industry will be participating in this investigation to form a business supply chain that will be utilized as the commercialization mechanism for delivering closed crawl space construction in the production builder marketplace.

As initially planned, Advanced Energy would assess the performance of the supply chain and the stakeholder's intent to become and/or remain market drivers both during and at the conclusion of the research. Additionally the costs, benefits, ability, and intent to commercialize the technology would be assessed and reported. This information, once documented can be used as a template for other markets interested in closed crawl space

technology. To further disseminate the commercialization potential, journal articles would be published, conference presentations will be delivered, and summary material will be placed on the www.crawlspaces.org website.

However, as the project transitioned from funding by the DOE to the National Center for Energy Management and Building Technologies (NCEMBT) in March 2007, insufficient funding was available to continue this commercialization assessment and dissemination activity. The field study and computer modeling assessments will continue, with two of the original three field sites.

4. EXPERIMENTAL DESIGN

4.1 Research Description

This investigation began to examine the ability of a business supply chain, organized and embedded in the national production home builder marketplace, to deliver closed crawl space construction that actually provides the expected space conditioning energy savings. Representatives (Champions) from each of the business supply chain companies involved to create the research sites formed an advisory committee to help researchers understand current market conditions and also what is needed to commercialize the technology.

Every new technology, in order to have an impact on the marketplace must bridge a gap between early adopters of that technology and main stream acceptance. The researchers have seen this process begin for the closed crawl space supply chain in North Carolina and are expecting the Committee and subsequent evaluation of each of the individual supply chains and markets involved in the Project to impact the broader national marketplace.

The Committee will be helping to influence the Project as well as the existing marketplace so it is important that partners be drawn from every aspect of the closed crawl space supply chain. Partners recruited include:

- Production Home Builders and their sub-contractors
- Manufacturers and Distributors of Closed Crawl Space Materials
- Closed Crawl Space Installers
- Local Building Science Resources

Those partners with a large interest in the project were strongly encouraged to elect a Champion to serve on the Committee. Others, with smaller interests in the project are offered a seat on the committee if they would like to join.

4.2 Role of Advisory Committee

The Committee is made up of representatives from Advanced Energy and the participating industry partners. These partners will help to deliver the 12 research homes at each location with in-kind contributions of their goods and/or services. They will

hopefully also comprise an integrated business supply chain that after this Project can deliver closed crawl space construction to the marketplace. The Committee will also help guide the project over its duration and will help ensure that marketplace value is being delivered to stakeholders and that the investigation continues to overcome marketplace and construction barriers as they arise. It is the intention of the research team that the Committee be able to support a collaborative investigation of closed crawl space performance and delivery that significantly represents a public/private partnership and provides benefits to residential construction industry corporations and homeowners.

Influencing the Market

Project researchers believe that by identifying and bringing together an existing supply chain, that we can create dialogue and cooperation that can more quickly encourage a market to accept a technology. Researchers will be documenting the existing supply chain and commenting on its effectiveness or how it might be improved.

Influencing the Project

In addition to influencing the market the Committee will be asked to influence the Project. Researchers will maintain regular channels of discussion with the advisory committee to help ensure that the designs implemented and evaluated have a high likelihood of future market acceptance. Oftentimes, Committee members will have a more comprehensive understanding of the appropriate closed crawl space construction techniques for a market, and researchers want to make full use of this expertise.

5. PROCEDURES AND METHODS

5.1 Market Development

Sections 5, 6, and 7 will discuss the assessment of the project partners' efforts to pursue, with other members of the business supply chain, the growth of market share and establishment of new markets for closed crawl space foundations. To begin understanding what issues to address and questions to ask, researchers started out by interviewing members of the growing closed crawl space marketplace in North Carolina. They also identified what the Committee was meant to do and who should be invited to participate on the Committee.

Interviews

At the start of the Project researchers were aware that they knew a significant amount of technical information when it came to installing a closed crawl space, but were lacking the related business and market knowledge. In order to have a more complete understanding of what business lessons have been learned and challenges are still faced, researchers began to interview closed crawl space system installers across North Carolina (question in 9.1 and 9.2). Interviews were completed both on the phone and in person. In person interviews included on-site inspections of installations. After completing the interviews researchers had gained a more complete understanding of the closed crawl space market in North Carolina as well as challenges presented during an actual installation (see section 6.1).

Committee

Every partner recruited to aid in the project is offered a seat on the Marketplace Performance Committee (the Committee). Though every partner is offered a place on the Committee, those with a large stake in the Project are strongly encouraged to nominate a Champion from their company to work with the research team and other members of the Committee. Meetings of the Committee take place periodically during the entirety of the Project. They are either held via conference call or in person. Partners are necessary to the Project because they will supply needed materials and labor. They will also be the market force that would expand this technology throughout the whole marketplace. Researchers will be documenting the existing supply chain and commenting on its effectiveness.

The Committee, once formally configured, will meet as needed via conference call and/or face to face meetings to discuss the progress of the project and the future of the closed crawl space marketplace.

5.2 Partner Recruitment

Suppliers of component materials, installation tools, trainers, and those individuals involved in residential construction, material production, material distribution and installation are represented among the partner list. Certain partners may be unnecessary at a specific site, depending on its requirements, or the same partner may be involved at multiple locations. Material supplier partners depend on what materials will be used at the site.

In the sections below is listed information about the different categories of partners and who to this point has committed to participation. Please note that each potential partner is listed with a Status rating meaning:

▼	The Partner has signed a Memorandum of Understanding and is committed to working with the Project and Committee
●	The research team is currently in negotiations with the Partner and has received a verbal commitment
□	The research team was unable to work with this potential Partner

Residential Production Home Builders
Summary of Recruitment Contacts

Status	Builder	Location	Comments
▼	Empire Communities	Flagstaff, AZ	Justin Erickson from E3 Energy referred the team to this national production builder. They have a location in Flagstaff, AZ that is currently building to Energy Star standards and is interested in additional improvements. Jeff Kulovitz will act as Champion to the Committee.
▼	36 Builders	Greenwood, Delaware	Rob Lisle the owner contacted Advanced Energy to learn more about closed crawl spaces. It is a highly motivated construction company that is already building to Energy Star specifications and with closed crawl spaces. He wants to learn more about closed crawl spaces and quantify his customers' savings. 36 Builders committed to the project but subsequently was removed from the project due to changes in construction specifications and inadequate project funding after the transition to funding by the NCEMBT in March 2007.
▼	Habitat for Humanity of Greater Baton Rouge with Audubon General Contractors and Palm Harbor Homes	Baton Rouge, Louisiana and Addison, TX	George James at the Department Of Energy and Dr. Subrato Chandra at the Florida Solar Energy Center referred Advanced Energy (AE) to Palm Harbor. Palm Harbor is a highly respected producer of modular and manufactured housing and has partnered with Habitat for Humanity of Greater Baton Rouge and the Florida Solar Energy Center to provide 15 homes to the Baton Rouge site. AE's primary contact is Mr. Bert Kessler, VP of Engineering. Bert has verbally committed to being a project partner and serving on the advisory committee.
□	Shea Homes	Washington	The research team worked extensively with Shea Homes, including multiple visits to their location, however; the team was unable to gain acceptance for the project. Site supervisors wanted to do the

			project but were unable to secure corporate commitment.
□	Joyce Homes	Colorado	The team conducted a conference call with Joyce Homes and found out that construction techniques in CO traditionally utilize a half basement, half crawl space design for construction. In addition, a below grade crawl space is installed under the basement to mitigate the effects of expansive soils. There may also be present connected crawl space areas that extend both below the conditioned space of the house and under unconditioned areas like the garage and an exposed courtyard. These are very specific designs to CO and represent significant differences from typical crawl space construction which made it undesirable to site the research here.
□	Southern Land Builders	Tennessee	This builder is currently not in the position to participate in a project such as this. However the builder initiated closed crawl space foundations, at his previous company, in 2003 following on-site consulting by Advanced Energy.
□	Turnage Construction	Florida	This company is mostly contracted for high end retrofits.
□	Beazer Homes	South Carolina	Site supervisors were interested in the project but were unable to secure corporate commitment.
□	Lennar Homes	East Coast	Site supervisors were interested in the project but were unable to secure corporate commitment.
□	James Custom Homes	South Carolina	Team members spoke with Steve Malcolm from the company. They build high end tract homes with custom features and are currently doing closed crawl spaces. They will be contacted if a replacement builder is needed or there are future research opportunities.
□	Gentry Homes	Indiana	Gentry Homes is currently installing closed crawl spaces and were unwilling to participate in this project due to concern

			about risk of damage in the control homes that would have to remain vented for 12 months.
□	ChapCo Residential Builder Inc.	Virginia	The team was referred to this company by Southface Energy Institute and spoke with the owners of the company. Though they are doing energy efficient construction, they are not ready for closed crawl spaces.
□	Cunnane Group	South Carolina	They build approximately 120 homes per year to Energy Star standards and are planning to install closed crawl spaces in ongoing construction projects, but the builder was unwilling to commit the extra time to participate in the research project and was concerned about risk of damage in the control homes that would have to remain vented for 12 months.

Closed Crawl Space Installer

The research team realized that after builders the next most challenging partner to identify and recruit would be the closed crawl space installer(s) for each location.

Status	Company	Product	Comments
▼	Pest Management Systems Inc. (PMI)	Pest Control and Closed Crawl Space Installation Company	Billy Tesh, the president of PMI acts as the company's Champion to the Committee as well as the Project's installation trainer. PMI is a well respected pest control company with professional connections throughout the United States. As installation trainer, Billy works with the research team to develop protocols for installations at each location as well as to train local installers at field sites (when available) to ensure proper installations and consistency.
▼	E3 Energy	A Building Science Company	Justin Erickson, the owner of E3 Energy, will act as Champion to the Committee. E3 Energy is a building science company in Flagstaff, AZ that works closely with production builders to guarantee them for the Energy Star program.

□	Hurlock Building Products	Insulation and Closed Crawl Space Installation Company	Brian Hurlock is an insulation contractor and closed crawl space installer, operating out of Greenwood Delaware. Greenwood is in southern Delaware located between Dover and Salisbury MD. The Greenwood site was removed from the project.
□	All Pro Pest Control	Pest Control Company	Randy Bishop is a pest management professional with experience installing closed crawl spaces in Charleston, SC.
□	John Diem	Weatherization Contractor	John installs closed crawl spaces in Missoula, MT and expressed interest in participating in the MPCS study. Because the MPCS project already has a partner in a cold climate (Flagstaff, AZ) the team will partner with John.
□	AB3 Energy	Closed Crawl Space Installation Company	Allison Bailes is an installer of closed crawl spaces Carrollton, GA. The MPCS team contacted him but he is relocating and changing businesses so will be unable to participate in the project.

Manufacturers and Distributors of Closed Crawl Space Materials

At present a closed crawl space installation requires many materials. Due to the nature of the project and the need to involve all those involved with the business supply chain each product manufacturer and distributor is recruited to join the Project.

Status	Company	Product	Comments
▼	Dow Chemical Corporation	Thermax insulation board	Dow manufactures Thermax insulation board Froth-Pack insulation materials. Dow is donating both Thermax and Froth-Pack insulation to the Project. Jeff Alcott will act as Champion to the Committee.
▼	CrawlSpace Care Technologies	Liner, air control and adhesive distributor	CSCT is a sister company of PMI, providing distribution of all materials needed to install a closed crawl space system. They were instrumental in ensuring delivery of necessary materials to both research sites.

▼	Raven Industries	Liner manufacturer	Raven Industries manufactures a variety of ground vapor retarder products suitable for use in closed crawl space systems. Raven donated liner materials for use at the Baton Rouge site.
▼	Hilti	Material fastening systems	Hilti manufactures a wide variety of tools for the commercial and residential construction industries. They committed to supply fasteners for liner and insulation materials in the closed crawl space systems for the project. They have two specific nailing tools that they would like to grow the market for in the crawl space installation industry. Michael Xander will act as Champion to the Committee.
▼	Sostram	Mold-Ram	Sostram manufactures and distributes Mold-Ram, an antifungal that may be used in the crawl spaces during construction. Mold-Ram may make it easier to install closed crawl spaces by reducing the amount of moisture management needed during construction to control mold growth prior to completion. Tim Zech will act as Champion to the Committee. The project did not end up utilizing Mold-Ram at any of the project sites.
N/A	Roofing Supply Group	Phoenix, AZ	Roofing Supply Group is a distributor of Thermax insulation board. They supplied the first delivery to the research site in Flagstaff, AZ.
□	Reef Industries	Polyethylene Liner Material	Reef Industries manufactures liner material. We were unable to secure a commitment of material donation for any of the project research sites.
●	Therma-Stor	Dehumidifiers	Therma-Stor manufactures dehumidifiers and has confirmed interest in participating in Stakeholder Committee. The project has not used dehumidifiers at any of the research sites.

●	American Aldes	HVAC Supplies	American Aldes manufactures and distributes HVAC supplies, specifically for ventilation. Conversations with them indicate that they are interested in supplying the Constant Airflow Regulators and Backflow dampers for the closed crawl spaces in the study.
●	SmartVent	Closed vent that opens to allow flood waters through	Buddy Holliday is a closed crawl space installer and distributor of the SmartVent, a FEMA approved flood vent that he has been using successfully in closed crawl space installations. The team invited Buddy to participate on the Committee and he has agreed. None of the project sites required flood vents be installed.
●	Indoor Environmental Systems	Closed crawl space installer and Manufacturer of a fresh air intake system	Steve McLeod, the owner of Indoor Environmental Systems, has developed and distributes a fresh air intake system that can be used in closed crawl spaces supplying fresh air from the HVAC system as a drying mechanism. The team plans to implement this system at the Baton Rouge, LA site.
□	Nomaco	Building Products Manufacturer	Nomaco is a building products manufacturing corporation. They were committed to providing materials and technical support for the installation of several of the closed crawl space systems. Nomaco was planning to bring to market for this research investigation a building gasket with advanced properties and benefits that will be a second generation material for closed crawl space systems. During the start up period of the Project corporate management changed at Nomaco they changed their market focus and withdrew from the project.

□	Behr Processes	Coatings	Behr is a building products manufacturing corporation. They were committed to providing materials and technical support for the installation of several of the closed crawl space systems. Behr Processes was planning to bring to market for this research investigation a ground vapor barrier with advanced properties and benefits that will be a second generation material for closed crawl space systems. Behr determined that they did not have a marketable material for this initiative and that developmental costs would outweigh the potential market profit.
□	MASCO Contractor Services	National	Justin Jones, the southeast sales representative for the Environments for Living Program, a residential guaranteed performance program run by MASCO-CS met with the research team to discuss builder recruitment. Justin was instrumental in Centex, Colorado division changing their construction practice to include conditioned crawl spaces. Justin provided leads and an introduction to two Lennar representatives.

Local Building Science Resources

Though not required for any research site, having a local building science resource aids the research team. A local building science resource is able to assist with inspections and quality assurance as well as to be a local resource available to the builder, installer, and homeowner. The research team utilized its network of building science contacts to help recruit builders.

Status	Company	Location	Comments
▼	E3 Energy	A Building Science Company	Justin Erickson, the owner of E3 Energy, will act as Champion to the Committee. E3 Energy is a building science company in Flagstaff, AZ that works closely with production builders to guarantee them for the Energy Star program.

•	Florida Solar Energy Center	Florida	The MPCs team contacted Dr. Chandra (Project Director for Building America's Industrialized Housing Partnership) to solicit a manufactured housing partner. Dr. Chandra provided the team with a contact for Palm Harbor, and FSEC has subsequently provided extensive technical support to the Baton Rouge site.
□	Environmental Building Solutions	South Carolina	Scott Spivak of EBS is based in Charlotte, NC but is working with a builder in SC who plans to start construction of an Energy Star development in late summer 2006. Homes in this development are currently planned to be built with closed crawl spaces. Scott will introduce the MPCs project to the builder and connect the MPCs team with the builder.
□	Southface Energy Institute	Atlanta, GA	Sydney Roberts and Mike Barcik, employees of Southface, have worked with the team to identify builders from Southface's Earth Craft House Program as well as those joining their Building America program for recruitment into the Project.
□	Energy Services Group	Delaware	Stewart Prothero is an employee of Energy Services Group and works directly with 36 Builders to qualify them for Energy Star. Stewart is also working with the team to learn more about closed crawl space construction.
□	Mark Weatherford	Florence, SC	Mark is a HVAC contractor and helped the team with recruitment in SC.
□	Joe Kuonen	Sherwood, AR	Joe is a mechanical and home performance contractor and long-time contact of AE and is recruiting builders in the Little Rock, AR area to participate in the project.
□	Henry DeLima	N/A	Researches spoke with Henry about collaboration but it was deemed not feasible due to his work being exclusive to HUD-Code manufactured housing.

Others contacted for recruitment to Committee or to aid in partner recruitment

Some companies and individuals were contacted because they would be able to help the research team recruit business supply chain partners or because they themselves represented a stakeholder who should be represented on the Committee.

Status	Company	Location	Comments
▼	Trotter Company	Atlanta, GA	Mike Trotter owns a waterproofing company and sits on the board of trustees for the National Association of Waterproofing and Foundation Repair Contractors. Mike has agreed to be a member of the Committee.
▼	National Pest Management Association	National	Greg Baumann agreed to be on the Committee and he recommended a potential contact in Forth Worth, TX, Danny Myers of Myers Pest and Termite Services.
□	Dodson Pest Control	Raleigh, NC	Dodson Pest Control is a Raleigh-area company with offices in OH, WV, and VA. Researchers met with them to identify potential market for builder recruitment.

Conferences attended for recruitment purposes

In the building science and construction marketplace certain conferences can be counted on to attract many possible recruits.

Status	Conference	Location	Comments
N/A	National Assn. of Waterproofing and Foundation Repair Contractors	San Antonio, TX	Cyrus Dastur presented a seminar at the annual conference on July 20th to generate additional leads for final research site. A company called Sealing Agents, based in NC but installing closed crawl spaces in SC, has contacted Cyrus, received background information on the project, and is attempted to recruit builder partners for a site in SC.
N/A	Affordable Comfort	Austin, TX	Cyrus Dastur presented a seminar on the final results of the first project and the planned set up for the new project. He also met with Joe Kuonen.
N/A	Energy Efficient Building Association	Denver, CO	The research team attended this conference to meet with representatives of MASCO Contractor Services. They also used this opportunity to identify new products and builders that may be beneficial to the Project.

6. RESULTS

6.1 Summary of Interviews with North Carolina Closed Crawl Space Installers

Researchers want to understand as much as possible about the existing closed crawl space marketplace. North Carolina, due to its rapidly growing closed crawl space industry, is a good place to start. A series of questions were developed to be used both in phone interviews and on-site interviews of closed crawl space installers. The intention of these interviews was to gather information about problems installers encountered with installations, how they managed to get around these issues, where they saw the market heading, and what would help them be more successful in the market. See Summary of Interviews below.

In the summer and fall of 2005, nine closed crawl space installers who seem to be highly involved in the closed crawl space market were interviewed about their experiences with closed crawl spaces in North Carolina. Some of these individuals have been installing closed crawl space systems for up to fifteen years. The interviewers asked questions about the construction of closed crawl spaces, relationships with other interested parties, problems they've encountered in their work, and ideas for further exploration. Interviews were completed both over the phone and through site visit interviews. Please find attached a copy of the interview questions for both the phone and the on-site interviews.

All of the interviewees felt that closed crawl space systems, when properly installed, were an improvement over traditional systems. They noted problems in homes with ventilated crawl spaces such as cupping of hardwood floors, mold in air ducts, and moisture and mold problems in crawl spaces. They found that properly closed crawl space systems deterred the development of these issues.

Several installers mentioned that there is demand from homeowners and home builders for installing closed crawl spaces, both in new construction and for retrofitting existing homes. They enumerated several possible reasons for this interest. Builders are interested in reducing liability by installing systems that will make crawl spaces in the homes they construct less prone to mold development. Homeowners are increasingly concerned about mold, and upon hearing that there is a new strategy to reduce mold and fungal growth, are interested in exploring this technology. Some inquire because of interest in increasing energy efficiency, lowering indoor humidity, or reducing invasion of pests. Some homeowners also feel that the inclusion of a closed crawl space also increases their home's resale value. Several respondents noted that closed crawl spaces have a certain aesthetic appeal; they "look better" and appear "cleaner" than traditional wall ventilated systems.

One respondent, however, felt that there was a possibility of overselling the system. Most noted that the cost of closed crawl spaces could be prohibitive for average homeowners. This interviewee pointed out that the goal of this construction was simply to create a crawl space that was reliably dry, and that this might be achieved by methods besides closing it off. He suggested finding and advocating a middle ground between

traditional ventilated crawl spaces and closed crawl spaces. This could provide a system with some of the most important benefits of the closed crawl space system at a more affordable price. Others noted that closed crawl space systems, due to their complex nature, require careful quality control and periodic maintenance to ensure performance at high levels.

6.1.1 Interviews with NC Closed Crawl Space Installers – Installation Methods

The respondents were asked several questions about the procedures they developed and followed in installing closed crawl spaces. Methods were fairly consistent among the installers surveyed.

Dehumidification

The majority use dehumidifiers to temporarily dry down crawl spaces and control moisture levels. Interviewees explained that many builders will forgo installing vents in a foundation if they know the crawl space is going to be closed later. This helps the builder save money but presents a logistical problem for the installer. Installers who would not typically rely on a dehumidifier are forced to make sure one is functioning in the crawl space until the HVAC system is installed and supply air can be introduced into the crawl space. For the retrofit market, installers sometimes choose to use a dehumidifier by itself to control moisture in the crawl space after it is closed. They also explained that even if they plan on introducing conditioned air to the crawl space as the drying mechanism a dehumidifier sometimes must be used to dry out the crawl space enough to work in it.

In most areas it is important to have some form of permanent drying mechanism for the closed crawl space. For both the retrofit and new construction markets, installers most often choose to rely on conditioned air being introduced from the air handler as the drying mechanism. Some installers choose to introduce conditioned air directly from the house instead of the HVAC system. For this method a standard HVAC supply grill and flow boot is placed in the floor between the conditioned area and the crawl space. To this boot is attached flex duct and then an inline fan is attached to the flex duct. The fan draws dry air from the house and blows it into the crawl space. One interviewee explained that he has used this method when there were no ducts located in the crawl space (therefore conditioned air could not be introduced from the HVAC system) and they did not want to install a dehumidifier.

Protocols

Protocols for checking sites before and after installation varied from installer to installer. For both new construction and retrofit jobs an installer's checklist generally includes:

Water management for foundation

Interviewees said that they look for appropriate foundation drainage. This includes making sure the crawl space floor is properly graded, and ensuring that the gutters are installed correctly and draining appropriately. If necessary, a sump pump or foundation "French" drain is installed. They reported that they

monitor humidity, temperature and dew points, and some offer service plans to check the system post-installation.

Plumbing and electrical

All interviewees stated that they have protocols in place for ensuring that there are no plumbing leaks and that electrical work in the crawl is safely installed. They also check the general working condition of mechanical equipment. This sometimes involves making a note of the equipment's location so that plans can be made to upgrade/fix the equipment (if necessary) and for laying the polyethylene under it.

Employee protection

Each installer remarked that they had a specific set of guidelines to ensure the safety of their employees. These guidelines include requiring employees to wear personal protection equipment (e.g., respirators and eye protection). Some installers mentioned that they use a high powered fan to pull air out of the crawl space, creating a negative pressure inside the crawl space relative to outside. When removing old insulation or other damaged or contaminated materials this helps to minimize particulates in the crawl making it safer for the installer, but it also reduces the particulates that are able to enter the house, helping to protect the homeowner as well.

General observations

All installers interviewed remarked that they use some form of pre-installation checklist. This pre-installation checklist varies in formality but generally includes items like the following:

- Measurements of structure and perimeter
- Size/type of HVAC system
- Conditions of floor and insulation
- Wood moisture and relative humidity readings
- Evidence of flooding
- Liability assessments with homeowner
- Identifying moisture management problems and air leaks
- Soil condition, type, and presence of ground vapor retarder
- Testing for radon if needed.

Most interviewees said they usually did not vary protocol, procedure, or products unless there was a special problem or new technology became available. A few said they tailored protocols to the needs of each homeowner and home.

6.1.2 Interviews with NC Closed Crawl Space Installers – Potential Problems

The interviewees reported a host of common problems in installing closed crawl space systems. Most of these problems were not related to the actual physical installation of systems; rather, they concerned misunderstandings with other people involved in the

building process. Respondents stressed the need for education, especially for code officials and other subcontractors, to help abate some of the difficulties they faced in the installation process.

Code officials

Code officials, as a general rule, are not adequately informed about closed crawl space systems. This makes them especially cautious in an attempt to avoid liability issues. The standards for meeting code are unclear to the installer and the code official. For certain kinds of construction meeting code is especially difficult. This costs the installer time and money. Some code officials have required stamped design documents from licensed professional engineers before they would allow the crawl space to pass inspection. Other respondents said they have had to be aggressive with code officials, filing complaints and threatening to encourage the homeowners to write complaint letters after mold develops in their wall-vented crawl space.

One interviewee reported attempting to avoid code inspection by quietly assuming inspections are unnecessary for retrofits and repair. Others said they try to avoid or minimize problems by flooding inspectors with written information, giving them updated code language, specification sheets, and brochures, or writing explanatory letters for code officials to educate them about the technology and the installation process.

Yet most installers seemed quite hopeful that recent code changes in North Carolina would positively benefit their businesses, and make the process simpler and more efficient. Some reported that dealing with code officials had already become less of a headache, as the officials had a better sense of the required elements in an acceptable closed crawl space. A couple have even developed positive and productive relationships with code officials—one said he liked to refer potential customers to “closed-crawl-space-friendly” inspectors to discuss the merits of the system.

Pest Control

Problems with pest control are much like problems with code officials. There were many complaints of pest control operators and inspectors knowing little about the technology. One interviewee suggested changing from the traditional methods of spraying poison in the crawl space to monitoring station systems for pest control that would not require entry into the crawl space and could use less toxic chemicals. Another pointed out that some pest control services offer “crawl space repair” and hard-sell consumers into purchasing these programs (even if unnecessary); this puts them in competition with the closed crawl space installer.

An increasing number of pest control operators install closed crawl space systems. Those installers who are not pest control operators are able to avoid conflicts by meeting the pest control operator’s needs: creating view strips to aid detection of termite activity, putting up clear liner materials on the walls, and offering to the pest control operator to fix whatever components of the closed crawl have to be destroyed if the home requires re-treatment for an infestation.

Here again, things seem to be improving with time, although the respondents overwhelmingly felt that the overall situation could still be improved by more education. As with the code officials, some installers have found that establishing personal relationships with pest control operators is beneficial in minimizing conflict. Two respondents noted that pest control operators have begun referring homeowners with moisture management problems in their crawl spaces to them.

Other trade subcontractors

While some physical problems within the crawl space were attributed to damage from pest control, the majority were attributed to the work of other trade subcontractors, either doing shoddy work or destroying the work the installers did in the crawl space. Interviewees reported finding plumbing leaks and damaged insulation that needed repair, as well as leftover trash and debris from other contractors' work.

Other CCS installers

The few who reported problems with other CCS installers reported problems that one interviewee described as the result of a sort of professional "machismo". Installers, confident in their knowledge, can be inconsistent and lax about documentation and procedure, letting small problems slide if they are not found by inspectors, and blaming problems that are found in the crawl space on others. This may lead to future problems that require remediation.

Homeowners

Problems with homeowners were particularly problems of education. Homeowners often request these systems because they are interested in reducing mold (possibly overly concerned). Several respondents bemoaned the fact that homeowners seemed to either know very little about closed crawl spaces, or had done excessive research and still did not understand it. In either case, the installers found they had to spend time educating the homeowner about the system and how it is installed, as well as how it works. One mentioned that he wished homeowners were less willing to believe the claims of contractors who had obvious financial interests in the building process and were more willing to have third parties come in to evaluate and perform services.

Other

The complexity of closed crawl space systems contributes to some common pitfalls during installation. Systems involving multiple components require a thorough quality control process from the outset, and may also require routine maintenance to keep working at optimum levels. Hidden tasks and requirements add to the cost of the system and cause delays in construction. Problems should be identified and addressed as early as possible to minimize damage and remediation costs. Several interviewees reported that the cost of installing closed crawl spaces was still a barrier for homeowners as well as for the installers themselves, as the systems are complex and products are expensive. One respondent pointed out that the complexity and variability of the system installation process made it very difficult to quote a reliable and reasonable fixed price to consumers up front, and warned against the temptation to engage in "bidding wars" with other contractors.

The presence of preexisting mold or fungi in the crawl space and the need to remediate before installation was also a difficulty. Several interviewees stressed the importance of proper and thorough remediation before installation, both in order for the system to function properly and to avoid liability issues post installation. The need to remove all water from the crawl space was also mentioned several times as a common issue.

There were also concerns about equipment—physical size, heating and cooling capacity, combustion safety, and the need to put plastic underneath equipment already placed on the earth floor. Employees working on site must also be well protected from a host of dangers, including mold, fungus, snakes, and pests.

6.1.3 Interviews with NC Closed Crawl Space Installers - Additional Ideas

The interviewees made many suggestions about how Advanced Energy can better assist their efforts to introduce closed crawl space technology to the public. They all seemed to feel that more widespread recognition of the benefits and value of closed crawl spaces would help; many of the problems they encountered involved homeowners, installers, pest inspectors, and code officials with little understanding of the system. Several applauded Advanced Energy's current efforts to educate builders, homeowners, and others involved in the homebuilding industry, and encouraged the company to continue these efforts, perhaps by doing workshops for these populations (especially for code officials). One suggested that AE collaborate with other local building science companies to help spread the word. Another proposed establishing an interactive website or message board where builders and installers can exchange experiences and information.

They also wanted to see more written documentation of procedures and benefits. One builder suggested the establishment of a standard protocol for properly crawl spaces, citing difficulties with other builders performing improper installations and expressing a concern that frequent improper installations could be counterproductive for the industry. This protocol could be written and distributed to installers. One put forth the idea of a certification program for installers, assuring homeowners that their installer is qualified. Others suggested checklists to educate code inspectors; one specified that a list of terms and codes that inspectors could use as a reference tool when inspecting these systems would be useful in avoiding unnecessary citations.

In order to keep accurate information distributed on all sides, the interviewees suggested interventions with homeowners to help them understand the closed crawl space installation process. One builder suggested literature that could be distributed to homeowners would be helpful; another thought that Advanced Energy should be more involved with homebuilders associations.

For the future, one of the builders felt the company should not lose sight of the relative importance of closed crawl spaces. This builder, while an advocate of the closed crawl space system, thought the industry should continue researching the system to measure

long-term effectiveness. This interviewee also felt strongly that the industry should do research to figure out the best way to keep ventilated systems dry, and present that research so that people could make more informed choices.

6.2 Partner Recruitment

Advanced Energy has spent many years working successfully with large production builders and felt that its contacts with these builders would generate good recruits for this research partnership. However, as recruitment efforts went on it became clear that the company's connections with these builders were insufficient to secure participation in the Project. One reason for this difficulty in recruiting is that most of the production builders Advanced Energy works with are such large companies that making the correct contact and acquiring permission for participation in a research activity is a process that takes more time than allowed by the Project's timeline. The larger corporate bureaucracies also proved to be more concerned about the risks of failing in the project and their inability to implement change in their large-scale processes. As a result, researchers shifted our recruitment efforts to utilize our national network of building science and other professional contacts to identify smaller, more nimble production builders who were actively interested in implementing and testing closed crawl spaces. In addition, we utilized several conference presentations as opportunities to recruit builder partners and we discussed the project in independent training activities with builders and contractors to make them aware of the partnership opportunity.

In addition to recruiting builder partners, part of the project plan involved recruiting a closed crawl space installation partner. We anticipated that not every market where we found a builder partner would have an existing installer of closed crawl spaces we could utilize. Therefore we needed a partner to do installations or to provide training services so the builder partner or other local company could serve as the local installer.

Originally the team planned to work with Masco as the installation partner. Masco is a multi-billion dollar national company that installs insulation and many other materials and subsystems for production home builders in the United States. However, Masco decided not to participate in the project. Researchers subsequently approached Pest Management Systems, Inc. (PMI), a Greensboro, NC based pest management company. PMI's owner, Billy Tesh, has led the development of PestOne, "a network of Independent Pest Management Companies dedicated to providing 'State of the Art' pest control while being non-disruptive to the environment or to the clients they serve" (PestOne, 2006). Several years ago PMI added closed crawl spaces to the list of services the company offers. PMI also offers training to other companies (including those in PestOne) on how to properly install a closed crawl space. Billy has worked extensively with Advanced Energy previous to this Project to resolve pest control industry concerns regarding crawl spaces, to write new code language related to crawl spaces for use in NC, and to help improve quality and consistency of installations from site to site. PMI agreed to serve as the project installation partner, providing installation services or on-site training as needed at each research site.

Flagstaff, AZ Site

The research team's first introduction to the possibility of having a research site in Flagstaff, AZ came after a recruitment call to Justin Erickson of E3 Energy, located in Flagstaff, AZ. Justin has worked with Advanced Energy on other projects and currently works with builders to qualify them for the Energy Star home performance programs. Justin pitched the research idea to staff at Empire Communities and subsequently introduced them to the research team. After initial conversations team members were able to visit the site and discuss specific designs with representatives of the builder and E3. Both the builder and E3 have nominated a Champion to sit on the Committee. In addition Billy Tesh of PMI agreed and has completed closed crawl space installation training for employees of E3 Energy. During a subsequent visit, representatives of AE and all the local partners presented the research plan to representatives of the Flagstaff permitting and code enforcement offices for approval.

Partners for the Flagstaff site include:

- Production Home Builders
 - ▼ Empire Communities
 - ▼ Subs in Flagstaff
- Closed Crawl Space Installers and Trainers
 - ▼ PMI
 - ▼ E3 Energy
- Local Building Science Resources
 - ▼ E3 Energy
- Manufacturers and Distributors of Closed Crawl Space Materials
 - ▼ Dow Chemical
 - ▼ CSCT
 - ▼ Hilti Products Corp

Baton Rouge, LA

George James at the Department of Energy and Dr. Subrato Chandra at the Florida Solar Energy Center (FSEC) referred Advanced Energy (AE) to Palm Harbor. Palm Harbor is a highly respected producer of modular and manufactured housing.

Habitat for Humanity of Greater Baton Rouge approached FSEC to help them develop the most appropriate minimum construction standards for the region. Palm Harbor is a Building America member and will be working with FSEC and Habitat for Humanity of Greater Baton Rouge to

Partners for the Baton Rouge site include:

- Production Home Builders
 - ▼ Palm Harbor
 - ▼ Habitat For Humanity of Greater Baton Rouge
- Closed Crawl Space Installers and Trainers
 - ▼ PMI
- Local Building Science Resources
 - ▼ Florida Solar Energy Center
- Manufacturers and Distributors of Closed Crawl Space Materials
 - ▼ Dow Chemical
 - ▼ Raven Industries
 - ▼ Hilti Products Corp

build the development that will serve as the pilot for the new standards. The closed crawl space specifications used in this pilot, if proven effective, may become part of the new standards.

Advanced Energy's primary contact at Palm Harbor is Mr. Bert Kessler, VP of Engineering. Bert has verbally committed to being a project partner and serving on the advisory committee.

Palm Harbor has finished construction on all 15 homes and the research team has acquired homeowner agreements from the participants. The team has also identified local sub-contractors to install electric sub-meters, as well as a local building performance specialist to perform energy testing.

Greenwood, DE

In early 2006 Advanced Energy staff conducted a building science training course in Phoenix, AZ. One of the attendees was Brian Hurlock of Hurlock Building Products. Brian works with a construction company called 36 Builders in Greenwood, DE who has started to build homes with closed crawl spaces. When the trainers from Advanced Energy mentioned the Project and how the team was currently looking for partners he was immediately interested. Rob Lisle, the owner of 36 Builders, subsequently contacted Advanced Energy and expressed an interest in becoming a research partner. On September 6, 2006 the research team met with Rob and Brian in Greenwood, DE to discuss the details of the Project and to tour several homes currently under construction. Rob signed a memorandum of understanding to participate in the Project and introduced the team to Stewart Prothero, an employee of Energy Services Group, a local building performance contracting company. 36 Builders contracts with Energy Services Group to qualify their houses for Energy Star certification.

36 Builders began construction of five homes for the Project; however, conversations leading up to and during a February 2007 visit indicated that the builder was significantly behind the schedule needed for participation in the project and desired to significantly change their construction designs. Due to both the change in construction details and the lack of funding available under the NCEMBT this partner is no longer participating in the project.

7. FINDINGS

The NC closed crawl space installer interviews provided helpful insight for the Project. Because of these interviews researchers decided to engage Sostram as a project partner and to provide Mold-Ram to test homes in order to control moisture issues that may present during construction. Each of the builders has chosen to keep Mold-Ram as an option for future use but to exclude it from the initial process. As well, researchers understand the importance of including code officials at the beginning of establishing a research site to ensure their acceptance. Representatives for the research group and builder met with each city's code officials prior to implementing closed crawl spaces for the Project. As for materials and tools the interviews finalized the research team's plans to use Thermax from Dow for the insulation board on the walls – Thermax is the only insulation board the research team is aware of with the appropriate fire rating required by the International Residential Code for installation in a crawl space without a thermal barrier. Researchers also added specifications in the protocol for the Hilti tools used by installers to affix the liner material and insulation board to the walls.

The interviews helped researchers understand challenges they might face during the Project but even with this knowledge it is still necessary to identify drivers of the market.

Many of the installers in NC told researchers, during the interviews, that one of the ways they market closed crawl spaces is to advertise them as energy savers. The previous research project in Princeville, NC showed this to be true for North Carolina's mixed-humid climate. Installers in NC use these results so it is logical then to think that the market in other areas could use the same type of information. This research project is designed to determine the magnitude of energy savings in other climates, however; while writing the Project Narrative for this Project Bruce Davis and Ewan Pritchard (an engineer working for Advanced Energy) calculated the possible energy savings of closing crawl spaces throughout the country. This calculation was based on the energy savings documented at the Princeville site and extrapolated for the entire country using the Official Method for determining National Benefits. The information in the Project Narrative follows and a more in-depth description of the process used to determine the savings is attached in the appendix (see section 10.3).

Preliminary research is indicating a 36% household cooling energy savings when using the wall insulation method. However, this method brings a 4% heating energy penalty. It is likely that this method is best for primary cooling climates where more than 70% of homes are air conditioned. This study will investigate whether or not this particular savings rate holds true in other geographic regions. If it does hold true, closing crawl spaces has a maximum potential annual savings of **99 trillion BTU**. This savings would also represent **1.6 million metric tons of carbon emissions savings**.

The second method of closing crawl spaces uses a floor insulation method. Preliminary research indicates a 22% reduction in cooling energy usage and an 10% reduction in heating energy usage. Again, this expanded research will show if these preliminary indicators will hold true in other climate zones. If this system was to be adopted nationally and the numbers hold true, there is the potential for an annual savings of **388 trillion BTU and 6.0 million metric tons of Carbon**.

Clearly, there is a large potential for energy savings and carbon emission reduction here. Even if we reach *only* the 200,000 new homes built annually using crawl space foundations we can reduce energy consumption by 14.9 million BTU per home, or 2.9 trillion BTU per year, compounded with future years' construction.

The following analyses are intended to provide the construction and research communities with a broader and deeper understanding of the existing market for closed crawl spaces and what might be done to expand and otherwise improve it. To this end, it is the goal of the researchers to understand the economic feasibility of this technology.

7.1 Flagstaff, AZ

Regional analysis

Edwin M. Larsen is a Building Official with the Project Review Section in the Development Services Division for the City of Flagstaff, Arizona. According to Edwin, approximately 50% of the 320 – 400 new homes built every year in Flagstaff are built with crawl spaces.

Traditionally crawl spaces in Flagstaff are built to the 2003 IRC. As soon as Empire Communities agreed to participate in the Project a meeting was held with representatives from the city (including Edwin Larsen), from Empire Communities, and from Advanced Energy. During this meeting the traditional vented crawl space code was discussed and the designs of the research closed crawl spaces were presented and approved.

Ideally at every site the research team will be able to identify a local building science resource. In Flagstaff, the team is working with E3 Energy, a building science company Advanced Energy has worked with in the past. Not only is E3 Energy acting as a local contact for the research partners, but E3 also expressed interest in being the installer. Billy Tesh, installation trainer, accompanied the research team on two visits to Flagstaff to train employees. For these closed crawl space installations, the wall insulation, vapor retarder and related fasteners had to be shipped to the location due to lack of local source of supply.

Supply Chain Analysis

The project advisory Committee has provided extensive input to the research team with regard to the development of installation designs and processes, trainings, and delivery of materials. The supply chain for the Flagstaff site is relatively common. The builder is responsible for procuring most of the materials needed for the construction of the houses, and is responsible for making sure they are delivered to the job site for the sub-contractors. Some of the materials like plumbing and electrical are provided by sub-contractors. This meant that Empire had the choice to work with the team to procure the materials necessary for the installations or Empire could allow the team to work with a sub-contractor. Empire decided that the research team should work with a sub-contractor so the team began working with E3 Energy as the installer.

For this site the key components to the closed crawl space installations, the polyethylene liner and the perimeter insulation board, do not have an existing supply chain. To compensate for this, project partners have created their own new supply chain to deliver materials. This new supply chain will be used during the project and can be continued after. Outside of the vapor retarder, spray foam and rigid insulation board, E3 Energy is responsible for procuring the materials for the installations. These include such things as caulk and stakes. Hilti Tools, another project partner, is providing the fasteners needed to install the vapor retarder and insulation board, and E3 Energy has invested in the tools necessary to use these fasteners.

7.2 Baton Rouge, LA

Regional Analysis

Currently in Baton Rouge, LA builders are held to the 2003 International Residential Code (IRC). In January 2007, the 2006 IRC will take effect. The region has a great need for additional housing due to damage sustained in hurricanes Katrina and Rita in 2005. Modular construction is well suited for this reconstruction effort. In this region, homes are traditionally built with raised floors on a crawl space or open pier foundation, though in recent years increasing numbers of homes have been built on slab foundations. However, since hurricane Katrina, new construction requirements and FEMA guidelines will increase the use of raised floor construction.

Supply Chain Analysis

The project advisory Committee has provided extensive input to the research team with regard to the development of installation designs and processes, trainings, and delivery of materials. The supply chain for the Baton Rouge is common for the manufactured home market but different from the typical construction market. The builder, Palm Harbor, builds the homes in their factory and then ships them and sets them on their foundations at the site. Habitat for Humanity of Greater Baton Rouge though they are the contractor and will be selling these homes to individuals after construction they have little to do with the procurement of materials or the construction of the home. Due to the fact that there was no volunteer labor to construct this Habitat site the research team and Habitat for Humanity of Greater Baton Rouge decided the Project should work with a sub-contractor to complete the closed crawl space installations.

For this site the key components to the closed crawl space installations, the polyethylene liner and the perimeter insulation board, do not have an existing supply chain. To compensate for this, project partners have created their own new supply chain to deliver materials. This new supply chain will be used during the project and can be continued after.

7.3 Greenwood, DE

Regional Analysis

As soon as 36 Builders agreed to participate in the Project a meeting was held with representatives from the city, from 36 Builders, and from Advanced Energy. During this meeting the traditional vented crawl space code was discussed and the designs of the research closed crawl spaces were presented and approved.

In Greenwood, the team was working with Stewart Prothero, a building performance specialist for Energy Services Group, out of Wilmington, DE. 36 Builders was already working with a closed crawl space installer, Hurlock Building Products (HBP). Billy Tesh, the closed crawl space installation trainer, agreed to train HBP employees on the specifics of how the closed crawl spaces needed to be completed for the Project. However, before this could happen 36 Builders withdrew from the Project due to changes in their construction schedule and lack of funding for this site in the project.

Preliminary Supply Chain Analysis

The builder at this location previously owned a collection of building products companies and recently increased its volume of construction with the goal of ensuring that their products and systems are installed in a manner that maximizes their goals of improving performance and energy efficiency. This builder already has experience with installing closed crawl spaces via their insulation company (Hurlock Building Products). Since Hurlock Building Products was already installing closed crawl spaces a procurement chain for most of the products needed already existed.

8. RECOMMENDATIONS

It is the intention of the Business Supply Chain Commercialization assessment to provide an investigation of the business supply chain's organizational ability and intent to deliver closed crawl space construction in the marketplace. The research team has successfully established agreements that secured the required research sites along with a wide range of supply chain partners that will ensure the installation of properly closed crawl spaces for this investigation. Based on the success of the BP 1 work the research team makes the following recommendations.

The beneficial business relationships established should be continued with individual Champions and within the Marketplace Committee to maintain both the financial support and business guidance to maximize the commercialization potential of closed crawl space technology.

Future funding should be approved to provide for a catalytic environment where individual members of the Marketplace Committee could transition into a unified business supply chain that would expand closed crawl space construction for their own financial gain. In addition it will provide a unique opportunity to analyze from an inside perspective business market transformation.

9. REFERENCES

References are listed in the Computer Modeling Report.

10. APPENDIX

10.1 Phone Interview Questionnaire

- 1) When/Why did you begin to pay attention to or to perform closed crawl construction?
- 2) What market are you working in – New Construction or Remodeling/retrofit (or both), and for what type of builder; production, spot, custom?
- 3) What pitfalls would you warn a new builder and/or installer to be aware of when considering performing CCS construction methods?
- 4) What types of roadblocks, if any, do you encounter now? (New Construction or Retrofit)
 - i. With building code officials
 - ii. With Pest control operators and/or inspectors
 - iii. With existing trade subcontractors
 - iv. With other CCS installer contractors
 - v. With homeowners
- 5) How do you go about determining the type of drying mechanism you will use, and if you use a dedicated run(s) off of a distribution supply trunk(s) how do you go about sizing the duct(s) and opening(s)?
(I.e.: CFM, etc)
- 6) What “protocols” and/or “pre-requisites” pertaining to CCS have you developed?
I.e.:
 - i. Pre-existing conditions noted and required to be addressed prior to you performing the installation
 - ii. Liability “checklists” (I.e.: drainage and water removal equipment, HVAC equipment, access limitations or rules for contractors, inspectors that may need to work in finished crawl space, etc.)
 - iii. Testing or diagnostics you perform before (and after) installing CCS systems
 - iv. Staff safety issues and Best Practices methods
- 7) Do your closed crawl construction methods remain the same each time or do your procedures and practices vary based upon the condition of the crawl space, home, site, etc.? Also, do you find yourself using different materials and/or systems for different foundations; poured concrete, brick, or block matched with varying floor types, dirt, clay, or gravel?
- 8) Do you think the NC code change will make a significant difference for you?

- 9) What types of things are we at Advanced Energy doing, or could be doing, to help educate code officials, PCO's and pest inspectors?
- 10) What do you feel is needed to improve Closed Crawl Space construction – overall?
- 11) Do you find the cost to be prohibitive to many homeowners? Builders?
- 12) What materials are you currently using to perform closed crawl space construction?
- Insulation – what type and where?
 - How is material used installed?
 - Vapor barriers/retarders – what type and where?
 - How is the material used installed?
 - Drainage – Installed? If so...
 - What type is utilized
 - Dehumidification – processes, materials and equipment used?
- 13) What is your method of dealing with combustion safety? How do you ensure fresh air and how much do you require?
- 14) Do you have a contract agreement with your clients? If so what is the content of this agreement? Do you have one for the homeowner and/or the builder?
- 15) How do you manage the contractor to client relationship?
- 16) Generally, how do homeowners respond to having their crawl spaces closed?
- What benefits do they associate with CCS vs. traditional open crawls
 - Expectations? Why are they having this work done?
- 17) What is the Builder feedback? (Pros & Cons)
- What benefits do they associate with CCS vs. traditional open crawls
 - Expectations? Why are they having this work done?

10.2 Interview Questions for Site Visits

- 1) In general how do you feel about the closed crawl space industry, and do you have any specific areas of concern for the industry and where it is headed?
- 2) When/Why did you begin to pay attention to or to perform closed crawl construction?
- 3) What market are you working in – New Construction or retrofit (or both), and for what type of builder; production, spot, custom?
- 4) What were some of the original hurdles you had to overcome in order to start building/installing these systems? Within New Con &/or retrofit
- 5) What types of roadblocks do you encounter now? (New Construction or Retrofit)
- 6) What pitfalls would you warn a new builder and/or installer to be aware of when entering the field?
- 7) What literature or resource information have you referred to regarding CCS installations?
 - I.e.: Advanced Energy website, BSC website, trade magazines, etc.
- 8) What things are you finding in the field - that varies from the literature/information you've read about on closed crawl installations?
- 9) Re: New Construction – Drying mechanisms used?
 - i. Dehumidifiers:
 - ii. Duct brought in directly from house
 - iii. Dedicated run(s) off of distribution supply trunk(s) to crawl space: Uses a CAR and butterfly.
 - iv. Utilize existing duct leakage in existing distribution system running through the space
 - v. Other
- 10) How do you go about determining the type of drying mechanism you will use, and if you use a dedicated run(s) off of a distribution supply trunk(s) how do you go about sizing the opening?
 - I.e.: CFM, duct size, etc.
- 11) Re: Retrofit Construction – Drying mechanisms used?
 - i. Dehumidifiers
 - ii. Duct brought in directly from house (or outside)
 - iii. Dedicated run off of one distribution supply trunk to crawl space
 - iv. Utilize existing duct leakage (in existing distribution system) running through the space

v. Other

- 12) How do you go about determining the type of drying mechanism you will use, and if you use a dedicated run(s) off of a distribution supply trunk(s) how do you go about sizing the opening?
I.e.: CFM, duct size, etc.
- 13) What “protocols” and/or “pre-requisites” pertaining to CCS have you developed?
I.e.:
- i. Pre-existing conditions noted and/or required to be addressed prior to you performing the installation:
 - ii. Liability “checklists” (I.e.: drainage and water removal equipment, HVAC equipment, access limitations or rules for contractors, inspectors that may need to work in finished crawl space, etc.)
 - iii. Testing or diagnostics you perform before (and after) installing CCS systems: no with exception to radon if concerned. We have a guy in our company who can do a pre and post test.
 - iv. Staff safety issues and Best Practices methods
- 14) Do your closed crawl construction methods remain the same each time or do your procedures and practices vary based upon the condition of the crawl space, home, site, etc.? Also, do you find yourself using different materials and/or systems for different foundations (poured concrete, brick, or block) matched with varying floor types (dirt, clay, or gravel)?
- 15) Do you encourage others to build using closed crawl/space construction?
- 16) Have you encountered much resistance from building code officials?
- i. If so, how do you approach the officials to explain the new construction technique and its benefits?
 - ii. What code issues do you discuss? – I.e.: the new code changes...allowing this method.
 - iii. Do you provide resource materials to the inspectors – to support this construction method, to support the code changes? If so, what materials?
- 17) Do you think the NC code changes will make a significant difference for you?
- 18) Have you met a lot of resistance from Pest Control Operators and/or Pest Control inspectors? If so, how have you been addressing these issues?
- 19) What types of things are we at Advanced Energy doing, or could be doing, to help educate code officials, PCO’s and pest inspectors?
- 20) What do you feel is needed to improve Closed Crawl Space construction – overall?
- 21) Do you utilize different price structures when creating quotes for new jobs, and what do you find the breakdown of labor and material costs to be?

- 22) Do you find the cost to be prohibitive to many homeowners? Builders?
- 23) What materials are you currently using to perform closed crawl space construction?
- Insulation – what type and where?
 - How is the material used installed?
 - Vapor barriers/retarders – what type and where? Raven
 - How is the material used installed?
 - Drainage – Installed? If so...by whom?
 - What type is utilized?
 - Dehumidification – processes, materials and equipment used?
- 24) Do you procure from manufacturers directly or via distributors or at retail locations?
- Relevant to each of the materials & products used
- 25) Generally, how do homeowners respond to having their crawl spaces closed?
- What benefits do they associate with CCS vs. traditional open crawls
 - Expectations? Why are they having this work done?
- 26) What is the Builder feedback? (Pros & Cons)
- What benefits do they associate with CCS vs. traditional open crawls: reduce liability, better product, reduce callbacks?
 - Expectations? Why are they having this work done?
- 27) Do you address combustion safety? If so, How?
I.e.: testing, flagging problems/notifications, retrofitting, etc.
- 28) Do you have a contract agreement with your clients? If so, what is the general content of this agreement?
- 29) How do you manage the contractor-to-client relationship?
- 30) How do you manage moisture and mold growth during the installation/construction process?
- 31) As it relates to safeguarding against failure, i.e. your liability, when doing an installation on new construction when are you usually able to do the installation, and when do you prefer?
- a. At foundation completion (pre-framing)
 - b. Alongside the framing process
 - c. At the back-end, when construction is completed
- 32) Do you find the cost of the material prices to be prohibitive?

10.3 Official Method for Determining National Benefits

74 million homes in U.S. / 26 million with crawl spaces - Approximately 35% of homes in the US have crawl spaces. (US Census)

Closed with Wall Insulation Method

36% savings on Cooling Energy

-4% Savings on Heating Energy

With a maximum potential market penetration of 35%

Cooling Proposal

National Total Energy Savings= 0.204 quads

$36\% * 1.62 \text{ Quads (Table A – Total Space Cooling)} * 35\% = 0.204 \text{ quads}$

National Total Carbon Savings = 3.20×10^6 metric tons C

$0.204 \text{ Quads} * 15.67 \text{ kg/mmBtu (Table E – Electricity)} = 3.20 \times 10^6 \text{ metric tons C}$

Heating Proposal

National Total Energy Savings= -0.105 quads

$-4\% * 7.52 \text{ Quads (Table A – Total Space Heating)} * 35\% = -0.105 \text{ quads}$

National Total Carbon Savings = -1.61×10^6 metric tons C

$-0.105 \text{ Quads} * 15.35 \text{ kg/mmBtu (Table E – Res. Ht.)} = -1.61 \times 10^6 \text{ metric tons C}$

Total Proposal:

National Total Energy Savings= 0.099 quads

National Total Carbon Savings = 1.59×10^6 metric tons C

Closed with Floor Insulation Method

22% savings on Cooling Energy

10% Savings on Heating Energy

With a maximum potential market penetration of 35%

Cooling Proposal

National Total Energy Savings= 0.125 quads

$22\% * 1.62 \text{ Quads (Table A – Total Space Cooling)} * 35\% = 0.125 \text{ quads}$

National Total Carbon Savings = 1.95×10^6 metric tons C

$0.125 \text{ Quads} * 15.67 \text{ kg/mmBtu (Table E – Electricity)} = 1.95 \times 10^6 \text{ metric tons C}$

Heating Proposal

National Total Energy Savings= 0.263 quads

$10\% * 7.52 \text{ Quads (Table A – Total Space Heating)} * 35\% = 0.263 \text{ quads}$

National Total Carbon Savings = 4.04×10^6 metric tons C

$0.263 \text{ Quads} * 15.35 \text{ kg/mmBtu (Table E – Res. Heat)} = 4.04 \times 10^6 \text{ metric tons C}$

Total Proposal:

National Total Energy Savings= 0.388 quads

National Total Carbon Savings = 5.99×10^6 metric tons C

Computer Modeling Report

Closed Crawl Space Performance:
Proof of Concept in the Production Builder Marketplace

U.S. Department of Energy
Instrument No. DE-FC26-04NT42319

January 11, 2008

Project Directors
Bruce Davis
Melissa Malkin-Weber

Project Manager
Cyrus Dastur

Research Associates
Maria Mauceri
Benjamin Hannas
Arwen Carter

Submitted To:
Parrish Galusky, Project Manager, U.S. Dept. of Energy

Advanced Energy
909 Capability Dr. Suite 2100
Raleigh, NC 27606
www.advancedenergy.org
919-857-9000

DISCLAIMER

This report was prepared as an account of work sponsored by an agency of the United States Government. Neither the United States Government, nor any agency thereof, nor any of their employees, makes any warranty, express or implied, or assumes any legal liability or responsibility for the accuracy, completeness, or usefulness of any information, apparatus, product, or process disclosed, or represents that its use would not infringe privately owned rights. Reference herein to any specific commercial product, process, or service by trade name, trademark, manufacturer, or otherwise does not necessarily constitute or imply its endorsement, recommendation, or favoring by the United States Government or any agency thereof. The views and opinions of authors expressed herein do not necessarily state or reflect those of the United States Government or any agency thereof.

TABLE OF CONTENTS

1. Acknowledgements
2. Executive Summary
3. Introduction
4. Experimental Design
 - 4.1 Background of Selected Software
 - 4.1.1 AUDIT v.7.02.26 and RHVAC v.8.01.151 by Elite Software
 - 4.1.2 Energy-10 v.1-7 by Sustainable Buildings Industry Council
 - 4.1.3 EnergyGauge USA v.2.42 by Florida Solar Energy Center
 - 4.1.4 EnergyPlus v.1-3 by United States Department of Energy
 - 4.1.5 Micropas6 v.6.01 by Enercomp, Inc.
 - 4.1.6 REM/RATE v.12.11 by Architectural Energy Corporation
 - 4.1.7 Right-Suite Residential for Windows v.6.0.27 by Wrightsoft Corporation
 - 4.1.8 TREAT v.3.0.19 by Performance Systems Development Inc.
 - 4.1.9 VisualDOE v.4.1.2 by Architectural Energy Corporation
 - 4.2 Acceptance of Software in Modeling Community
 - 4.3 Previous Software Reviews
5. Procedures and Methods
6. Results
7. Findings
8. Recommendations
9. References
10. Appendix

1. ACKNOWLEDGEMENTS

This report was prepared with the support of the U.S. Department of Energy, under Award No. DE-FCC-04NT42319. However, any opinions, findings, conclusions, or recommendations expressed herein are those of the author(s) and do not necessarily reflect the views of the DOE.

2. EXECUTIVE SUMMARY

Advanced Energy completed its first jointly-funded crawl space research project with the Department of Energy in 2005. That project, funded under award number DE-FC26-00NT40995 and titled “A Field Study Comparison of the Energy and Moisture Performance Characteristics of Ventilated Versus Sealed Crawl Spaces in the South” demonstrated the substantial energy efficiency and moisture management benefits that result from using properly closed crawl space foundations for residential construction instead of traditional use of wall vented crawl space foundations. In an effort to further understand the energy efficiency benefit of closed crawl spaces, researchers proposed additional work to the Department of Energy. That proposal was accepted and funded under award number DE-FC26-04NT42319, titled “Closed Crawl Space Performance: Proof of Concept in the Production Builder Marketplace”. We informally refer to this current project as the Marketplace Performance Crawl Space Project (the Project). The Project is intended to explore four research questions:

- (1) Can closed crawl space technology offer energy savings and/or moisture control in climate areas outside of eastern North Carolina’s mixed humid climate?
- (2) Can this result be achieved in the production home builder marketplace?
- (3) Can a business supply chain be established that will for its own financial self interest grow the use of these improved construction methods in the marketplace?
- (4) Can popular energy modeling software applications successfully predict the energy performance of closed crawl spaces?

These research questions will be addressed in three technical reports:

1. Housing Characteristics Report (HCR),
2. Business Supply Chain Commercialization Report (BSCCR) and
3. Computer Modeling Report (CMR).

Housing Characteristics Report

The Housing Characteristics Report documents the steps taken to establish three research sites. Each site is outside of North Carolina and in differing climate zones. The builder and research team will select 12 houses at each site to participate (each will be monitored for temperature, relative humidity, dew point, radon and gas and electric space conditioning equipment will be sub-metered for energy consumption): four with traditional wall vented crawl spaces, four with closed crawl spaces and insulation between floor joists, and four closed crawl spaces with insulation on the walls. One additional house will be built at one of the sites with a closed crawl space with both floor and wall insulation.

All research homes at each site will be built by a production builder. In addition to answering the quantitative questions about the performance of the test homes this report

also aims to document the ability of the technology to fit into a production builder’s schedule. Tasks 1.1-1.7 and 2.1.-2.5 listed below describe the specific tasks reported.

Business Supply Chain Commercialization Report

In the BSCCR, researchers explore the existing marketplace for closed crawl spaces and what is needed to encourage the technology’s growth in each of the three research site markets. The research team will recruit industry partners: builders, suppliers and manufacturers of products, distributors and installers of products, trainers, and local building science resources. The industry partners will sit on a Market Place Committee to help guide the project and help insure the market will benefit. Tasks 1.1-1.3 and 4.1-4.6 listed below describe the specific tasks reported.

Computer Modeling Report

Applying the energy usage results from the HCR, the CMR compares and explores the effectiveness of a variety of popular modeling applications to predict how a closed crawl space will affect the heating and cooling load of a home. Each test house will be sub-metered for gas and electricity consumption used for space conditioning. Actual energy consumption results will be compared to the computer models predictions. In addition to tasks 3.1-3.4 this report also describes a preliminary assessment based on data from the 2005 North Carolina research project comparing a large number of energy modeling applications against each other to determine the most accurate and usable sub-set of programs which will be used to analyze the houses enrolled in the current project.

	Budget Period 1*				Budget Period 2				Budget Period 3			
	1	2	3	4	1	2	3	4	1	2	3	4
Reports & Briefs												
COR briefing												
Monthly report												
Quarterly report												
Final report												
Tasks												
1. Marketplace Performance Sites												
1.1 Form and utilize MPC												
1.2 Recruit builders												
1.3 Develop materials												
1.4 Develop protocols												
1.5 Practice installations												
1.6 Schedule construction												
1.7 Deliver homes												
2. Marketplace Performance Study												
2.1 Finalize analysis method												
2.2 Install metering												
2.3 Retrieve performance data												
2.4 Analyze results												

Since closed crawl space methods are a new concept to most production building markets, modeling applications may or may not have incorporated the energy loss and gains from the construction practices investigated in this study. By performing an analysis of modeling applications, the effectiveness of models to predict potential energy savings between different crawl space configurations can be better understood and quantified. Results from this study can be used to determine application(s) that would be best to use for a closed crawl space method, as well as provide data for use to improve the accuracy of future versions of the applications.

Through an initial investigation of available modeling applications, three have been chosen to be used in modeling the houses in the Marketplace Performance Crawl Space Project: EnergyGauge, REM/Rate, and TREAT. These applications were chosen based on the pre-screening method mentioned above.

Note that in March 2007, funding for this project was discontinued by the Department of Energy and transitioned to the National Center for Energy Management and Building Technologies (NCEMBT).

3. INTRODUCTION

This research will evaluate the performance of houses constructed by industry partners, with their own funds, in three geographically dispersed locations outside of North Carolina. The MPCs Project is a follow up study to a previously completed project, “A Field Study Comparison of the Energy and Moisture Performance Characteristics of Ventilated Versus Sealed Crawl Spaces in the South,” Department of Energy Instrument # DE-FC26-00NT40995, June 22, 2005. This previous project began in 2000 with the U.S. Department of Energy funding Advanced Energy to establish a 12-house research site in order to test the performance of homes with closed versus wall-vented crawl spaces in single-family, detached residential structures in eastern North Carolina. Those small (1,040 square feet), simply designed homes have been continuously monitored since 2001. The results show that the homes with closed crawl spaces have a 15-18% decrease in annual energy used for heating and cooling the occupied space. This is compared to identical homes built on traditional wall-vented crawl spaces—a major reduction in energy use for the homeowner. Because this first project has been so successful, researchers want to find out how well closed crawl space technology works when house geometry is altered and geographical conditions are different. A mixed-humid climate, like that of eastern North Carolina, seems to benefit greatly from closing the crawl space. This crawl space design not only tempers the area where the HVAC equipment is located, resulting in a reduction of energy use, but it also helps prevent humid air from entering the crawl space and condensing on cooler surfaces. Condensation can result in damaged mechanical equipment and compromised wood framing. However, it is still unconfirmed whether closed crawl spaces in other climates constructed in the production builder markets will see the same benefits. The purpose of this initiative is to investigate those performance questions.

4. EXPERIMENTAL DESIGN

The energy efficiency and construction industries increasingly rely on predictions produced by modeling applications to determine the energy use of a structure. Examples of this include the Home Energy Rating System (HERS) ratings, cost justifications for retrofits, International Energy Conservation Code (IECC) compliance, and United States Environmental Protection Agency (EPA) Energy Star compliance. Further information including the relationship between these entities can be found on the RESNET website (RESNET, 2006):

Home energy ratings provide a standard measurement of a home's energy efficiency. Ratings are used for both new and existing homes. In new homes ratings often verify energy performance for the ENERGY STAR homes program, energy efficient mortgages, and energy code compliance. Homeowners who want to upgrade the home's energy efficiency can use the energy rating to evaluate and pinpoint specific, cost-effective improvements. For existing homes, homeowners can receive a report listing cost-effective options for improving the home's energy rating. An energy rating allows a homebuyer to easily compare the energy performance of the homes being considered.

A previous closed crawl space research project, co-funded by Advanced Energy and the Department of Energy and titled "A Field Study Comparison of the Energy and Moisture Performance Characteristics of Ventilated Versus Sealed Crawl Spaces in the South" (Davis, 2005), determined that closing a crawl space in the Southeast can save between 15% and 18% on the heating and cooling load for a house. Preliminary runs showed that a popular HERS tool did not accurately predict those savings, so the research team proposed a detailed computer modeling assessment as part of this MPCS follow-up research project.

The first objective of the study is to determine the software applications that may be most applicable for the research project. This is accomplished by inputting three plans from the previous Crawl Space Field Study, one from each test group, and comparing the predicted energy use to the actual energy use.

A second objective is to run all of the floor plans from each test site in the new Project through the selected modeling applications. This will determine the predicted energy use of the house which can then be compared to sub-metered measurements obtained in the field study portion of the project.

For consistency in analyzing the applications, one person was selected to learn and analyze the applications. The process for training this person in each application was to obtain all user manuals, read through the general philosophy and setup of the application, work through the tutorials (if any), and then use the user manuals as guidance when modeling each of the houses. The user manuals were mostly located within the application itself, and most programs also included both a "First-time use" section and more in-depth documentation once the basic operation is understood.

To complete the first objective, an initial list of applications was chosen based on the general user base of the software. The top used applications were placed on the list and a “second tier” group was added based on a lesser, but still substantial, user base. Each application was reviewed on the Building Energy Software Tools Directory (BESTD) located on the DOE web site (Building, 2006) to determine:

- Foundation options (in particular, mention of crawl spaces)
- Climate options
- Usability
- Inputs/outputs
- User base
- Any other information that might prove useful in accepting or rejecting an application.

Reasons for rejecting an application include the application not being available for all climates, not being set up for different types of crawl spaces, not including kWh as an output (some applications use a scoring system, but the research team wants to compare predicted energy use with actual energy use in kWh), and having a low user base.

Once this initial list was compiled, a second screening process was performed to verify the choices. This second selection process involved running each application on three floor plans from the previous Crawl Space Field Study and comparing the predicted to actual heating and cooling energy use.

After choosing applications based on the DOE descriptions and reviews, a test-suite of houses is run through each application to see if it also meets the specific criteria for the Project. The DOE site is a great resource, but not all of the information is present or fully clear in the descriptions. The initial list of applications from the DOE site analysis is:

<u>Application</u>	<u>Version</u>	<u>Developer</u>
AUDIT/RHVAC	7.02.26/8.01.151	Elite Software
Energy-10	1.7	Sustainable Buildings Industry Council
EnergyGauge	2.42	Florida Solar Energy Center
EnergyPlus	1.3	United States Department of Energy
Micropas	6.01	Enercomp, Inc.
REM/Rate	12.11	Architectural Energy Corporation
Right-Suite Residential	6.0.27	Wrightsoft Corporation
TREAT	3.0.19	Performance Systems Development Inc.
VisualDOE	4.1.2	Architectural Energy Corporation.

A set of houses from the previous Crawl Space Field Study were chosen as a test-suite because of their relation to the current closed crawl space project design and because the data was readily available. A description of the experimental setup for this previous project can be found in “Closed Crawl Spaces Do Double-Duty” (Dastur, 2005), and is presented below:

The 12 homes studied in this project are located in the same development in Princeville, North Carolina. Six houses are built, side-by-side, on each side of one street. All are the same size—1,040 ft²—with the same floor plan and window schedule. The development was built on controlled-fill soil to elevate it above the 100-year floodplain, which added to the uniformity of the site soil conditions, and each home site was graded to provide proper drainage.

The study homes are broken into three groups of four homes each: one control group and two experimental groups. We reduced duct leakage and house leakage to comparable levels across all the groups. Average duct leakage varies from 51 CFM₂₅ to 68 CFM₂₅ for these groups, which represents rates of 5%–7% CFM₂₅ per square foot of floor area. Dividing the leakage by the conditioned floor area lets us use a consistent target across many different sizes of home. Average house leakage varies from 0.22 to 0.27 CFM₅₀ per square foot of envelope area. Insulation deficiencies were corrected in all houses, and heat pump refrigerant charge and system air flow were measured and corrected as needed in all houses.

All the houses have a fresh-air ventilation intake integrated with the HVAC ductwork. A 6-inch insulated flex duct from outside routes air through a 1-inch pleated media filter and then connects directly to the return plenum. Whenever the HVAC system is operating, 40 CFM of filtered fresh air is mixed into the return air stream, conditioned, and then distributed to the house. No fan-timing or fan-cycling controls are used in the mechanical system.

The four control houses have conventionally vented crawlspaces, with 11 8 inch x 16 inch foundation vents. Each house has a 6-mil polyethylene ground cover that is mechanically secured to the soil with turf staples. The seams are lapped approximately 6 inches but are not sealed. The ground cover extends completely to the foundation wall and intermediate piers, covering 100% of the soil. Although the building code allows a reduction in the amount of wall venting when a ground vapor retarder is present, all 11 foundation vents were retained. (Note that current North Carolina code does not require the ground vapor retarder, since these vents provide the net free area to meet the 1:150 ventilation area to crawlspace area requirement.) The floors of the control houses are insulated with well-installed R-19 Kraft-faced fiberglass batts.

The crawlspace vents of the experiment homes were sealed with rigid polystyrene foam and mastic or spray foam. Each of these closed crawlspaces has a sealed, 6-mil polyethylene liner covering the floor and extending up the foundation wall, stopping 3 inches from the top of the masonry to provide a termite inspection gap. The seams of the liner are sealed with fiberglass mesh tape and mastic, and the edges are sealed with mastic and mesh tape to the foundation wall or intermediate piers. The liner is mechanically secured to the soil with turf staples and to the foundation wall with a furring strip.

Mechanical drying in the closed crawlspaces is provided by a 4-inch duct that delivers 35 CFM of conditioned air to the crawlspace from the supply plenum whenever the air handler is running. As designed, the extra air simply exfiltrates through the crawlspace perimeter wall. No fan-timing or fan cycling controls are used in the mechanical system, and no stand-alone dehumidifiers are used for moisture control. A balancing damper permits adjustment of the flow, and a backflow butterfly gravity damper with a nonmetallic hinge prevents movement of air from the crawlspace into the supply plenum when the system is off.

Four of the closed crawlspaces are insulated with R-19 kraft-faced fiberglass batts in the floor, and the other four are insulated with 2 inches of R-13 foil-faced polyisocyanurate foam on the perimeter wall and on the band joist. This closed cell foam was installed with a 3-inch gap between the top of the foam and the bottom of the sill plate, to allow for monitoring of termite activity, and there is a second gap at the bottom of the foam insulation to prevent ground contact and wicking of moisture into the foam insulation. This foam meets the ASTM E84 and Factory Mutual FM 4880 requirements of the International Residential Code for use without a thermal barrier. The ground vapor retarder is attached to the inside surface of the foam insulation with fiberglass mesh tape and mastic. We specifically did not install the wall insulation in the typically recommended form, which specifies wall insulation to 24 inches below outside grade or horizontally on top of the soil in from the foundation wall for 24 inches. Instead, the bottom edge of the crawlspace wall insulation extends only 3 to 6 inches below outside soil grade level.

The configurations mentioned above are (1) a traditional wall-vented crawl space (control), (2) a closed crawl space with floor insulation (experiment 1), and (3) a closed crawl space with wall insulation (experiment 2). Data were collected for a one-year period and were combined to give an average yearly kWh usage for each configuration (heating and cooling use only). The actual average heating/cooling energy use for each group can be found in Table 1.

Table 1. Average heating and cooling usage (in kWh) for each experimental group.

	<u>Control</u> (vented)	<u>Experiment 1</u> (closed w/ floor ins)	<u>Experiment 2</u> (closed w/ wall ins)
Heating/Cooling use	5754 kWh	4883 kWh	4729 kWh
Savings over Control	--	15%	18%

Information recorded to determine which application would be chosen includes:

- Input data
- Energy outputs of each application for each crawl space configuration
- Notes on usability and problems encountered with the applications
- Whether the application can model a closed crawl space and a moisture-managed closed crawl space
- Acceptance of the application by RESNET and HERS governing bodies

- HVAC load results
- Baseload usage
- A list to keep track of the applications that will move forward in the project (i.e., be selected for more extensive testing using houses enrolled in the current project).

Both the HVAC load results and baseload usage are not key foci of this report, but the comparison of outputs between all applications might give insight to estimated energy performance. When working through each application, the input data were recorded in an Excel spreadsheet—both the value of the input and applications that used the input. This allows a quick view of the number of inputs required by the user, though the exact number of inputs will be different based on different house configurations and number of defaults used. The Excel input file can be found in the Appendix.

4.1 Background of Selected Software

The applications analyzed in this study are:

- AUDIT 7.02.26/RHVAC 8.01.151 by Elite Software
- Energy-10 1.7 by Sustainable Buildings Industry Council
- EnergyGauge 2.42 by Florida Solar Energy Center
- EnergyPlus 1.3 by United States Department of Energy
- Micropas 6.01 by Enercomp, Inc.
- REM/Rate 12.11 by Architectural Energy Corporation
- Right-Suite Residential 6.0.27 by Wrightsoft Corporation
- TREAT 3.0.19 by Performance Systems Development Inc.
- VisualDOE 4.1.2 by Architectural Energy Corporation.

The following descriptions are compiled from the Building Energy Software Tools Directory (BESTD) (Building, 2006). This site contains information on over 300 energy software packages, including: a general write-up and information about validation/testing, expertise required, users, audience, inputs, outputs, computer platforms, programming languages used to create the software, strengths, weaknesses, contact information, and availability.

When reading through the application descriptions, it may be helpful to note that all applications for this study are run on a Windows XP desktop machine with a 3.40 GHz Intel Pentium 4 processor and 1.00 GB of RAM.

4.1.1 AUDIT v.7.02.26 and RHVAC v.8.01.151 by Elite Software <http://www.elitesoft.com>

These applications are listed together because AUDIT uses the HVAC sizing results from RHVAC to calculate energy usage.

AUDIT:

Closed Crawl Space Performance: Proof of Concept in the Production Builder Market Place
Instrument No. DE-FC26-04NT42319

Calculates monthly and annual heating and cooling costs for residential and light commercial buildings. Virtually any type of cooling and heating system can be simulated by AUDIT including standard DX, evaporative, air source heat pumps, water source heat pumps, and all types of fossil fueled furnaces and boilers (both modulating and on/off controlled). An optional version of AUDIT with appliance capabilities can calculate appliance and hot water energy use as well. AUDIT uses monthly bin weather data and full load cooling hours in its calculations. Weather data for hundreds of cities throughout the world are built-in to AUDIT and additional weather data can be easily added. Along with calculating energy costs, AUDIT also performs an economic analysis that allows you to compare system types and costs over any given study period. There is even a loan and lease analysis report designed to demonstrate affordability of better systems by showing that the effective net monthly cost is often very low when monthly energy savings are considered. To make system comparisons easy, AUDIT allows you to manually enter equipment data or automatically look it up for you from ARI and GAMA equipment data files. AUDIT provides a wide selection of nicely formatted color charts, graphs, and reports. AUDIT shares data with Elite's RHVAC, CHVAC, and Quick Quote programs.

For inputs, two types of data are requested: general project data and specific HVAC system data. The general project data includes the summer and winter design conditions, total cooling hours, the project name and location, client information, fuel cost data, optional appliance data, and the design heating and cooling loads. The HVAC system data includes specific information on the system type, model number, efficiency, cost, capacity, and fuel used. Economic data concerning initial system cost, interest and inflation rates, and loan amounts can also be entered. AUDIT can also import data from project data files created by the Elite's RHVAC and CHVAC load calculation programs. And for outputs, the AUDIT program provides numerous color presentation quality reports including a title page, project summary, system comparisons, appliance analysis, hot water heating, investment, loan, and lease analysis, line graphs, pie charts, and bar graphs. The reports can be previewed on screen or printed on any printer supported by Windows.

BESTD reports that the strengths of the application are minimal input data required for obtaining HVAC operating costs. Great sales tool for showing the benefits of using high efficiency equipment. The weaknesses are the simple and easy to use monthly bin method of calculation does not allow the simulation sophistication provided by hourly energy analysis methods.

BESTD reports that there are over 5,000 users worldwide, and the software can be run on Windows 9x, NT 4.0, 2000, XP, Pentium class processor, 16MB of RAM, and 50MB of hard disk space. Knowledge of

various types of HVAC equipment is helpful. The application is intended for HVAC Contractors and Engineers.

RHVAC:

Calculates peak heating and cooling loads for residential and small commercial buildings in accordance with ACCA Manual J. Heat Transfer Multipliers (HTM values) for all walls, windows, doors, and roofs listed in Manual J are stored and automatically looked up by the RHVAC program as needed. Although HTM values are taken directly from Manual J, users have the option of entering their own U-Value for each wall, roof, or glass section so that a modified HTM value is used. Design weather data for over 1500 cities is built-in to RHVAC. Users can revise existing weather data and add additional weather data as desired. Zoning CFM adjustments are automatically handled by the RHVAC program as needed. Other outstanding features include exterior glass shading, ventilation air, miscellaneous latent loads, default room data, automatic rotation of the entire building, hydronic heat calculations and much more. Besides calculating peak heating and cooling loads, RHVAC also performs run out and main trunk duct sizing, creates sales proposals and selects HVAC equipment. Duct sizing options include all types of duct materials, height and width restrictions, velocity limits, and more. For equipment selection, RHVAC is provided with a database derived from ARI and GAMA of thousands of equipment models from over 80 HVAC manufacturers. Standard air conditioners, heat pumps, furnaces, boilers, and ground source heat pumps are among the types of equipment RHVAC can select. The sales proposal feature of RHVAC prints key features of the proposed equipment and work to be performed. RHVAC shares data with Elite Software's AUDIT operating cost analysis program, DUCTSIZE, and Quick Quote program. Data can be manually entered into RHVAC or it can be automatically taken from a drawing created with Elite's Drawing Board program.

For inputs, two types of data are requested: general project data and specific room data. The general project data includes the summer and winter design conditions, the outside air requirements, exterior shading and overhang data, the project name, the client name, and the designer name. The room input data includes specific information on the roof, walls, doors, and windows as well as general information on the room name, the number of occupants, and the number of appliances. Help is provided on all inputs. Data sheets are also provided for the easy organization of your information. And for outputs, the RHVAC program provides numerous presentation quality reports including a title page, general project data, total building and system load summaries, room summary data grouped by zone, detailed room load reports, sales proposal, and numerous color pie charts and bar graphs.

BESTD reports that the strengths of the application are that it allows for additional loads not covered in Manual J such as lighting, latent equipment, and ventilation air loads thus making it suitable for some light commercial applications. The weaknesses are more input is required than for load programs that only do a whole house analysis.

BESTD reports that there are over 10,000 users worldwide, and the software can be run on Windows 9x, NT 4.0, 2000, XP with Pentium class processor, 16MB of RAM, and 50MB of hard disk space. Knowledge of residential HVAC practices helpful. The application is intended for HVAC contractors and engineers.

4.1.2 Energy-10 v.1-7 by Sustainable Buildings Industry Council <http://www.sbicouncil.org/store/e10.php>

Conceptual design tool focused on making whole-building tradeoffs during early design phases for buildings that are less than 10,000 ft² floor area, or buildings which can be treated as one or two-zone increments. Performs whole-building energy analysis for 8760 hours/year, including dynamic thermal and daylighting calculations. Specifically designed to facilitate the evaluation of energy-efficient building features in the very early stages of the design process.

For inputs, only 4 inputs required to generate two initial generic building descriptions. Virtually everything is defaulted but modifiable. User adjusts descriptions as the design evolves, using fill-in menus, including utility-rate schedules, construction details, materials. And for outputs, summary table and 20 graphical outputs available, generally comparing current design with base case. Detailed tabular results also available.

BESTD reports that the strengths of the application are that it is fast, easy-to-use, [and] accurate. Automatic generation of base cases and energy-efficient alternate building descriptions; automatic application of energy-efficient features and rank-ordering of results; integration of daylighting thermal effects with thermal simulation; menu display and modification of all building-description and other data. The weaknesses are that it is limited to smaller buildings and HVAC systems that are most often used in smaller buildings.

BESTD reports that there are more than 3,200 users worldwide, and the software can be run on PC-compatible, Windows 3.1/95/98/2000, Pentium processor with 32 megabytes of RAM is recommended. Moderate level of computer literacy required; two days of training advised. The application is intended for building designers, especially architects; also HVAC engineers, utility companies, university schools of architecture and architectural engineering.

4.1.3 EnergyGauge USA v.2.42 by Florida Solar Energy Center
<http://energygauge.com/usares/default.htm>

User-friendly residential building energy simulation which allows calculation and rating of energy use of residential buildings around the United States. ENERGYGAUGE USA, takes advantage of current generation personal computers that perform an hourly annual computer simulation in less than half a minute. Includes Manual-J system sizing analysis, and an improvement analysis mode to analyze cost-effectiveness of energy upgrades.

ENERGYGAUGE USA uses DOE-2.1E with a number of enhancements which allow superior simulation of duct air leakage and heat transfer (thermal conditions of zones in which ducts are located strongly affects performance) as well as improved calculation of air conditioners, heat pump and furnaces performance. Slab, crawlspace and basement foundation types are explicitly modeled as is thermal bridging in stud assemblies. Includes enhanced simulation of the impacts of air infiltration and mechanical ventilation systems based on measured, estimated or proposed values. Ability to simulate hourly performance of solar water heating systems as well as grid-interactive solar photovoltaic (PV) systems.

Simplified input with an easy-to-use interface. Detailed schedules and end-use output are available for a variety of residential appliances from lighting down to well pumps! Simple enough to use to rapidly perform Home Energy Ratings (HERS) with a proven hourly calculation engine to provide reliable results. Alternately, ENERGYGAUGE USA is powerful enough to provide utility planners with time-of-day information to evaluate peak demand impact of residential programs.

For inputs, typical homes can be input in ten minutes from take-offs. Input screens allow simplified and detailed description of building geometry, construction characteristics and equipment. Most input values can be defaulted to user-entered preferences or can be quickly entered based on either proposed values or performance measurements from site audits. Extensive component libraries are provided. Range checks and extensive context-sensitive help are available for all inputs. Built-in logic checks help users catch inconsistent data entries. Values are easily entered for schedules and equipment types. TMY2 weather data for 239 U.S. cities are available. Fuel costs, energy conservation measure costs, and mortgage data can be entered by users for economic and financial analysis. And for outputs, detailed annual energy summary reports, detailed description of inputs, HERS reports, Energy Code compliance reports (MEC and IECC),

ENERGY STAR® home qualification reports, and energy use and costs summaries are available. New HERS 2006 procedures and EPA home tax credit compliance calculations is available within latest version. Also, standard DOE-2 reports are available including hourly reports on energy, temperatures and weather conditions with detailed tabular results. Whole house Manual J sizing reports are available for sizing heating and cooling equipment. Improvement analysis allows comparison of multiple individual runs to evaluate annual energy and economic performance. Graphic output of results are included.

BESTD reports that the strengths of the application are fast, easy to use residential analysis tool that relies on detailed simulation. Program has broad applications from code compliance to home energy ratings to buildings research. As example, those interested only in home energy ratings or annual energy use can select appropriate annual energy summary reports, while utilities can select hourly reports to examine impact on peak electrical demand. Enhanced calculation of duct and infiltration losses as well as mechanical ventilation systems can be based on test results. Multi-zone calculations of attic, crawlspace, basement, garage and sunspace provide improved modeling for common residential analysis. Appliances are simulated in much greater detail than usual: for instance load schedules are available for ranges, dryers, refrigerators, lighting and even pools and well pumps. Improvement analysis allows rapid comparison and economic cost-benefit analysis of various alternatives. Many standard reports and financial compliance forms provided. The weaknesses are execution time is approximate six seconds [sic] for an annual simulation on a 2.8 GHz processor. Room-by-room HVAC sizing not available. Multiple-conditioned zones and batch mode processing are under development for Version 3.0.

BESTD does not include the number of users for EnergyGauge USA. The software can be run on PC-compatible, Windows 95/98, NT, 2000, XP, Pentium processor with 16 MB of RAM with a suggested minimum processor speed of 233 MHz. Moderate level of computer literacy with basic understanding of residential construction, appliances and equipment is recommended. The application is intended for residential building designers, residential energy raters, energy auditors, architects, utilities DSM evaluators, code compliance specialists and code officials, weatherization agencies and engineers.

4.1.4 EnergyPlus v.1-3 by United States Department of Energy <http://www.energyplus.gov>

A new generation building energy simulation program that builds on the most popular features and capabilities of BLAST and DOE-2. EnergyPlus includes innovative simulation capabilities including time steps of less

than an hour, modular systems simulation modules that are integrated with a heat balance-based zone simulation, and input and output data structures tailored to facilitate third party interface development. Other planned simulation capabilities include multi-zone airflow, and electric power simulation including fuel cells and other distributed energy systems.

For inputs, EnergyPlus uses a simple ASCII input file. Private interface developers are already developing more targeted / domain specific user-friendly interfaces. See the EnergyPlus web site for up-to-date information on interfaces and other tools for EnergyPlus. And for outputs, EnergyPlus has a number of ASCII output files - readily adapted into spreadsheet form for further analysis.

BESTD reports that the strengths of the application are accurate, detailed simulation capabilities through complex modeling capabilities. Input is geared to the 'object' model way of thinking. Successful interfacing using IFC standard architectural model available for obtaining geometry from CAD programs. Extensive testing (comparing to available test suites) is completed for each version and results are available on the web site. Weather data for more than 900 locations worldwide available on the web site. The weaknesses are text input may make it more difficult to use than graphical interfaces.

BESTD reports that there are over 31,000 users since the first release in April 2001, and the software can be run on Windows 9x/NT/2000/XP and Linux. High level of computer literacy not required; engineering background helpful for analysis portions. The application is intended for mechanical, energy, and architectural engineers working for architect/engineer firms, consulting firms, utilities, federal agencies, research universities, and research laboratories.

4.1.5 Micropas6 v.6.01 by Enercomp, Inc. <http://www.micropas.com>

Easy to use detailed energy simulation program which performs hourly calculations to estimate annual energy usage for heating, cooling and water heating in residential buildings. In addition to its purpose as a compliance tool for California's Title 24 Energy Efficiency Standards, Micropas can be used to demonstrate that a home meets Energy Star requirements in California (15% above Title 24). The program includes a load calculation for use in sizing heating and cooling equipment.

Micropas6 has been in wide use in California since the early 1980s as a building energy code compliance tool and is growing in use elsewhere under the Model Energy Code. The last survey showed that about 75% of the single-family homes permitted in California used Micropas to

determine code compliance. The program is mature, reliable and fast. Micropas6 is fully supported with top notch documentation and complete printouts. The program has a wide range of features to help automate and manage its use.

For inputs, data is [sic] required describing each building thermal zone (15 maximum); opaque surfaces (walls, roofs, floors, 100 maximum); fenestration products (doors, windows, skylights, 100 maximum); thermal mass (slabs, etc., 25 maximum); HVAC equipment (heating, cooling, venting, thermostats) and water heating systems (domestic and hydronic heating). And for outputs, seven types of clearly formatted printouts are available including summary output, detailed building descriptions, HVAC sizing summary and assembly U-value calculations. For detailed oriented studies, yearly, monthly, daily and hourly table output is available including time-of-use and bin data. Annual and table outputs can be saved in delimited formats suitable for importing into other software for additional analysis and graphics. For studies including many runs, a parametric run generator and databases of run results are available.

BESTD reports that the strengths of the application are mature and reliable program used daily by hundreds of energy consultants in California. Good documentation and good support via toll free number. Can calculate annual energy usage and provide load (sizing) calculations at the same time. Able to manage multiple runs. Not as complex as DOE-2, not as simple minded as UA type compliance programs. The weaknesses are no detailed modeling of heating and cooling systems is provided--seasonal performance values like AFUEs and SEERs are used.

BESTD reports that there are over 2,300 users since 1983, and the software can be run on any DOS, Windows 3.1, Windows 95, 98, XP, 2000 or Windows NT based computer. It can also run on Macintosh using emulation software. The application itself runs in DOS. The expertise required is to read building plans and an understanding of how the energy efficiency of building features (e.g. U-factors, SHGC, R-values, SEER, etc.) are specified. Although Micropas is a capable general purpose hourly simulation program for energy efficient residential buildings, the main use of the program is to document compliance with residential building energy codes such as the Model Energy Code and California's Title-24 Code.

4.1.6 REM/RATE v.12.11 by Architectural Energy Corporation <http://www.archenergy.com>

User-friendly, yet highly sophisticated, residential energy analysis, code compliance and rating software developed specifically for the needs of HERS providers. REM/Rate calculates heating, cooling, hot water,

lighting, and appliance energy loads, consumption and costs for new and existing single and multi-family homes. Climate data is available for cities and towns throughout North America. A home energy rating is calculated based on the proposed DOE HERS guidelines (10 CFR 437) as modified by the RESNET/NASEO HERS Technical Committee. In addition to an energy rating, REM/Rate creates value added information including energy efficiency mortgage report, energy appraisal addendum, energy code compliance (MEC, IECC, and ASHRAE), improvement analysis (existing homes), design optimization (new homes), heating and cooling equipment sizing, utility DSM compliance analysis, and U.S. EPA Energy Star Home analysis.

REM/Rate operates in Windows and has many unique features, including a simplified input procedure, extensive component libraries, automated energy efficient improvement analysis, duct conduction and leakage analysis, latent and sensible cooling analysis, lighting and appliance audit, and active and passive solar analysis. In addition, REM/Rate has a User Defined Reference Building feature which enables the HERS provider to create other reference buildings that can be compared to the rated home, and an Export/Archive File feature that creates a file of inputs and outputs that can be imported to database software for statistical analysis, rating archiving and custom report generation.

For inputs, two levels of input: simplified and detailed. Simplified inputs use general building design characteristics (e.g., house type) and built-in algorithms to determine building shell areas and other characteristics. Detailed inputs provide the user greater control over calculation values. Inputs include, opaque wall construction details, window conduction and solar gain values, HVAC efficiencies, duct system characteristics, passive and active solar design features, infiltration rates (measured or estimated). And for outputs, 27 preformatted reports, available for viewing on screen or printing. Reports include rating, quick report, improvement analysis, energy use, energy cost, normalized energy use, design loads, code compliance, and economic analysis of energy upgrades.

BESTD reports that the strengths of the application are considered one of the easiest residential energy analysis and rating tools to use. One of the only tools that allows side-by-side comparison of two homes, making analysis of energy upgrades easy. Automatic improvement analysis makes automated design optimization possible. Multi-purpose tool brings together in a single package the capability to perform home energy ratings, design optimization, improvement analysis, compliance analysis and equipment sizing. The weaknesses are single zone model. Seasonal methodology cannot predict hourly values. Unsophisticated HVAC equipment modeling.

BESTD does not include the number of users for REM/Rate. The software can be run on PC-compatible, Windows 95/98/NT/2000/ME, 8 MB disk space. Medium level of computer literacy required. The application is intended for HERS Providers, weatherization agencies, and energy auditing consultants.

4.1.7 Right-Suite Residential for Windows v.6.0.27 by Wrightsoft Corporation
<http://www.wrightsoft.com>

All-in-one HVAC software performs residential loads calculations, duct sizing, energy analysis, equipment selection, cost comparison calculations, and geothermal loop design. Also allows you to design your own custom proposals. Used for system design, for sales representation, and for quotation preparations. Buy only what you need. Unused functions are shipped as demos, so the program can grow with your needs.

For inputs, building description - dimensions and construction details, all data from Air Conditioning Contractors of America (ACCA) tables selectable from multiple choice list. And for outputs, screen representations and printouts of ACCA forms and additional printed reports, can link to Microsoft Word for custom proposals.

BESTD reports that the strengths of the application are on-screen images of standard load forms are easy to fill in. Since loads and sizes are instantly recalculated instantly whenever input is changed, users can play "What if?" at a high level. Because Loads, Duct Sizing, and Operating Costs are all within the same program, changing any input in loads instantly updates the duct system and operating costs. Pie charts and bar charts give easy graphic display of load components and system comparisons. In addition to standard reports, users can use an OLE link to Microsoft Word, which allows custom proposals using program variables. The weaknesses are calculations only.

BESTD reports that there are over 10,000 users of Right-J loads, and the software can be run on Windows 3.1x or Windows 95, 486 or higher, minimum 8 MB RAM, 21 MB hard disk space (for all options), mouse, 3.5-inch diskette drive, and any printer supported by Windows. Knowledge of general HVAC concepts required, but high level of computer literacy not required. The application is intended for HVAC contractors and other design and sales professionals in the industry.

4.1.8 TREAT v.3.0.19 by Performance Systems Development Inc.
<http://www.TREATsoftware.com>

Performs hourly simulations for single family, multifamily and mobile homes. Comprehensive analysis tool includes tools for retrofitting heating

and cooling systems, building envelopes (insulation and infiltration), windows and doors, hot water, ventilation, lighting and appliances, and more. Weather normalizes utility bills for comparison to performance of model. Highly accurate calculations which consider waste heat (baseload), solar heat gain, and fully interacted energy savings calculations. Create individual energy improvements or packages of interactive improvements. Also performs HERS ratings and load sizing. Generates XML file for upload to online database tracking systems.

For inputs, building components libraries are used to input building geometry and thermal characteristics, heating and cooling equipment and system characteristics, lighting, appliances, ventilation, and hot water. Imports utility bills and daily weather data. And for outputs, 20 user-selected, formatted reports printed directly by TREAT; generates custom program-designed reports for weatherization, home performance programs or HERS providers. Exports project data in XML format which may be uploaded to online database and tracking system.

BESTD reports that the strengths of the application are comprehensive and highly flexible whole building retrofit tool, easy to use graphic user interface which includes libraries of building components (walls / surfaces, windows, doors, appliances, lighting, heating and cooling, and hot water). Performs utility billing analysis including weather normalization. Calculations consider solar heat gain and waste heat generated by baseload and fully interacted savings from energy retrofit measures. The weaknesses are not recommended for commercial buildings with complex HVAC systems.

BESTD reports that there are over 300 users, and the software can be run on CPU: Pentium 300 or higher (600 MHz recommended); RAM: 256 MB (512 MB recommended); operating system: Windows 98/ ME / NT 4.0 service pack 6 / 2000 / XP. Basic computer skills, knowledge of building science, building performance contracting or weatherization retrofit techniques required. The application is intended for Weatherization, Home Energy Raters, Home Performance with Energy Star Contractors, Insulation and Mechanical contractors, and Mechanical or Energy Engineers performing multifamily building energy analysis.

TREAT software is developed and supported by a partnership between Taitem Engineering and Performance Systems Development Inc, under the sponsorship of The New York State Energy Research Development Authority. TREAT utilizes the SUNREL building physics simulation engine developed by the National Renewable Energy Laboratory.

4.1.9 VisualDOE v.4.1.2 by Architectural Energy Corporation
<http://www.archenergy.com/products/visualdoe/>

A Windows interface to the DOE-2.1E energy simulation program. Through the graphical interface, users construct a model of the building's geometry using standard block shapes, using a built-in drawing tool, or importing DXF files. Building systems are defined through a point-and-click interface. A library of constructions, fenestrations, systems and operating schedules is included, and the user can add custom elements as well.

VisualDOE is especially useful for studies of envelope and HVAC design alternatives. Up to 99 alternatives can be defined for a single project. Summary reports and graphs may be printed directly from the program. Hourly reports of building parameters may also be viewed.

For inputs, required inputs include floor plan, occupancy type, and location. These are all that is required to run a simulation. Typically, however, inputs include wall, roof and floor constructions; window area and type; HVAC system type and parameters; and lighting and office equipment power. Smart defaults are available for HVAC systems based on the building vintage and size. A library and templates are provided to greatly ease user input. And for outputs, produces input and output summary reports that may be viewed on-screen, stored as PDF files, or printed. A number of graphs may be viewed and printed. These graphs can compare selected alternatives and/or selected hourly variables. Standard DOE-2.1E reports and hourly reports are available.

BESTD reports that the strengths of the application are allows rapid development of energy simulations, dramatically reducing the time required to build a DOE-2 model. Specifying the building geometry is much faster than other comparable software, making VisualDOE useful for schematic design studies of the building envelope or HVAC systems. Uses DOE-2 as the simulation engine--an industry standard that has been shown to be accurate; implements DOE-2's daylighting calculations; allows input in SI or IP units; imports CADD data to define thermal zones. For advanced users, allows editing of equipment performance curves. Displays a 3D image of the model to help verify accuracy. Allows simple management of up to 99 design alternatives. Experienced DOE-2 users can use VisualDOE to create input files, modify them, and run them from within the program. The interface is designed to be able to incorporate other energy simulation engines like EnergyPlus. A live update program can be used to check and install latest updates via the internet. Responsive technical support is provided. Periodic training sessions are available. The

weaknesses are VisualDOE implements about 95% of DOE-2.1E functionalities which is adequate for most users. Advanced users familiar with DOE-2.1E can implement the remaining 5% features by modifying the DOE-2 input files generated by VisualDOE.

BESTD reports that there are over 1000 users, and the software can be run on Windows 95/98/NT/ME/2000/XP. 486 or better, 16MB+ RAM, and 50MB hard drive space. Basic experience with Windows programs is important. Familiarity with building systems is desirable but not absolutely necessary. One to two days of training is also desirable but not necessary for those familiar with building modeling. The application is intended for Mechanical/electrical/energy engineers and architects working for architecture/engineering firms, consulting firms, utilities, federal agencies, research universities, research laboratories, and equipment manufacturers.

4.2 Acceptance of Software in Modeling Community

Of the applications listed above, three are accredited by Residential Energy Services Network (RESNET) to be used for Home Energy Rating System (HERS) ratings. These applications, EnergyGauge, REM/Rate, and TREAT, are also three of the easiest to learn and use. To be accredited, an application must be developed to comply with the “2006 Mortgage Industry National Home Energy Rating System Standards” (Mortgage, 2006) and pass a software verification test suite to verify tool accuracy and comparability. Descriptions of the tests from the verification test suite, taken from “Procedures for Verification of RESNET Accredited HERS Software Tools” (Procedures, 2006), are listed below.

1. **Tier one of the HERS BESTEST** – HERS BESTEST was developed by the National Renewable Energy Laboratory (NREL) for testing the building load prediction accuracy of simulation software. (See Section 3.1 of the *Procedure for Verification*.)
2. **HERS Reference Home auto-generation tests** – These tests verify the ability of the software tool to automatically generate the HERS Reference Home. (See Section 3.2 of the *Procedure for Verification*.)
3. **HERS method tests** – These tests verify that software tools can accurately calculate the HERS Index that is used as the numerical indicator of relative performance for a home. (See Section 3.3 of the *Procedure for Verification*.)
4. **HVAC tests** – These tests verify the accuracy and consistency with which software tools predict the performance of HVAC equipment, including furnaces, air conditioners, and air source heat pumps. (See Section 3.4 of the *Procedure for Verification*.)
5. **Duct distribution system efficiency tests** – These tests verify the accuracy with which software tools calculate air distribution system losses. ASHRAE Standard 152 results are used as the basis for the test suite acceptance criteria. (See Section 3.5 of the *Procedure for Verification*.)

- 6. Hot water system performance tests** – These tests determines the ability of the software to accurately predict hot water system energy use. (See Section 3.6 of the *Procedure for Verification*.)

4.3 Previous Software Reviews

A study from the Lawrence Berkeley National Laboratory was conducted to address the many residential energy analysis tools on the market. Ideas from this study have been included in the discussion below. In the LBNL study, 50 web-based residential calculators and 15 disk-based residential calculators were reviewed “to provide information for defining the desired characteristics of residential energy tools, and to encourage future tool development that improves on current practice” (Mills, 2002). Five applications reviewed by the LBNL are included below, though the versions below are newer and may have been overhauled since the LBNL study. Both the LBNL study and this project started with the online version of the DOE Building Energy Software Tool Directory.

Additional software reviews are mentioned on page 5 of the LBNL study. The difference between the Project and all of these other studies mentioned in the LBNL study, including the LBNL study itself, is the focus on the crawl space to determine which applications best predicts the effects of various crawl space configurations on energy use.

5. PROCEDURES AND METHODS

When reviewing the applications, the underlying thought is to assume all of the applications will move forward unless a major flaw emerges (not having the ability to model both vented and closed crawl spaces, for instance) or if the application is too unwieldy.

Various aspects of the applications are recorded when modeling the three configurations to help in the decision-making process. These include a list of the inputs, general characteristics (approvals by various rating programs around the country, previous testing of the applications, etc.), notes of problems and work-arounds for those problems, energy outputs, and heating and cooling loads. A major flaw will immediately remove a program from the list, but removing a program because of unwieldiness or another reason is based on comparisons between programs and cannot be easily defined until after all the applications have been analyzed. One possible instance of a comparison criterion is the comparison of energy outputs. If an application predicts an energy usage that is far from the actual energy consumption and/or far from the energy usage predicted by other applications, it may be removed from the list.

The process for analyzing an application begins with reviewing the applications in the Building Energy Software Tools Directory (BESTD) located on the Department of Energy’s website (Building, 2006) and determining an initial list of applications that seem promising for use in this study. In particular, the applications are reviewed for:

- Foundation options (in particular, mention of crawl spaces)
- Climate options
- Usability
- Inputs/outputs
- User base
- Any other information that might prove useful in accepting or rejecting an application

Based on the BESTD analysis, a set of applications is selected to be used in the Marketplace Performance Crawl Space Project. Each application is then installed and the necessary literature is reviewed (user manuals, “First-time use” documents, FAQs, etc.). The pre-screening process of using previous data sets from the Princeville Field Study (Davis, 2005) to verify the qualities analyzed in the BESTD review is then begun. This is done by inputting the data sets into each application using the recommended process from the application documentation. During the input process, the following information is recorded:

- Specific inputs used—type and value
- Problems with inputting values
- Any solutions to these problems
- General thoughts on ease of use
- Ability to model certain types of crawl space designs
- Energy outputs—heating, cooling, domestic water heating, baseloads
- HVAC design loads

After all of the applications are run, they are then reviewed against each other to determine which applications will be used in modeling the houses in the Marketplace Performance Crawl Space Project. This elimination/acceptance process begins with removing any applications that have “fatal” flaws with regards to this project— not being set up for different types of crawl spaces, inability to differentiate different types of crawl spaces, not being available for all climates in the United States (lower 48 at least), and not including kWh as an output (some applications use a scoring system, but we want to compare predicted energy use with actual energy use in kWh). The remaining applications are then compared on the basis of the number of inputs, ease of use (this usually ties in closely to number of inputs), and energy use predictions. A final list of applications is then compiled to be used in the next phase of the MPCS Project.

This space is reserved to discuss process of analyzing participating houses in chosen applications.

6. RESULTS

Before listing details of each program, one statement that is true for all of the programs is that *none* were able to model a moisture-managed crawl space as designed in this study. This means the most cost-effective, market-ready moisture-managed crawl space systems cannot be modeled—this is a great improvement opportunity for application developers.

The closed crawl space design for this project, calls for a supply duct, but no return duct, in the crawl space to help maintain relative humidity levels. For this reason, modeling of the closed crawl space was completed by running both a conditioned simulation and an unconditioned simulation, when possible, to determine the better strategy for estimating energy use.

The applications with major flaws with respect to this analysis are AUDIT/RHVAC, Energy-10, Micropas, and VisualDOE, so these programs have been eliminated from the final list. Table 2 lists a brief description of the major flaws in the applications.

Table 2. List of applications with major flaws with respect to the Marketplace Performance Crawl Space Project.

<u>Application</u>	<u>Flaw</u>
AUDIT/HVAC	Not able to compare closed to vented crawl spaces
Energy-10	Not able to compare closed to vented crawl spaces
Micropas	Regional-specific to California
VisualDOE	Commercial-focused, difficult to create different types of crawl space design

Both AUDIT/RHVAC and Energy-10 did not have an option to compare closed to vented crawl spaces, and Micropas is regional-specific to California. VisualDOE has a commercial-focused approach and it is difficult, if possible at all within accuracy, to create the closed crawl space versus vented crawl space conditions needed for this study. The process for creating the crawl spaces in VisualDOE is to model the floor as a “R-0 Mass” and the vents as windows with high u-values. The first assumption, the “R-0 Mass” floor removes some of the thermal and moisture connections that a crawl space has with the physical ground. The second assumption, modeling the vents as windows, removes one of the largest assumptions of the project, that the vented crawl space is used to provide air to the crawl space.

EnergyPlus has also been removed from the list because of complexity and for the method of creating a vented crawl space. After the initial house was entered into the application window, there were over 2000 inputs, not counting the libraries that were imported. Compared to the 100-200 inputs most of the other applications require, this application is exceptionally cumbersome. To give an example of the detail level, the inputs included the need to geometrically determine and input every vertex of the walls, doors, and windows. In addition, EnergyPlus uses a similar method to creating the crawl space as VisualDOE—the ground is modeled as a floor, which removes some of the thermal and moisture connections that a crawl space has with the physical ground, and the vents are modeled as windows, which removes one of the largest assumptions of the project, that the vented crawl space is used to provide air to the crawl space. The outputs of EnergyPlus are also complex and do not include HERS, Energy Star, or IECC results.

This leaves four applications on the list: EnergyGauge, REM/Rate, Right-Suite Residential, and TREAT. As mentioned earlier, the three applications approved by RESNET were some of the easiest programs to learn and use—these are EnergyGauge,

REM/RATE, and TREAT. However, none of the applications were perfect and notes for each application, including problems and work-arounds, and any other comments, are included below. The full strengths and weaknesses of each application will be included after the full modeling is performed on all houses in the Marketplace Performance Crawl Space Project.

EnergyGauge

When looking at the cost of energy use, EnergyGauge only allows a single utility rate to be used. In the Princeville Field Study, for instance, the electric utility uses one rate for November through June and a second rate for energy used in July through October. This provides an inaccurate tool for budget analyses.

Other items that stuck out when working through EnergyGauge was the application automatically chooses drapes and shades for interior shading, and there is no use of cooling degree hours or days (but there is use of heating degree days). These are both algorithmic items and may be inconsequential based on how the energy use is calculated.

One design option that is different in EnergyGauge than some of the other applications is that EnergyGauge does not have an option for fully conditioning a crawl space. Since none of the programs were able to model the crawl space as designed in the MPCCS Project, an analysis of both unconditioned and conditioned crawl spaces is performed on each application to see which option provides the closest energy prediction—only the unconditioned option will be performed for EnergyGauge.

There are two additional notes with EnergyGauge, the first is to be sure to use “Parameters and Schedules” option in order to include more inputs in modeling a house. The second is more of a “program design thought process” note that EnergyGauge uses u-value averages to model walls. Other programs use r-values of different layers of the walls and ask for frame spacing in order to calculate the thermal pattern of the wall. In EnergyGauge, this is all done by the user (by hand) and inputted simply as a wall u-value (this can be seen as a simplification of inputs, allowing a quicker turnaround in providing energy analyses).

REM/Rate

There were not many notes when performing the REM/Rate analysis. Only one item was noted to be different in inputting the parameters, the design heating temp in weather inputs is 26 in REM 12, rather than the input of 21 in REM 11. This is simply an algorithmic detail. REM/Rate is used for HERS raters and Energy Star compliance and has been used extensively by Advanced Energy. This provides a familiarity with the software that may mask nuances in the application that are apparent to first-time users.

Right-Suite Residential

Right-Suite is most known for its HVAC calculations (see description in section 4.1.7), so the energy analysis part of Right-Suite Residential pulls from this strength. However, there are items that cannot be inputted into the application that would seem to have a large impact on the HVAC system. This again, though, is an algorithmic detail and may be inconsequential. Regardless, the items noted when working through the application are not having inputs for exact duct leakage (all calculated), no option for R-13 crawl wall insulation (R-11 is the closest), and no inputs for fresh air ventilation.

Other items to note are the inability to do fully conditioned crawl spaces (similar to the issue in EnergyGauge, see above), no baseload use is calculated, and there is no difference in energy outputs for different crawl space configurations.

TREAT

The general overview of TREAT is that it does not have the level of detail as some of the other programs. Depending on the algorithm and outputs, this can be a great advantage or disadvantage compared to other programs. Less inputs with the same accuracy allows for a quicker and simpler energy analysis, but a decrease in inputs can also lead to a decrease in accuracy. This issue can be better addressed later in the project when all of the modeling and actual energy usage is known for the houses in this MPCs Project.

There are many items affected by this simplification of inputs, a few of which are mentioned here:

- The unconditioned space floor must be adjacent to some kind of floor other than the ground, which is similar to VisualDOE and EnergyPlus
- Like EnergyGauge, TREAT is only able to use one utility rate (no summer/winter schedules)
- Raleigh is closest weather data location to Princeville (instead of Greenville like some other applications) as shown in Table 3.

Table 3. Quick weather comparison of Raleigh, NC and Greenville, NC to Princeville, NC.

	<u>Dist from Princeville</u>	<u>Elevation</u>	<u>Avg Rain</u>	<u>Precip Days</u>	<u>July High</u>	<u>Jan Low</u>
Princeville	0 mi	82 ft	46 in	114	89.7	29.7
Greenville	25 mi SSE	59 ft	49 in	114	90.9	31.6
Raleigh	70 mi W	366 ft	46 in	113	87.9	29.9

- Items that cannot be customized: door, wall, insulation, windows to some degree
- Not as detailed as some other applications for interior window shading

- Vented crawl is modeled as “unheated high ACH” and closed crawl is modeled as “unheated low ACH”
- The attic space was modeled as “unheated high ACH” to account for a vented attic space
- In many instances, the program did not have, or allow, exact parameter inputs—the choices come from a predetermined list

From an energy standpoint, the outputs (in kWh) for each of the programs can be found in Table 4. In order to check for bias in using actual house and duct infiltration values, Table 5 is included to show the estimated energy differences based solely on the crawl space configuration differences (constant infiltration values except where affected by crawl space design).

Table 4a-c. Total heating and cooling estimates (in kWh) for each of the remaining applications. The abbreviation “cond” stands for “conditioned” and refers to the modeling type for the HVAC system in the crawl space. Note that no program allowed for a conditioned space under an insulated floor. The values in parentheses are percent differences from the actual energy usage. The applications are listed in order by these percent differences (lowest first, by absolute value, and using the “Total” column). The three tables represent data for the Control, Experiment 1, and Experiment 2 setups.

Table 4a. Control—vented with no conditioning of the crawl space.

	<u>Heating</u>	<u>Cooling</u>	<u>Total</u>
<i>Actual</i>	2771	2984	5754
REM12	2623 (-5%)	2445 (-18%)	5068 (-12%)
RIGHT-SUITE	3184 (+15%)	1462 (-51%)	4646 (-19%)
ENERGYGAUGE	1754 (-37%)	2635 (-12%)	4389 (-24%)
TREAT	2856 (+3%)	3161 (+6%)	6018 (+5%)

Table 4b. Experiment 1—closed crawl space with floor insulation.

	<u>Heating</u>		<u>Cooling</u>		<u>Total</u>	
	no cond	cond	no cond	cond	no cond	cond
<i>Actual</i>	2472		2410		4883	
REM12	2634 (+7%)	n/a	2522 (+5%)	n/a	5156 (+6%)	n/a
RIGHT-SUITE	3211 (+30%)	n/a	1462 (-39%)	n/a	4673 (-4%)	n/a
ENERGYGAUGE	1570 (-36%)	n/a	2636 (+9%)	n/a	4206 (-14%)	n/a
TREAT	2994 (+21%)	n/a	3167 (+31%)	n/a	6161 (+26%)	n/a

Table 4b. Experiment 2—closed crawl space with wall insulation.

	<u>Heating</u>	<u>Cooling</u>	<u>Total</u>
--	----------------	----------------	--------------

	no cond	cond	no cond	cond	no cond	cond
<i>Actual</i>	2806		1923		4729	
REM12	2761 (-2%)	2417 (-14%)	2509 (+30%)	2417 (+26%)	5270 (+11%)	4834 (+2%)
RIGHT-SUITE	3167 (+13%)	n/a	1462 (-24%)	n/a	4629 (-2%)	n/a
ENERGYGAUGE	1546 (-45%)	n/a	2448 (+27%)	n/a	3994 (-16%)	n/a
TREAT	4000 (+43%)	2713 (-3%)	3017 (+57%)	3324 (+73%)	7016 (+48%)	6037 (+28%)

Table 5. Total heating and cooling estimates (in kWh) for each application with constant infiltration as described in Table 4. Applications are listed in the same order as Table 4.

	<u>Control</u>	<u>Experiment 1</u>		<u>Experiment 2</u>	
	(vented)	(closed w/ floor ins)		(closed w/ wall ins)	
	no cond	no cond	Cond	no cond	cond
REM12	5068	5209	n/a	5317	4887
RIGHT-SUITE	4646	4646	n/a	4646	n/a
ENERGYGAUGE	4389	4267	n/a	4020	n/a
TREAT	6018	6161	n/a	7102	5740

Two ways to portray this data are to compare the energy predictions to the actual usage and to compare the experimental treatments for energy savings trends. The first of these ideas is portrayed in Figure 1 with each application being easily compared to the actual energy use. In Figure 2, the outputs of each application are placed next to each other to see which programs follow the trend of the actual data.

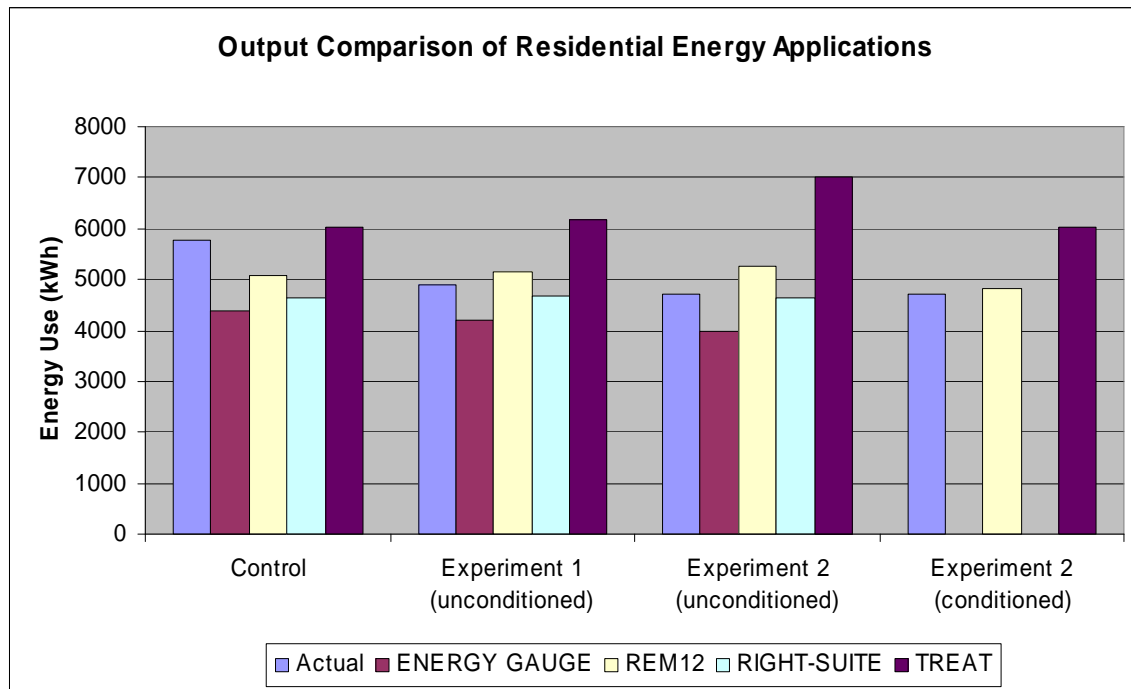

Figure 1. Energy outputs to compare applications against the actual energy usage.

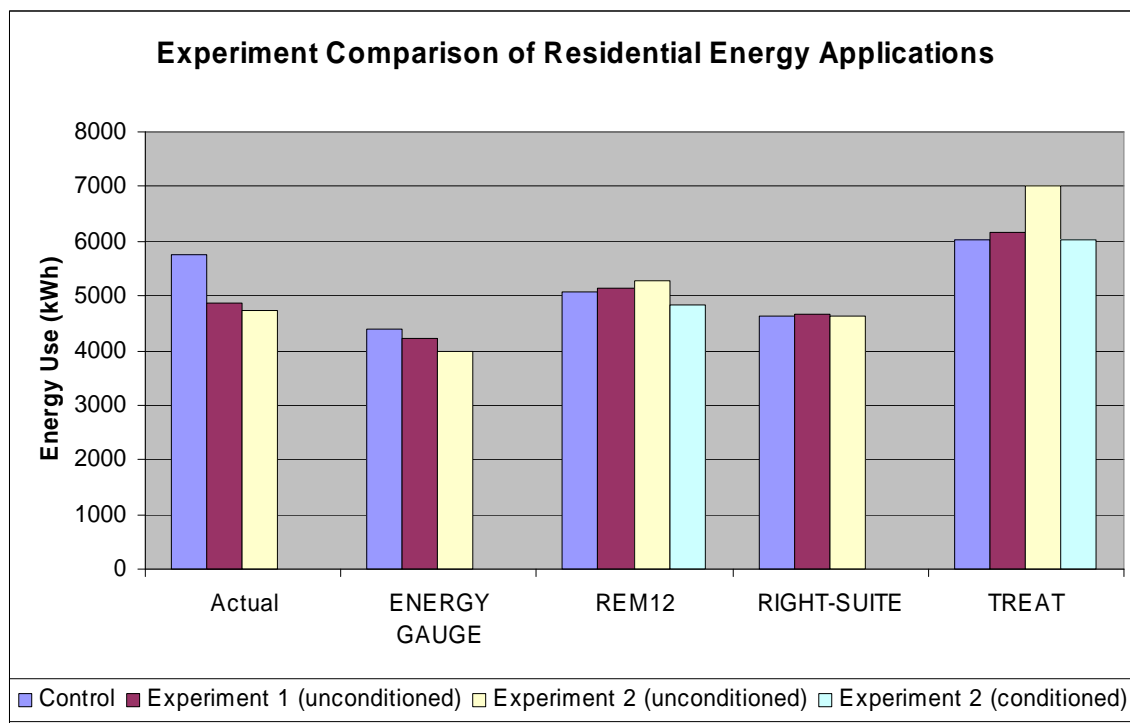

Figure 2. Energy outputs to compare experimental design trends for each application and the actual energy usage.

Additional information recorded during this pre-screening process includes HVAC loads and baseloads. These items are not explicitly stated in the problem statement for this project, but they are included here as an additional tool for looking at the applications. Table 6 displays the design loads for the HVAC system across the applications that provided this data. Table 7 shows the calculated baseloads and domestic water heating energy use across applications.

Table 6. HVAC design loads across applications.

<u>Application</u>	<u>Heating Load</u>	<u>Cooling Load</u>
AUDIT/RHVAC	16.6	15.0
EnergyGauge	19.2	16.7
REM/Rate	20.1	17.1
Right-Suite	18.8	12.5
TREAT	19.2	16.1

Table 7. Baseloads and domestic hot water (DHW) energy use across applications. The values in parentheses are percent differences from the actual energy use.

<u>Application</u>	<u>Baseload</u>	<u>DHW</u>
Actual	7508	
EnergyGauge	13211 (+76%)	4482
REM/Rate	8264 (+10%)	3459
Right-Suite	n/a	3288
TREAT	13318 (+77%)	5169

The remainder of this section is reserved for reporting the energy modeling and actual energy consumption results for each participating house in the Project.

7. FINDINGS

When looking at the results, the first item that needs to be addressed is the inability of Right-Suite to predict a change in energy use across different crawl space configurations. This can best be seen in Table 5 where the actual infiltration values have been replaced with a generic value to provide consistency for all inputs except those affected by the crawl space designs. When comparing to actual energy use, the actual infiltration values were used to determine if the applications could accurately predict energy use given the most accurate set of input data. However, to compare predicted energy use changes based on the crawl space design alone, constant infiltration values were assigned to the experimental groups, except where the design affects the infiltration. Therefore, Right-Suite is removed from the list of applications.

It is interesting to note that the predicted energy use from the applications seems closer in Experiments 1 and 2 rather than in the Control. This viewpoint comes from looking at Figure 1 and seeing the programs better align themselves around Experiments 1 and 2 rather than being below the actual energy use, as in the Control case. Since there were a small number of houses and the focus of this part of the paper is to make a simple and general recommendation of modeling applications to use in the rest of the study, no statistical analysis was performed to determine the significance of the differences in energy use.

Another interesting trend, however, is to look at Figure 2 and see which applications predicted the general downward trend seen in the actual data across the three groups. The only application that follows this trend is EnergyGauge, though all of the predicted outputs are lower than the actual energy use for this application.

Looking further down the road in this project, the above basic application conclusions (energy use accuracy, for instance) may change based on a larger data set, variation in climates, and other unforeseen variables. The analysis described gives a foundation for performing a more complete analysis once the houses for the Marketplace Performance Crawl Space Project are chosen and actual energy use is recorded.

The remainder of this section is reserved for reporting the energy modeling and actual energy consumption findings for each participating house in the Project.

8. RECOMMENDATIONS

This Computer Modeling study has examined the capability of several current computer energy modeling programs to accurately predict the energy consumption of house with a closed crawl space and known energy consumption. It is recommended based on successfully meeting the deliverables of budget period one that funding continue into budget period two in order to document the ability of these modeling tools to predict energy consumption of detached single family residential structures with a closed crawl space, as compared to actual metered heating and cooling energy data. Presently the research team has narrowed this list to three of the most popular energy modeling tools: EnergyGauge, REM/Rate, and TREAT.

Continuation the project into activity funded by NCEMBT, researchers will create a unique modeling file in each of the three chosen software applications for every built combination of floor plan, solar orientation, and crawl space type. The resulting software outputs will be compared to the actual energy results collected from the field sites, to identify the need, if any, to modify the software applications to provide accurate results.

Accurate predictions from these software applications are critical to ensure that closed crawl spaces get their due respect for providing energy savings. Such savings predictions will encourage commercialization because they provide necessary documentation for tax credit programs and can be marketed to consumers.

9. REFERENCES

“Building Technologies Program: Building Energy Software Tools Directory.” http://www.eere.energy.gov/buildings/tools_directory. Accessed July 2006. Cited as (Building, 2006).

Davis, B., Dastur, C., Warren, W. “A Field Study Comparison of the Energy and Moisture Performance Characteristics of Ventilated Versus Sealed Crawl Spaces in the South.” Department of Energy Instrument # DE-FC26-00NT40995. June 22, 2005. Cited as (Davis, 2005).

Dastur, C., Davis, B. “Closed Crawl Spaces Do Double Duty.” *Home Energy*. January 2005. Cited as (Dastur, 2005).

Mills, Evan. “Review and comparison of web- and disk-based tools for residential energy analysis.” Lawrence Berkeley National Laboratory. LBNL’50950. 2002. Cited as (Mills, 2002).

“Mortgage Industry National Home Energy Rating Systems Accreditation Standards.” RESNET and the National Association of State Energy Officials. Amended June 15, 2002. Accessed from <http://www.natresnet.org/standards/standards.pdf>. Cited as (Mortgage, 2002).

“Procedures for Verification of RESNET Accredited HERS Software Tools.” Residential Energy Services Network, Inc. RESNET Publication No. 06-002. March 2006. Accessed from <http://www.natresnet.org/programs/software/verification.pdf>. Cited as (Procedures, 2006).

“RESNET - About Home Energy Ratings and Mortgages.” <http://www.natresnet.org/ratings/default.htm>. Accessed August 16, 2006. Cited as (RESNET, 2006).

“PestOne: Into the Future.” <http://www.pestone.com/>. Accessed August 2006. Cited as (www.pestone.com)

“U.S. Department of Energy – Energy Efficiency and Renewable Energy Building Technologies Program – Building America Project Management.” http://www.eere.energy.gov/buildings/building_america/cfm/project_locations.cfm?print. Accessed January, 2006. Cited as (Climate Zone Map, 2006).

“National Weather Service Forecast Office: Flagstaff, AZ” <http://www.wrh.noaa.gov/fgz/science/monsoon.php?wfo=fgz>. Accessed May, 2006. Cited as (Monsoon, 2006).

“AccuStar: Professional Radon Laboratory Services Since 1984.”
http://www.accustarlabs.com/shop_homeownerLongDescription.php?Product_ID=4&page=1. Accessed May, 2006. Cited as (AccuStar, 2006)

10. APPENDIX

Detailed model inputs.

Excel Input File (items highlighted in yellow represent inputs that are different between crawl space configurations)

After REM11, Treat, EnergyGauge, REM12, Micropas, VisualDOE, Energy10, Elite, Energy-10, Rightsuite

July 28, 2006

Input	Conditioned Crawl - Wall	Unvented Crawl - Floor	Unvented Crawl - Wall	Vented Crawl	REMRate v 11.41 (original data)	Elite Audit 7.02.26/Rhvac 8.01.15	Energy-10 v1-7	EnergyGauge USA 2.42	EnergyPlus v1.3	MICROPAS 6.01	Right-Suite v 12.11	TREAT 3.0.19	VisualDOE 6.0.27	Additional Comments
General House Characteristics														
building use	residential	residential	residential	residential			x							
house area cond space (sqft)	1040	1040	1040	1040	x	x	x	x		x	x	x		
house width	40	40	40	40		x	x				x		x	
house depth	26	26	26	26		x	x				x		x	
default ceiling height	8	8	8	8		x		x			x	x		
floor to floor height (main floor)	10	10	10	10									x	
floor to floor height (crawl space)	2.5	2.5	2.5	2.5									x	
NS facades height	13	13	13	13			x							
EW facades height	13	13	13	13			x							
house volume cond space (cuft)	8320	8320	8320	8320	x	x	x	x		x	x			
house type	detached	detached	detached	detached	x	x			x	x	x	x		
number of dwelling units	1	1	1	1									x	
house floors on or above grade / number of stories	single	single	single	single	x	x	x	x	x	x	x	x	x	
house number of bedrooms	3	3	3	3	x			x		x	x	x		
house number of occupants	4 (2A, 2C)	4 (2A, 2C)	4 (2A, 2C)	4 (2A, 2C)		x	x				x	x	x	
living space hours occupied per day	16	16	16	16		x	x				x	x		
house foundation type	cond crawl space	enclosed crawl	enclosed crawl	enclosed crawl	x					x	x		D	1
house enclosed crawl space type	n/a	unvented	unvented	vented	x	x	x			x	x			
drywall thickness (in)	0.5	0.5	0.5	0.5	x					x				
building info status	New (insp & test)	New (insp & test)	New (insp & test)	New (insp & test)				x						
worst case	no	no	no	no	?			x		?		?		
entry mode	detailed	detailed	detailed	detailed				x						
front orientation	90	90	90	90			x		x		x		x	
zoning	single zone	single zone	single zone	single zone		x					x		x	
Crawl Space														
found wall name	R-13 on block, 6" gap	uninsulated block	R-13 on block, 6" gap	uninsulated block	x					x			x	
found wall type	block: uninsulated cores	block: uninsulated cores	block: uninsulated cores	block: uninsulated cores	x					x				
found wall thickness (in)	6	6	6	6	x					x		D	x	2
found wall studs	none	none	none	none	x					x				
found wall int cont r-val	13	0	13	0	x			x		x	x	D	x	3
found wall int frame cavity r-val	0	0	0	0	x					x		x	x	
found wall int insulation top edge (ft from top)	0.5	0	0.5	0	x					x				
found wall int insulation bottom edge (ft from bottom)	0	0	0	0	x					x				
found wall ext r-val	0	0	0	0	x					x		x		
found wall ext insulation top edge (ft from top)	0	0	0	0	x					x				
found wall ext insulation bottom edge (ft from bottom)	0	0	0	0	x					x				
found wall length (ft)	132	132	132	132	x		x			x		x		
found wall height (ft)	2.5	2.5	2.5	2.5	x					x		x		4
found wall height above grade (ft)	2.5	2.5	2.5	2.5	x					x		x		
found wall depth below grade (ft)	0	0	0	0	x					x		D		5
crawl space elevation	0	0	0	0									x	
found wall location	tw n enc crwl amb/grnd	n enc crwl amb/grnd	tw n enc crwl amb/grnd	n enc crwl amb/grnd	x					x				
crawl space conditioned	yes	no	no	no							x	x	x	
crawl space occupied hrs/day	0	0	0	0								x	x	
crawl space persons	0	0	0	0								x	x	
crawl space natural ventilation	yes	yes	yes	yes								x		
crawl space space type	unheated low ACH	unheated low ACH	unheated low ACH	unheated high ACH								x		

Input	Conditioned Crawl - Unvented Crawl - Unvented Crawl - Vented Crawl				<div style="display: flex; justify-content: space-between;"> REIMRate v 11.41 (original data) Elite Audit 7.02.26/RHVac 8.01.151 </div> <div style="display: flex; justify-content: space-between;"> Energy-10 v1-7 EnergyGauge USA 2.42 </div> <div style="display: flex; justify-content: space-between;"> EnergyPlus v1-3 MICROPAS 6.01 </div> <div style="display: flex; justify-content: space-between;"> REIMRate v 12.11 Right-Suite Residential 6.0.27 </div> <div style="display: flex; justify-content: space-between;"> TREAT 3.0.19 VisualDOE 4.1.2 </div>										Additional Comments						
	Wall	Floor	Wall	Floor																	
Floor																					
frame floor type	n/a	R-19	uninsulated	R-19	x										x	x					
frame floor area (sqft)	n/a	1040	1040	1040	x	x	x	x							x					x	
aspect ratio																					
frame floor location	n/a	vn cond spc enc crwl	vn cond spc enc crwl	vn cond spc enc crwl	x										x	x	x				
frame floor input	n/a	quick fill site-built	quick fill site-built	quick fill site-built	x										x						
frame floor cont insulation r-val	n/a	0	0	0	x		x								x					x	
frame floor cavity insulation r-val	n/a	19	0	19	x	x	x	x							x	x				D	
frame floor cavity insulation thickness (in)	n/a	6.5	0	6.5	x		x								x					x	
frame floor joist size (w x h, in)	n/a	1.5 x 9.5	1.5 x 9.5	1.5 x 9.5	x										x					x	
frame floor joist spacing (in oc)	n/a	16	16	16	x										x					x	
frame floor floor covering	n/a	carpet	carpet	carpet	x	x		x							x	x					
frame floor framing factor	n/a	0.13 (default)	0.13 (default)	0.13 (default)	x		x	x							x						
u-value				0.049												x					
Rim/Band Joist																					
rim/band joist area (sqft)	132	132	132	132	x		x								x					x	
rim/band joist cont ins r-val	0	0	0	0	x										x					x	
rim/band joist frame cavity ins r-val	13	13	13	0	x										x						
rim/band joist cavity ins thickness (in)	3.5	3.5	3.5	0	x										x						
rim/band joist spacing (in oc)	16	16	16	16	x										x					x	
rim/band joist location	btwn cond spc amb	btwn enc crwl amb	btwn enc crwl amb	btwn enc crwl amb	x										x					x	
Walls																					
above-grade wall type	R-13	R-13	R-13	R-13	x										x	x				x	
above-grade wall construction	standard wood frame	standard wood frame	standard wood frame	standard wood frame	x	x		x							x	x	x			x	
above-grade wall cont r-val	0	0	0	0	x	x	x	x							x	x				D	
above-grade wall frame cavity ins r-val	13	13	13	13	x	x	x	x							x	x	x			x	
above-grade wall cavity ins thickness (in)	3.5	3.5	3.5	3.5	x		x								x					x	
above-grade wall block cavity ins r-val	0	0	0	0	x		x								x					x	
above-grade wall gypsum thickness (in)	0.625	0.625	0.625	0.625	x										x					x	
above-grade wall stud spacing (in oc)	16	16	16	16	x										x					x	x
above-grade wall stud width (in)	1.5	1.5	1.5	1.5	x										x						
above-grade wall stud depth (in)	3.5	3.5	3.5	3.5	x	x	x								x					x	
above-grade wall framing factor	0.23 (default)	0.23 (default)	0.23 (default)	0.23 (default)	x		x	x							x						
above-grade wall gross area (sqft)	1056	1056	1056	1056	x			x							x					x	
above-grade wall exterior color (treat absorptivity)	medium (0.6)	medium (0.6)	medium (0.6)	medium (0.6)	x		x	x							x					x	
above-grade wall location	btwn cond spc amb	btwn cond spc amb	btwn cond spc amb	btwn cond spc amb	x			x							x					x	
u-value	0.091	0.091	0.091	0.091												x					
Windows																					
window front type	double-vinyl low-e	double-vinyl low-e	double-vinyl low-e	double-vinyl low-e	x		x	x							x	x	x				
window front area (sqft)	26.6 (2 x 2850)	26.6 (2 x 2850)	26.6 (2 x 2850)	26.6 (2 x 2850)	x	x	x	x							x	x	x			x	x
window front orientation	east	east	east	east	x	x	x	x							x	x	x			x	x
window front u-value	0.46	0.46	0.46	0.46	x	x	x	x							x	x	x			x	x
window front shgc	0.57	0.57	0.57	0.57	x	x	x	x							x					x	x
window front overhang depth (ft)	0	0	0	0	x	x	x	x							x						
window front overhang to top of window (ft)	0	0	0	0	x	x	x	x							x						
window front overhang to bottom of window (ft)	0	0	0	0	x										x						
window front overhang int shad winter	1	1	1	1	x										x						
window front overhang int shad summer	1	1	1	1	x										x						
window front overhang adj shad winter	none	none	none	none	x										x						
window front overhang adj shad summer	none	none	none	none	x										x						

Closed Crawl Space Performance: Proof of Concept in the Production Builder Market Place
Instrument No. DE-FC26-04NT42319

Input	Conditioned Crawl - Unvented Crawl - Unvented Crawl - Vented Crawl				REMRate v 11.41 (original data) Elite Audit 7.02.26/Rhvac 8.01.151 Energy-10 v1-7 EnergyGauge USA 2.42 EnergyPlus v1-3 MICROPAS REMRate v 6.01 Right-Suite Residential v12.11 TREAT 3.0.19 VisualDOE 4.1.2								Additional Comments	
	Wall	Floor	Wall	Wall	Wall									
window front wall assignment	GW 1 (the only wall)	GW 1 (the only wall)	GW 1 (the only wall)	GW 1 (the only wall)	x							x		x
window front storm window	no	no	no	no										
window front shaded type	double-vinyl low-e	double-vinyl low-e	double-vinyl low-e	double-vinyl low-e	x		x	x				x	x	x
window front shaded area (sqft)	25 (2 x 2650)	25 (2 x 2650)	25 (2 x 2650)	25 (2 x 2650)	x	x	x	x				x	x	x
window front shaded orientation	east	east	east	east	x	x	x	x				x	x	x
window front shaded u-value	0.46	0.46	0.46	0.46	x	x	x	x				x	x	x
window front shaded shgc	0.57	0.57	0.57	0.57	x	x	x	x				x		x
window front shaded overhang depth (ft)	5	5	5	5	x	x	x	x				x		
window front shaded overhang to top of window (ft)	1.3	1.3	1.3	1.3	x	x	x	x				x		
window front shaded overhang to bottom of window (ft)	6.3	6.3	6.3	6.3	x							x		
window front shaded overhang int shad winter	1	1	1	1	x							x		
window front shaded overhang int shad summer	1	1	1	1	x							x		
window front shaded overhang adj shad winter	none	none	none	none	x							x		
window front shaded overhang adj shad summer	none	none	none	none	x							x		
window front shaded wall assignment	GW 1 (the only wall)	GW 1 (the only wall)	GW 1 (the only wall)	GW 1 (the only wall)	x							x		x
window front shaded storm window	no	no	no	no										
window left type	double-vinyl low-e	double-vinyl low-e	double-vinyl low-e	double-vinyl low-e	x		x	x				x	x	x
window left area (sqft)	25 (2 x 2650)	25 (2 x 2650)	25 (2 x 2650)	25 (2 x 2650)	x	x	x	x				x	x	x
window left orientation	north	north	north	north	x	x	x	x				x	x	x
window left u-value	0.46	0.46	0.46	0.46	x	x	x	x				x	x	x
window left shgc	0.57	0.57	0.57	0.57	x	x	x	x				x		x
window left overhang depth (ft)	0	0	0	0	x	x	x	x				x		
window left overhang to top of window (ft)	0	0	0	0	x	x	x	x				x		
window left overhang to bottom of window (ft)	0	0	0	0	x							x		
window left overhang int shad winter	1	1	1	1	x							x		
window left overhang int shad summer	1	1	1	1	x							x		
window left overhang adj shad winter	none	none	none	none	x							x		
window left overhang adj shad summer	none	none	none	none	x							x		
window left wall assignment	GW 1 (the only wall)	GW 1 (the only wall)	GW 1 (the only wall)	GW 1 (the only wall)	x							x		x
window left storm window	no	no	no	no										
window back type	double-vinyl low-e	double-vinyl low-e	double-vinyl low-e	double-vinyl low-e	x		x	x				x	x	x
window back area (sqft)	18.5 (2850, 262.5)	18.5 (2850, 262.5)	18.5 (2850, 262.5)	18.5 (2850, 262.5)	x	x	x	x				x	x	x
window back orientation	west	west	west	west	x	x	x	x				x	x	x
window back u-value	0.46	0.46	0.46	0.46	x	x	x	x				x	x	x
window back shgc	0.57	0.57	0.57	0.57	x	x	x	x				x		x
window back overhang depth (ft)	0	0	0	0	x	x	x	x				x		
window back overhang to top of window (ft)	0	0	0	0	x	x	x	x				x		
window back overhang to bottom of window (ft)	0	0	0	0	x							x		
window back overhang int shad winter	1	1	1	1	x							x		
window back overhang int shad summer	1	1	1	1	x							x		
window back overhang adj shad winter	none	none	none	none	x							x		
window back overhang adj shad summer	none	none	none	none	x							x		
window back wall assignment	GW 1 (the only wall)	GW 1 (the only wall)	GW 1 (the only wall)	GW 1 (the only wall)	x							x		x
window back storm window	no	no	no	no										
window right type	double-vinyl low-e	double-vinyl low-e	double-vinyl low-e	double-vinyl low-e	x		x	x				x	x	x
window right area (sqft)	7.5 (2630)	7.5 (2630)	7.5 (2630)	7.5 (2630)	x	x	x	x				x	x	x
window right orientation	south	south	south	south	x	x	x	x				x	x	x
window right u-value	0.46	0.46	0.46	0.46	x	x	x	x				x	x	x
window right shgc	0.57	0.57	0.57	0.57	x	x	x	x				x		x
window right overhang depth (ft)	0	0	0	0	x	x	x	x				x		

Closed Crawl Space Performance: Proof of Concept in the Production Builder Market Place
Instrument No. DE-FC26-04NT42319

Input	Conditioned Crawl - Wall	Unvented Crawl - Floor	Unvented Crawl - Wall	Vented Crawl	REMI/Rate v 11.41 (original data)	Elite Audit 7.02.26/Rhvac 8.01.151	Energy-10 v1-7	EnergyGauge USA 2.42	EnergyPlus v1-3	MICROPAS 6.01	REMI/Rate v 12.11	Right-Suite Residential 6.0.27	TREAT 3.0.19	VisualDOE 4.1.2	Additional Comments
window right overhang to top of window (ft)	0	0	0	0	x	x	x	x			x				
window right overhang to bottom of window (ft)	0	0	0	0	x						x				
window right overhang int shad winter	1	1	1	1	x						x				
window right overhang int shad summer	1	1	1	1	x						x				
window right overhang adj shad winter	none	none	none	none	x						x				
window right overhang adj shad summer	none	none	none	none	x						x				
window right wall assignment	GW 1 (the only wall)	GW 1 (the only wall)	GW 1 (the only wall)	GW 1 (the only wall)	x						x		x		
window right storm window	no	no	no	no				x							
window shades in the summer	no	no	no	no										x	
Doors															
door front type	steel-urth w/brk	steel-urth w/brk	steel-urth w/brk	steel-urth w/brk	x			x			x	x			
door front area (sqft)	20 (3068)	20 (3068)	20 (3068)	20 (3068)	x	x	x	x			x		x		
door front r-val	4.4	4.4	4.4	4.4	x			x			x		D		
door front u-val	0.227	0.227	0.227	0.227		x	x	x				D			
door front storm door	no	no	no	no	x			x			x		x		
door front wall assignment	GW 1 (the only wall)	GW 1 (the only wall)	GW 1 (the only wall)	GW 1 (the only wall)	x						x				
door front exposure direction	east	east	east	east		x	x	x					x		
door back type	steel-urth w/brk	steel-urth w/brk	steel-urth w/brk	steel-urth w/brk	x			x			x				
door back area (sqft)	14 (3048-window)	14 (3048-window)	14 (3048-window)	14 (3048-window)	x	x	x	x			x		x		
door back r-val	4.4	4.4	4.4	4.4	x			x			x		x		
door back u-val	0.227	0.227	0.227	0.227		x	x	x							
door back storm door	no	no	no	no	x						x		x		
door back wall assignment	GW 1 (the only wall)	GW 1 (the only wall)	GW 1 (the only wall)	GW 1 (the only wall)	x						x		x		
door back exposure direction	west	west	west	west		x	x	x						x	
Ceiling/Attic/Roof															
ceiling type	r-30 blown attic	r-30 blown attic	r-30 blown attic	r-30 blown attic	x	x					x	x		x	
ceiling type	attic (full)	attic (full)	attic (full)	attic (full)	x			x			x	x	x		
ceiling u-val	0.033	0.033	0.033	0.033	x	x					x	x		x	
ceiling area (sqft)	1040	1040	1040	1040	x	x	x	x			x		x		
attic elevation	10.5	10.5	10.5	10.5										x	
ceiling input mode	quick fill site-built	quick fill site-built	quick fill site-built	quick fill site-built	x						x				
ceiling gypsum thickness (in)	0.625	0.625	0.625	0.625	x						x		x		
ceiling bottom chord/rafter size (w x h, in)	1.5 x 3.5	1.5 x 3.5	1.5 x 3.5	1.5 x 3.5	x						x		x		
ceiling bottom chord/rafter spacing (in oc)	24	24	24	24	x						x		x		
ceiling framing factor	0.11 (default)	0.11 (default)	0.11 (default)	0.11 (default)	x			x	x		x				
ceiling cont ins r-val	17	17	17	17	x		x				x		x		
ceiling cavity ins r-val	13	13	13	13	x		x	x			x		x		
ceiling cavity ins thickness (in)	3.5	3.5	3.5	3.5	x						x		x		
ceiling radiant barrier	no	no	no	no	x				x		x		x		
attic height (avg)	4	4	4	4										x	
roof configuration	gable or shed	gable or shed	gable or shed	gable or shed					x						
roof pitch	5/12	5/12	5/12	5/12				x							
roofing material	composition shingles	composition shingles	composition shingles	composition shingles		x		x				x			
ceiling ext color (treat absorptivity)	medium (0.75)	medium (0.75)	medium (0.75)	medium (0.75)	x			x	x		x	x	x	x	
outside emissivity	0.9	0.9	0.9	0.9											x
attic conditioned	no	no	no	no										x	
attic natural ventilation	yes	yes	yes	yes							x		x		
attic ventilation ratio	0.0033	0.0033	0.0033	0.0033				x							
attic occupied hrs/day	0	0	0	0										x	
attic persons	0	0	0	0										x	

Closed Crawl Space Performance: Proof of Concept in the Production Builder Market Place
Instrument No. DE-FC26-04NT42319

Input	Conditioned Crawl - Wall	Unvented Crawl - Floor	Unvented Crawl - Wall	Vented Crawl	REHMRate v 11.41 (original data)	Elite Audit 7.02.26/RHVac 8.01.151	Energy-10 v1-7	EnergyGauge USA 2.42	EnergyPlus v1-3	MICROPAS 6.01	REHMRate v 12.11	Right-Suite Residential 6.0.27	TREAT 3.0.19	VisualDOE 4.1.2	Additional Comments
Heat Pump															
heat pump type	air-source	air-source	air-source	air-source	x	x				x	x	x			
heat pump fuel	electric	electric	electric	electric							x	x			
heat pump location	ncnd bsmnt/enc crwl	ncnd bsmnt/enc crwl	ncnd bsmnt/enc crwl	ncnd bsmnt/enc crwl	x		x			x	x	x			
heat pump performance adj %	100	100	100	100	x					x	x	x			
heat pump number of units	1	1	1	1	x					x	x	x			
heat pump load served heating	100	100	100	100	x					x	x	x			
heat pump load served cooling	100	100	100	100	x					x	x	x			
heat pump load served DHW	0	0	0	0	x					x					
heat pump heating HSPF	6.8	6.8	6.8	6.8	x		x			x	x	x			
heat pump heating compressor capacity at 47F (kBtuh)	24	24	24	24	x		x	x		x	x	x			
heat pump heating electric resistance backup capacity (kW)	0	0	0	0	x					x				x	
heating system year	2002	2002	2002	2002								x			
cooling system year	2002	2002	2002	2002								x			
heating design supply temperature	130	130	130	130			x				x	x			
forced air distribution furnace heating temp drop F	50	50	50	50								x			
forced air distribution heat pump heating temp drop F	30	30	30	30								x			
leaving coil-room delta T winter	130	130	130	130		x									
leaving coil-room delta T summer	-55	-55	-55	-55		x									
electric distribution baseboard capacity watt/ft	250	250	250	250										x	
hydronic distribution boiler heating temperature drop F	20	20	20	20										x	
hydronic distribution baseboard capacity btu/hr/ft	575	575	575	575										x	
safety factors heating safety factor %	10	10	10	10										x	
target heating energy usage Btu/SqFt-HDD	4	4	4	4										x	
heat pump cooling SEER	10	10	10	10	x		x	x		x	x	x			
heat pump cooling capacity (kBtuh)	24	24	24	24	x			x		x	x	x			
heat pump cooling sensible heat fraction (SHF)	0.7	0.7	0.7	0.7	x		x	x		x	x				
cooling design supply temperature	55	55	55	55			x							x	
cooling latent load %	25	25	25	25										x	
forced air distribution cooling temp drop F	28	28	28	28										x	
safety factors cooling safety factor %	10	10	10	10										x	
heat pump desuperheater	no	no	no	no	x					x					
account for part load system efficiency	no	no	no	no										x	
safety factors distribution safety factor %	10	10	10	10										x	
oversize limit for system sizing (???)	1	1	1	1				x							
heat pump coefficient of performance (COP)	1.991798477	1.991798477	1.991798477	1.991798477			x								
heat pump Shut-off Temperature	40	40	40	40											
Supplemental Heat on temperature	40	40	40	40											
defrost type	electric resistance	electric resistance	electric resistance	electric resistance								x			
defrost control	timed	timed	timed	timed											
defrost temperature	40	40	40	40											
compressor type	single speed	single speed	single speed	single speed											
heat pump cop at 47F				3											
heat pump capacity at 47F				24000											
heat pump cop at 17F				2										2.1?	
heat pump capacity at 17F				13000										12000?	
electrical resistance, btu/h				60090?											
percent sensible capacity	75 (default)	75 (default)	75 (default)	75 (default)			x								
heating sensible effectiveness (rightsuite default)	60	60	60	60							x				
cooling sensible effectiveness (rightsuite default)	60	60	60	60							x				

Closed Crawl Space Performance: Proof of Concept in the Production Builder Market Place
Instrument No. DE-FC26-04NT42319

Input	Conditioned Crawl - Unvented Crawl - Unvented Crawl - Vented Crawl				<div style="display: flex; justify-content: space-around; font-size: small;"> REMI/Rate v 11.41 (original data) Elite Audit 7.02.26/Rhvac 8.01.151 Energy-10 v1-7 EnergyGauge USA 2.42 EnergyPlus v1-3 MICROPAS v1-3 REMI/Rate v 6.01 Right-Suite Residential v12.11 TREAT 3.0.19 VisualDOE 4.1.2 </div>								Additional Comments			
	Wall	Floor	Wall	Wall	REMI/Rate v 11.41 (original data)	Elite Audit 7.02.26/Rhvac 8.01.151	Energy-10 v1-7	EnergyGauge USA 2.42	EnergyPlus v1-3	MICROPAS v1-3	REMI/Rate v 6.01	Right-Suite Residential v12.11		TREAT 3.0.19	VisualDOE 4.1.2	
heating correction	0.77	0.77	0.77	0.77											x	
cooling correction	1	1	1	1											x	
heating Btuh 17F	13392	13392	13392	13392											x	
heating COP 17F	1.87	1.87	1.87	1.87											x	
heating Btuh 35F	17782	17782	17782	17782											x	
heating COP 35F	2.32	2.32	2.32	2.32											x	
heating Btuh 47F	24000	24000	24000	24000											x	
heating COP 47F	3	3	3	3											x	
heating fan cfm	432	432	432	432											x	
heating fan W	175	175	175	175											x	
cooling Btuh 82F	24000	24000	24000	24000											x	
cooling SEER 82F	10.9	10.9	10.9	10.9											x	
cooling Btuh 95F	22852	22852	22852	22852											x	
cooling SEER 95F	9.8	9.8	9.8	9.8											x	
cooling fan cfm	432	432	432	432											x	
cooling fan W	175	175	175	175											x	
cont fan cfm	0	0	0	0											x	
cont fan W	0	0	0	0											x	
Hot Water																
hot water location	cond area	cond area	cond area	cond area	x		x			x					x	
hot water number of units	1	1	1	1	x		x			x					x	
hot water performance adj %	100	100	100	100	x					x						
hot water load served heating	0	0	0	0	x					x						
hot water load served cooling	0	0	0	0	x					x						
hot water load served DHW	100	100	100	100	x					x						
hot water type	conventional	conventional	conventional	conventional	x					x	x					
hot water fuel type	electric	electric	electric	electric	x		x			x	x	x			x	
hot water energy factor	0.88	0.88	0.88	0.88	x		x			x	x	x				
hot water recovery efficiency	0.98	0.98	0.98	0.98	x					x	x	x				
hot water water tank size (gallons)	50	50	50	50	x		x			x	x	x				
hot water extra tank insulation r-val	0	0	0	0	x		x			x					x	
hot water input, btu/hr, per heater															x	x
input (kVWh)	4.5	4.5	4.5	4.5								x				
entering cold water temperature	62	62	62	62								x	x			
hot water heater year	2002	2002	2002	2002											x	
hot water pipe insulation	0	0	0	0								x	x			
hot water pipe area, sqft	8	8	8	8								x	x			
hot water pipe recirculating system	no	no	no	no											x	
hot water pipe % running through each space	100% living	100% living	100% living	100% living											x	
hot water demand usage adjustment multiplier	1	1	1	1											x	
hot water demand dishes washed by hand	no	no	no	no											x	
hot water EIR	1.02	1.02	1.02	1.02												x
hot water peak consumption	1	1	1	1												x
hot water supply temperature	110	110	110	110								x				x
water temp	180	180	180	180								x				
how water tank loss	0.03	0.03	0.03	0.03												x
gal/person	15	15	15	15												
daily use gpd	68	68	68	68								x				
hot water piping	1.0" copper	1.0" copper	1.0" copper	1.0" copper												
exposed length	30.5	30.5	30.5	30.5												

Closed Crawl Space Performance: Proof of Concept in the Production Builder Market Place
Instrument No. DE-FC26-04NT42319

Input	Conditioned Crawl - Unvented Crawl - Unvented Crawl - Vented Crawl				REMRate v 11.41 (original data) Elite Audit 7.02.26/Rhvac 8.01.151 Energy-10 v1-7 EnergyGauge USA 2.42 EnergyPlus v1-3 MICROPAS 6.01 REMRate v 12.11 Right-Suite Residential 6.0.27 TREAT 3.0.19 VisualDOE 4.1.2								Additional Comments				
	Wall	Floor	Wall	Wall	Wall												
infiltration characteristic EqLA		86.5	71.8	77.3				x									
infiltration characteristic ACH		0.289	0.239	0.28				x									
infiltration characteristic ACH(50)		6.04	5.01	5.4				x									
infiltration characteristic SLA		0.00031	0.00025	0.00027				x									
infiltration characteristic Min SLA		0.000372	0.000372	0.000372				x									
leakage area (in2)		67	56	60													
mechanical ventilation for IAQ type	supply only	supply only	supply only	supply only	x						x						11
mechanical ventilation for IAQ sensible recov eff %	0	0	0	0	x						x						
mechanical ventilation for IAQ total recov eff %	0	0	0	0	x						x						
mechanical ventilation for IAQ rate (cfm)	40	40	40	40	x	x					x						
mechanical ventilation for IAQ hours/day	24	24	24	24	x						x						
mechanical ventilation for IAQ fan watts	0	0	0	0	x						x						
ventilation strategy for cooling	natural ventilation	natural ventilation	natural ventilation	natural ventilation	x						x						x
Base Load																	
lights and appliances oven/range fuel	electric	electric	electric	electric	x			x			x						
lights and appliances clothes dryer fuel	electric	electric	electric	electric	x			x			x						
lights and appliances load	default	default	default	default	x						x						
appliance schedule	IECC std. design	IECC std. design	IECC std. design	IECC std. design				x									
average lighting load Wh/SqFt-Day	3	3	3	3													x
HERS index lighting schedule	yes	yes	yes	yes							x						
ceiling fan cfm/watt	0 (no fan)	0 (no fan)	0 (no fan)	0 (no fan)				x			x						
number of refrigerators	1	1	1	1				x									
refrigerator kwh/yr	775	775	775	775							x						
dishwasher EF	0.46	0.46	0.46	0.46							x						
% fluorescent bulbs	10	10	10	10				x			x						
pool pump	none	none	none	none				x									
well pump	none	none	none	none				x									
photovoltaics	none	none	none	none	x			x			x						
people loads sensible	230	230	230	230				x									
people loads latent	200	200	200	200				x									
lighting (kWh/yr)	1287																
appliances																	
dishwasher	yes	yes	yes	yes													x
clothes washer	yes	yes	yes	yes													x
Weather																	
weather state	NC	NC	NC	NC	x	x	x							x	x		
weather city	Greenville	Greenville	Greenville	Greenville	x	x	x							x	D	D	
TMY site	NC_Raleigh	NC_Raleigh	NC_Raleigh	NC_Raleigh	x	x	x										
bin data city	ymour Johnson AFB	ymour Johnson AFB	ymour Johnson AFB	ymour Johnson AFB										x			
earth temperature city	new bern, nc	new bern, nc	new bern, nc	new bern, nc										x			
IECC Climate Zone	3A	3A	3A	3A							x						
CEC Climate Zone (01 thru 16)																	
ASHRAE W Factor	0.72	0.72	0.72	0.72							x						
HDD, base 65F	63 (3112 Greenville)	63 (3112 Greenville)	63 (3112 Greenville)	63 (3112 Greenville)	x			x			x						
CDH, base 74F	16040	16040	16040	16040	x						x						
CDD, base 65F	21 (1636 Greenville)	21 (1636 Greenville)	21 (1636 Greenville)	21 (1636 Greenville)													
CLH cooling load hours	1200	1200	1200	1200										x			
HLH heating load hours	1750	1750	1750	1750										x			
design site latitude	35.599	35.599	35.599	35.599	x			x						x			
design site longitude	77.374	77.374	77.374	77.374				x									

Closed Crawl Space Performance: Proof of Concept in the Production Builder Market Place
Instrument No. DE-FC26-04NT42319

Input	Conditioned Crawl - Unvented Crawl - Unvented Crawl - Vented Crawl				REMRate v 11.41 (original data) Elite Audit 7.02.26/Rhvac 8.01.151 Energy-10 v1-7 EnergyGauge USA 2.42 EnergyPlus v1-3 MICROPAS 6.01 REMRate v 12.11 Right-Suite Residential 6.0.27 TREAT 3.0.19 VisualDOE 4.1.2								Additional Comments
	Wall	Floor	Wall	Wall	Wall								
design site altitude	60	60	60	60	x	x					x		
site elevation	36	36	36	36	x						x		x
design site time zone	5	5	5	5			x						
design site avg. annual temp	61.7	61.7	61.7	61.7			x						
design site winter 97.5% design temp	21	21	21	21	x	x	x	x		D	x		
design site winter int. design temp	68	72	72	72			x						
design site winter heating degree days	3163	3163	3163	3163			x						
design site winter weather factor	0.94	0.94	0.94	0.94			x						
design site summer 2.5% design temp	91	91	91	91	x	x	x			x	x		
design site summer int design temp	75	75	75	75			x						
design site summer design moisture (gr)	50	50	50	50			x						
design site summer wet bulb temperature	76	76	76	76		x					x		
design site summer daily temp range	medium (19)	medium (19)	medium (19)	medium (19)		x	x				x		
account for climate impact on HSPF and SEER	yes	yes	yes	yes								x	
heating month threshold, hdd/month	50	50	50	50								x	
cooling month threshold, cdd/month	25	25	25	25								x	
shielding class (1-5, none to large obstructions in all dir)	4 (suburban)	4 (suburban)	4 (suburban)	4 (suburban)			x	x			x	x	
detailed surroundings	no	no	no	no				x					
terrain parameter (wind speed)	suburban	suburban	suburban	suburban				x					
heating wind speed	15	15	15	15									
cooling wind speed	7.5	7.5	7.5	7.5									
wind correction factor (fraction)	0	0	0	0					x				
shadow pattern simulator file name	0.0	0.0	0.0	0.0						x			
weather data type	FullYear	FullYear	FullYear	FullYear							x		
elevation derating sensible	1	1	1	1		x							
elevation derating total	1	1	1	1			x						
elevation derating heating	1	1	1	1			x						
day of minimum earth surface temperature	35	35	35	35							x		
Fuel													
fuel company	Progress	Progress	Progress	Progress	x	x	x				x	x	x
fuel rate	0.08054/0.09054	0.08054/0.09054	0.08054/0.09054	0.08054/0.09054	x	x	D	D			x	D	D
fuel rate months	nov to jun/jul to oct	nov to jun/jul to oct	nov to jun/jul to oct	nov to jun/jul to oct	x	x					x		
multiple fuel rates?	yes	yes	yes	yes									
fuel monthly flat fee	6.75	6.75	6.75	6.75	x						x	x	
fuel type	electric	electric	electric	electric	x		x	x			x	x	
heating season	jan to dec	jan to dec	jan to dec	jan to dec				x				x	
cooling season	jan to dec	jan to dec	jan to dec	jan to dec				x				x	
metered spaces	no input	no input	no input	no input								x	
utility bills	no input	no input	no input	no input								x	
Algorithms													
energy model calculation	r-value + heat cap...	r-value + heat cap...	r-value + heat cap...	r-value + heat cap...								x	
infiltration algorithm	fixed infiltration rate	fixed infiltration rate	fixed infiltration rate	fixed infiltration rate								x	
savings term, years (target payback, project life cycle)	10	10	10	10								x	x
discount rate	10% (default)	10% (default)	10% (default)	10% (default)									x
advanced billing data input	off	off	off	off								x	
analysis periods	no input	no input	no input	no input								x	
compliance run	Research	Research	Research	Research							x		
standard assumptions	Reference	Reference	Reference	Reference							x		
time of use schedule name	0.0	0.0	0.0	0.0							x		
holiday set	Official US	Official US	Official US	Official US									x

Closed Crawl Space Performance: Proof of Concept in the Production Builder Market Place
Instrument No. DE-FC26-04NT42319

Input	Conditioned Crawl -		Unvented Crawl -		Vented Crawl	<div style="display: flex; justify-content: space-between;"> REMI/Rate v 11.41 (original data) Elite Audit 7.02.26/Rhvac 8.01.151 </div>								Additional Comments		
	Wall	Floor	Wall	Floor		REMI/Rate v 11.41 (original data)	Elite Audit 7.02.26/Rhvac 8.01.151	Energy-10 v1-7	EnergyGauge USA 2.42	EnergyPlus v1-3	MICROPAS v1-3	REMI/Rate v 12.11	Right-Suite Residential 6.0.27		TREAT 3.0.19	VisualDOE 4.1.2
crawl space LPD W/ft2	0	0	0	0	0											x
crawl space LPD Watt	0	0	0	0	0											x
crawl space Light to Space	1	1	1	1	1											x
crawl space EPD W/ft2	0.75	0.75	0.75	0.75	0.75											x
crawl space EPD Watt	900	900	900	900	900											x
crawl space Occ Density ft2/Person	100000	100000	100000	100000	100000											x
crawl space Occ Density people	0.012	0.012	0.012	0.012	0.012											x
crawl space Zone Type	Unconditioned	Unconditioned	Unconditioned	Unconditioned	Unconditioned											x
crawl space Occupancy	Office	Office	Office	Office	Office											x
crawl space Infiltration ACH	0.3	0.3	0.3	0.3	2											x
crawl space Skylight	no	no	no	no	no											x
crawl space Dalight Control	None	None	None	None	None											x
crawl space Open to Below	n/a	n/a	n/a	n/a	n/a											x
main floor LPD W/ft2	2.4	2.4	2.4	2.4	2.4											x
main floor LPD Watt	2880	2880	2880	2880	2880											x
main floor Light to Space	1	1	1	1	1											x
main floor EPD W/ft2	0.25	0.25	0.25	0.25	0.25											x
main floor EPD Watt	300	300	300	300	300											x
main floor Occ Density ft2/Person	300	300	300	300	300											x
main floor Occ Density people	4	4	4	4	4											x
main floor Zone Type	Conditioned	Conditioned	Conditioned	Conditioned	Conditioned											x
main floor Occupancy	Hotel	Hotel	Hotel	Hotel	Hotel											x
main floor Infiltration ACH	0.2	0.2	0.2	0.2	0.28											x
main floor Skylight	no	no	no	no	no											x
main floor Dalight Control	None	None	None	None	None											x
main floor Open to Below	no	no	no	no	no											x
Additional Space/Mass																
attached garage	no	no	no	no	no											x
sunspace	no	no	no	no	no	x										x
added mass	no	no	no	no	no											x
fraction of floor space with furniture	0.3	0.3	0.3	0.3	0.3											x

REMRate v 11.41 (original data)	
Elite Audit 7.02.26/Rhvac 8.01.151	
Energy-10 v1-7	
EnergyGauge USA 2.42	
EnergyPlus v1-3	
MICROPAS 6.01	
REMRate v 12.11	
Right-Suite Residential 6.0.27	
TREAT 3.0.19	
VisualDOE 4.1.2	
	Additional Comments

Comment Summary:

- 1 Treat vented crawl = unheated high ACH, closed crawl = unheated low ACH
- 2 treat 8"
- 3 Treat doesn't have exact parameters
- 4 Treat "elevation ft"
- 5 Treat requires >=0.1
- 6 Treat doesn't have exact parameters
- 7 Treat adds cont insulation from 1" wood sheathing, but can't customize
- 8 Treat cannot customize
- 9 Treat doesn't exactly have the criteria
- 10 Treat model roof as unheated high ACH
- 11 Treat has no option for this
- 12 Treat must use Raleigh
- 13 Treat uses 0.08554
- 14 EnergyGauge uses 0.08554
- 15 REM 12 uses 26 for this value
- 16 VisualDOE must use Raleigh
- 17 VisualDOE uses 0.08554
- 18 VisualDOE can't input the window sizes
- 20 Energy10 must use Raleigh
- 21 Energy10 uses 0.08554
- 22 Audit can use Greenville for CDH/HDD, but Raleigh used for BIN calculation
- 23 Rightsuite must use 0.47 u-value
- 24 Rightsuite must use 0.290 u-value
- 25 Rightsuite automatically adjust return and supply duct area

Input Totals:

208 105 91 150 0 9 214 128 182 89

