

Hydronic Heating Retrofits for Low-Rise Multifamily Buildings: Boiler Control Replacement and Monitoring

Jordan Dentz, Hugh Henderson, and
Kapil Varshney
ARIES Collaborative

October 2013

NOTICE

This report was prepared as an account of work sponsored by an agency of the United States government. Neither the United States government nor any agency thereof, nor any of their employees, subcontractors, or affiliated partners makes any warranty, express or implied, or assumes any legal liability or responsibility for the accuracy, completeness, or usefulness of any information, apparatus, product, or process disclosed, or represents that its use would not infringe privately owned rights. Reference herein to any specific commercial product, process, or service by trade name, trademark, manufacturer, or otherwise does not necessarily constitute or imply its endorsement, recommendation, or favoring by the United States government or any agency thereof. The views and opinions of authors expressed herein do not necessarily state or reflect those of the United States government or any agency thereof.

Available electronically at <http://www.osti.gov/bridge>

Available for a processing fee to U.S. Department of Energy
and its contractors, in paper, from:

U.S. Department of Energy
Office of Scientific and Technical Information
P.O. Box 62
Oak Ridge, TN 37831-0062
phone: 865.576.8401
fax: 865.576.5728
email: <mailto:reports@adonis.osti.gov>

Available for sale to the public, in paper, from:

U.S. Department of Commerce
National Technical Information Service
5285 Port Royal Road
Springfield, VA 22161
phone: 800.553.6847
fax: 703.605.6900
email: orders@ntis.fedworld.gov
online ordering: <http://www.ntis.gov/ordering.htm>



Hydronic Heating Retrofits for Low-Rise Multifamily Buildings: Boiler Control Replacement and Monitoring

Prepared for:

The National Renewable Energy Laboratory

On behalf of the U.S. Department of Energy's Building America Program

Office of Energy Efficiency and Renewable Energy

15013 Denver West Parkway

Golden, CO 80401

NREL Contract No. DE-AC36-08GO28308

Prepared by:

Jordan Dentz, Hugh Henderson, and Kapil Varshney

ARIES Collaborative

The Levy Partnership, Inc., 1776 Broadway, Suite 2205

New York, NY 10019

NREL Technical Monitor: Michael Gestwick

Prepared Under Subcontract No. KNDJ-0-40347-02

October 2013

[This page left blank]

Contents

List of Figures	vi
List of Tables	vii
Definitions.....	viii
Acknowledgments	ix
Executive Summary	x
1 Introduction.....	1
2 Relevance to Building America’s Goals.....	2
3 Site Description	3
4 Retrofit Strategies and Monitoring Plan.....	7
4.1 Building 3.....	8
4.2 Building 4.....	11
4.3 Building 55.....	12
4.4 Data Collection	13
4.5 Equipment.....	15
5 Methodology	17
6 Results and Analysis	18
6.1 Building 3.....	18
6.2 Building 4.....	20
6.2.1 Outdoor Reset	21
6.2.2 Nighttime Setback.....	23
6.3 Building 55.....	24
6.3.1 Boiler Runtime and Gas Use Correlation	25
6.3.2 Nighttime Setback.....	27
6.4 Utility Bill Analysis	30
6.5 Cost Effectiveness.....	34
6.6 Other Impacts.....	35
7 Conclusions	36
8 Future Work.....	37
9 References	39

List of Figures

Figure 1. Exterior view of Building 4 and typical basement boiler room	3
Figure 2. Pre-existing boiler controllers (a, b) and local radiator controller (c, d).....	4
Figure 3. Approximate previously existing boiler reset schedules	5
Figure 4. Aerial photo showing divisions of buildings and number of units	5
Figure 5. Typical space heating system diagram	6
Figure 6. Controller Web interface	9
Figure 7. Mixing valve controller (top) and boiler controller (bottom) set points and system temperatures	10
Figure 8. Sample apartment temperature sensor data.....	10
Figure 9. Building 3 system configuration	11
Figure 10. Building 4 system configuration	12
Figure 11. Building 55 system configuration	13
Figure 12. Building 3 system temperature versus outdoor temperature	19
Figure 13. Building 3 system temperature versus average indoor temperature.....	20
Figure 14. Building 4 boiler performance October 20, 2011	21
Figure 15. Boiler loading, Building 4.....	22
Figure 16. Gas use, Building 4.....	22
Figure 17. System temperatures and boiler loading March 27, 2012, Building 4.....	23
Figure 18. No impact of nighttime setback, Building 4	24
Figure 19. Boiler supply target and outdoor temperature in Building 55	25
Figure 20. Plot of actual and predicted gas use	26
Figure 21. Plot of monthly gas use, Building 55.....	27
Figure 22. Plot of boiler loading—comparing days with and without setback through March 6	28
Figure 23. Operating temperatures in Building 55 before night setback	29
Figure 24. Operating temperatures in Building 55 with night setback.....	29
Figure 25. Building 3 dependence of energy consumption on OAT (diamonds and green line = post-retrofit; squares and brown line = pre-retrofit).....	30
Figure 26. Building 4 dependence of energy consumption on OAT (diamonds and green line = post-retrofit; squares and brown line = pre-retrofit).....	30
Figure 27. Building 55 dependence of energy consumption on OAT (diamonds and green line = post-retrofit; squares and brown line = pre-retrofit).....	31
Figure 28. Wegowise gas use graph for 3 Columbia Terrace.....	32
Figure 29. Wegowise gas use graph for 4 Columbia Terrace.....	33
Figure 30. Wegowise gas use graph for 55 Columbia Street	33
Figure 31. Diagram of local zone control scheme for Building 55.....	38

Unless otherwise indicated, all figures were created by ARIES.

List of Tables

Table 1. Existing and Planned Retrofit Controllers	7
Table 2. Pre- and Post-Retrofit Boiler Controller Settings.....	8
Table 3. Summary of Monitoring Data Points in Building 3.....	14
Table 4. Summary of Monitoring Data Points in Building 4.....	15
Table 5. Summary of Monitoring Data Points in Building 55.....	15
Table 6. Materials and Equipment.....	16
Table 7. Data Collection Periods for Each Building	18
Table 8. Actual and Predicted Gas Use by Utility Billing Period.....	26
Table 9. Dependence of Energy Consumption on OAT (Slope) and Coefficient of Determination (R ²).....	31
Table 10. Pre- and Post-Retrofit Heating and Total Energy Consumption and Reduction (therms).....	32
Table 11. Energy and Cost Savings Calculations for Heating Season 2011–2012.....	34

Unless otherwise indicated, all tables were created by ARIES.

Definitions

ARIES	Advanced Residential Integrated Energy Solutions Building America team
CAST	Cambridge Alliance for Spanish Tenants
DHW	Domestic hot water
F	Fahrenheit
HRI	Homeowners' Rehab, Inc.
OAT	Outdoor air temperature
TRV	Thermostatic radiator valve
WWSD	Warm weather shutdown

Acknowledgments

The Advanced Residential Integrated Energy Solutions (ARIES) Collaborative would like to recognize the support of the U.S. Department of Energy’s Building America Program and Michael Gestwick of the National Renewable Energy Laboratory for technical guidance. This project would not have been possible without the support and participation on Jane Carbone and Beverly Craig of Homeowners’ Rehab Inc. (HRI), Cambridge, Massachusetts; Martha Abrams and Ivan Leslie of Abrams Management, Boston, Massachusetts; and Kevin Reid of Boston Cooling and Heating, Norwood, Massachusetts. Thanks are also due to Andrew Proulx, EnerSpectives, Inc., Concord, Massachusetts, Victor Zelmanovich, Intech 21, Port Washington, New York, and Michael Keber, Tekmar Controls, Vernon, British Columbia.

Executive Summary

The ARIES Collaborative, a U.S. Department of Energy Building America research team, partnered with NeighborWorks America affiliate HRI of Cambridge, Massachusetts, to implement and study improvements to the central hydronic heating systems in one of the nonprofit's housing developments. The heating control systems in the three-building, 42-unit Columbia Cambridge Alliance for Spanish Tenants (CAST) housing development were upgraded in an effort projected to reduce heating costs 15%–25%.

HRI recognized that heating fuel use per square foot per heating degree day in the development was excessive compared to its other properties of similar construction. Although a poorly insulated thermal envelope contributes to high energy bills, adding insulation to the exterior walls is not a cost-effective or practical option for Columbia CAST, given the desire to maintain the building's historic exterior. Adding insulation on the interiors of exterior walls was also impractical, as it would disrupt the residents. The more cost-effective and readily available option was improving heating system efficiency.

Efficient operation of the heating system faced several obstacles, including inflexible boiler controls, failed thermostatic radiator valves, and disregard by residents of recommended thermostat set points. Boiler controls in three buildings were replaced with systems that offer temperature setbacks and one that controls heat delivery based on apartment temperatures in addition to outdoor temperatures. A utility bill analysis shows that after implementing control techniques overall weather-normalized energy consumption for heating was reduced by 10.1%–18.3% and the average savings was 15.2%.

This report summarizes the status of the project at the conclusion of the 2011–2012 heating season. During this first season various control settings and system configurations were altered as the systems were adjusted to maximize comfort and energy savings. The performance of the systems will be monitored during the 2012–2013 season and an updated final report will be prepared.

1 Introduction

Heating cost reductions can be achieved in several ways, including improving the boiler control strategy, giving the resident or building manager the ability to more precisely modulate the temperature according to need (instead of opening a window), and altering the distribution of heat in the building in ways that better reflect demand.

A number of older studies exist, documenting the benefits of outdoor reset control in multifamily buildings compared to the aquastat-controlled constant water temperatures (sometimes with controls that turn off the boiler when outdoor temperatures exceed a certain threshold) that typified the previous generation of multifamily heating systems (Hewett and Peterson 1984; Peterson 1986). Outdoor reset controls alone can improve the overall performance of the heating system, but they are very sensitive to commissioning. If the compensation curve is not adjusted properly, the overall heating energy consumption can be higher than that of a boiler controlled at a constant water temperature. Adding thermostatic radiator valves (TRVs) to radiators has been shown to reduce the system's dependence on commissioning, but under- or overheating at low loads can occur as TRVs age. Additionally, correct use of TRVs depends on proper use by the tenants (Liao and Dexter 2004). It has been shown that the overall performance of a heating system is highly dependent on the algorithm for determining the boiler temperature set point. Inferential models that, in the absence of real-time data, predict the average indoor temperature based on a simplified physical model, have been shown to be effective at increasing heating system efficiency (Liao and Dexter 2004; Liao and Dexter 2005). Now another shift in control strategies is underway, one based on measured real-time average indoor temperatures in combination with outdoor temperatures (Center for Energy and the Environment 2006; CNT Energy 2010; Gifford 2004).

New wireless technologies are available to cost-effectively monitor indoor space temperatures, centralize and automate thermostat set points, and, with the requisite level of control points in place, dynamically adjust heat distribution patterns. Control system manufacturers have produced case studies claiming benefits from outdoor reset boiler controls with indoor space temperature-based cutoffs of 25%–40% of heating fuel use. However, existing conditions and control algorithms are typically not well documented in these case studies. No known third-party, independent studies exist quantifying the effects of these improvements.

2 Relevance to Building America's Goals

There is a large stock of multifamily buildings in the Northeast and Midwest with space heating provided by centralized hot water or steam. According to the 2005 American Housing Survey, there are about 3.2 million occupied hydronically heated, low-rise multifamily housing units in the United States (U.S. Census Bureau 2006). Nearly 90% of these homes are in the Northeast or Midwest; with a large portion being rental units (40%) or occupied by the elderly (24%). Most hydronically heated homes are older, with only 1% being classified as new construction (built within the past four years) in the 2005 American Housing Survey data. Many of these housing units are candidates for improved boiler controls as described in this project. Vendors using established technologies are currently well suited to offer these systems on a widespread basis, should they prove to be cost effective and easily implemented.

Typically, residents of these buildings do not pay for heat directly (heat is not submetered). Losses from these systems are often higher than would be expected for buildings with centralized heat provided by a boiler serving multiple units (a significant number of apartments are overheated much of the time). Upgrades to these heating systems often include the installation of new, higher performance boilers, yet heating costs sometimes remain high because spaces are too warm and the thermal distribution systems are inefficient. The major underlying problems are: (1) outmoded and inefficient boiler control strategies, and (2) the inability to regulate the amount of heat provided at the point of use (the radiator).

Research is needed to establish optimum boiler control selection and operating strategies for older, multifamily buildings, verify the estimated savings associated with this technology, and characterize the factors that impact potential energy savings. Future work could include eQuest modeling to more broadly generalize the results.

No existing Building America guidelines address this topic. Three planned guideline documents to which this research might contribute are:

- Centralized Heating Systems In Multi-Family Buildings – for new homes
- HVAC Controls – for existing homes
- Hydronic Space Heating Improvements – for existing homes

In this project, the relative effectiveness of various control strategies to improve hydronic space heating performance in three low-rise multifamily buildings is evaluated. The research questions addressed are:

1. What are the energy savings and comfort benefits of retrofitting central boiler controllers using outdoor reset and indoor apartment temperature data into existing hydronically heated multifamily buildings?
2. How does a control system incorporating apartment temperature data compare in cost and performance with well-tuned outdoor reset strategies, including those that incorporate nighttime setback? This will be addressed by comparing the three buildings in the study.

The results of this work could be included in a future measures guidelines on hydronic heating system retrofits for multifamily buildings.

3 Site Description

Homeowners' Rehab Inc.'s (HRI) Columbia Cambridge Alliance for Spanish Tenants (CAST) housing development is a 42-unit complex of three, three-story masonry buildings in Cambridge, Massachusetts (Figure 1). Gas, which is used for space heating, water heating, cooking, and in one building for laundry, accounts for about 80% of the annual property energy expenditures. Each apartment is metered for electricity directly by the utility, so individual apartment electricity use is not available.



Figure 1. Exterior view of Building 4 and typical basement boiler room

Gas use in the buildings is higher than in other buildings in the area owned by HRI. Gas use for space heating alone is more than 0.6 therms/ft²/yr (more than 0.8 therms/ft²/yr overall).¹ Other HRI buildings with gas heat use 0.36–0.65 therms/yr overall. While a poorly insulated thermal envelope contributes to the problem, insulating the masonry walls from the exterior is not an option because of cost and historic preservation restrictions. Insulating the walls on the interior is also not an option because of the cost and disruption created by interior construction work. Other envelope efficiency measures may be considered in the future, but are unlikely to solve the heating distribution problem.

The buildings are heated with multiple boilers and controllers that reset supply water temperature based on outdoor temperature (Figure 2). The building operators are obligated under local ordinance to maintain a minimum space temperature in each apartment of 68°F during the day and 64°F at night (Massachusetts Department of Public Health, 2012). Each apartment has one or two nonelectric actuator zone valve controllers to regulate water flow through the baseboard heaters (Figure 2 (c) and (d)). These valves, when functional (many are failed), allow the resident

¹ Analysis of the building by Wegowise.com indicates that prior to the retrofit their heating consumption was 11–12 Btu/ft²/heating degree day, rating as “poor,” with 4–5 considered “great” and 8 considered “good.”

some control over heating and are marked with temperatures, although their calibration is unknown.



(a)



(b)

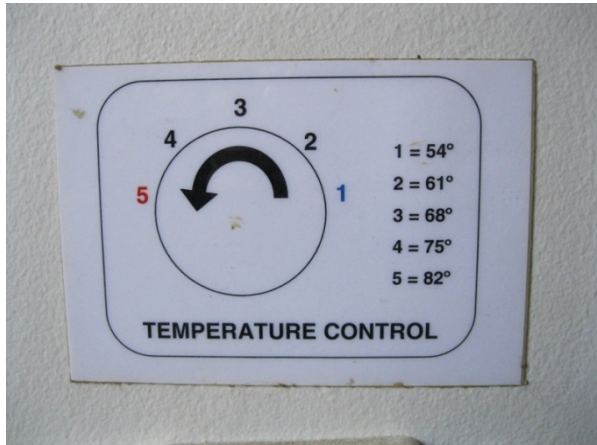

(c)



(d)

Figure 2. Pre-existing boiler controllers (a, b) and local radiator controller (c, d)

Figure 3 shows the approximate boiler reset schedules previously used in two of the buildings. Building 4, which had a more modern Tekmar controller, was set more aggressively to reduce the hot water supply temperature. The 1990s vintage Weil McLain controller was set on a less aggressive slope. As a result, on April 7, 2011 when outdoor temperatures were 45°–50°F, the supply temperature was about 30°F higher in Building 3. This is consistent with the finding (based on utility bill analysis) that Building 3 consumed 17% more space heating fuel per square foot than Building 4. The large data points in Figure 3 represent the settings on that day. The other points define the schedules for the respective controllers.

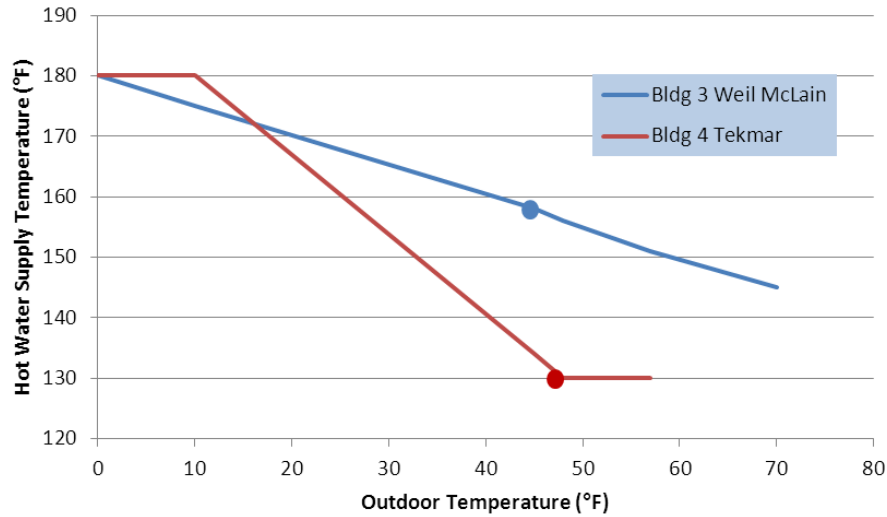

Figure 3. Approximate previously existing boiler reset schedules

An aerial view of the property indicating divisions between buildings is shown in Figure 4. Each building comprises three attached sections, each with its own address number. Each section contains one or two apartments on each of three floors. Heating system risers are located under each line of radiators in the front and back sides of the buildings with one riser serving each radiator in the first-floor apartment and a second riser serving radiators on both the second and third floors.

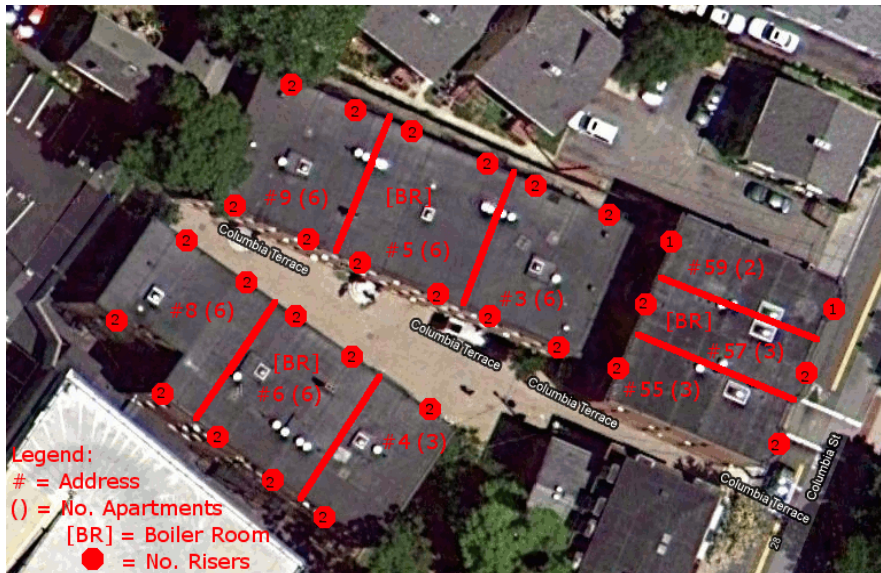

Figure 4. Aerial photo showing divisions of buildings and number of units²

² Note that each building is composed of three attached sections, each with its own address; the buildings are referred to in this report using one of these addresses (3, 4, or 55).

Each building has a boiler room in the central portion of the basement. Buildings 3 and 4 (each row of building sections is referred to by its lowest address number) both have three 87% annual fuel utilization efficiency 175,000 Btu/h input boilers supplying space heating. Building 55 has two 87% annual fuel utilization efficiency space heating boilers. Each building also has an additional boiler dedicated to supplying domestic hot water (DHW). Figure 5 shows a system diagram typical of the three buildings.

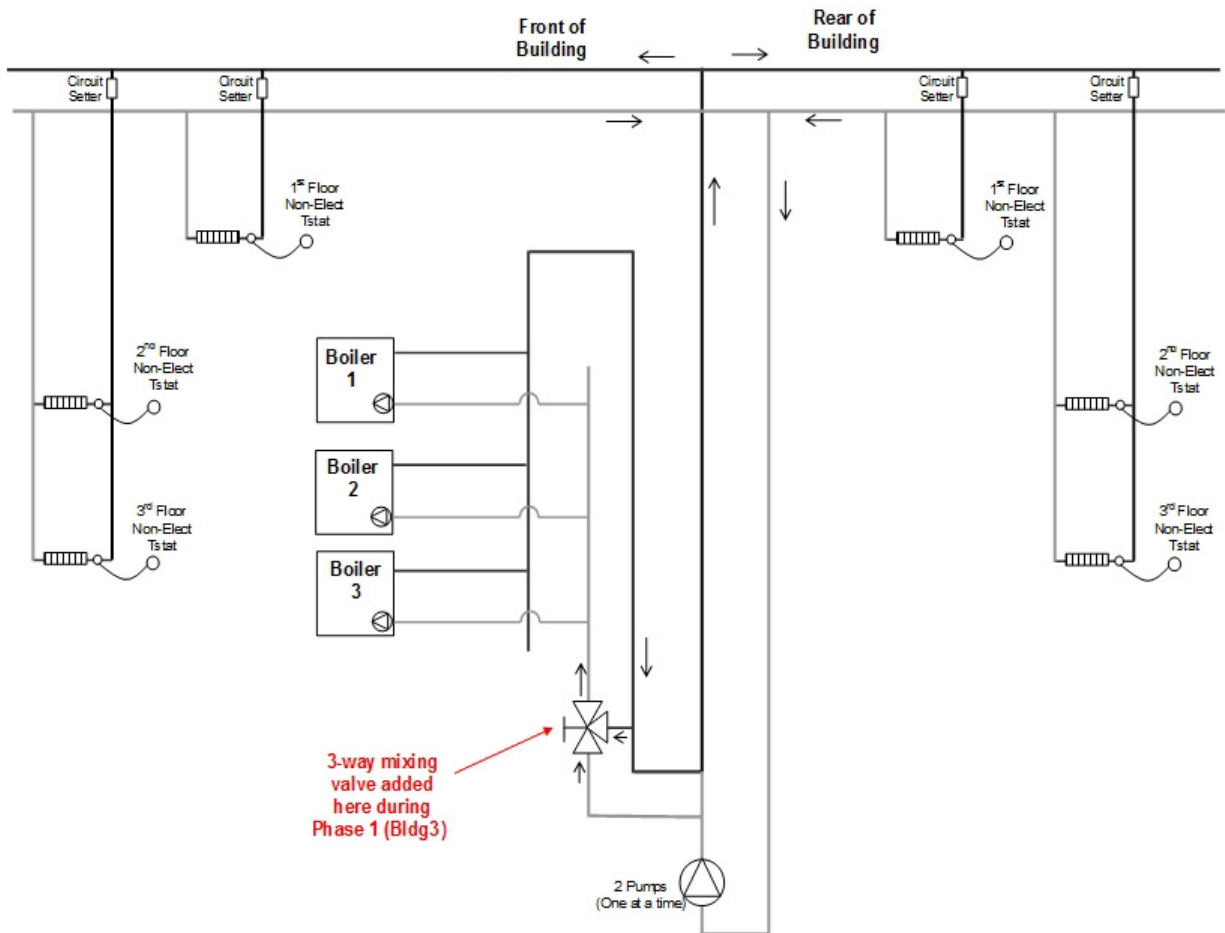

Figure 5. Typical space heating system diagram

4 Retrofit Strategies and Monitoring Plan

Boiler controls were replaced in all three Columbia CAST buildings as part of the retrofit. Table 1 describes the pre-existing control systems and retrofit measures. Table 2 describes the pre- and post-retrofit boiler controller settings.

Table 1. Existing and Planned Retrofit Controllers

Buildings by Addresses			
	Building 3 (18 apartments)	Building 4 (15 apartments)	Building 55 (9 apartments)
Boiler Quantity and Age	(3) 8 years	(3) 3 years	(2) 1.5 years
Original Boiler Controller	Weil-McLain System 1	Tekmar 264	Weil-McLain System 1
Boiler Return Water Temperature	Boilers designed to operate at a return water temperature $\geq 140^{\circ}\text{F}$. This limits the potential efficiency of the controller's outdoor temperature reset function.	Boilers designed to operate with a return water temperature $\geq 140^{\circ}\text{F}$. This limits the potential efficiency of the controller's outdoor temperature reset function.	Boilers have a built-in bypass to allow building return water temperature as low as 60°F .
Retrofit Controls	Added new boiler controller (Intech 21) and indoor temperature sensors in every apartment to limit heating when average indoor temperatures reach a set point.	Replaced controller with new boiler controller (Tekmar 274) capable of night setbacks. No indoor temperature sensors.	Replaced controller with new outdoor reset controller (Tekmar 274) capable of night setbacks. No indoor temperature sensors.
Retrofit Mixing Valve	Added new 3-way mixing valve and controller (Intech 21)	Added new 3-way mixing valve and controller (Tekmar 362—eventually abandoned)	No mixing valve added

Note that this report summarizes the status of the project at the conclusion of the 2011–2012 heating season. As can be seen in Table 2, during this first season various control settings and system configurations were altered as the systems were adjusted to maximize comfort and energy savings. The performance of the systems will be monitored during the 2012–2013 season and an updated final report will be prepared.

Table 2. Pre- and Post-Retrofit Boiler Controller Settings

Parameter (°F)	Building 3		Building 4		Building 55	
	2010–2011	2011–2012	2010–2012	2011–2012	2010–2011	2011–2012
Night Setback	0	0	0	0 3/23/12: 5	0	0 2/2/12: 10 2/7/12: 5
Reset Curve Boiler Maximum	180	170	180	180	180	170-180
Reset Curve OAT Minimum	0	10	10	10-15	0	10-15
Reset Curve Boiler Minimum	145	130	70	70	145	70
Reset Curve OAT Maximum	70	50	70	70-82	70	70
Minimum Boiler Temperature	Unknown	110-140	130	110 3/7/12: 120	Unknown	110 3/7.12: 120
Indoor Cutoff Day	n/a	73	n/a	n/a	n/a	n/a
Indoor Cutoff Night	n/a	68	n/a	n/a	n/a	n/a
Warm Weather Shutdown (WWSD) Day	65	55	65	65	65	65
WWSD Night	65	45	65	65	65	65

4.1 Building 3

In Building 3, the new boiler control system allows for remote tracking and control of all parameters, as well as setbacks.³ It also incorporates wireless temperature sensors in all apartments that provide input into the control algorithm. When the average of the indoor sensor readings exceeds the indoor set point by the dead band (set to 2.5°F), the controller reduces heat delivered to the building by up to 100%. The system utilizes available hardware from Intech 21,

³ Setbacks are implemented by setting back the building supply water temperature.

a company that specializes in self-healing wireless networks and heating system controls. The central controller communicates with an offsite server that stores logged temperature and boiler operation data and makes these historical data available on a website. The Web-based system allows remote operation and modification of the control parameters and provides real-time access to apartment temperature data so that building operators can ensure the legally required minimum heating temperature is provided to each apartment, without requiring an excessively large safety factor. One risk of this system is that tenants using supplemental heating (or cooling) could affect temperature sensor readings inadvertently or intentionally in an effort to obtain more (or less) heat. None of this behavior was observed, and the averaging of all apartment temperatures minimizes the impact any one apartment can have on the system.

Access to these data also assists in diagnosing heating system problems and addressing tenant complaints. Figure 6 shows the controller Web interface; Figure 7 shows the boiler and mixing valve control modes, set points, and temperatures; and Figure 8 shows sample apartment temperature data. Building management and the HVAC contractor were made aware of these functions but worked through ARIES researchers to obtain system data in order to prevent changes that could have affected the research. A three-way mixing valve was added to the heating system piping (Figure 9). This successfully maintained return water temperatures above the levels that could damage the existing noncondensing boilers (140°F).

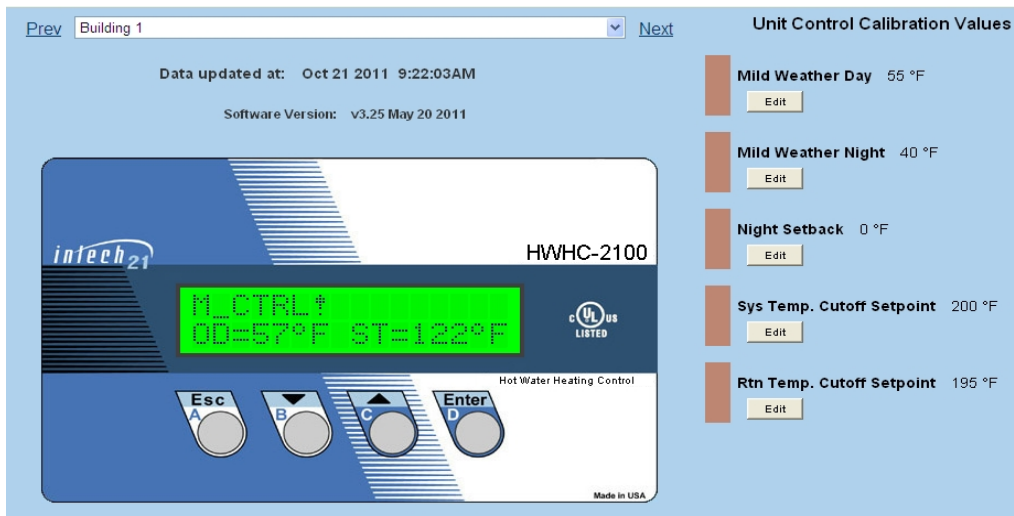

Figure 6. Controller Web interface

Heating Control													
Street	HWHC2100	Cmd Log	Control Mode	Operational State	AUTO: Target Temp, °F	SET: Target Temp, °F	System Temp, °F	Outdoor Temp, °F	Pump State	Valve Position, %	Return Water Temp, °F	Link	
3/5/7 Columbia Terrace	Building 1	Log	SET		140.0	135.0	113.7	56.7	ON	100.0	110.6	9:00 AM	
Street	HWHC2100BPT	Cmd Log	Control Mode	Operational State	AUTO: Target Temp, °F	SET: Target Temp, °F	System Temp, °F	Outdoor Temp, °F	Pump 1	Pump 2	Return Water Temp, °F	Configuration	Link
3/5/7 Columbia Terrace	Building 1	Log	SET		200.0	140.0	115.9	57.2	OFF W	OFF W	112.6	HSM	9:01 AM
Boilers	A HIGH OK B LOW OK LEAD C OFF OK												

Figure 7. Mixing valve controller (top) and boiler controller (bottom) set points and system temperatures

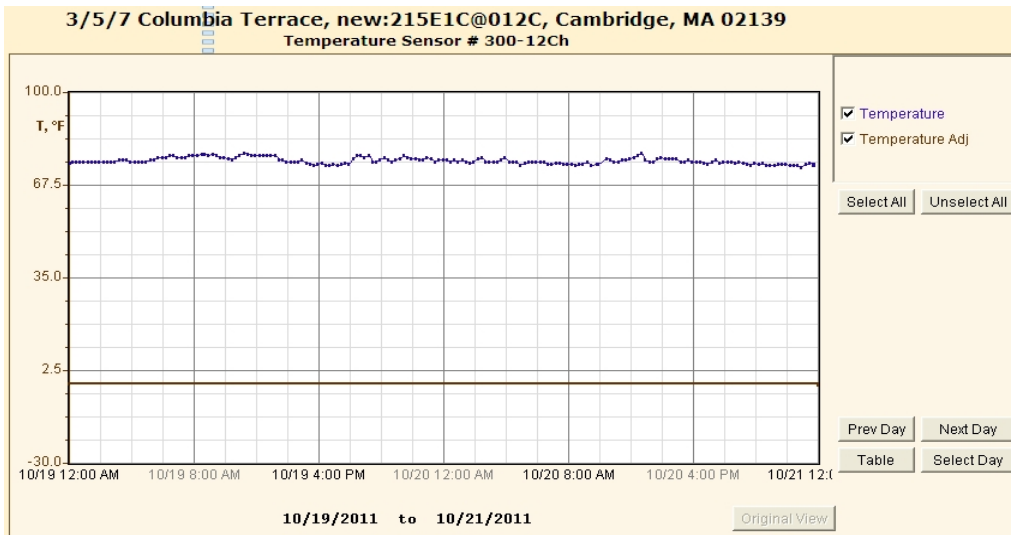

Figure 8. Sample apartment temperature sensor data

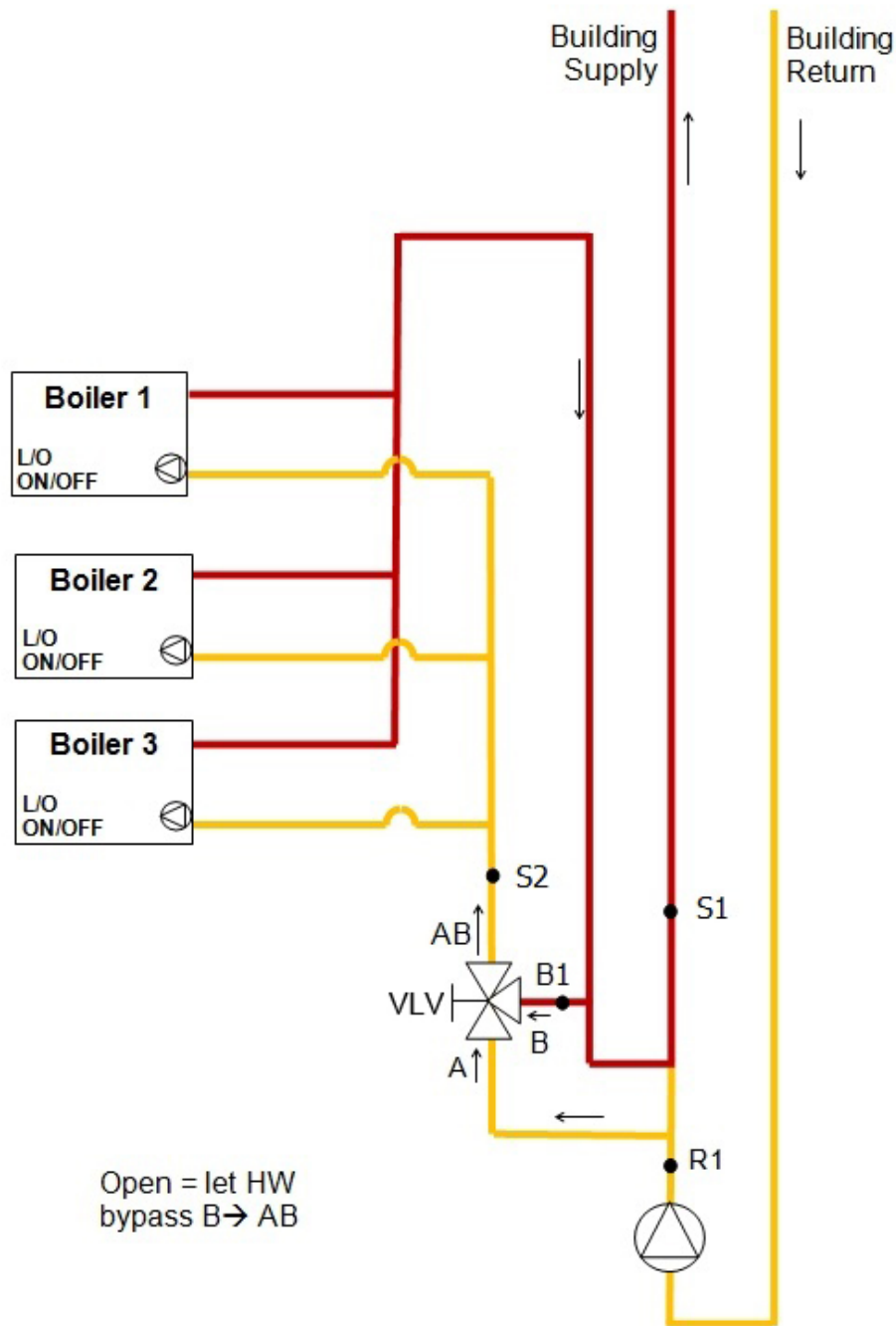

Figure 9. Building 3 system configuration

4.2 Building 4

In Building 4, new boiler controls allow for remote monitoring of all parameters. The controls permit setbacks and outdoor reset. A three-way mixing valve was added to the heating system piping (Figure 10) to maintain return water temperatures above the levels that could damage the

existing noncondensing boilers (140°F); however, as discussed below this did not function as intended and was abandoned.

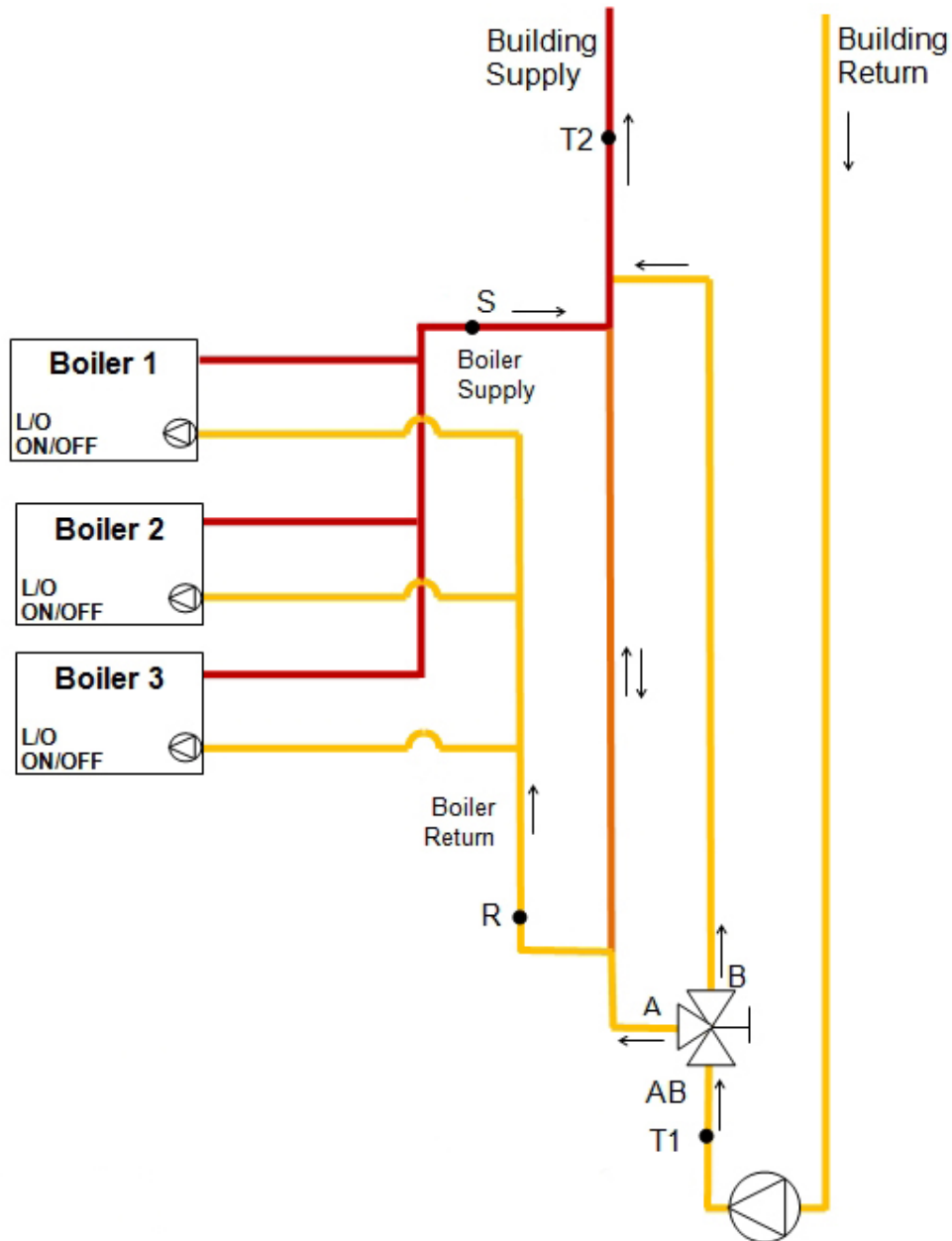

Figure 10. Building 4 system configuration

4.3 Building 55

The new controller in Building 55 is capable of setbacks. The boilers in Building 55 have a built-in bypass to mix hot water from the boiler outlet with colder return water (as low as 60°F) from the building prior to entry to the boiler sections when needed to prevent thermal shock and

condensation of flue gases in the boiler. Therefore the addition of a new three-way mixing valve was unnecessary (Figure 11).

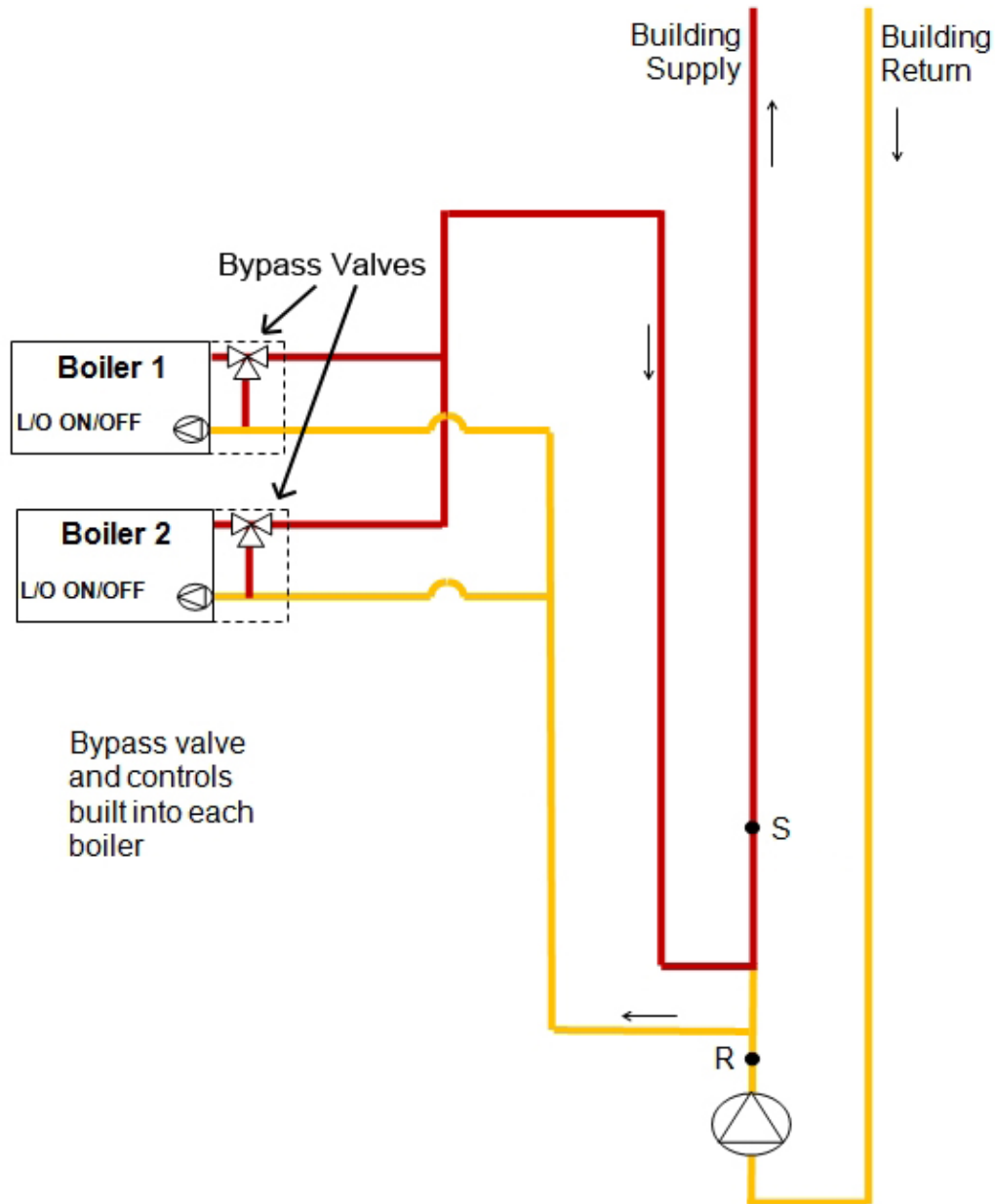

Figure 11. Building 55 system configuration

4.4 Data Collection

Data to evaluate energy savings and comfort impacts were collected under a number of control scenarios for each building. Table 3 summarizes the data collection in Building 3. The data were logged approximately every 15 minutes. Location codes in the table refer to Figure 9.

Table 3. Summary of Monitoring Data Points in Building 3

Data Point Name	Description	Location	Engineering Units
TZi	Temperature in Apartment Using Networked Sensors	All 18 apartments	°F
TBP	Temperature of Bypass Water	B1	°F
TAO	Temperature Outdoor Air (used by controller)	Outside	°F
TWS	Temperature of Hot Water Supplied to Building	S1	°F
TWR	Temperature of Hot Water Returned From Building	R1	°F
TBR	Temperature of Hot Water Entering the Boilers	S2	°F
SB1-3	Cumulative Runtime on Boilers	Each of 3 boilers	Hours
VLV	Mixing Valve Position	VLV	% open
NG	Natural Gas Usage From Monthly Utility Billing	Wegowise	Therms

One networked temperature sensor is installed in a central location on an interior wall in each apartment in Building 3 (data point TZi). These sensors provide information on comfort levels and evenness of heat distribution throughout the building from apartment to apartment. Accuracy was checked by a handheld temperature sensor at three locations in each apartment in November 2011 and March 2012 and the system was calibrated accordingly.

Firing or runtime for each single-stage boiler is totaled for each 15-minute period (SB1-3). This is compared to monthly gas use to corroborate the boiler input rates. This information is used to predict gas use for more finely resolved time intervals (daily, hourly, 15-minute) than are available from the utility bills.

The Columbia CAST buildings are enrolled in Wegowise.com, a system that automatically tracks monthly utility use and costs and uploads the data to a website that permits analysis and comparison with other buildings. This system is used to access monthly gas consumption (NG).

The Tekmar systems were configured to collect 1-minute data using a Mac Mini server. The sensors are read every few seconds and averaged into 1-minute intervals. Boiler plant operation percentage indicates the runtime of the boiler. Since the boilers are single stage, runtime is proportional to capacity.

Table 4 and Table 5 summarize the data collection in Building 4 and Building 55, respectively. Location codes in the tables refer to Figure 10 and Figure 11, respectively.

Table 4. Summary of Monitoring Data Points in Building 4

Data Point Name	Description	Location	Engineering Units
TBS4	Boiler Supply Temperature	S	°F
TBR4	Boiler Return Temperature	R	°F
TAO4	Temperature Outdoor Air (used by controller)	Outside building	°F
TWS4	Supply Temperature to Building	T2	°F
TWR4	Return Temperature From Building	T1	°F
TBT4	Target Supply Temperature for Boilers	274 Set pt	°F
SB4	Boiler Plant Operation Percentage ⁴	0, 33, 66, 100	%
NG	Natural Gas Usage From Monthly Utility Billing	Wegowise	therms

Table 5. Summary of Monitoring Data Points in Building 55

Data Point Name	Description	Location	Engineering Units
TBS55	Boiler/System Supply Temperature	S	°F
TBR55	Boiler/System Return Temperature	R	°F
TAO55	Temperature Outdoor Air (used by controller)	Outside building	°F
TBT55	Target Supply Temperature for Boilers	Set point	°F
SB55	Boiler Plant Operation Percentage	0, 50, 100	%
NG	Natural Gas Usage From Monthly Utility Billing	Wegowise	therms

Temperature sensors log the temperature in individual boiler returns in Building 55 (TBR55), where the two boilers have built-in bypass valves to mix hot water from the boiler outlet with colder return water from the system prior to entry to the boilers when needed to prevent condensation of flue gases in the boiler. When this return temperature is higher than the main building return temperature, it indicates that the valve is open.

4.5 Equipment

Table 6 describes the materials and equipment being used to collect the data described above.

⁴ The % indicates the runtime of the boiler. Because the boilers are single stage, runtime is proportional to capacity.

Table 6. Materials and Equipment

Measurement	Equipment
Space Temperatures, 15-Minute Intervals	Temperature sensors in each apartment (Building 3) connected to wireless communications network
Outdoor Temperature Boiler Runtimes Mixing Valve Position, 15-Minute Intervals Boiler Firing Times Supply, Return, and Boiler Water Temperatures	Data logged via Internet-enabled controller (Building 3) or via standalone data logger (Buildings 4 and 55)
Return Boiler Water Temperatures, Building 55	Data collected via standalone data logger
Natural Gas Usage	Utility bills via Wegowise.com

5 Methodology

In order to estimate the reduction in heating energy consumption due to the newly installed control systems, a regression technique was used. Regression is a statistical technique that estimates the dependence of a variable of interest (such as energy consumption) on one or more independent variables, such as ambient temperature, and can be used to estimate the effects on the dependent variable of a given independent variable while simultaneously controlling for the influence of other variables. This procedure can also be used to provide a deeper understanding of how and when energy is used. In addition to estimating energy savings, the uncertainty in energy savings calculations can also be calculated.

In order to obtain accurate predictions, the sample of energy data used for a regression model should be representative of the overall heating season. For energy consumption, the baseline modeling period should cover most of the full range of operating conditions. For this project, we obtained monthly energy consumption data from energy bills that differ month-to-month, not only because of the weather, but also because the number of days in the months may differ. To cope with this situation, we divided total energy use (dependent variable) in each month by the number of days in each month to obtain the average therms per day. Note that linear regression assumes that the x-values (outdoor temperatures) are known exactly, with no measurement errors. There are various types of linear regression models used for estimating energy consumption or savings. In this work, a three-parameter heating change point model was used as described below (Regression for M&V: Reference Guide, 2011).

Typically multifamily buildings provide space heating only if the outdoor air temperature (OAT) falls below a certain threshold known as the WWSD. Therefore, heating energy use may be proportional to ambient temperature, yet only below the WWSD temperature; if the OAT goes above the WWSD, the heating energy use does not continue to decrease. Energy associated with DHW use is similar across all seasons. Under these circumstances, a three-parameter *change-point* linear regression has a better fit than a simple regression model. Because of the physical characteristics of buildings, the data points have a natural two-line angled pattern to them.

The following equation was used to calculate energy consumption using a three-point model:

$$Y = Y_c + m \times (T - T_c)^-$$

Y	= The value of the dependent variable (Energy use)
Y_c	= Temperature-independent energy use
m	= The linear dependence on the independent variable (slope)
T	= The value of the independent variable (ambient temperature)
T_c	= Change-point temperature
$(T - T_c)^-$	= Indicates that the values of the parenthetic term are set to 0 when they are positive

Pre-and post-boiler controller specifications are provided in Table 2. The change point temperature (T_c) was taken as 65°F for all buildings pre-retrofit (the WWSD) and for buildings 4 and 55 post-retrofit. T_c was taken as 55°F for Building 3 post-retrofit (the post-retrofit WWSD for Building 3). Ambient hourly temperature data are used from the Logan Airport weather station in Boston, Massachusetts.

6 Results and Analysis

Each of the three buildings was operated in a variety of control states over the course of the heating season (see Table 7). This section describes the control strategies employed and the results in terms of boiler run time, system temperatures and other factors for each building.

6.1 Building 3

The new control strategy for Building 3 incorporated two major changes from the previously existing controller.

1. Reset schedule. The original Weil McLain controller had the following settings: Supply temperature of 180°F at 0°F outdoor temperature, decreasing to 145°F at 70°F outdoor temperature with a WWSO of 65°F for both day and nighttime. The new controller was set to a return temperature of 170°F at 10°F outdoors, and 130°F at 50°F outdoors with a WWSO of 55°F daytime and 45°F nighttime. Controlling to return instead of supply water temperature is thought to result in a more stable system.
2. Indoor cutoff. The new controller cut off the boilers when the average indoor temperature (from apartment temperature sensors) was above 73°F daytime and 68°F nighttime. This function was enabled on April 5, 2012.

Table 7. Data Collection Periods for Each Building

Time Period	Building 3	Building 4	Building 55
September 27, 2011	Constant return water temperature	Constant high temperature	Outdoor reset
February 2, 2012		Outdoor reset	Added nighttime setback
February 17, 2012	Added outdoor reset		
March 23, 2012		Added nighttime setback	
April 5, 2012	Added indoor cutoff		
May 25, 2012	End of heating season		

Figure 12 shows the system temperature for the three different periods with Intech control:

- January 1 to February 16 (black crosses): During this period, outdoor reset was not enabled. The system was operated with a fixed return water temperature that differed only during daytime (180°F) and nighttime (170°F) due to a nighttime setback. The two black horizontal groups of data points reflect these two system set points.
- February 17 to April 4 (red stars): Outdoor reset was enabled on February 17. The system temperatures are significantly lower during this period. However, because a number of

other adjustments to controller settings were made during February and March, a clear trend line is not evident.

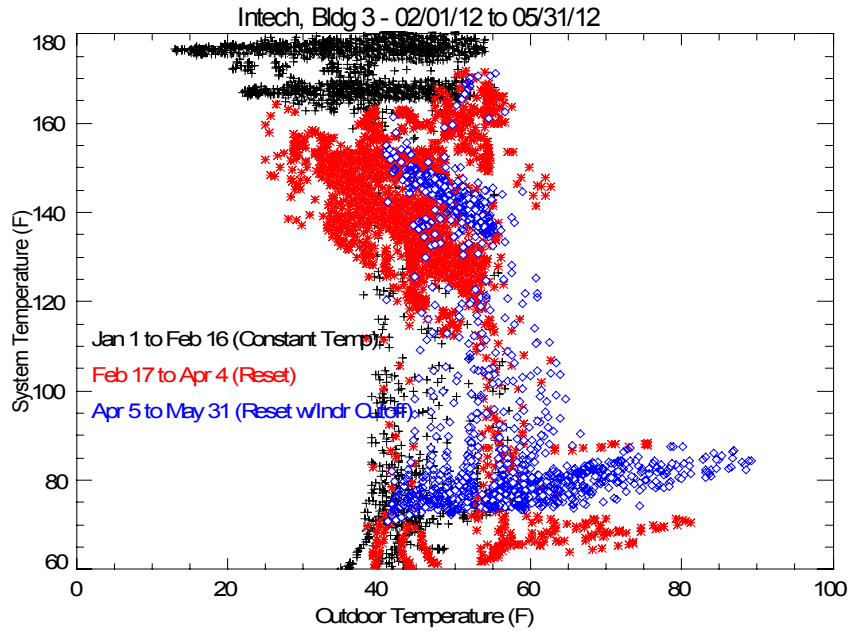

Figure 12. Building 3 system temperature versus outdoor temperature

- April 5 to May 31 (blue diamonds): During this period, control settings were fixed and indoor cutoff was added. A trendline is evident, indicating the outdoor reset. Many data points are at the bottom of the plot during this period because of the greater incidence of WWSD during this time of year.

Figure 13 shows the system temperature compared to the average indoor temperature from the apartment temperature sensors. The red data points (stars) are from the period prior to indoor cutoff; the blue data points (diamonds) are during indoor cutoff. The lack of blue data points to the right of approximately 74°F indoor temperature confirms that this function was operating: there is no boiler operation above 74°F average indoor temperature. Indoor temperature cutoff was set at 73°F during the day and 68°F at night, with a 2.5°F dead band.

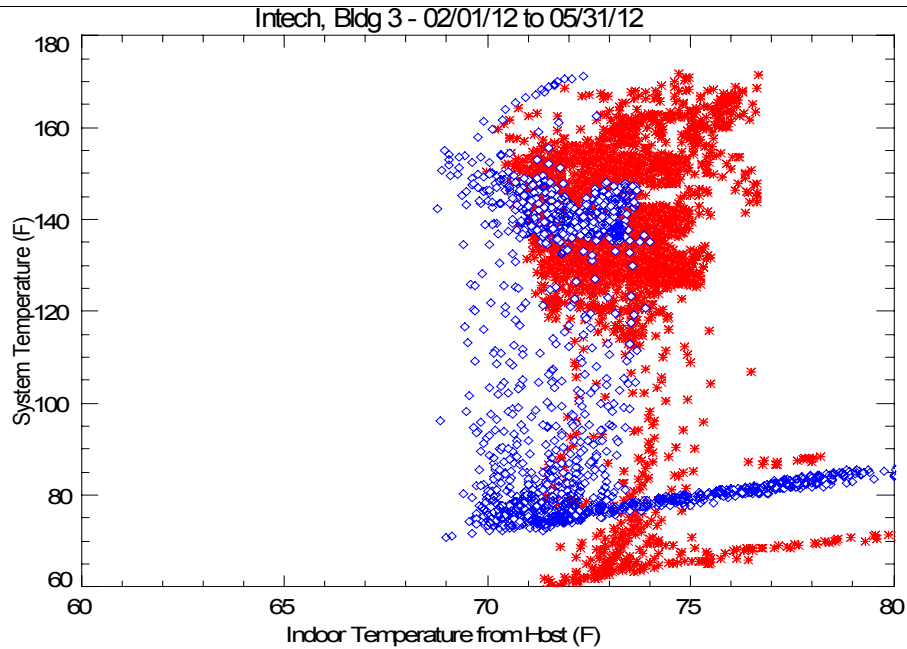

Figure 13. Building 3 system temperature versus average indoor temperature

6.2 Building 4

The new control strategy for Building 4 incorporated two major changes from the previously existing controller.

1. Reset schedule. The original Tekmar controller had the following settings: Supply temperature of 180°F at 10°F outdoor temperature, decreasing to the 130°F minimum boiler supply temperature at about the 48°F outdoor temperature observed on April 7, 2011. The new controller was set to 180°F at 10°F outdoors (increased to 15°F partway through the winter), with the same curve characteristics as the previous controller, however with a 2°F lower indoor target temperature (70°F instead of 72°F). The minimum boiler supply temperature was set at 140°F and reduced to 110°F over the course of the season.
2. Nighttime setback. The new controller incorporated nighttime setback, implemented on March 23, 2012 with a 5°F setback.

The Building 4 data (Figure 14) show the boiler supply and return temperatures, which are set to a higher temperature because the mixing valve controlled the system temperature. Note that the 140°F minimum is not always achieved and the boiler firing pattern is irregular. The cause of this was a conflict between the boiler controller and the mixing valve controller. This was resolved on February 2, 2012 by fixing the valve in the open position, disabling the valve controller, and putting the boiler controller in charge of controlling supply water temperature. This was possible because it was determined that, after reviewing return water temperatures, the risk to the boilers of sub-140°F return water was low.

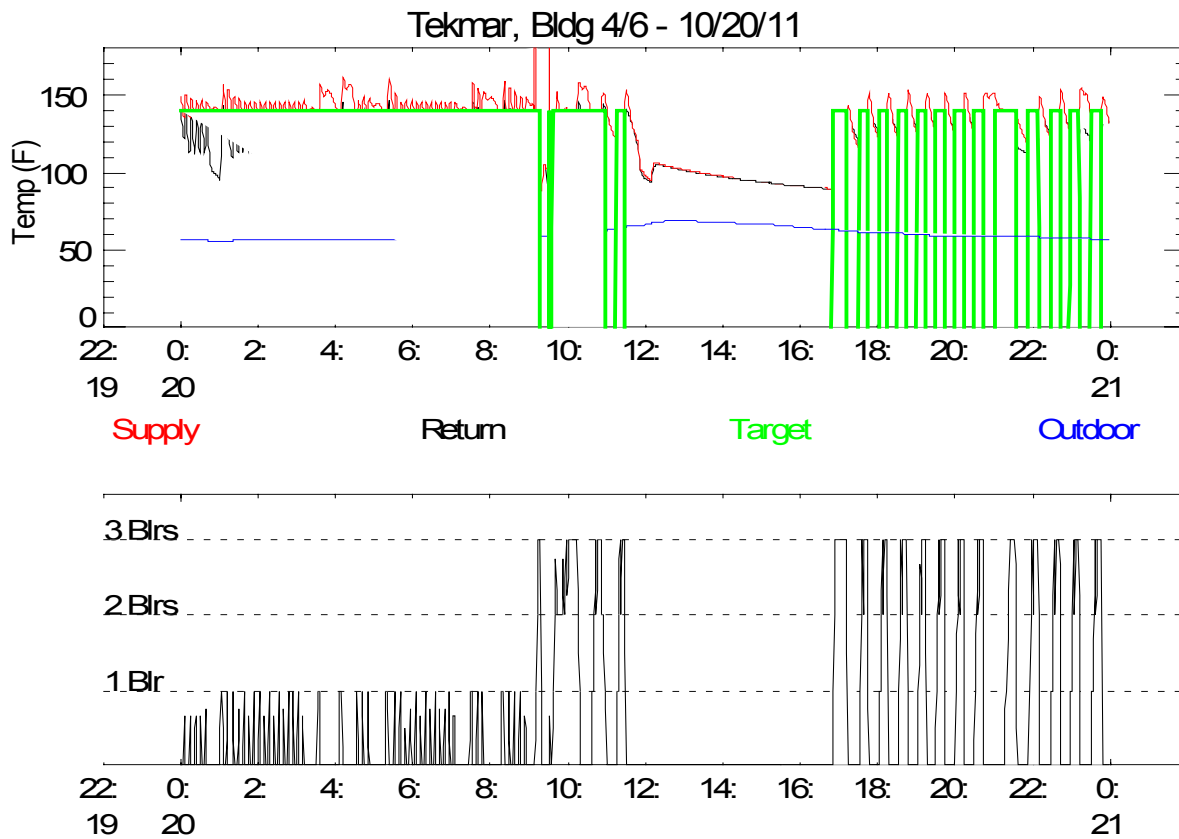

Figure 14. Building 4 boiler performance October 20, 2011

6.2.1 Outdoor Reset

Prior to February 2 the system was operating at constant high temperature control without outdoor reset. When the mixing valve controller was disabled and the outdoor reset schedule implemented on February 2, the boiler loading was reduced. The resulting data are more organized in a linear trend as compared to the scattered data before that date (Figure 15). The cause of the occasional data above the trend line is unknown.

The outdoor reset schedule (after February 2) had a noticeable impact on gas use as compared to constant high temperature. In Figure 16, the solid line is a best fit of data from August 2011 to January 2012 (before reset) and the dashed line is the best fit from February to May 2012. The stars are February and March (no night setback); the triangles are April and May (with night setback).

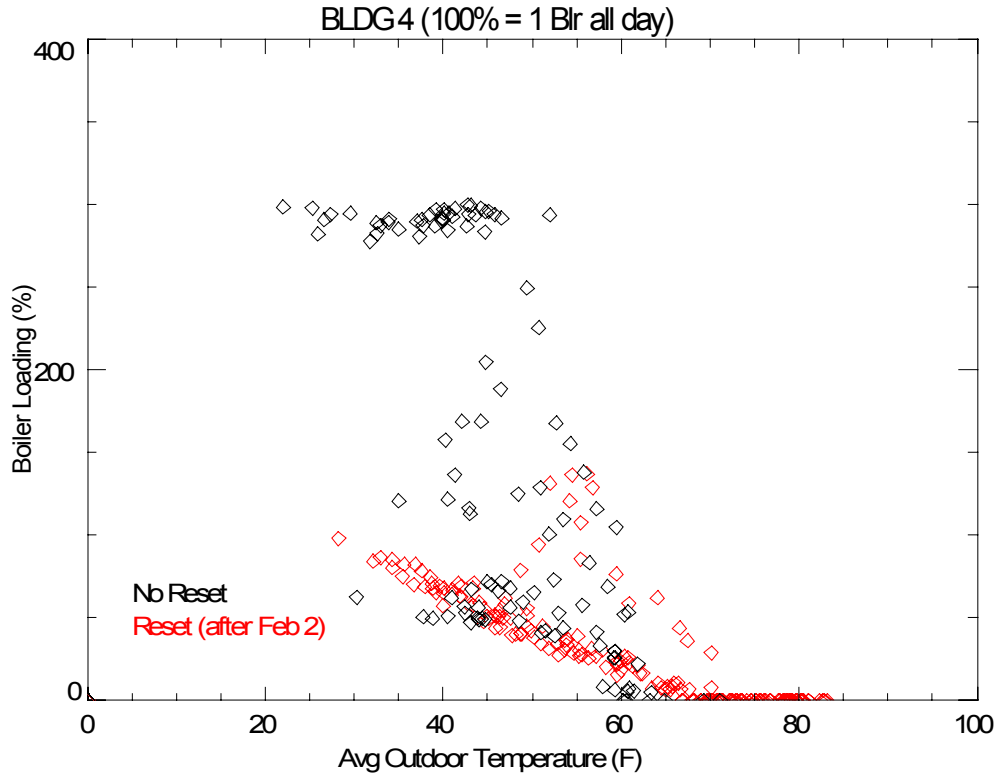

Figure 15. Boiler loading, Building 4

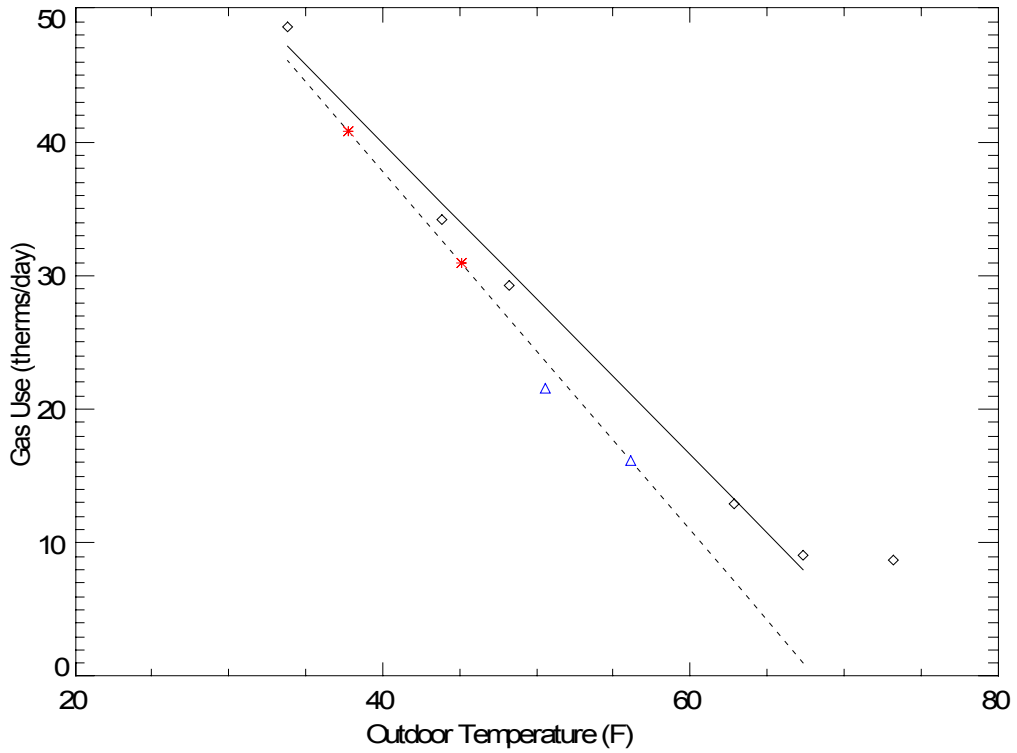

Figure 16. Gas use, Building 4

6.2.2 Nighttime Setback

Nighttime setback was implemented in March. The first evidence of noticeable setback was on March 27 at 10:00 p.m. (hour 22 in Figure 17).

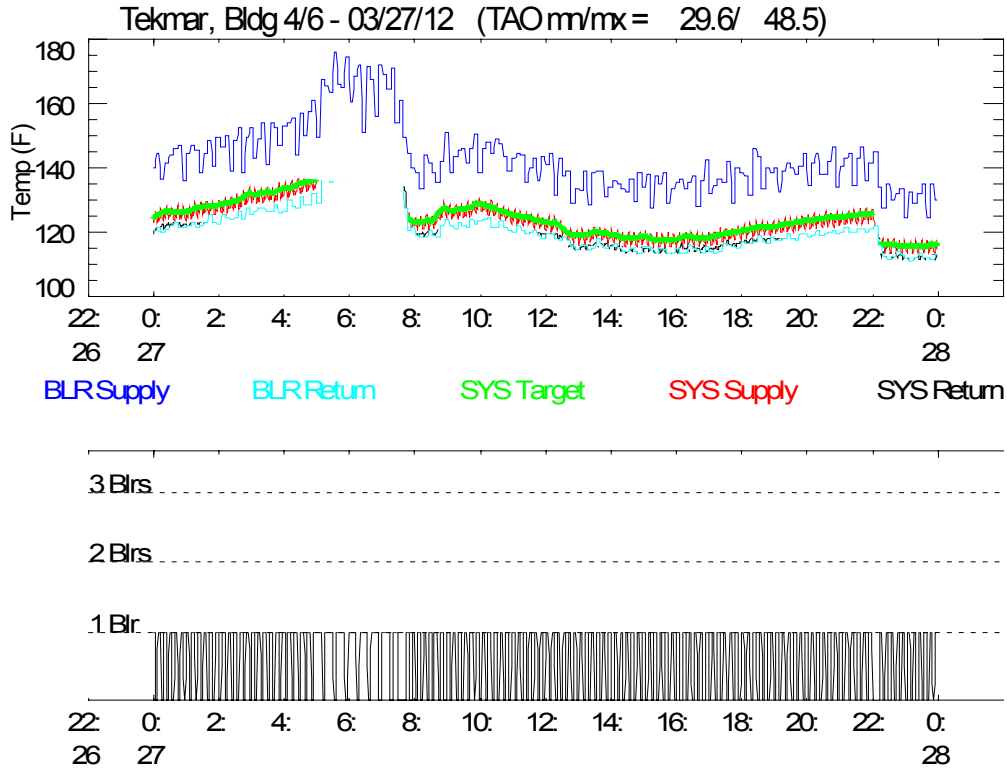

Figure 17. System temperatures and boiler loading March 27, 2012, Building 4

There was little evidence of the 5°F nighttime setback having an impact on boiler runtime. Both the days with and the days without setback fall roughly along the same boiler loading trend line (Figure 18).

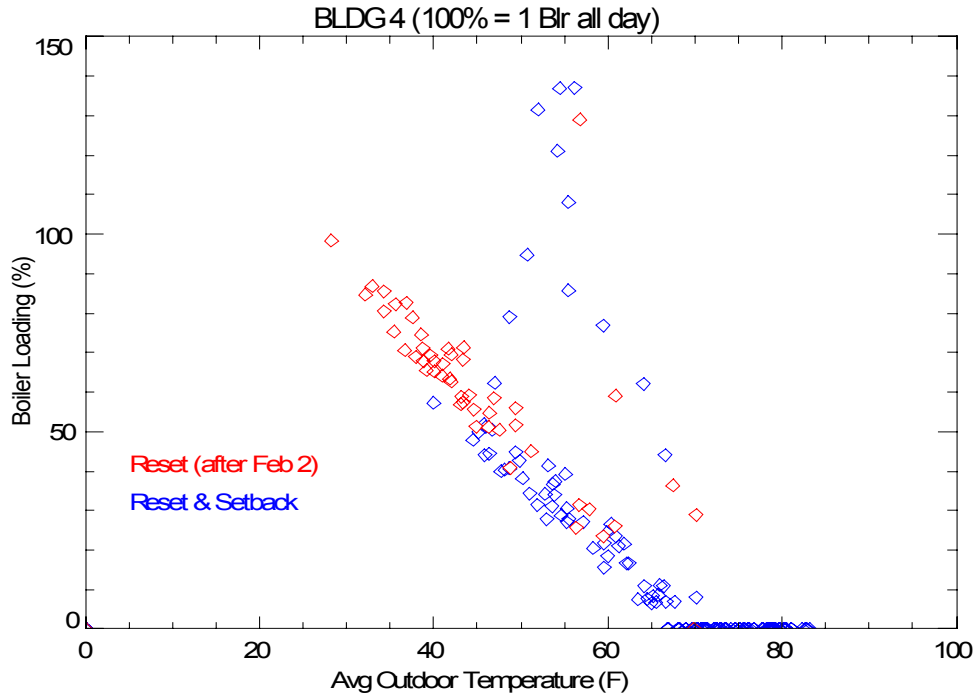

Figure 18. No impact of nighttime setback, Building 4

6.3 Building 55

The new control strategy for Building 55 incorporated two major changes from the previously existing controller.

1. Reset schedule. The original Weil McClain controller is assumed to have had the same settings found in Building 3: Supply temperature of 180°F at 0°F outdoor temperature, decreasing to 145°F at 70°F outdoor temperature. The new controller was set to be 180°F at 10°F outdoors, and 70°F at 70°F outdoors with a minimum boiler supply temperature of 110°F for most of the winter.
2. Nighttime setback. The new controller incorporated nighttime setback, implemented on February 2, 2012 with a 10°F setback and then adjusted to a 5°F setback on February 8.

The plot of the supply target temperature versus outdoor temperature (Figure 19) illustrates the reset schedule. The second shorter line below the primary line is a result of the week with 10°F night setback.

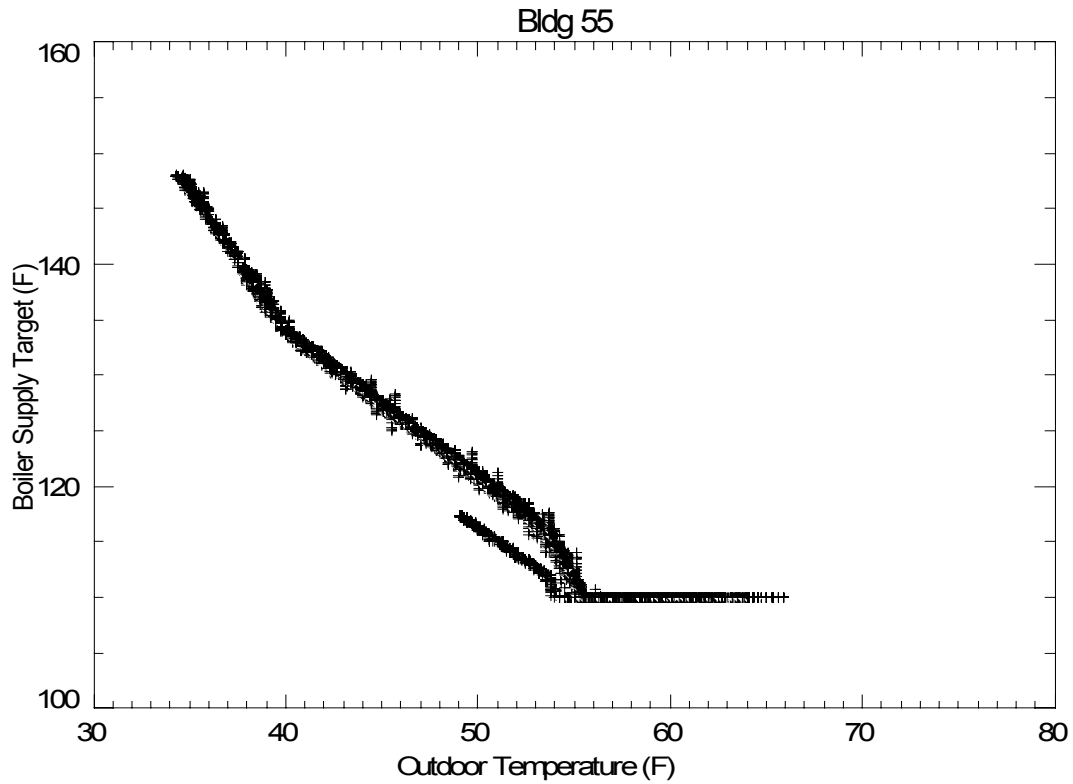

Figure 19. Boiler supply target and outdoor temperature in Building 55

6.3.1 Boiler Runtime and Gas Use Correlation

The data in Figure 20 and Table 8 show that the gas use predicted from boiler runtime is in good agreement with the actual measured gas use (from the utility bills).

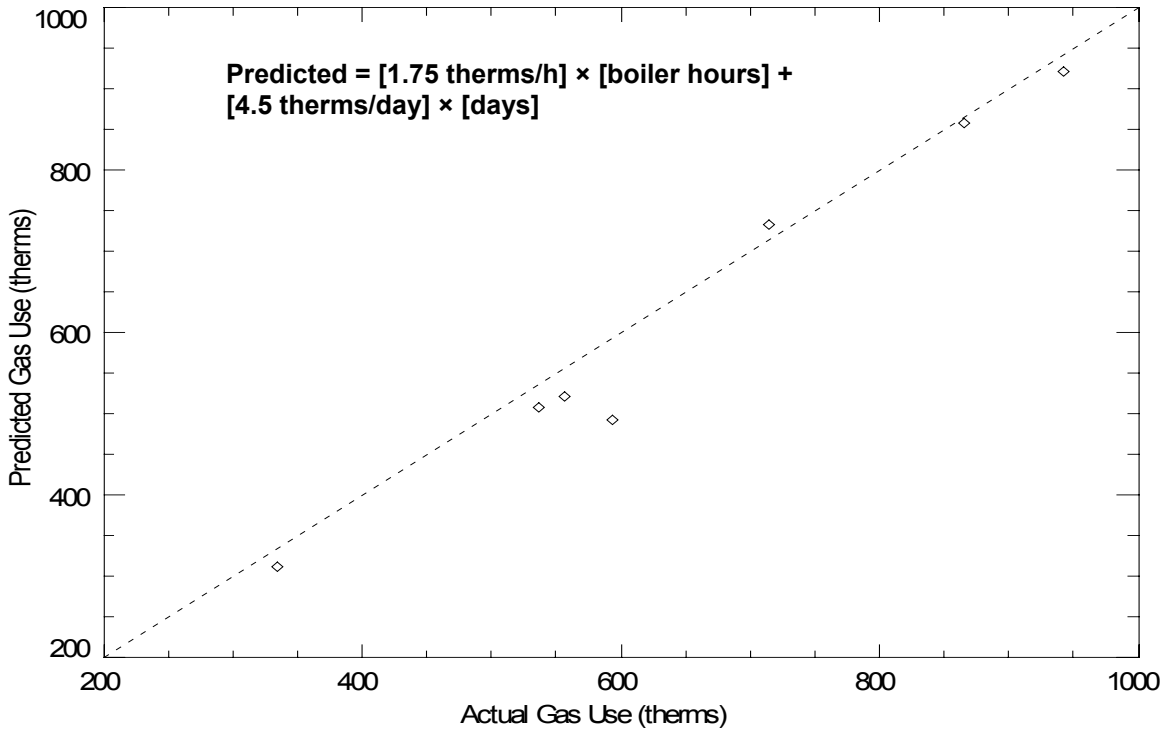

Figure 20. Plot of actual and predicted gas use

Table 8. Actual and Predicted Gas Use by Utility Billing Period

Period	Actual/Measured Gas Use (therms)	Predicted Gas Use (therms)
April 26, 2012–May 25, 2012	334	312
March 25, 2012–April 25, 2012	537	508
February 28, 2012–March 24, 2012	556	523
January 27, 2012–February 27, 2012	866	858
December 28, 2011–January 26, 2012	942	923
November 26, 2011–December 27, 2011	714	733
October 25, 2011–November 25, 2011	594	494

Note: Predicted using 1.75 MMBtu/h and assuming that DHW is 4.5 therms/day

6.3.2 Nighttime Setback

Both the gas data and the boiler runtime data show little to no impact of the nighttime setback. For comparison purposes, there are 27 days of good data with setback (from February 9 to March 6). On March 7, the minimum system temperature was changed by an HVAC technician from 110°F to 120°F. This confounded the analysis of the setback subsequent to that date.

The plot in Figure 21 shows no impact of night setback. The pre-setback periods (green diamonds) fall on the same gas use trend line as the post-setback periods (orange circles). In Figure 22, boiler loading on the pre-setback days (black diamonds) falls on the same trend line as the post-setback days (red diamonds).

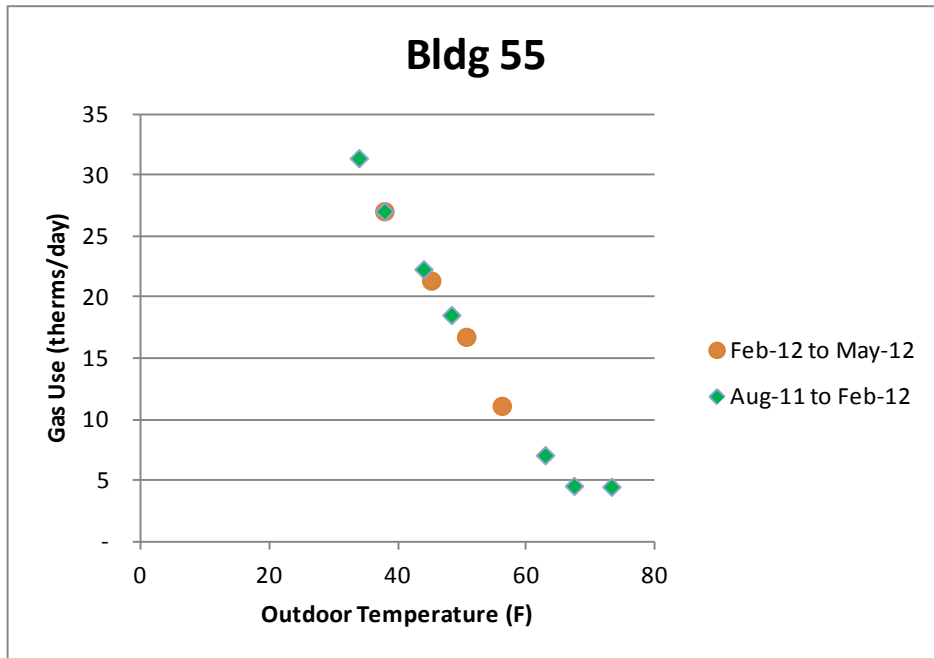

Figure 21. Plot of monthly gas use, Building 55

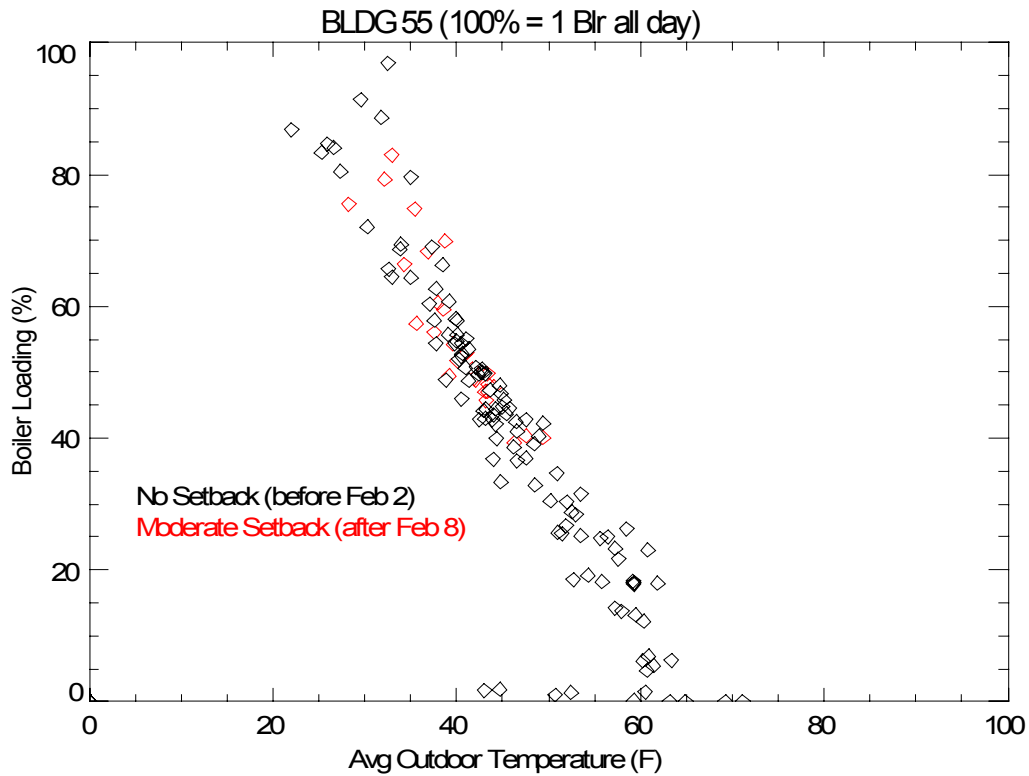

Figure 22. Plot of boiler loading—comparing days with and without setback through March 6

The plot of operating temperatures and boiler loading before and after implementation of night setback may be found in Figure 23 and Figure 24, respectively. The boiler loading plot after night setback clearly shows a small gap in boiler runtime during the setback, but an increase in runtime during the morning boost.

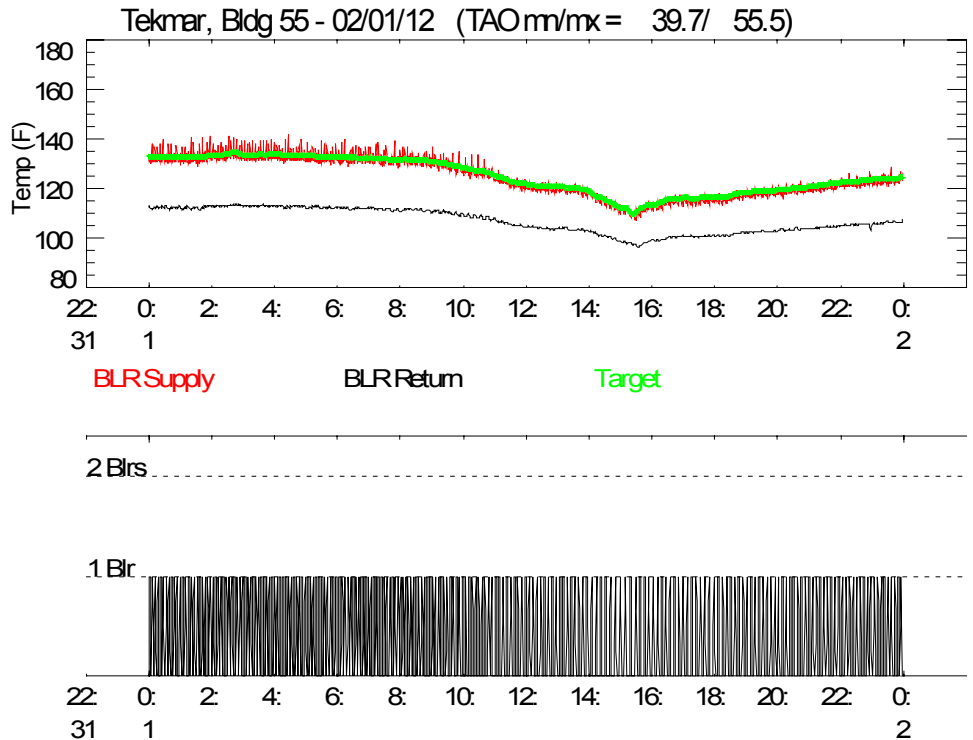

Figure 23. Operating temperatures in Building 55 before night setback

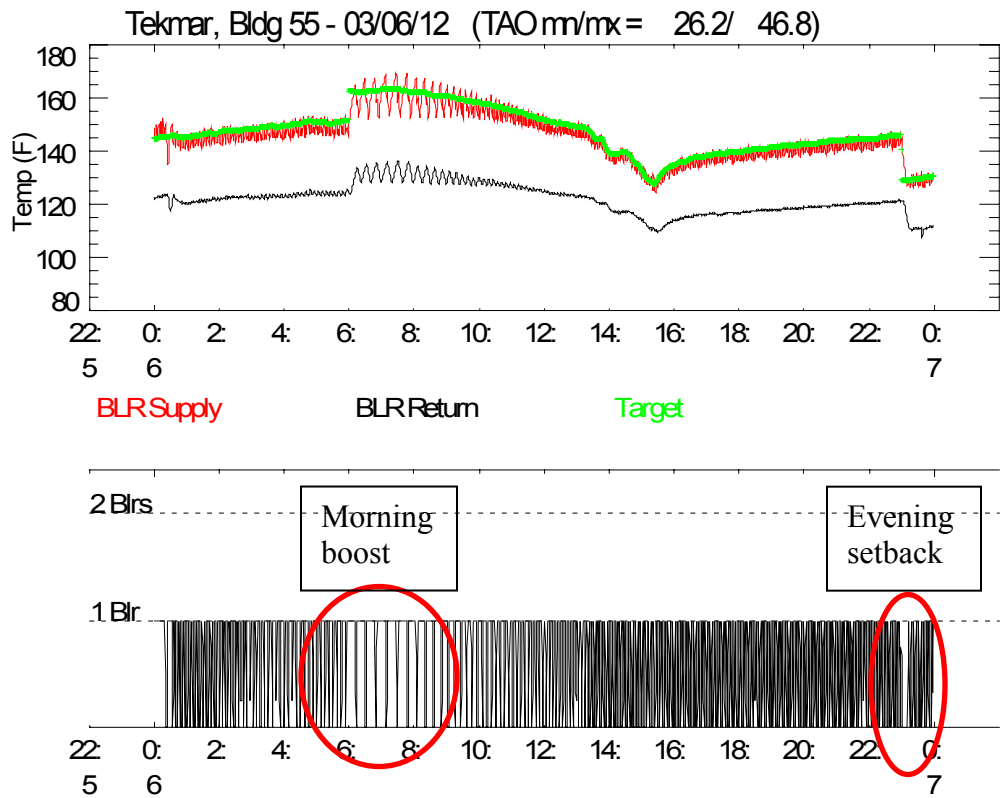

Figure 24. Operating temperatures in Building 55 with night setback

6.4 Utility Bill Analysis

ARIES obtained gas billing data for each building for each month for the pre-retrofit season (May 2010 to May 2011) and the post-retrofit season (June 2011 to May 2012). Figure 25 through Figure 27 show the dependence of space heating energy consumption in the building on outdoor air temperature for each season. Error bars show variability in the measurements. Total predicted savings from the retrofit are shown in Table 10.

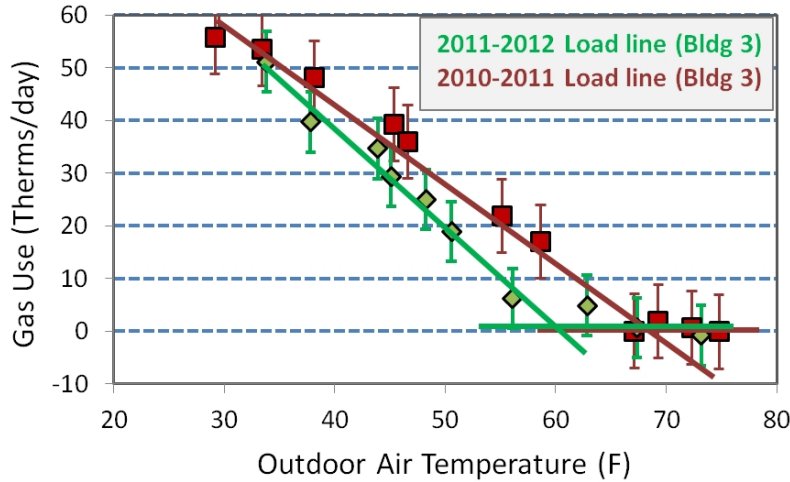

Figure 25. Building 3 dependence of energy consumption on OAT (diamonds and green line = post-retrofit; squares and brown line = pre-retrofit)

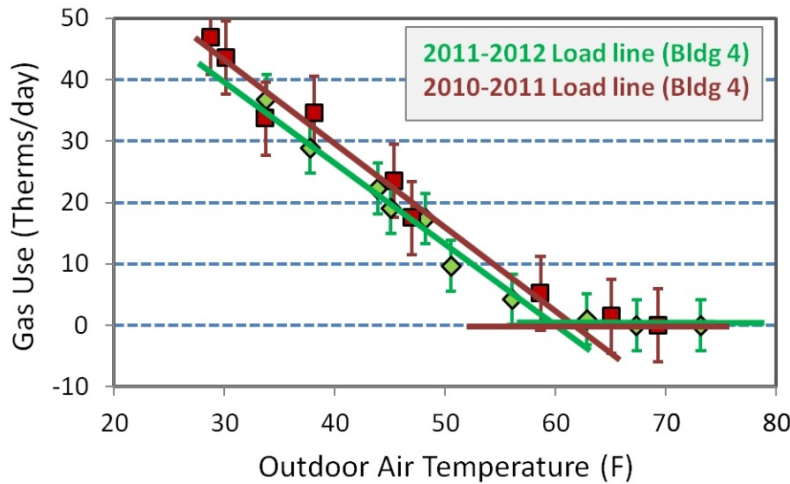

Figure 26. Building 4 dependence of energy consumption on OAT (diamonds and green line = post-retrofit; squares and brown line = pre-retrofit)

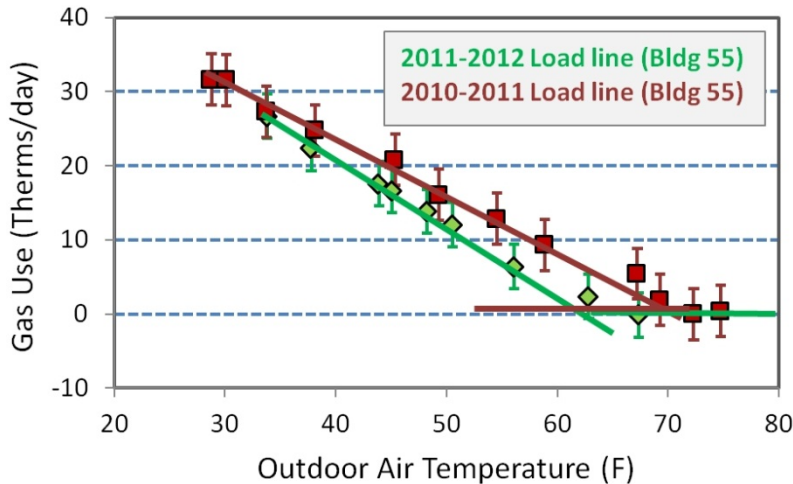

Figure 27. Building 55 dependence of energy consumption on OAT (diamonds and green line = post-retrofit; squares and brown line = pre-retrofit)

In order to estimate energy savings due to the new control system, energy consumption for the 2011–2012 heating season was weather-normalized with 2010–2011 OATs.

Based on the three parameter change point linear regression model described above, the pre- and post-retrofit slopes and intercepts for all three buildings’ energy usage were determined (Table 9). Figure 25 through Figure 27 show gas use in therms as a function of OAT for each building before and after the retrofit. Data are weather normalized. The graphs show that post-retrofit (the green load line), less fuel was required for space heating at a given OAT compared to pre-retrofit (the red load line).

Table 9. Dependence of Energy Consumption on OAT (Slope) and Coefficient of Determination (R²)

	Post-Retrofit (2011-12)		Pre-Retrofit (2010-11)	
	Equation	R ²	Equation	R ²
Building 3	$y = -1.906x + 10.365$	0.9771	$y = -1.443x + 8.662$	0.9771
Building 4	$y = -1.259x - 5.081$	0.9652	$y = -1.357x - 4.300$	0.9699
Building 55	$y = -0.883x - 1.076$	0.9973	$y = -0.699x + 6.215$	0.9924

Table 10 presents heating energy and total energy use before and after the retrofit for all three buildings. Heating energy use decreased significantly after implementing the new boiler controls.

Table 10. Pre- and Post-Retrofit Heating and Total Energy Consumption and Reduction (therms)

	Building 3		Building 4		Building 55	
	Heating	Total	Heating	Total	Heating	Total
Pre-Retrofit (2010–2011)	10,755	14,897	6,802	11,158	5,754	7,820
Post-Retrofit (2011–2012) (Normalized With 2010–2011 OAT)	8,789	12,916	6,119	10,135	4,864	6,996
Total Reduction	1,966	1,981	684	1,023	890	824
% Reduction	18.3%	13.3%	10.1%	9.1%	15.5%	10.5%

The above analysis agrees with the weather-normalized energy analyses provided by Wegowise, which all show a noticeable drop in gas use for the post-retrofit season (2011–2012) (Figure 28 through Figure 30).

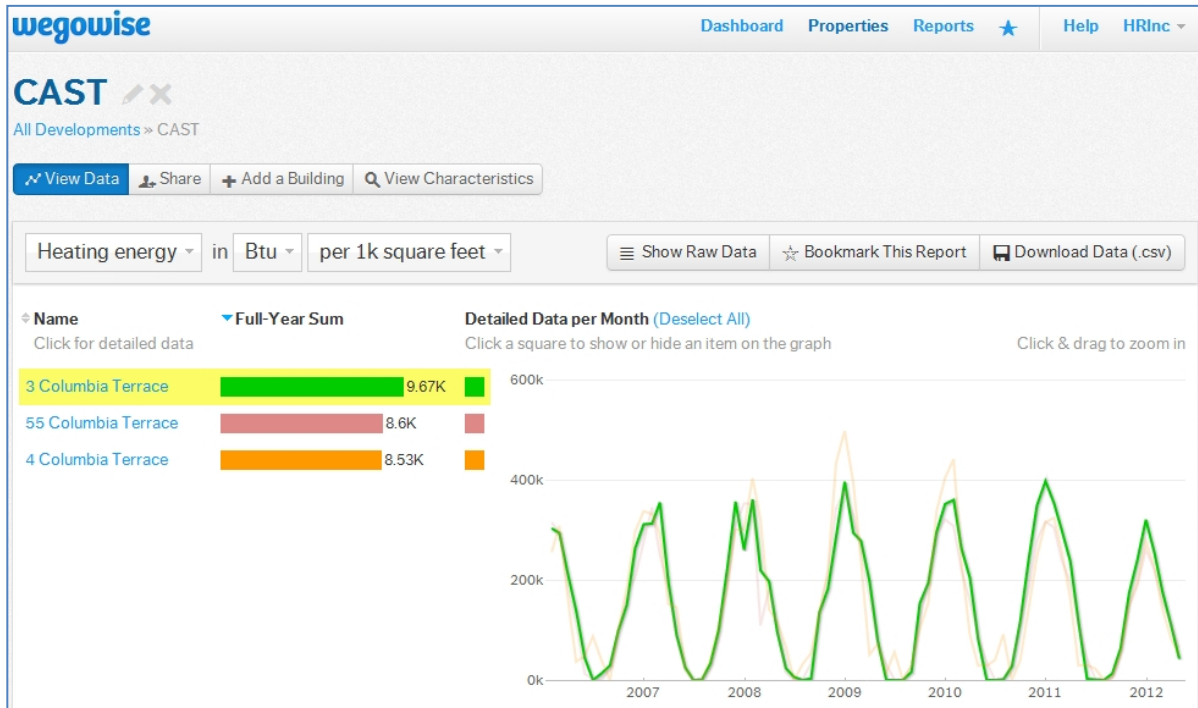

Figure 28. Wegowise gas use graph for 3 Columbia Terrace

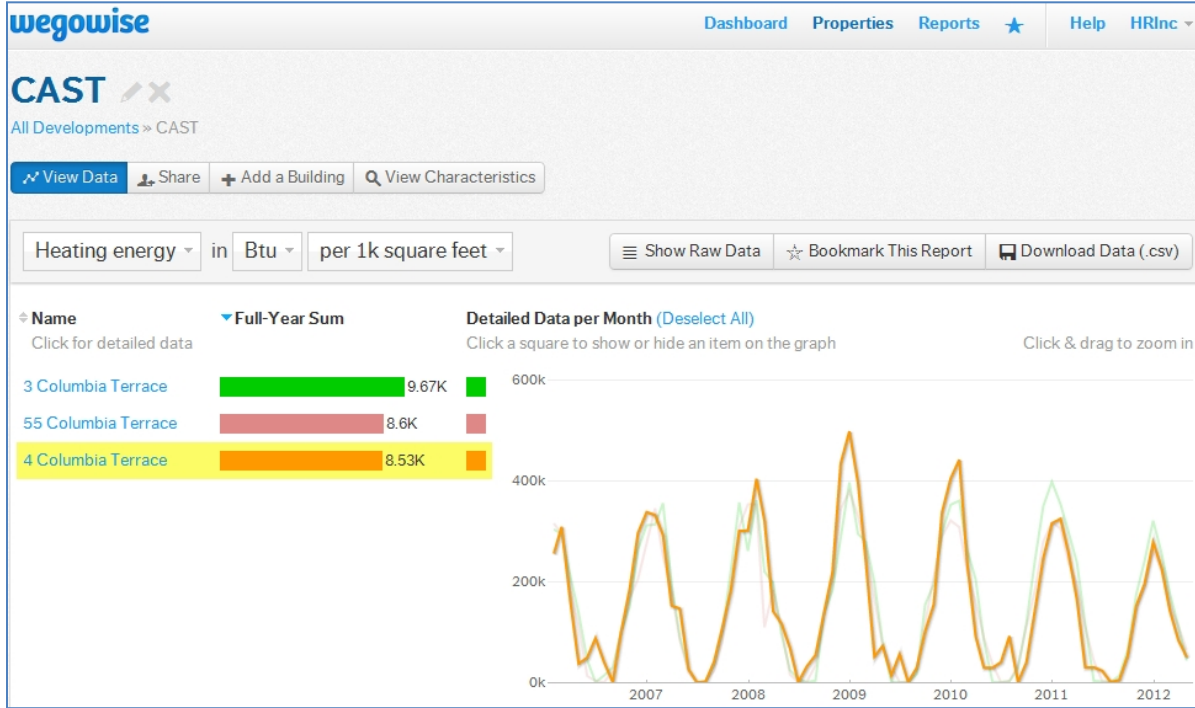

Figure 29. Wegowise gas use graph for 4 Columbia Terrace

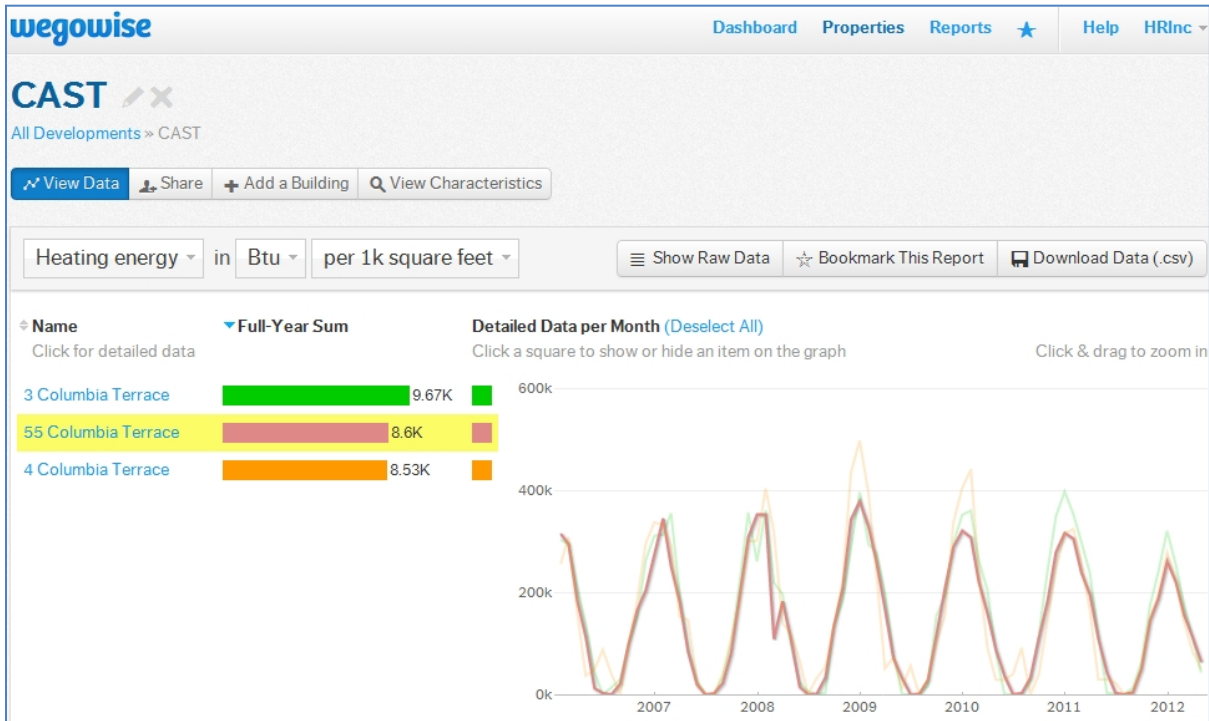

Figure 30. Wegowise gas use graph for 55 Columbia Street

6.5 Cost Effectiveness

Table 11 summarizes the major statistics for each building. The control retrofits are estimated to have saved on average about 15.2% of the space heating gas use, or 3,539 therms (or \$4,389 at \$1.24/therm) for all three buildings in 2011–2012. The cost to install the wireless sensors, boiler controls, and a Web-based system was \$21,574 for all three buildings. The simple payback is projected to be approximately 4.9 years. Note that the economics shown in Table 11 are based on 2011–2012 data and do not necessarily reflect the true savings potential when the control systems are fully operational for the complete heating season.

Table 11. Energy and Cost Savings Calculations for Heating Season 2011–2012

Building Information	3 Columbia	4 Columbia	55 Columbia	Total
Number of Apartments Served	18	15	8	41
Number of Bedrooms	45	40	28	113
Floor Area (ft²)	15,524	13,672	9,955	39,151
Gas Use for Space Heating				
Post-Retrofit 2011–1212 (therms)	8,789	6,802	4,864	19,772
Pre-Retrofit 2010–2011 (therms)	10,755	6,119	5,754	23,311
Economics				
Savings (% space heating gas)	18.3%	10.1%	15.5%	15.2%
Savings (therms)	1,966	684	890	3,539
Savings (\$)	\$2,438	\$848	\$1,103	\$4,389
Equipment Costs	\$10,610	\$1,235	\$579	\$12,424
Labor Costs	\$6,750	\$1,200	\$1,200	\$9,150
Total Costs	\$17,360	\$2,435	\$1,779	\$21,574
Cost per Apartment	\$964	\$162	\$222	\$526
Payback (years)	7.1	2.9	1.6	4.9

6.6 Other Impacts

The retrofit control systems are expected to provide other nonenergy benefits to building residents and management, including:

- **Occupant comfort:** The heating control system should improve comfort by ensuring adequate heat and reducing overheating of apartments. Achieving optimum savings may result in some apartments being cooler than occupants have become accustomed to, but still within the legal limits (Gifford 2004). A survey was conducted to gauge occupant satisfaction with the heating system. It will be repeated in 2012–2013 and the results compared in a follow-up report.
- **Occupant health and safety:** Reducing overheating reduces drying of indoor air and limits the need to open windows to allow excess heat to escape in winter, which causes cold drafts.
- **System reliability:** Potential elimination of nonelectric radiator valve controllers removes an unreliable component of the existing system (Gifford 2004).
- **Code compliance:** The system employed in Building 3 enables the property manager to more precisely and reliably comply with minimum/maximum heat laws for rental apartments through online monitoring and logging of apartment temperatures.
- **Building and equipment maintainability:** Web-enabled visibility of apartment temperatures (Building 3) and boiler/valve status permits maintenance personnel to more rapidly detect and react to maintenance issues and complaints.

7 Conclusions

This report summarizes the progress of the research. Controllers in all three buildings have been installed and the data have been collected for the 2011–2012 heating season. The following progress has been made in answering the project’s research questions:

Question 1: What are the energy savings and comfort benefits of retrofitting central boiler controllers using outdoor reset and indoor apartment temperature data into existing hydronically heated multifamily buildings?

Answer: A billing analysis based on this year’s utility bills (with new control system) and the previous years’ utility bills (with old control system) showed that the new control system saved a significant amount of space heating energy. After implementing control techniques, the overall weather-adjusted reduction in space heating gas consumption was 10.1% to–18.3% and averaged 15.2%. The simple average payback is projected to be approximately 4.9 years. It should be noted that for the 2011–2012 heating season, the new control system was implemented gradually, only becoming fully functional in all buildings in April 2012. Therefore, it is expected that weather-normalized savings will be greater in future heating seasons. Comfort effects will be more closely analyzed using indoor temperature data collected in the 2012–2013 heating season.

Question 2: How does a control system incorporating apartment temperature data compare in cost and performance with well-tuned outdoor reset strategies, including those that incorporate nighttime setback?

Answer: The data to date show significant benefits from an aggressive outdoor reset schedule, but a negligible effect of a 5°F nighttime setback of supply water temperature in the two buildings in which it was tested. An indoor temperature cutoff control feature based on average apartment temperatures appears to be having the desired effect of reducing fuel consumption in one building; however, this feature was tested for only a small portion of the season when OATs were relatively warm. Additional testing in the 2012–2013 season is needed to evaluate its effectiveness under a broader range of conditions.

8 Future Work

In 2013, the operation and performance of the three systems will be analyzed and compared for a full 2012–2013 heating season. Indoor temperature data will be collected from all three buildings and a resident survey will be conducted to evaluate comfort.

Future work may also include a study of the potential additional energy savings possible by integrating automated control of individual space heating zones into one building coupled with the new central boiler controls. In this scheme, thermostats would direct valves that control the flow of hot water to individual zones based on space temperatures in those zones. This would reduce heating energy use (i.e., overheating) by delivering heat only to where it is needed in the amounts needed.

This zone-based control research would address the question: How can local zone controls be cost-effectively integrated into a hydronic heating control system and what are the associated energy savings and comfort benefits?

Figure 31 is a diagram of this control scheme for Building 55, where the local zone control could be evaluated. New space temperature sensors would be installed in eight apartments. The temperature sensors would communicate with a controller in the basement that would control new valves installed in the basement risers in place of the current balancing valves.

Existing outdoor reset-based central boiler controls would not be altered. Based on an average of the temperature readings in each zone, the controller would vary the openings of the valves to let the optimum amount of hot water flow through the risers so that the desired space temperature in each zone would be achieved. Efficiency and comfort metrics (space dry bulb temperature, consistency of adherence to set point) will be compared for this building with and without the local controls.

Results for the local zone control research would include an estimate of the potential energy savings from adding automated local zone controls to a central outdoor reset boiler control strategy.

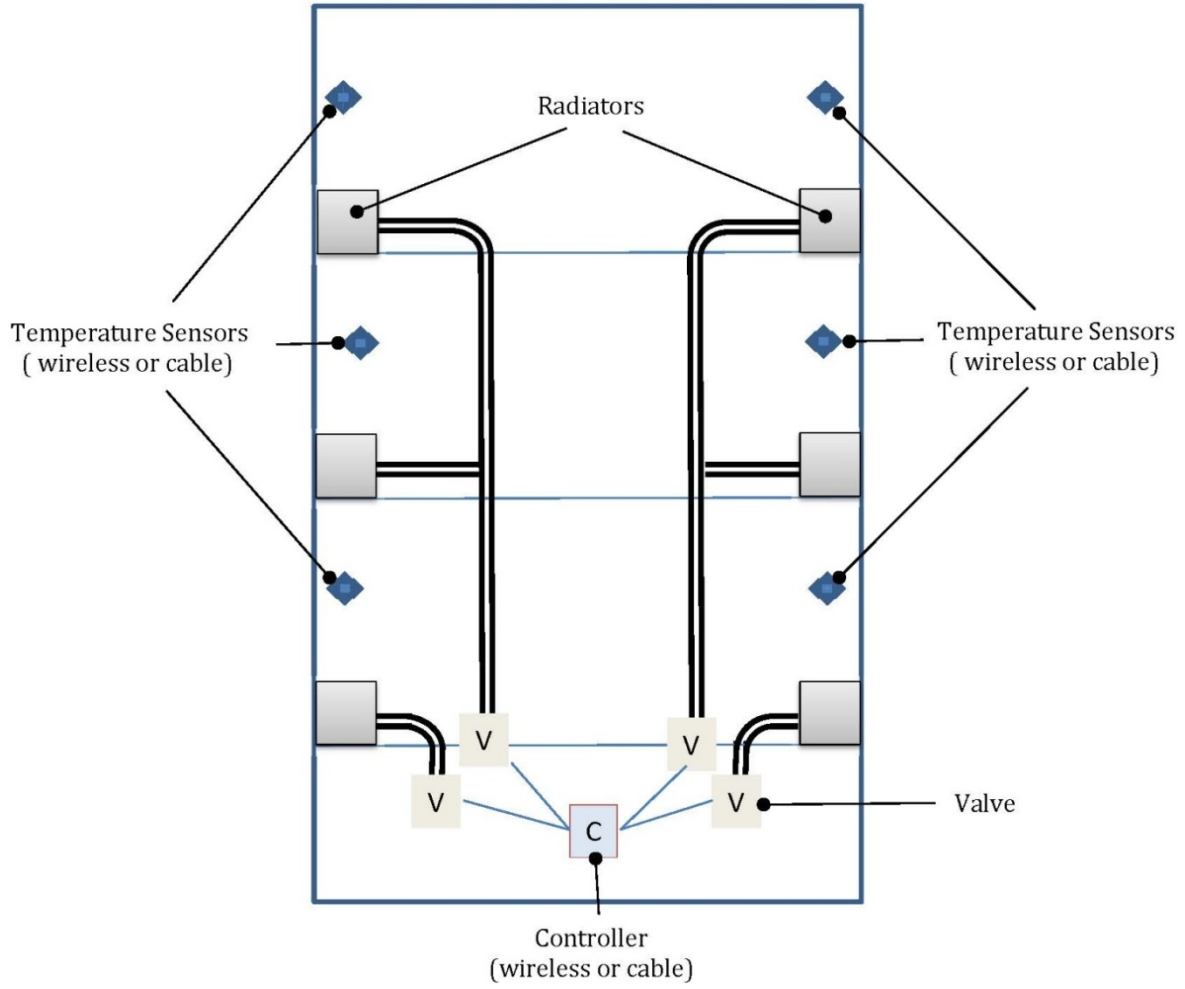

Figure 31. Diagram of local zone control scheme for Building 55

9 References

- Center for Energy and the Environment. (2006). *Outdoor Reset and Cutout Control*. Center for Energy and Environment: www.mncee.org/pdf/multifamily/outdreset_coutoutcon.pdf.
- CNT Energy. (2010). *Boiler Controls and Sensors*. Retrieved April 2011, from Energy Savers « CNT Energy: www.cntenergy.org/media/Boiler-Controls-Sensors.pdf.
- Gifford, H. (2004). *Choosing Thermostatic Radiator Valves*. American Boiler Manufacturer's Association.
- Hewett, M.J.; Peterson, G.A. (1984). "Measured Energy Savings From Outdoor Resets in Modern, Hydronically Heated Apartment Buildings." *Proceedings of the American Council for an Energy Efficient Economy 1984 Summer Study C*:135–152. Washington, D.C.: ACEEE.
- Liao, Z.; Dexter, A. (2004). "The Potential for Energy Saving in Heating Systems Through Improving Boiler Controls." *Energy and Buildings* 261–271.
- Liao, Z.; Dexter, A. (2005). "An Experimental Study on an Inferential Control Scheme for Optimising the Control of Boilers in Multi-Zone Heating System." *Energy and Buildings* 55–63.
- Peterson, G. (1986). "Multifamily Pilot Project Single Pipe Steam Balancing Hot Water Outdoor Reset." *Proceedings of the American Council for an Energy Efficient Economy 1986 Summer Study 1*:140–154. Washington, D.C.: ACEEE.
- U.S. Census Bureau. (2006). *American Housing Survey for the United States: 2005*. Washington D.C.: U.S. Government Printing Office.
- Massachusetts Department of Public Health. (2012, 06 10). MINIMUM STANDARDS OF FITNESS FOR HUMAN HABITATION. Retrieved 11 12, 2012, from The Official Website of the Commonwealth of Massachusetts: www.mass.gov/eohhs/docs/dph/regs/105cmr410.pdf#page=7.
- Regression for M&V: Reference Guide. (2011). Version 1.0. Prepared for Bonneville Power Administration: www.bpa.gov/energy/n/pdf/BPARRegression_forMV_ReferenceGuide.pdf.

buildingamerica.gov

U.S. DEPARTMENT OF
ENERGY | Energy Efficiency &
Renewable Energy

DOE/GO-102013-4009 • October 2013

Printed with a renewable-source ink on paper containing at least 50% wastepaper, including 10% post-consumer waste.