

BNL-60642
AD/RHIC-130
Informal Report

RHIC Warm-Bore Systems

Kimo M. Welch

July 1994

R H I C P R O J E C T

Brookhaven National Laboratory
Associated Universities, Inc.
Upton, NY 11973

Under Contract No. DE-AC02-76CH00016 with the
UNITED STATES DEPARTMENT OF ENERGY

THE RHIC WARM-BORE SYSTEMS

Kimo M. Welch

I. Introduction

Pressure profiles, in time, are calculated as a consequence of anticipated outgassing of various beam components (e.g., rf cavities, etc.) and warm-bore beam pipes. Gold beam lifetimes and transverse beam emittance growth are given for calculated average pressures.¹ Examples of undesirable warm-bore conditions are presented such as contaminated experimental beam pipes and warm-bore magnets (i.e., DX). These examples may prove instructive.

The methods used in making these calculations are presented in Section II. They are applicable to all linear systems. The calculations given apply to the RHIC accelerator (i.e., Fig. 1), and more specifically to warm-bore regions of the machine as represented in Fig. 2.

II. Method of Making Calculations

II.1. Long-Tube Equations with System Asymmetries.

The speed of a pump, S_p , can be expressed by the equation:²

$$S_p = S_{\max} (1 - P_0/P) \quad (1)$$

S_{\max} = the maximum pump speed, \mathcal{L}/s ,
 P_0 = the base pressure of the pump, Torr,
 and, P = the operating pressure, Torr,

and, we assume that for all cases examined, $P \gg P_0$.

Assume that a beam pipe has the dimensions as shown in Fig. 3A, and that the beam pipe is subtended by pumps. Assume that pump speed S_1 is zero, and that there is no outgassing from this pump. The pressure profile along the pipe which stems from uniform pipe outgassing is given by:³

$$P(x) = P_{p0} + (\pi q / 2kD^2) (2Lx - x^2), \quad (2)$$

x = some distance along the pipe, cm,
 D = pipe diameter, cm,
 L = pipe length, cm,
 q = unit outgassing, Torr- $\mathcal{L}/s\text{-cm}^2$,
 k = $12.1 (28.8/m)^{1/2}$,
 m = the molecular weight of the gas species,
 and, P_{p0} = the pressure at S_0 ,
 = $(q\pi DL)/S_0$.

Figure 3A.

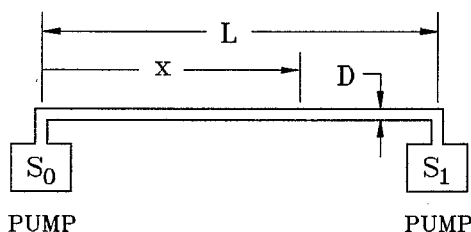

The average pressure in the pipe is merely:

$$\begin{aligned}
 P_{\text{avg.}} &= (1/L) \int_0^L P(x) dx \\
 &= \pi q [(DL/S_0) + (L^2/3kD^2)] \quad (3)
 \end{aligned}$$

If the first term in brackets in (3) is much smaller than the second term, the system is termed "conductance limited". This means that increasing the value of S_0 will be of little benefit in decreasing the average pressure. The opposite of conductance limited is called "speed limited". Examples of these limits will be clearly evident in some of the cases to be presented.

Assume now that $S_0 = S_1 \neq 0$. By inspection, it is evident that $dP/dx = 0$ at $x = L/2$, and one can easily solve for the average pressure. What if $S_0 \neq S_1$, and $S_0, S_1 \neq 0$? There is some place along the beam pipe, at $x = \ell$, where the net flux of gas is zero. Using (2) and setting $P(\ell) = P(L - \ell)$, the value of ℓ is found to be:

$$\ell = \frac{[(DL/S_1) + (L^2/2kD^2)]}{[(D/S_0) + (D/S_1) + (L/kD^2)]} \quad (4)$$

Knowing the value of ℓ permits one to calculate $P(x)$, P_{max} and $P_{\text{avg.}}$ over the length L .

II.2. More General Application

The more general case is illustrated in Fig. 3B. In this case there are three pumps positioned along three manifolds of conductances C_{01} , C_{12} , and C_{23} . There are four sources of outgassing along this manifold: outgassing from pipes of lengths L_{01} , L_{12} , L_{23} , and outgassing Q_2 , at location 2. Q_2 might be the total outgassing from some lumped source (e.g., an rf cavity).

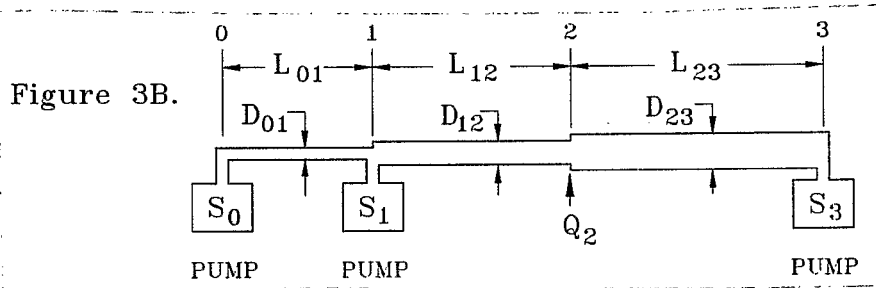

The principle of "linear superposition" must be invoked to solve this problem. This simply means that one calculates the pressure profiles along the entire manifold stemming from each outgassing source and then adds them to get the total pressure profile from all sources.

Let us first calculate the pressure profile stemming from L_{23} outgassing. Define S_{ij} as the pump speed at j stemming from all pumps from locations i through j . Clearly,

$$S_{02} = [S_{01} C_{12} / (S_{01} + C_{12})] \quad (5)$$

Knowing the speed produced at each end of pipe L_{23} , and the dimensions and outgassing rate of this pipe, (4) is invoked, and then (3) to find the average pressure along L_{23} . Using (4) an equivalent ℓ_{23} is found, from which is calculated that portion of gas from L_{23} which passes through L_{12} , to the left. One may then calculate the linear pressure profile along L_{12} , stemming from the outgassing of ℓ_{23} , defined as $Q(\ell_{23})$. The pressure at location 1 due to $Q(\ell_{23})$, is:

$$P_1(\ell_{23}) \triangleq Q(\ell_{23})/S_{01}$$

Gas from ℓ_{23} which is pumped by S_1 , is simply: $P_1(\ell_{23}) \times S_1$. The rest of the gas, $Q(\ell_{23}) - P_1(\ell_{23}) \times S_1$, courses on down L_{01} , etc.

Gas source Q_2 results in linear system pressure gradients. The pressure at location 2 as a function of Q_2 is:

$$P_2(Q_2) = Q_2 / (S_{02} + S_{32}).$$

Gas traveling to the left from Q_2 is simply $P_2(Q_2) \times S_{02}$, etc. The above covers all possible scenarios in a linear system. It is helpful to note that there is an exact correspondence between vacuum calculations and linear circuit theory.⁴

II.3. Simplification of Geometries.

There are times when it is not necessary to calculate pressures along each segment of a varying conductance, but rather to determine only the average pressure for the total system, assuming uniform outgassing rates. For example, assume a manifold with conductances C_{01} , C_{12} and C_{23} , of Fig. 3C, where dimensions L_{ij} , $D_{ij} \in C_{ij}$. We want to calculate an equivalent conductance, C_{03} , from which we may then calculate the desired average pressure. To do so, we merely solve the following two simultaneous equations:

$$C_{03} = C_{01} C_{12} C_{23} / (C_{01} C_{12} + C_{01} C_{23} + C_{12} C_{23}),$$

$$A_{03} = A_{01} + A_{12} + A_{23},$$

where, A_{ij} = the area of conductance C_{ij} .

We may make similar simplifications of branching circuits such as exist between magnets DX and D0, shown in Fig. 2. Proof of the system equivalency is left to the reader.

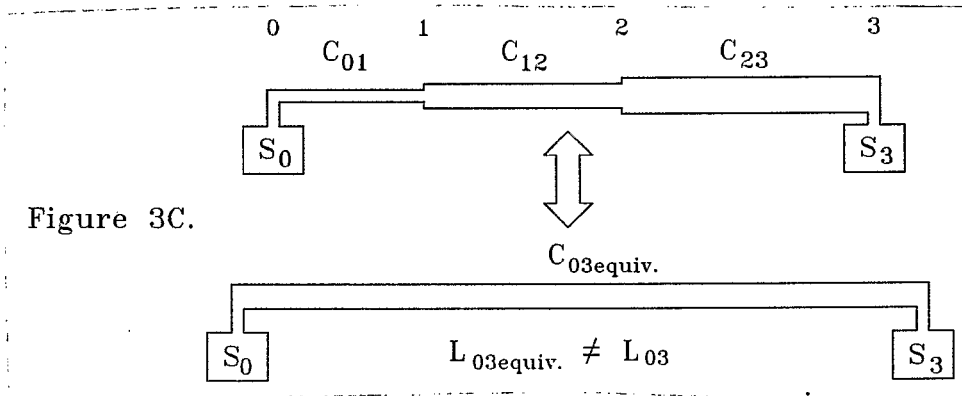

Figure 3C.

II.4. Optimum Warm-Bore Geometry.

Assume a system as depicted in Fig. 3A, where the spacing between the pumps is fixed. What is the optimum beam pipe diameter for a given pump size? Setting dP_{avg}/dD of (3) to zero, we find that:

$$D = (SL/3k)^{1/3}. \quad (6)$$

The warm-bore sections between the all-metal gate valves subtending the Q3 and Q4 magnets, are ~34 m in length (e.g., see Fig. 2). Set 34 m = 6x, place the first pump at x, and space each pump 2x apart. With 8 cm ϕ and 12.3 cm ϕ beam pipes, the optimum pump speeds would be:

GAS SPECIES	PIPE DIA. cm	APPROX. SPEED \mathcal{L}/s
H ₂	8.0	124
CO	8.0	33
H ₂	12.3	452
CO	12.3	121

Note that the beam pipe outgassing rate doesn't appear in (6). Also, the 8 cm ϕ beam pipe is more forgiving, in terms of required pump size, than the larger pipe with pumps spaced as indicated.

II.5. Definition of Component Relative Cleanliness

Component cleanliness is a relative term. Outgassing from stainless steel surfaces will be approximately as follows:

Table I. Representative Component Outgassing Rates

TREATMENT	Outgassing - 10^{-13} Torr- $\mathcal{L}/s\text{-cm}^2$			
	H ₂	H ₂ O	CO	CO ₂
Clean, Unbaked, 500 h pumping: *	76	114	38	23
After a 100 h, 100 C bake: **	75	3.1	3.4	0.6
After a 100 h, 200 C bake:	49	1.5	3.4	-
After a 300 C bakeout:	19	-	1.0	-
After a 925 C fire/300 C bake:	<1.9	-	<0.1	-
"Dirty" Model:	≥ 500	≥ 150	≥ 50	≥ 50

* Changing the temperature from 23 C to 35 C causes an increase of $\sim \times 3$ in pressures.³

** Changing the temperature from 23 C to 42 C causes pressure increase of $\sim \times 4$.³

This might be termed a "half baked" system.

Figure 4 shows the average warm-bore H₂ and CO pressures for the geometry discussed in Section II.4, and for given pump speeds and beam pipe outgassing rates. Referring to Table I, we note that use of pumps with speeds of $\sim 100 \mathcal{L}/s$ would not be adequate to meet the required average pressures (i.e., $\sim 3 \times 10^{-10}$ Torr) for systems baked only to 300 C. Therefore, either pumps of much greater speed must be used, or the beam pipes must be vacuum fired at 925 C, and then in situ baked. More will be mentioned in this regard. Examples of how outgassing rates similar to those shown in Table I impact on Au beam life times and emittance growth will be presented shortly.

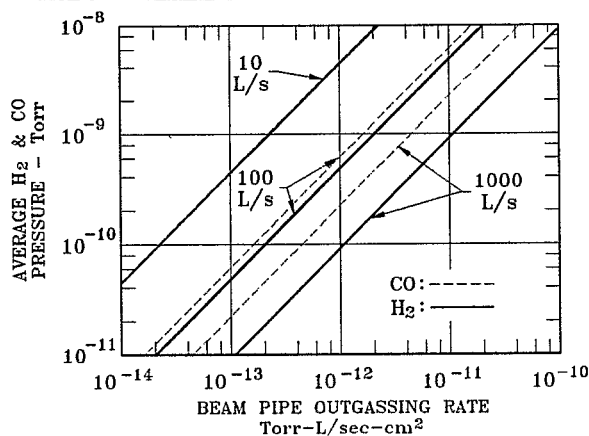

Figure 4. Average pressure in a beam pipe of 12.3 cm ϕ and for pumps of different speeds spaced at 13.3 m.

II.6. Oil Contamination

An example of a seriously contaminated system is one in which resides organic or silicone oils. The problem with such contamination is that, due to the Blears effect,⁵ one is unable to observe the existence of large partial pressures of these oils. However, they may be present and cause serious beam scattering or voltage breakdown problems in rf cavities. At room temperature one may eventually observe a "footprint" or characteristic fractionating pattern of the heavy oil molecules reaching some gas analyzer. Rarely, however, is the parent molecule observed at the analyzer.

CERN initially had problems stemming from oil backstreaming during roughing, and "dusting" in the SWCs (standing wave cavities).⁶ To avoid this, we recommend that all warm-bore equipment and manifolding in the RHIC system be sorption rough pumped. Also, when making repairs which require venting, these components should be vented to dry nitrogen.

It is now evident that one possible source of warm-bore organic contamination will be the cold-bores when at room temperature. It is not evident at this juncture how we will be able to keep the cold-bore pipes clean. Of course, when the cold-bore pipes are at a temperature of ~ 4.3 K, contamination therein will be strongly cryosorbed. Therefore, a requirement has been established wherein the valves isolating adjacent warm-bore and cold-bores will be automatically closed in the event the temperature of the cold-bore exceeds 20 K.

III. RF Cavity Outgassing

All calculations leading to anticipated outgassing of the SWCs (standing wave cavities) came from data provided in correspondences with H. Wahl and G. Englemann, of CERN. The pressure of the SWC was measured in the pump during cavity age-in. Discussion of cavity processing is given in reference 6. Briefly, the cavities are vacuum baked at ~ 140 C, vented to dry N_2 , installed in the SPS ring, and evacuated and rf aged. The pumps comprise combination TSP and SIP pumping. Pump pressure, in time, is shown in Fig. 5. Data are extrapolated beyond ~ 300 h.

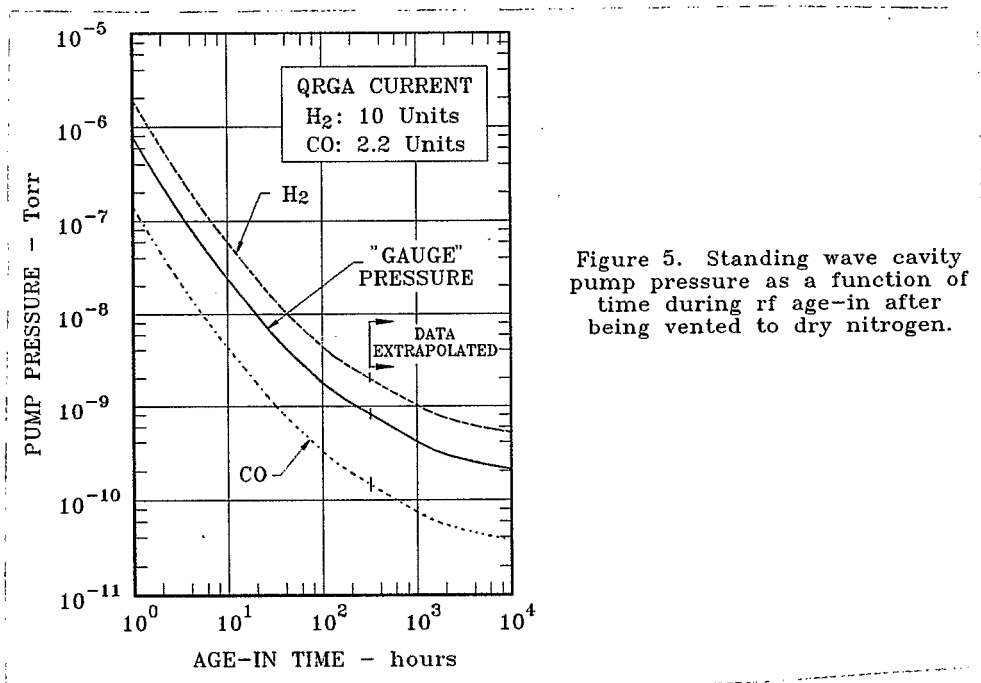

Figure 5. Standing wave cavity pump pressure as a function of time during rf age-in after being vented to dry nitrogen.

The inset in Fig. 5 shows the proportions of amu 2 and 28 ~ 28 h into the age-in cycle. It was assumed that these proportions remained the same in time. The amu 12 and 14 peaks suggested that the amu 28 peak was mostly CO. Brazed-in aperture plates serve as rf shields separ-

ating the SWCs from the pumps. The conductances of these aperture plates for CO and H₂ are 474 L/s and 1700 L/s respectively. A drawing of the pumps was obtained from the vendor who supplied the pumps to CERN. The TSP pumping surface area was determined from these drawings. Knowing this surface area, an intrinsic pump speed of ~6000 L/s and ~19,000 L/s is calculated for H₂ and CO respectively.⁷ From this and the data in Fig. 5, the pressure in time in a blanked-off SWC (i.e., with no other auxiliary pumping) was calculated, and is shown in Fig. 6. All subsequent calculations stem from rf cavity gas throughputs based on these data.

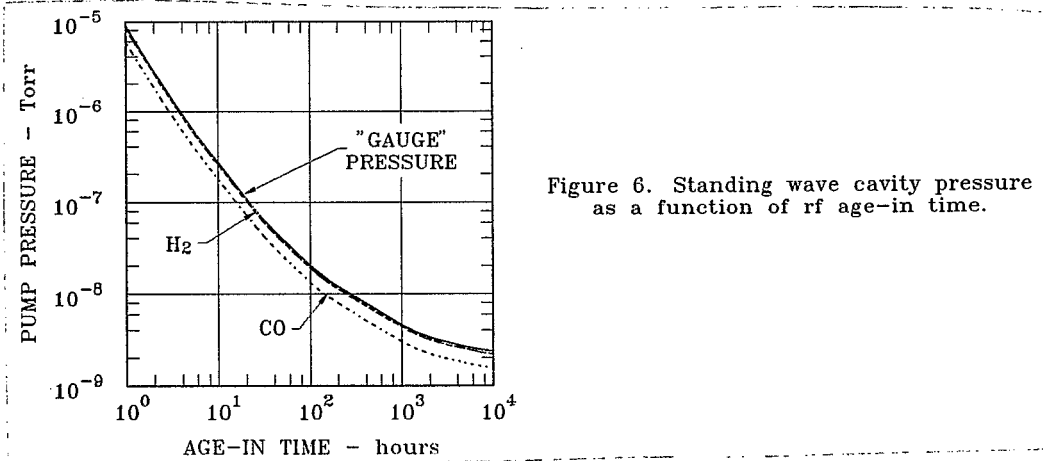

Figure 6. Standing wave cavity pressure as a function of rf age-in time.

The surface area of the RHIC accelerating cavities (ACs) is ~×3.2 that of the SWCs. Also, whereas the SWCs are constructed of brazed OFHC Cu, the accelerating cavities will probably be constructed of Cu, roll-bonded to mild steel, or Cu plated mild steel. It is reasonable to assume that the outgassing of the ACs will be ≥×3.2 that of the SWCs. It was assumed in calculations involving the ACs that the apertures separating the cavities from their respective pumps were sized identical to those of the SWCs.

IV. Experimental Areas without RF Cavities

IV.1. The Boundary Conditions

Cases explored included: 1) experimental beam pipes (EBPs) of varying beam pipe geometries; 2) the consequences of "half baked" and "dirty" EBPs; 3) the consequences "half baked" and "dirty" DX magnet beam pipes; and, 4) average pressures with pumps of specified speeds and locations. These results are applicable to all experimental areas.

The system configuration is schematically represented in the upper left hand corner of Table IIa. Conductance C_{ei} is the equivalent conductance of a DX magnet combined with the two beam pipes branching from the DX magnet into adjacent D0 magnets. Speed S_Q , shown in this figure, represents the pumping speed of the cold-bores of the D0 magnets. This speed varies, of course, depending on the gas species. Though the vacuum WBS includes only the use of the two pumps S, the benefit of additional pumps S_C , S_D and S_e , of varying speeds, was explored. The speed of the S pumps is always that of the other nonzero pump speeds of the respective groupings.

The length of the EBP, L_x , and its diameter, D_x were also varied, and with this variation the length of L_3 was correspondingly varied.

Calculations were made for varying outgassing rates of the EBP, C_{ei} equivalent, and the stainless steel beam pipe. The various outgassing rates may be referenced to conditions described in Table I. Though all stainless steel beam pipes may be vacuum fired at 925 C, as in the next to last case in Table I, it was assumed that EBPs, because of the manner in which they are fabricated, may only be baked to 300 C.

Results of the 39 cases calculated are given in Tables IIb and IIc. For each case, calculations were made for only CO and H₂ outgassing rates. In all cases to be presented, the partial pressures of the heavier gases such as H₂O and CO₂ were assumed to be CO. The average CO and H₂ pressures in the actual EBP and from D0 to D0, were calculated. The partial pressures were combined in what is termed an equivalent H₂ pressure, where this comprised the sum of the H₂ partial pressure and $\times 1.6$ that of the CO partial pressure. From this results beam life times were calculated assuming either: 1) conditions were applicable to one experimental area and the rest of the warm-bore had average pressures of 5×10^{-10} Torr; or, 2) results were applicable to all experimental areas. Though calculated, the partial pressures of CO and H₂ are not shown in Tables IIb and IIc. Rather, merely their sums and the equivalent H₂ pressure.

IV.2. Some Conclusions

A. Case #1 & #2 are out of specification for the machine, whereas Case #3 is well within specification. (Note: because of beam component outgassing tolerances, the rest of the warm-bore must have an average pressure of $\sim 2 \times 10^{-10}$ Torr.)

B. Noted changes in the length and diameter of the EBP resulted in an improvement of at best only $\sim \times 2.5$ in the EBP average pressure, when not speed limited (e.g., Case #3 vs. #6; #9 vs. #12.; or, #19 vs. #22), and absent a dirty EBP.

C. Changing the aspect ratio of the EBP is of little benefit with the use of four 100 \mathcal{L}/s pumps. This implies being speed limited (i.e., Cases #13-14 vs. #16-17).

D. Though results are not shown, the pump S_C had little effect on average pressures.

E. Cases #8 & #11 show that we may avoid vacuum firing all stainless steel beam pipes at 925 C if we increase the speed of the S pumps from 100 \mathcal{L}/s to 1000 \mathcal{L}/s . This implies that we revert to the use of TSP pumps rather than NEG's. Obtaining this same results by increasing the number rather than size of pumps, as in Case #14, is fiscally unattractive.

F. Cases #1 & #2 vs. #7 & #8 are good examples of a conductance limited system. Though the speed of the pumps was increased by $\times 10$, the average pressure of the system decreased by only $\sim \times 2$.

G. Cases #24-27 are examples of a dirty EBPs. For all of these cases the problem can only be remedied by the use of additional pumps and changing the EBP aspect ratio (i.e., Cases #24 vs. #27). For both Cases #24 & #25, the EBP partial pressures of H₂ vs. CO are in proportions 0.59:1. Even in Case #27, they are in the proportion 1.5:1.

H. Cases #28-31 are examples of half-baked EBPs. That is, they have been baked at ~ 100 C for 100 h. None of these cases provide average pressures within the specification, suggesting the more favorable EBP aspect ratio is required.

I. Cases #32-39 graphically illustrate the need for the thorough baking of the DX and DX-D0 beam pipes. Again, Cases #32-35 are for dirty DX magnets, whereas Cases #36-39 are for half-baked DX magnets. Neglecting, effects on beam life times, detector noise from gas scattering would be prohibitively high under these circumstances. Also, it could prove necessary for vacuum controllers to be remotely located because of high radiation stemming from beam collisions with gas.⁸

V. 4:00 O'clock Experimental Area, with SWCs

V.1. Boundary Conditions

The system configuration is schematically represented in Fig. 7 and at the top of Table IIIa. Again, conductances C_{ei} are composites of the DX magnet bore and the two beam pipes leading from the DX to D0 magnets. In this case, conductance C_X is a composite of three beam pipes, of varying lengths and diameters, associated with the Brahm's detector. The actual detector beam pipe has a length and diameter of L_3 and D_3 respectively. In these calculations, pumps of speeds S and S_2 are the sputter-ion pumps normally subtending all experimental areas. Pump S_1 is an alternate pump used to bracket the SWCs to reduce pressure in the area of the detector.

Calculated conductances from cavity to cavity and cavity to beam pipes are based on a dimensional analysis of the SWCs. The speed delivered to the cavities by each attending pump, S_{rf} is 462 \mathcal{L}/s and 1367 \mathcal{L}/s for CO and H_2 respectively. The rest of the terms in this table have been previously defined.

Figure 7. PRESSURE PROFILE MODEL FOR THE 4:00 EXPERIMENT BRAHMS

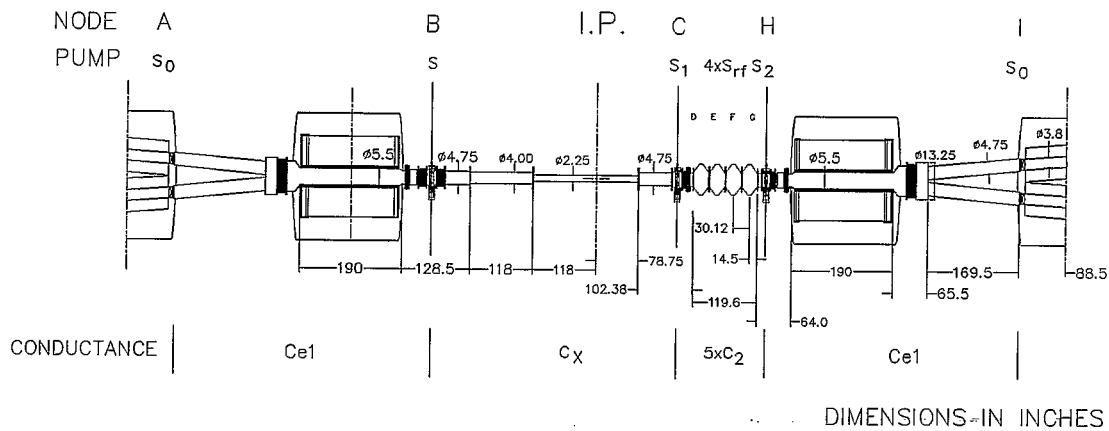

D. WEISS
04/07/84
ACAD/DRAWFILE/DX-00/PPR04-A.DWG

V.2. Steady-State Results

Table IIIb summarizes results for variables including: 1) pump speeds and locations; 2) cavity outgassing rates; and, 3) EBP dimensions. It was assumed that the EBP in all cases was clean, and had been baked at 300 C. The first 12 cases shown assume SWC outgassing rates comparable to that noted after 280 h of age-in. Case #13 is the cavity outgassing rate expected after $>10^4$ h of cavity age-in, whereas Case #16 is after ~ 40 h of cavity age-in.

The average pressure in the experimental beam pipe, and the total average pressure up to the entrances of the D0 magnets subtending each end of the experimental region are given. Again, CO and H_2 pressures are combined for these areas, and an equivalent H_2 pressure was used to calculate beam life times.

Pumps with speeds of 100 \mathcal{L}/s correspond to NEG/SIP combination pumps at $\sim 10^{-10}$ Torr (Case #1-6); whereas pumps of $\sim 10^3$ \mathcal{L}/s are TSP/SIP combination pumps (Case #7-16); and, pumps of speeds of $\sim 10^4$ \mathcal{L}/s correspond to 100 cm long, 2 K, cold-bore cryopumps (Case #17-21).

The throughput of H_2 stemming from cavity and beam pipe outgassing, and which enters the apertures of the D0 magnets, has also been calculated in each case. Consequences of this H_2 throughput have been reported elsewhere,⁹ and will be the subject of another paper.

V.3. Conclusions on Steady-State Results

- A. Cases #1-16 are out of the pressure specification range.
- B. After age-in of the cavities for over a year (i.e., Case #13), the average pressure from D0 to D0 exceeds the specification by $\times 1.75$.
- C. Even when bracketing the cavities with 10^4 \mathcal{L}/s cryopumps, it takes better than a year to achieve the average pressure of $\sim 5 \times 10^{-10}$ Torr (e.g., Case #17).
- D. Use of the additional pump at S_1 improves the pressure performance by about 60% (e.g., Case #7 vs. #8).
- E. TSP/SIP combination pumping will be required, at a minimum as a consequence of rf cavity outgassing.
- F. There is little average pressure difference for $S_1 \neq 0$, and $S_2 = 0$ vs. $S_1 = 0$ and $S_2 \neq 0$ (i.e., Case #9a vs. #8). Therefore, one might eliminate S_2 , keep S_1 and squeeze the rf cavities closer to the DX magnet. This will afford more room for shielding of the Brahms detector from the cavities.
- G. However, the use of pump S_1 vs. S_2 reduces the average EBP pressure by $> \times 2$.
- H. Also, the use of both pumps S_1 and S_2 results in an improvement in average pressure from D0 to D0 of $\sim \times 1.5$, when not speed limited.

V.4. Transients Pressure Performance

Using the data of Fig. 5, transient outgassing calculations were made. These data are shown in Table IIIc. In all cases 1000 \mathcal{L}/s TSP/SIP combination pumps were used. These data graphically demonstrate the need for very high reliability rf systems in the RHIC. That is, every time the cavities must be vented for repairs, we "start from scratch" in terms of cavity outgassing. Note also that the data in Tables IIIb and IIIc are for clean, hydrocarbon-free cavities which have been processed according to the CERN recipe.

VI. RF Cavities Between Q3 & Q4 Magnets Near 4:00 O'clock

VI.1. Boundary Conditions

Each beam pipe of this warm-bore region accommodates five rf cavities: two ACs and three SWCs. A schematic representation of this system is given in Fig. 8. The SWCs are located at positions d, f and h, whereas the ACs are located at positions l and m. In this model, Q_{rf} represents the total outgassing rate from each of the SWCs; Q_4 , total outgassing from each of the ACs; Q_2 , total outgassing from each of the AC tuners; and, q_1 outgassing per unit area from the AC drift tubes. C_1 , C_2 and C_3 represent the conductances of the interconnecting stainless steel beam pipes; C_T is the longitudinal conductance of the tuners; C_{dt} the conductance of the drift tubes of the two cavities at locations l and m; and, C_g , the conductances leading from the ACs to the beam pipe. Though the model permits investigation of the effects of the use of o-rings in the PoP AC tuners, it was assumed that the tuner assemblies (and AC drift tubes) outgassed at rates comparable to that of the SS beam pipes. This, however, is probably optimistic by $\times 10$ -50.

Because the drift tubes of the ACs extend beyond the ends of the cavity walls and into the regions of the tuners, the ACs in effect constitute vacuum volumes off-line from the beam tube. From a vacuum standpoint, pressures at locations k and n are of interest in being at the accelerating gaps of the ACs.

Figure 8. Warm-bore vacuum system configuration between magnets Q3 and Q4 near 4:00 O'clock.

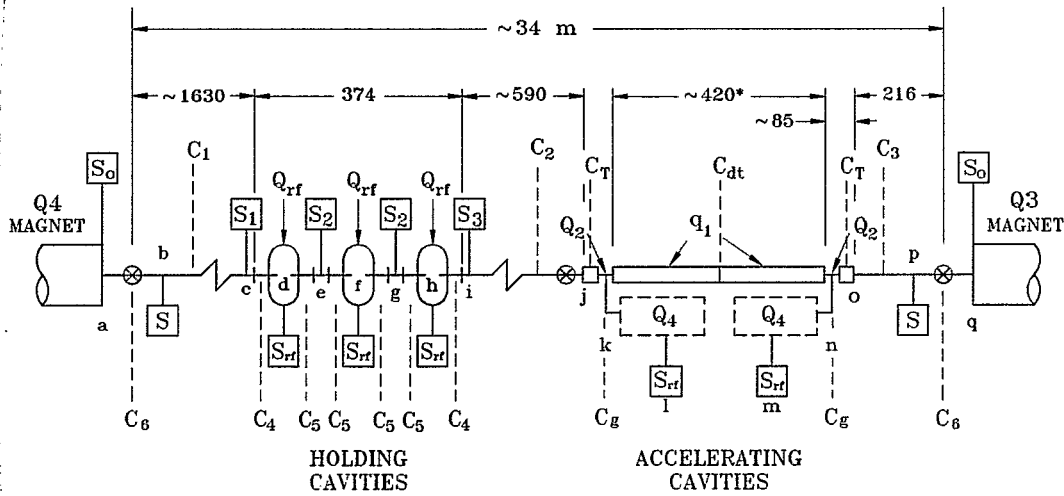

Unlike previous cases, in this model the SWCs have been spaced at a distance λ rather than $\lambda/2$ to facilitate placement of pumps of speed S_2 between each SWC. By setting $Q_4 = 0$, we may then evaluate the benefit of the use of pumps similar to S_2 at the 4:00 O'clock installation of SWCs, as well as between Q3 and Q4. In that the SWCs operate for extended periods, it was thought prudent to study the feasibility of bracketing the SWCs, rather than the ACs, with pumps S_1 and S_3 .

VI.2. Case Studies

Case permutations and combinations are numerous. We know that the ACs and SWCs operate at different times. The ACs will operate for about a minute during beam acceleration and then be switched off as the SWCs are turned on. Though we don't know what the pumpdown response times of the ACs will be on turn-off, we can assume that, absent thermal effects, the ACs will pump down in a matter of minutes after the SWCs are turned on.

The model developed has great flexibility for future studies. However, only a total of 42 cases were investigated (84 with SWCs and ACs alternately energized). The various cases explored are listed in Table IV.

Table IV. CASE STUDIES OF RF CAVITIES LOCATED BETWEEN MAGNETS Q3 & Q4 NEAR THE 4:00 O'CLOCK REGION

CASES 1-7:

$$\begin{aligned}
 &P(t) \text{ for } 1\text{-}10^4 \text{ h (1, 10, 28, 100, 280, } 10^3, \text{ and } 10^4 \text{ h),} \\
 &S_i = 1000 \text{ L/s } \forall i, \\
 &Q_4 = 3.2 Q_{rf} \\
 &q_1 = q_0 = 1.9 \times 10^{-12} \text{ Torr-L/s cm}^2 \text{ H}_2, 10^{-13} \text{ Torr-L/s cm}^2 \text{ CO,} \\
 &Q_2 = q_0 A_2 \text{ (i.e., } A_2 \text{ is the surface area of the tuners)}
 \end{aligned}$$

CASES 8-14: Same as Cases 1-7 except $Q_4 = Q_{rf}$.

CASES 15-21: Same as Cases 1-7 except $S_2 = 0$.

CASES 22-28: Same as Cases 1-7 except $S_2, S_3 = 0$.

CASES 29-35: Same as Cases 8-14 except $S_2, S_3 = 0$.

Table IV, (Continued)

CASE 36: Half-baked AC cavities, drift tubes and tuners (q_1):

$$7.6 \times 10^{-12} \text{ Torr-L/s cm}^2 \text{ H}_2,$$

$$1.75 \times 10^{-11} \text{ Torr-L/s cm}^2 \text{ CO},$$

$$1000 \text{ h CERN } Q_{\text{rf}} \text{ data},$$

$$Q_4 = 6 \times 10^4 q_1$$

$$S_3 = 1000 \text{ L/s}, S_2 = 0.$$

CASE 37: Same as Case 36 except $Q_4 = Q_{\text{rf}}$.

CASE 38: Same as Case 36 except $S_3 = 0 \text{ L/s}$.

CASE 39: Same as Case 37 except $S_3 = 0 \text{ L/s}$.

CASE 40: Same as Case 8-14 except $S_2, S_3 = 0; S, S_1 = 100$.

CASE 41: Same as Case 1-7 except $S_2, S_3 = 0; S, S_1 = 100$.

CASE 42: Same as Cases 1-7 except $S_1, S_2 = 0$.

VI.2. Steady-State Results

Table Va shows an example of the outcome of one of the 42 calculations. Local pumping speeds, using the previously noted subscripts, and outgassing rates are listed to the left, dimensional variables to the center, and results of the calculations to the right of this table.

To simplify interpretation of results of the calculations, let us first look at results to be expected after a 1000 h age-in of the SWCs and ACs. From this we may draw some general conclusions about an optimum system configuration. Then, we can explore the consequences of changing other parameters in this context. Note that age-in of the SWCs for 1000 h implies nothing about the probable age-in time on the ACs. However, we will assume each cavity type was aged 1000 h.

One thousand hour results are shown in Tables Vb. and Vc. Table Vb. shows vacuum performance for various configurations with the ACs turned off and the SWCs turned on, whereas Table Vc., vice versa. Average pressures are given as a consequence of the SWCs, ACs, AC tuners and drift tubes, and stainless steel beam pipes. The pressure noted at the AC gap is the maximum pressure of the two gaps, and is given for when both the SWCs and ACs are turned on. Again, the H_2 throughputs into the cold-bores were calculated for all cases. From these two tables some of the conclusions reached, regarding average H_2 equivalent pressures between the Q3 and Q4 magnets, are:

SWCs On ACs Off (Table Vb.)

- A. The average pressure with the maximum number of pumps in place between the Q3 and Q4 magnets is $\sim 1.3 \times 10^{-9}$ Torr (i.e., Case #6).
- B. The use of pumps S_2 between the SWCs has the effect of reducing the total average pressure with SWCs operating by only $\sim 24\%$ (i.e., Case #6 vs. #20). They would be no more effective at the 4:00 o'clock region.
- C. Pump S_3 is beneficial in "bracketing" the SWCs, its presence resulting in a decrease in average pressure (without the S_2 pumps) of $\sim \times 2$ (i.e., Case #20 vs. #27).
- D. The vacuum WBS calls for the use of three independent pumps in each Q3-Q4 warm-bore section. The use of two S and one S_3 is slightly more beneficial than two S and one S_1 pumps (i.e., Case #27 vs. #42).
- E. There is a 50% improvement in average pressure as a consequence of 1000 \mathcal{L}/s vs. 100 \mathcal{L}/s pumps at S and S_1 (i.e., Case #27 vs. #40).

SWCs Off ACs On (Table Vc.)

F. Average pressure with the maximum number of pumps located between Q3 and Q4 is $\sim 1.7 \times 10^{-8}$ Torr (i.e., Case #6). This is considerably out of specification.

G. Pumps S_2 and S_3 are of little benefit with pump S_1 (i.e., Case #7 vs. #26).

H. Use of pump S_3 is slightly more beneficial than pump S_1 , (i.e., Case #27 vs. #42).

I. There is little improvement in average pressure as a consequence of 1000 \mathcal{L}/s vs. 100 \mathcal{L}/s pumps at S and S_1 .

From the above we conclude that: 1) the S_2 pumps are of little benefit; 2) it would be advisable to bracket the SWCs with the S_1 and S_3 pumps; 3) assuming we are able to process the SWCs with the same facility as the CERN staff still leads to pressures exceeding specification after 1000 h of operation; 4) Outgassing from the ACs could prove troubling if there are thermal effects in same after they are deenergized.

VI.4. Transients Pressure Performance

The above findings suggest that pumps S_2 are of no benefit, but that the preferred configuration should include pumps S_1 and S_3 . Also, these pumps should be TSP/SIP combinations pumps. Cases #15 - #21 treat outgassing in time for this configuration. Table Vd. gives data with only the SWCs on and Table Ve. with only the ACs on. It is recommended that all-metal, rf shielded gate valves be located between the three SWCs and two ACs in each ring (i.e., between positions i and j of Fig. 8.). This will make it possible to do maintenance on either the SWCs or the ACs without having to vent the entire section between magnets Q3 and Q4.

VII. Summary of Some Findings

VII.1 Boundary Conditions

Some unknowns remain which preclude one accurately modeling the entire RHIC warm-bore system. These include partial pressures of species in: 1) the injection septa and kickers; 2) the beam dumps and associated kickers; and, 3) the beam scrapers.

Preliminary outgassing results of the coated, Al_2O_3 injection kicker beam pipes suggest that it is reasonable to expect them to operate well within the pressure specification. Therefore, their pressure contributions will be neglected in the summary findings.

In constructing a summary model, it will be assumed that there will be no pressure "bumps" at the various beam scrapers, and that they will operate within the specification. Further, it will be assumed that the average H_2 equivalent pressure in the 10:00 o'clock region of the beam dumps will be 2×10^{-9} Torr H_2 equivalent. It is also assumed that the diameter of the EBPs is ~ 5.9 cm and their lengths 500 cm.

Only the 1000 \mathcal{L}/s pump speed data are presented in the summary analysis. This, of course, excludes pumps directly attending the rf cavities. Excluding the 4:00 o'clock region, each experimental area is subtended by two pumps (i.e., see Table IIa). At the 4:00 o'clock region it is assumed that the SWCs are bracketed by pumps S_1 and S_2 , and a third pump, S, is located at the other end of the experimental beam pipe (i.e., see Fig. 7). Two pumps S, and pumps S_1 and S_3 are used in the rf region between Q4 and Q3 (i.e., see Fig. 8).

VII.2 RHIC Ring Summary Case Result

With the above boundary conditions, fifteen summary case studies were calculated. The variables of these cases are given in Table VI. Gold beam emittance growth rates and life times were calculated for each of the 15 cases. The case numbers are listed at the top of the table

whereas the numbers of the figures showing the associated the beam emittance growth and life results are listed at the bottom of the table.

Results of Case #1 are first shown in Fig. 9 where emittance growth and beam life are given for conditions of Table VI., and for average cold-bore H_2 pressures of both 10^{-11} and 10^{-12} Torr. For comparison purposes, the 10^{-11} Torr data overlay all subsequent figures.

Case #2, #5, #8, etc. involve the combined outgassing from the operation of all SWCs and ACs. It was assumed that the ACs were aged at one-tenth the time of the SWCs. These data would be "instantaneous" growth and life values, as the simultaneous operation of both SWCs and ACs need be very brief. Neglecting possible ACs thermal effects, one e-fold in AC cavity pumpdown occurs in only three seconds.

In Case #3, #6, #9, etc., it is assumed that the four SWCs located at 4:00 o'clock have been aged for 10^4 h, but that the three SWCs between magnets Q3 and Q4 near 4:00 o'clock were aged in starting "from scratch". Such a scenario might occur in the event that maintenance required venting of the latter cavities to N_2 .

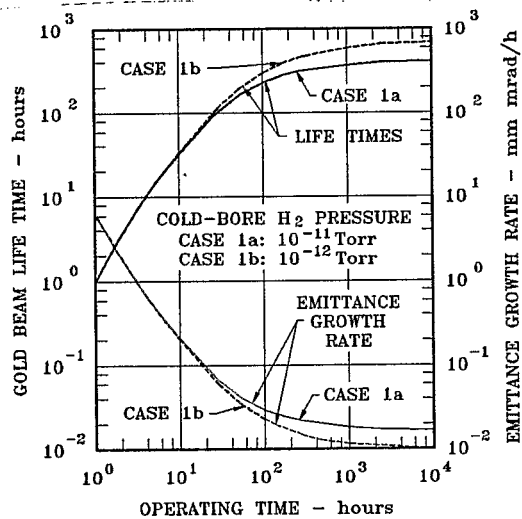

Figure 9. RHIC gold beam life times and emittances for operating scenarios and resultant pressures.
BASE-LINE IDEAL CASE

Acknowledgements

I thank Dan Weiss for his work in independently verifying the model for the 4:00 o'clock region, and for preparation of Fig. 7. Also, I thank the entire vacuum group for their consideration of my time during this work.

References

- ¹ M.J. Rhoades-Brown and M. A. Harrison, "Vacuum Requirements for RHIC" Informal Report, BNL No. BNL-47070, AD/RHIC-106, December 1991.
- ² K.M. Welch, Capture Pumping Technology, An Introduction, (Pergamon Press, Oxford, Sept. 1991), p. 36.
- ³ K.M. Welch, "The pressure profile in a long outgassing vacuum tube", *Vacuum* **23**(8), 271(1973).
- ⁴ K.M. Welch, Reference 2, pp. 31-32.
- ⁵ J. Blears, Proc. Roy. Soc., London A188, 62(1947).
- ⁶ K.M. Welch, CERN Trip Report 9207768, 3(1993).
- ⁷ K.M. Welch, Reference 2, p 200.
- ⁸ A.J. Stevens, "Radiation Levels at Floor Level from Local Beam Loss in RHIC", RHIC Tech. Note #AD/RHIC/RD-27, October 1991.
- ⁹ J.P. Hobson, K.M. Welch, "Time-dependent helium and hydrogen pressure profiles in a long, cryogenically cooled tube, pumped at periodic intervals", *J. Vac. Sci. Technol.* **A11**(4), 1566(1993).

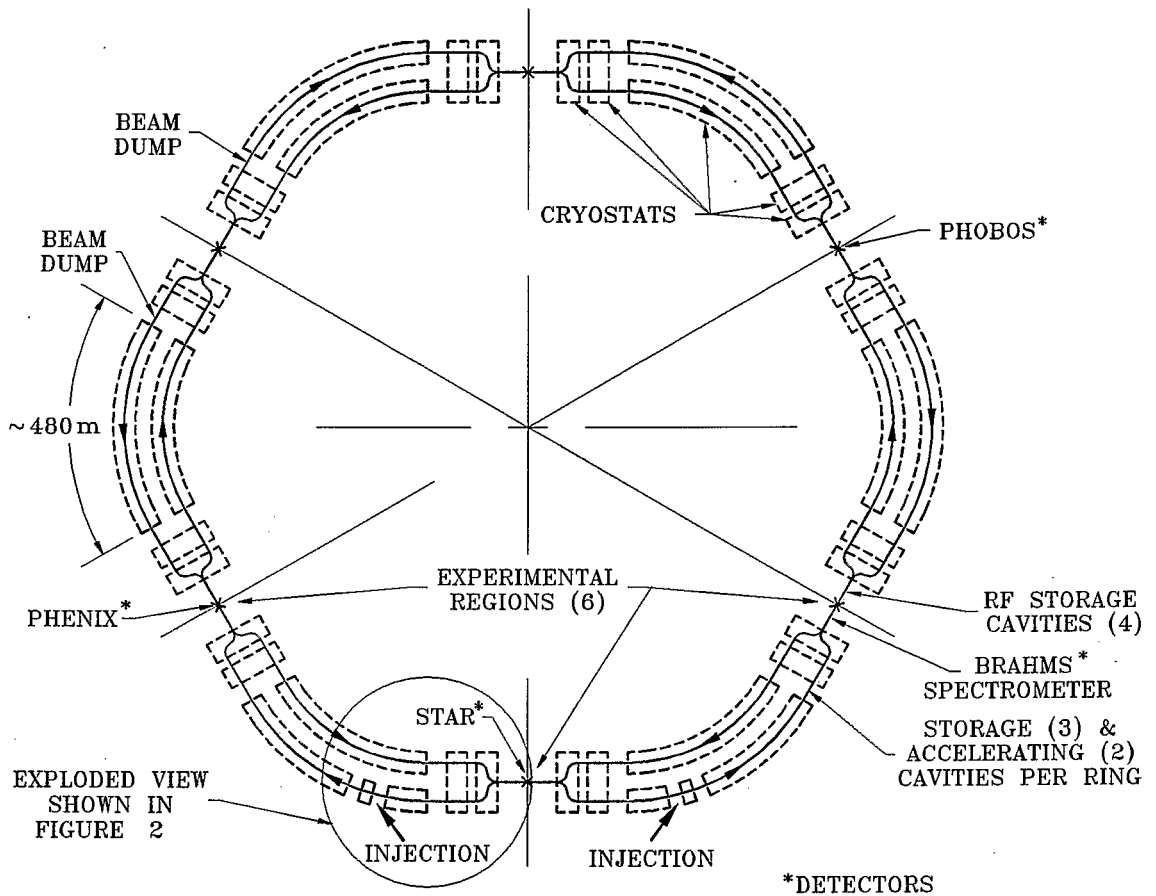

Figure 1. The Brookhaven Relativistic Heavy Ion Collider.

"ringstuf"
 0.4=1; 1.5,2
 Kimo M. Welch
 May 31, 1994

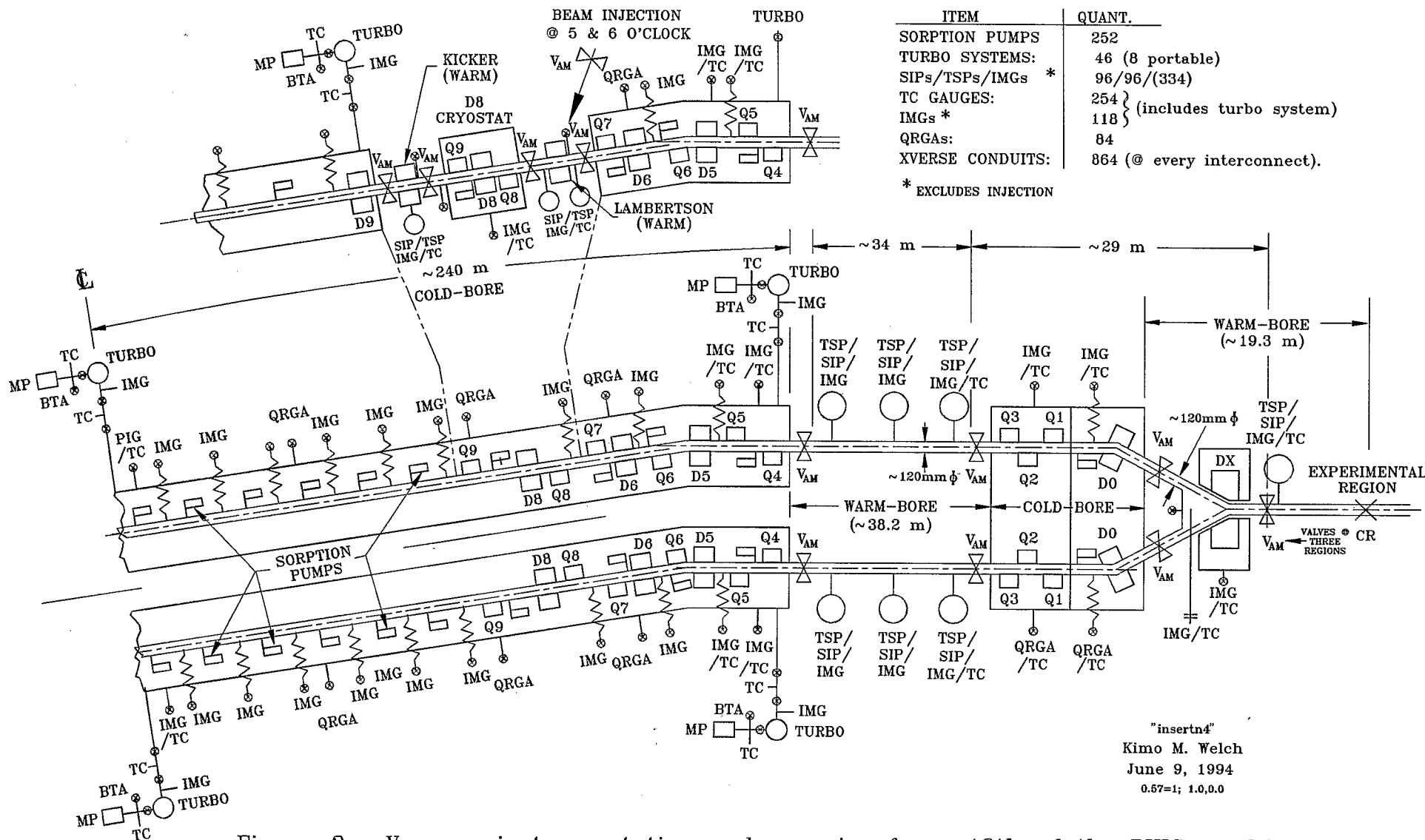
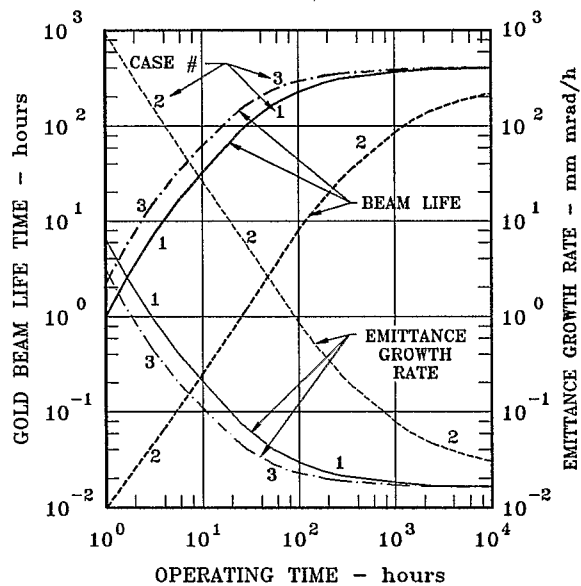

Figure 2. Vacuum instrumentation and pumping for a 12th of the RHIC machine.

Figure 10. RHIC gold beam life times and emittances for operating scenarios and resultant pressures.



FIVE EXPERIMENTAL REGIONS (ALL CASES):

P_{avg} , H₂ EQUIV. PRESSURE IN 5 D0-D0 REGIONS: $\sim 3 \times 10^{-10}$ Torr.

4:00 O'CLOCK REGION:

CASE 1&2: SWCs OUTGASSING AS $f(t)$ FROM START.

CASE 3: SWCs OUTGASSING @ 10,000 h AGE-IN RATE.

Q3-Q4 RF SYSTEMS:

CASES 1&3: SWCs OUTGASSING AS $f(t)$ FROM START.

CASE 2: ACs OUTGASSING & AGED AT 1/10 TIME OF SWCs.

10:00 O'CLOCK BEAM DUMP REGION:

P_{avg} , H₂ EQUIV. PRESSURE @ BEAM DUMP AREAS 2×10^{-9} Torr.

Figure 11. RHIC gold beam life times and emittances for operating scenarios and resultant pressures.

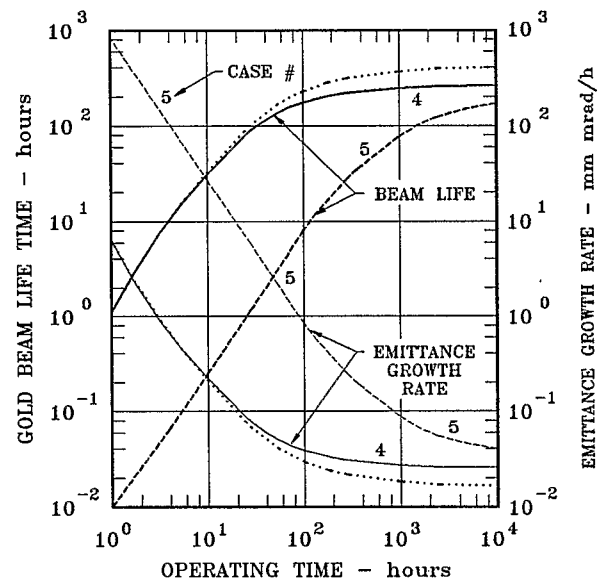

IDEAL CASE: -----

FIVE EXPERIMENTAL REGIONS (ALL CASES):

"HALF-BAKED" EXPERIMENTAL BEAM PIPES.

4:00 O'CLOCK REGION:

CASE 4&5: SWCs OUTGASSING AS $f(t)$ FROM START.

Q3-Q4 RF SYSTEMS:

CASE 4: SWCs OUTGASSING AS $f(t)$ FROM START.

CASE 5: ACs OUTGASSING & AGED AT 1/10 TIME OF SWCs.

10:00 O'CLOCK BEAM DUMP REGION:

P_{avg} , H₂ EQUIV. PRESSURE @ BEAM DUMP AREAS 2×10^{-9} Torr.

Figure 12. RHIC gold beam life times and emittances for operating scenarios and resultant pressures.

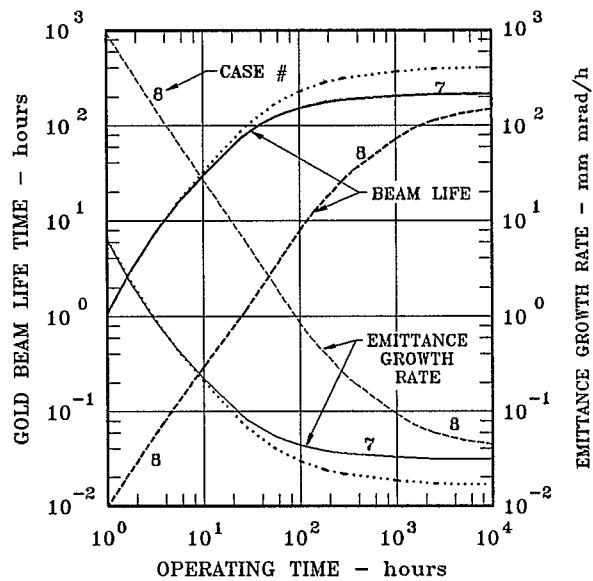

IDEAL CASE:

FIVE EXPERIMENTAL REGIONS (ALL CASES):

"HALF-BAKED" DX MAGNET WARM-BORE TUBES.

4:00 O'CLOCK REGION:

CASE 7&8 SWCs OUTGASSING AS $f(t)$ FROM START.

Q3-Q4 RF SYSTEMS:

CASE 7: SWCs OUTGASSING AS $f(t)$ FROM START.

CASE 8: ACs OUTGASSING & AGED AT 1/10 TIME OF SWCs.

10:00 O'CLOCK BEAM DUMP REGION:

$P_{avg. H_2}$ EQUIV. PRESSURE @ BEAM DUMP AREAS 2×10^{-9} Torr.

Figure 13. RHIC gold beam life times and emittances for operating scenarios and resultant pressures.

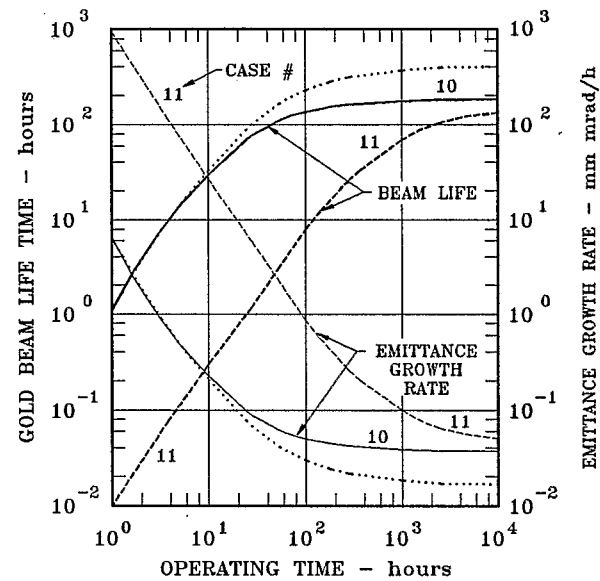

IDEAL CASE:

FIVE EXPERIMENTAL REGIONS (ALL CASES):

"HALF-BAKED" EXPERIMENTAL BEAM PIPES AND DX BEAM TUBES.

4:00 O'CLOCK REGION:

CASE 10&11: SWCs OUTGASSING AS $f(t)$ FROM START.

Q3-Q4 RF SYSTEMS:

CASE 10: SWCs OUTGASSING AS $f(t)$ FROM START.

CASE 11: ACs OUTGASSING & AGED AT 1/10 TIME OF SWCs.

10:00 O'CLOCK BEAM DUMP REGION:

$P_{avg. H_2}$ EQUIV. PRESSURE @ BEAM DUMP AREAS 2×10^{-9} Torr.

Figure 14. RHIC gold beam life times and emittances for operating scenarios and resultant pressures.

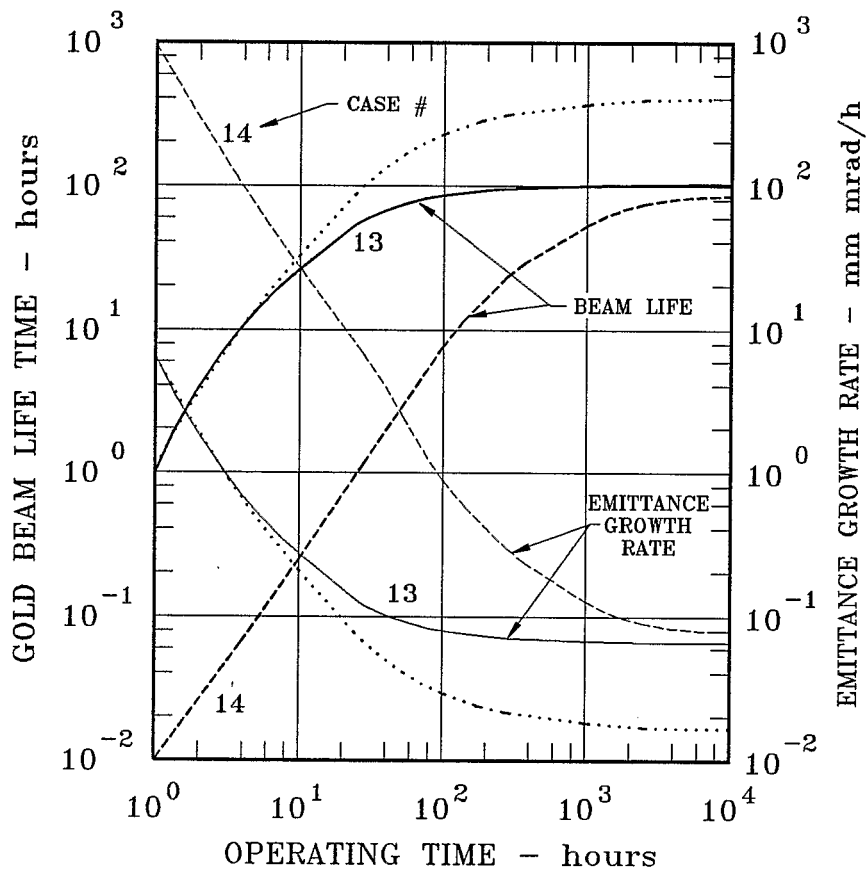

IDEAL CASE: - - - - -

FIVE EXPERIMENTAL REGIONS (ALL CASES):

CONTAMINATED EXPERIMENTAL BEAM PIPE AND DX BEAM PIPE.

4:00 O'CLOCK REGION:

CASE 13&14: SWCs OUTGASSING AS $f(t)$ FROM START.

Q3-Q4 RF SYSTEMS:

CASE 13: SWCs OUTGASSING AS $f(t)$ FROM START.

CASE 14: ACs OUTGASSING & AGED AT 1/10 TIME OF SWCs.

10:00 O'CLOCK BEAM DUMP REGION:

$P_{avg. H_2}$ EQUIV. PRESSURE @ BEAM DUMP AREAS 2×10^{-9} Torr.

"wbsum7"
 Kimo M. Welch
 June 23, 1994
 1.5,0.5; 0.75=1

Table IIa. Average pressures in experimental areas.

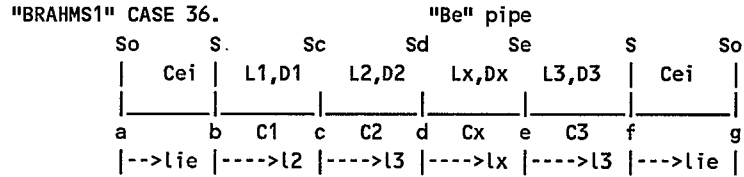

Kimo M. Welch
April 29, 1994

1. Cei is an effective tube comprising the D0 to DX chambers and the D0 chamber.
2. Cx comprises the Brahms experimental chambers w/ D1,D2,Dx,D3, & L1,L2,Lx,L3, pipes. The Dx diam. is a variable and the Lx length. However L3+Lx+L2+L1 is constant.
3. Define SWz as the pumping a locating z as a consequence of all of the pumps from z to w. including the pump located at w.

CASE 36.

1.9E-11 1.9E-12 1.9E-13 H2
1.0E-12 1.0E-13 1.0E-14 CO
AMU: 2 H2

q: 1.9E-12 Torr-L/s cm² (beam pipe).
qx: 1.9E-12 Torr-L/s cm² (experimental beam pipe).
qie: 7.6E-12 Torr-L/s cm² (DX magnet equiv. beam pipe).

So: 6441.6 L/s; cryopumping of D0s G
S: 100.0 L/s

Sc:	0.0	22	L3:	640.0 cm; a constant.
Sd:	0.0	23	Lx:	500.0 cm; plug in variable
Se:	0.0	24	L2:	300.0 cm; varies w/ Lx.
Cei:	122.2 L/s	25	L1:	326.0 cm, a constant
C1:	249.5 L/s	26	D3:	12.1 cm, a constant
C2:	162.4	27	Dx:	5.9 cm; a variable.
Cx:	18.9	28	D2:	10.2 cm; a constant.
C3:	127.1	29	D1:	12.1 cm; a constant.
Sab:	219.9	30	D1 ³ /L1:	5.4
Sac:	116.9	31	D2 ³ /L2:	3.5
Sad:	68.0	32	D3 ³ /L3:	2.8
Sae:	14.8	33	Dx ³ /Lx:	0.4
Saf:	113.2	34	Dei:	15.6
Sgf:	219.9	35	Lei:	1434.0
Sge:	80.5			
Sgd:	15.3			
Sgc:	14.0			
Sgb:	113.2			
k:	45.9			

EXPERIMENTAL	D0 to D0
AVERAGE	AVERAGE
H2	H2
PRESSURE	PRESSURE
Due to Lie: 1.24E-09	9.89E-10
Due to L3: 2.90E-10	1.10E-10
Due to L2: 1.03E-10	4.51E-11
Due to L1: 7.49E-11	4.46E-11
Due to Lx: 1.97E-10	5.49E-11
-----	-----
Total: 1.90E-09	Total: 1.24E-09

Table IIb. AVERAGE PRESSURES AT & ABOUT BRAHMS DETECTOR DUE TO OUTGASSING OF VARIOUS BEAM PIPES.

Kimo M. Welch
June 20, 1994

"brahms2"														ONE	ALL 6		
DETECTOR BEAM PIPE		DX MAGNET BEAM PIPE		L1, L2 & L3 BEAM PIPE		PUMP SPEED				"Be" PIPE		X-PIPE	D0-D0	D0-D0*	BEAM**	BEAM**	
CASE	q H2	q CO	q H2	q CO	q H2	q CO	S	Sc	Sd	Se	Dx	Lx	PRESSURE	From Pipe	From Pipe	LIFE	LIFE
No.	Torr-L/s-cm ²	Torr-L/s-cm ²	Torr-L/s-cm ²	Torr-L/s-cm ²	Torr-L/s-cm ²	Torr-L/s-cm ²		Liters/sec.			cm	cm	Tot. Torr	Tot. Torr	Equiv. H2	hours	hours
1	1.90E-11	1.00E-12	1.90E-11	1.00E-12	1.90E-11	1.00E-12	100	0	0	0	5.9	500	1.10E-08	5.58E-09	5.92E-09	469	177
2	1.90E-12	1.00E-13	1.90E-12	1.00E-13	1.90E-12	1.00E-13	100	0	0	0	5.9	500	1.10E-09	5.58E-10	5.92E-10	694	667
3	1.90E-12	1.00E-13	1.90E-13	1.00E-14	1.90E-13	1.00E-14	100	0	0	0	5.9	500	3.18E-10	1.12E-10	1.20E-10	725	883
4	1.90E-11	1.00E-12	1.90E-11	1.00E-12	1.90E-11	1.00E-12	100	0	0	0	7.6	87.5	1.01E-08	5.77E-09	6.12E-09	464	172
5	1.90E-12	1.00E-13	1.90E-12	1.00E-13	1.90E-12	1.00E-13	100	0	0	0	7.6	87.5	1.01E-09	5.77E-10	6.12E-10	693	660
6	1.90E-12	1.00E-13	1.90E-13	1.00E-14	1.90E-13	1.00E-14	100	0	0	0	7.6	87.5	1.36E-10	6.85E-11	7.27E-11	728	912
7	1.90E-11	1.00E-12	1.90E-11	1.00E-12	1.90E-11	1.00E-12	1000	0	0	0	5.9	500	5.54E-09	2.14E-09	2.30E-09	602	354
8	1.90E-12	1.00E-13	1.90E-12	1.00E-13	1.90E-12	1.00E-13	1000	0	0	0	5.9	500	5.54E-10	2.14E-10	2.30E-10	718	821
9	1.90E-12	1.00E-13	1.90E-13	1.00E-14	1.90E-13	1.00E-14	1000	0	0	0	5.9	500	2.32E-10	5.57E-11	6.03E-11	729	920
10	1.90E-11	1.00E-12	1.90E-11	1.00E-12	1.90E-11	1.00E-12	1000	0	0	0	7.6	87.5	4.82E-09	2.23E-09	2.40E-09	597	344
11	1.90E-12	1.00E-13	1.90E-12	1.00E-13	1.90E-12	1.00E-13	1000	0	0	0	7.6	87.5	4.82E-10	2.24E-10	2.40E-10	717	815
12	1.90E-12	1.00E-13	1.90E-13	1.00E-14	1.90E-13	1.00E-14	1000	0	0	0	7.6	87.5	7.59E-11	2.82E-11	3.03E-11	731	940
13	1.90E-11	1.00E-12	1.90E-11	1.00E-12	1.90E-11	1.00E-12	100	0	100	100	5.9	500	5.52E-09	3.57E-09	3.76E-09	540	252
14	1.90E-12	1.00E-13	1.90E-12	1.00E-13	1.90E-12	1.00E-13	100	0	100	100	5.9	500	5.52E-10	3.57E-10	3.76E-10	708	751
15	1.90E-12	1.00E-13	1.90E-13	1.00E-14	1.90E-13	1.00E-14	100	0	100	100	5.9	500	1.88E-10	6.88E-11	7.25E-11	728	912
16	1.90E-11	1.00E-12	1.90E-11	1.00E-12	1.90E-11	1.00E-12	100	0	100	100	7.6	87.5	4.19E-09	3.74E-09	3.94E-09	534	244
17	1.90E-12	1.00E-13	1.90E-12	1.00E-13	1.90E-12	1.00E-13	100	0	100	100	7.6	87.5	4.19E-10	3.74E-10	3.94E-10	707	743
18	1.90E-12	1.00E-13	1.90E-13	1.00E-14	1.90E-13	1.00E-14	100	0	100	100	7.6	87.5	5.53E-11	4.24E-11	4.46E-11	730	931
19	1.90E-11	1.00E-12	1.90E-11	1.00E-12	1.90E-11	1.00E-12	1000	0	1000	1000	5.9	500	1.76E-09	1.11E-09	1.19E-09	659	509
20	1.90E-12	1.00E-13	1.90E-12	1.00E-13	1.90E-12	1.00E-13	1000	0	1000	1000	5.9	500	1.75E-10	1.11E-10	1.19E-10	725	883
21	1.90E-12	1.00E-13	1.90E-13	1.00E-14	1.90E-13	1.00E-14	1000	0	1000	1000	5.9	500	1.09E-10	2.38E-11	2.55E-11	731	944

* According to L. Remsberg, Au-->CO scales x1.6 that of Au-->H2. Therefore, Total Equiv. H2 Press = H2 Press. + 1.6*CO Press.

** This neglects decay stemming from H2 in the magnet cold-bore, but assumes Pav. throughout the rest of the warm-bore is 5*10⁻¹⁰ Torr H2. If all of the warm-bore is @ 5*10⁻¹⁰ H2, beam life would be 700 h, assuming 17% of the machine is warm-bore.

Table IIc. AVERAGE PRESSURES AT & ABOUT BRAHMS DETECTOR DUE TO OUTGASSING OF VARIOUS BEAM PIPES.

Kimo M. Welch
June 20, 1994

"brahms2"

CASE No.	DETECTOR BEAM PIPE		DX MAGNET BEAM PIPE		L1, L2 & L3 BEAM PIPE		PUMP SPEED				"Be" PIPE		X-PIPE	D0-D0	D0-D0*	ONE AREA	ALL 6 AREAS
	q H2	q CO	q H2	q CO	q H2	q CO	Liters/sec.				Dx	Lx	PRESSURE	From Pipe	From Pipe	BEAM**	BEAM**
	Torr-L/s-cm ²	Torr-L/s-cm ²	Torr-L/s-cm ²	Torr-L/s-cm ²	Torr-L/s-cm ²	Torr-L/s-cm ²	S	Sc	Sd	Se	cm	cm	Tot. Torr	Tot. Torr	Equiv. H2	LIFE hours	LIFE hours
22	1.90E-11	1.00E-12	1.90E-11	1.00E-12	1.90E-11	1.00E-12	1000	0	1000	1000	7.6	87.5	8.11E-10	1.21E-09	1.29E-09	653	489
23	1.90E-12	1.00E-13	1.90E-12	1.00E-13	1.90E-12	1.00E-13	1000	0	1000	1000	7.6	87.5	8.11E-11	1.21E-10	1.29E-10	724	877
23	1.90E-12	1.00E-13	1.90E-13	1.00E-14	1.90E-13	1.00E-14	1000	0	1000	1000	7.6	87.5	1.13E-11	1.28E-11	1.37E-11	732	952
24	5.00E-11	2.50E-11	1.90E-12	1.00E-13	1.90E-12	1.00E-13	1000	0	0	0	5.9	500	1.25E-08	2.44E-09	3.30E-09	558	277
25	5.00E-11	2.50E-11	1.90E-12	1.00E-13	1.90E-12	1.00E-13	1000	0	1000	1000	5.9	500	6.27E-09	8.85E-10	1.17E-09	660	513
26	5.00E-11	2.50E-11	1.90E-12	1.00E-13	1.90E-12	1.00E-13	1000	0	0	0	7.6	87.5	2.34E-09	5.95E-10	7.50E-10	684	616
27	5.00E-11	2.50E-11	1.90E-12	1.00E-13	1.90E-12	1.00E-13	1000	0	1000	1000	7.6	87.5	2.59E-10	1.53E-10	1.69E-10	722	854
28	7.60E-12	1.75E-11	1.90E-12	1.00E-13	1.90E-12	1.00E-13	100	0	0	0	5.9	500	7.68E-09	2.08E-09	2.92E-09	574	302
29	7.60E-12	1.75E-11	1.90E-12	1.00E-13	1.90E-12	1.00E-13	100	0	100	100	5.9	500	4.25E-09	1.06E-09	1.44E-09	645	463
30	7.60E-12	1.75E-11	1.90E-12	1.00E-13	1.90E-12	1.00E-13	1000	0	0	0	5.9	500	6.50E-09	1.29E-09	1.89E-09	622	399
31	7.60E-12	1.75E-11	1.90E-12	1.00E-13	1.90E-12	1.00E-13	1000	0	1000	1000	5.9	500	3.18E-09	4.72E-10	6.74E-10	689	639
32	1.90E-12	1.00E-13	5.00E-11	2.50E-11	1.90E-12	1.00E-13	100	0	0	0	5.9	500	1.57E-08	1.31E-08	1.68E-08	282	71
33	1.90E-12	1.00E-13	5.00E-11	2.50E-11	1.90E-12	1.00E-13	100	0	100	100	5.9	500	5.21E-09	9.36E-09	1.21E-08	341	96
34	1.90E-12	1.00E-13	5.00E-11	2.50E-11	1.90E-12	1.00E-13	1000	0	0	0	5.9	500	2.96E-09	4.23E-09	5.53E-09	481	187
35	1.90E-12	1.00E-13	5.00E-11	2.50E-11	1.90E-12	1.00E-13	1000	0	1000	1000	5.9	500	3.43E-10	3.53E-09	4.70E-09	507	213
36	1.90E-12	1.00E-13	7.60E-12	1.75E-11	1.90E-12	1.00E-13	100	0	0	0	5.9	500	6.75E-09	5.66E-09	8.31E-09	410	133
37	1.90E-12	1.00E-13	7.60E-12	1.75E-11	1.90E-12	1.00E-13	100	0	100	100	5.9	500	1.88E-09	4.04E-09	5.95E-09	469	177
38	1.90E-12	1.00E-13	7.60E-12	1.75E-11	1.90E-12	1.00E-13	1000	0	0	0	5.9	500	1.34E-09	1.93E-09	2.84E-09	577	308
39	1.90E-12	1.00E-13	7.60E-12	1.75E-11	1.90E-12	1.00E-13	1000	0	1000	1000	5.9	500	2.10E-10	1.63E-09	2.45E-09	595	340

* According to L. Remsberg, Au-->CO scales x1.6 that of Au-->H2. Therefore, Total Equiv. H2 Press = H2 Press. + 1.6*CO Press.

** This neglects decay stemming from H2 in the magnet cold-bore, but assumes Pav. throughout the rest of the warm-bore is 5*10⁻¹⁰ Torr H2. If all of the warm-bore is @ 5*10⁻¹⁰ H2, beam life would be 700 h, assuming 17% of the machine is warm-bore.

Table IIIb. AVERAGE PRESSURES AT 4 O'CLOCK DUE TO OUTGASSING OF RF CAVITIES AND BAKED BEAM PIPES.

Kimo M. Welch
June 15, 1994

"4oclock"															
CASE No.	BEAM PIPE		RF CAVITY (1)		PUMP SPEED		"Be" PIPE		X-PIPE	D0-D0	D0-D0	D0-D0	D0-D0*	H2 Qo In	BEAM**
	q H2	q CO	q H2	q CO	S1	S2	D3	L3	PRESSURE	From Pipe	From RF	COMBINED	COMBINED	D0 Bore	LIFE
	Torr-L/s-cm ²		Torr-L/s		L/s		cm	Tot. Torr	Tot.Torr	Tot.Torr	Tot.Torr	Tot.Torr	Equiv.H2	Torr-L/s	hours
1	1.90E-12	1.00E-13	1.20E-05	2.74E-06	100	100	5.9	500	7.22E-09	3.77E-10	4.84E-09	5.22E-09	6.29E-09	1.22E-06	448
2	1.90E-12	1.00E-13	1.20E-05	2.74E-06	0	100	5.9	500	8.31E-09	3.79E-10	5.24E-09	5.62E-09	6.85E-09	1.22E-06	434
3	1.90E-12	1.00E-13	1.20E-05	2.74E-06	0	0	5.9	500	8.34E-09	3.84E-10	5.54E-09	5.92E-09	7.28E-09	1.33E-06	424
4	1.90E-12	1.00E-13	1.20E-05	2.74E-06	100	100	7.6	87.5	7.38E-09	2.82E-10	5.08E-09	5.36E-09	6.46E-09	1.28E-07	444
5	1.90E-12	1.00E-13	1.20E-05	2.74E-06	0	100	7.6	87.5	8.51E-09	2.85E-10	5.48E-09	5.76E-09	7.01E-09	1.22E-06	430
6	1.90E-12	1.00E-13	1.20E-05	2.74E-06	0	0	7.6	87.5	8.55E-09	2.91E-10	5.80E-09	6.09E-09	7.46E-09	1.33E-06	419
7	1.90E-12	1.00E-13	1.20E-05	2.74E-06	1000	1000	5.9	500	3.49E-09	2.59E-10	2.55E-09	2.80E-09	3.25E-09	7.11E-07	544
8	1.90E-12	1.00E-13	1.20E-05	2.74E-06	0	1000	5.9	500	7.74E-09	2.66E-10	4.03E-09	4.30E-09	5.20E-09	7.18E-07	478
9	1.90E-12	1.00E-13	1.20E-05	2.74E-06	0	0	5.9	500	7.85E-09	2.85E-10	5.36E-09	5.64E-09	6.97E-09	1.33E-06	431
9a	1.90E-12	1.00E-13	1.20E-05	2.74E-06	1000	0	5.9	500	3.54E-09	2.78E-10	3.83E-09	4.11E-09	4.96E-09	1.31E-06	485
10	1.90E-12	1.00E-13	1.20E-05	2.74E-06	1000	1000	7.6	87.5	3.25E-09	1.73E-10	2.56E-09	2.73E-09	3.17E-09	7.11E-07	547
11	1.90E-12	1.00E-13	1.20E-05	2.74E-06	0	1000	7.6	87.5	7.43E-09	1.82E-10	3.93E-09	4.11E-09	4.97E-09	7.18E-07	485
12	1.90E-12	1.00E-13	1.20E-05	2.74E-06	0	0	7.6	87.5	7.56E-09	2.07E-10	5.31E-09	5.52E-09	6.81E-09	1.33E-06	435
13	1.90E-12	1.00E-13	2.40E-06	5.48E-07	1000	1000	5.9	500	1.10E-09	2.59E-10	5.09E-10	7.68E-10	8.76E-10	3.01E-07	653
14	1.90E-12	1.00E-13	6.00E-06	1.37E-06	1000	1000	5.9	500	1.99E-09	2.59E-10	1.27E-09	1.53E-09	1.77E-09	4.55E-07	607
15	1.90E-12	1.00E-13	2.40E-05	5.48E-06	1000	1000	5.9	500	6.46E-09	2.59E-10	5.09E-09	5.35E-09	6.22E-09	1.22E-06	450
16	1.90E-12	1.00E-13	6.00E-05	1.37E-05	1000	1000	5.9	500	1.54E-08	2.59E-10	1.27E-08	1.30E-08	1.51E-08	2.76E-06	296
17	1.90E-12	1.00E-13	2.40E-06	5.48E-07	10000	10000	5.9	500	5.57E-10	2.21E-10	1.78E-10	3.98E-10	4.54E-10	5.71E-08	677
18	1.90E-12	1.00E-13	6.00E-06	1.37E-06	10000	10000	5.9	500	7.10E-10	2.21E-10	4.43E-10	6.64E-10	7.71E-10	8.70E-08	659
19	1.90E-12	1.00E-13	1.20E-05	2.74E-06	10000	10000	5.9	500	9.84E-10	2.21E-10	8.86E-10	1.11E-09	1.30E-09	1.37E-07	631
20	1.90E-12	1.00E-13	2.40E-05	5.48E-06	10000	10000	5.9	500	1.47E-09	2.21E-10	1.77E-09	2.00E-09	2.36E-09	2.37E-07	580
21	1.90E-12	1.00E-13	6.00E-05	1.37E-05	10000	10000	5.9	500	3.00E-09	2.21E-10	4.43E-09	4.65E-09	5.54E-09	5.37E-07	468

* According to L. Remsberg, Au -->CO scales x1.6 that of Au -->H2. Therefore, Total Equiv. H2 Press. = H2 Press. + 1.6*CO Press.

** This neglects decay stemming from H2 in the magnet cold-bore, but assumes Pav. throughout the rest of the warm-bore is 5*10⁻¹⁰ Torr H2.

If all of warm-bore is 5*10⁻¹⁰ Torr H2, beam life would be 700 h, assuming 17% of the machine is warm-bore.

(1) Cases 1-12 is for cavity outgassing after ~280 hours of operation.

"z4oclock"

Table IIIc. Outgassing of the Standing Wave Cavities @ 4:00 O'clock as a Function of Time.

CASE No.	CAVITY AGE-IN hours	RF CAVITY		PUMP SPEED		"Be" PIPE		X-PIPE	D0-D0	D0-D0	D0-D0	D0-D0*	H2 Qo In	BEAM**
		q H2 Torr-L/s	q CO Torr-L/s	S1 L/s	S2 L/s	D3 cm	L3 cm	PRESSURE Tot. Torr	From Pipe Tot. Torr	From RF Tot. Torr	COMBINED Tot. Torr	COMBINED Tot. Torr	Equiv. H2	D0 Bore Torr-L/s
22	1	1.17E-02	2.71E-03	1000	1000	5.9	500	2.92E-06	2.59E-10	2.49E-06	2.49E-06	2.91E-06	5.00E-04	3
23	10	3.54E-04	8.22E-05	1000	1000	5.9	500	8.88E-08	2.59E-10	7.54E-08	7.57E-08	8.83E-08	1.53E-05	78
24	28	9.59E-05	2.23E-05	1000	1000	5.9	500	2.44E-08	2.59E-10	2.04E-08	2.07E-08	2.42E-08	4.29E-06	220
25	100	2.66E-05	6.17E-06	1000	1000	5.9	500	7.14E-09	2.59E-10	5.67E-09	5.93E-09	6.91E-09	1.33E-06	432
7	280	1.20E-05	2.74E-06	1000	1000	5.9	500	3.49E-09	2.59E-10	2.55E-09	2.80E-09	3.25E-09	7.11E-07	544
26	1000	6.05E-06	1.40E-06	1000	1000	5.9	500	2.01E-09	2.59E-10	1.29E-09	1.55E-09	1.78E-09	4.57E-07	606
27	10000	3.10E-06	7.20E-07	1000	1000	5.9	500	1.28E-09	2.59E-10	6.60E-10	9.19E-10	1.05E-09	3.31E-07	643

* According to L. Remsberg, Au -->CO scales x1.6 that of Au -->H2. Therefore, Total Equiv. H2 Press. = H2 Press. + 1.6*CO Press.

** This neglects decay stemming from H2 in the magnet cold-bore, but assumes Pav. throughout the rest of the warm-bore is 5*10⁻¹⁰ Torr H2.

If all of warm-bore is 5*10⁻¹⁰ Torr H2, beam life would be 700 h, assuming 17% of the machine is warm-bore.

(1) Model assumes q(H2)~1.9*10⁻¹² Torr-L/s cm² & q(CO)~10⁻¹³ Torr-L/s cm² for beam pipes.

Kimo M. Welch
May 26, 1994

Table Va. Calculations of pressures between Q3 & Q4 due to SWCs & ACs.

"rfatq4q3"

CASE 42. H2

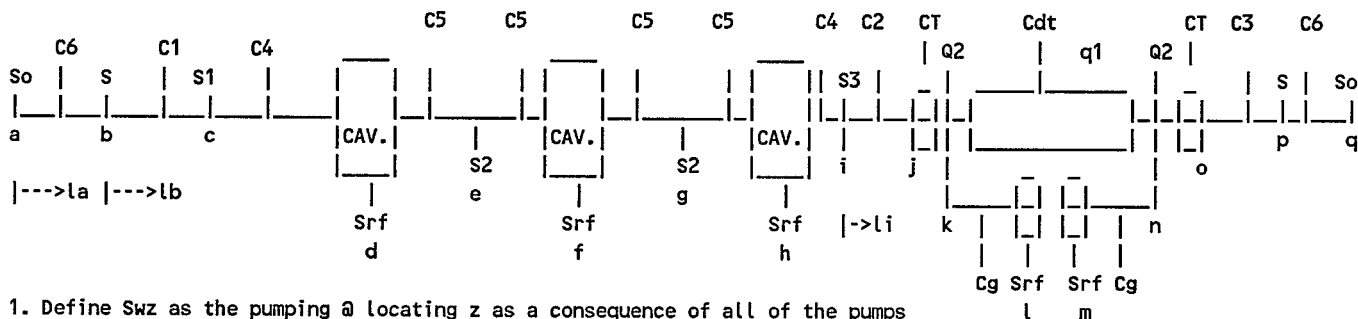

1. Define Swz as the pumping @ locating z as a consequence of all of the pumps from w to z, including the pump located at z.

1.9E-12 1.0E-13

AMU:	2	CASE 42.	H	cm
qo:	1.90E-12	Torr-L/s cm ² (beam pipe).	19 Ddt:	24.0 cm
q1:	1.90E-12	Torr-L/s cm ² (rf pipe).	20 Ldt:	429.0 cm
Srf:	1367	L/s <--- H2 or CO	21 D1:	12.3 cm
So:	6442	L/s; cryopumping of D0s	22 L1:	1630.0 cm
S:	1000		23 D2:	12.3 cm
S1:	0	L/s Srf Speed L/s	24 L2:	590.0 cm
S2:	0	L/s 1367 H2 speed	25 D3:	12.3 cm
S3:	1000	462 CO speed	26 L3:	216 cm
Sab:	1754		27 D6:	12.3 cm
Sac:	51	Torr-L/s	28 L6:	100 cm
Sad:	1417	SWC Qrf:6.05E-06 H2	29 Cdt:	1480 L/s
Sae:	834		30 CT:	645 L/s
Saf:	1958	6.05E-06 H2	31 Cg:	6705 L/s
Sag:	997	1.40E-06 CO	32 C1:	52 L/s
Sah:	2036		33 C2:	145 L/s
Sai:	2075	Q2 Tun: 3.04E-08 H2	34 C3:	396 L/s
Saj:	135	3.04E-08 H2	35 C4:	2277 L/s
Sak:	1247	1.60E-08 CO	36 C5:	2030 L/s
San:	1812		37 C6:	854
Sao:	476		38 k:	45.9
Sap:	1216		39 L4:	24.1
Sqp:	1754	AC Q4: 1.94E-05 H2	40 L5:	43.2
Sqo:	323	(x3.6*Qrf)	41 LT:	85.2
Sqn:	1400		Sigma L:	3456.4
Sqk:	1158			
Sqj:	414			
Sqi:	1107			
Sqh:	2112			
Sqg:	1035			
Sqf:	2053			
Sqe:	1021			
Sqd:	2046			
Sqc:	1078			
Sqb:	1050			

CASE 42. Kimo M. Welch
June 17, 1994

AVERAGE PRESSURES D0-D0	H2
Due to Stainless Beam Pipe:	1.29E-10
Due Acc. Cavity Drift Tubes:	5.67E-12
Due to Accelerating Cavities:	7.64E-09
Due Acc. Cavity Tunners:	6.92E-12
Due to Standing Wave Cavities:	1.48E-09

	9.26E-09 Torr
Throughput into Q3 beam pipe:	2.85E-06 Torr-L/s
Throughput into Q4 beam pipe:	1.23E-07
	H2
Pressure in Tunner Gap @ k:	1.09E-08 Torr
Pressure in Tunner Gap @ n:	7.98E-09 Torr

"f1rfq4q3"

Table Vb. Outgassing of the Standing Wave & Accelerating Cavities Located Between Q4 & Q3,
Based on CERN/Englemann Outgassing Data for the Standing Wave Cavities (1-3).
One Thousand Hours Into the Cavity Age-In Cycle.

Kimo M. Welch
June 18, 1994

CASE No.	Acc.Cav. (Q4) Torr-L/s	PUMPING SPEEDS - L/s				Q3-Q4 Tot	Q3-Q4 Tot	Q3-Q4 Tot	Q3-Q4 SS	Q3-Q4	Q3-Q4*	H2 Qo In	BEAM**	A.C.Gap k	Normalizd
		S	S1	S2	S3	Acc. Cav. Torr	SWCs Tot.Torr	DT/Tuner Tot.Torr	BEAM PIPE Tot.Torr	COMBINED Tot.Torr	COMBINED Equiv.H2	Q3 Bore Torr-L/s	LIFE hours	COMBINED Tot. Torr	Emittance Growth(4) mm mrad/h
6	x3.2*Qrf	1000	1000	1000	1000	0.00E+00	9.95E-10	2.31E-11	1.43E-10	1.16E-09	1.32E-09	2.84E-06	629.45	1.84E-08	1.06E-04
13	x1.0*Qrf	1000	1000	1000	1000	0.00E+00	9.95E-10	2.31E-11	1.43E-10	1.16E-09	1.32E-09	8.96E-07	629.45	6.01E-09	1.06E-04
20	x3.2*Qrf	1000	1000	0	1000	0.00E+00	1.33E-09	2.32E-11	1.44E-10	1.50E-09	1.74E-09	2.84E-06	608.78	1.84E-08	1.10E-04
27	x3.2*Qrf	1000	1000	0	0	0.00E+00	2.67E-09	2.38E-11	1.46E-10	2.84E-09	3.43E-09	2.84E-06	537.07	1.95E-08	1.25E-04
34	x1.0*Qrf	1000	1000	0	0	0.00E+00	2.67E-09	2.38E-11	1.46E-10	2.84E-09	3.43E-09	8.98E-07	537.07	7.03E-09	1.25E-04
40	x1.0*Qrf	100	100	0	0	0.00E+00	3.63E-09	2.48E-11	1.67E-10	3.82E-09	4.68E-09	1.76E-06	493.93	7.14E-09	1.35E-04
41	x3.2*Qrf	100	100	0	0	0.00E+00	3.63E-09	2.48E-11	1.67E-10	3.82E-09	4.68E-09	5.63E-06	493.93	1.97E-08	1.35E-04
42	x3.2*Qrf	1000	0	0	1000	0.00E+00	2.38E-09	2.32E-11	1.52E-10	2.55E-09	3.11E-09	2.84E-06	549.35	1.85E-08	1.22E-04
36	(5)	1000	0	0	1000	1.52E-09	2.38E-09	3.32E-10	1.52E-10	4.38E-09	5.91E-09	8.45E-08	458.01	4.35E-09	1.46E-04
										0.00E+00		705.44			

* According to L. Rensberg, Au -->CO scales x1.6 that of Au -->H2. Therefore, Total Equiv. H2 Press. = H2 Press. + 1.6*CO Press.

** This neglects decay stemming from H2 in the magnet cold-bore, but assumes Pav. throughout the rest of the warm-bore is 5*10^-10 Torr H2. If all of warm-bore is 5*10^-10 Torr H2, beam life would be 700 h, assuming 17% of the machine is warm-bore.

- (1) Model assumes q(H2)~1.9*10^-12 Torr-L/s cm^2 & q(CO)~10^-13 Torr-L/s cm^2 for beam pipes, and drift tubes.
- (2) Qrf is defined as the outgassing throughput of one SWC. The area of the Accelerating Cavities is ~x3.2 that of the SWCs.
- (3) It is assumed that pumps, with apertures, similar to those on the SWCs are used on the Accelerating Cavities.
- (4) For an average warm-bore pressure of 5*10^-10 Torr H2, growth is 9.56*10^-5 mm mrad/h.
- (5) Ambient outgassing from unbaked RT, nonoperating ACs; H2O, CO & CO2 assumed equiv. to CO.

"f2rfq4q3"

Table Vc. Outgassing of the Standing Wave & Accelerating Cavities Located Between Q4 & Q3,
Based on CERN/Englemann Outgassing Data for the Standing Wave Cavities (1-3).
One Thousand Hours Into the Cavity Age-In Cycle.

Kimo M. Welch
May 23, 1994

CASE No.	Acc.Cav. (Q4) Torr-L/s	PUMPING SPEEDS - L/s				Q3-Q4 Tot	Q3-Q4 Tot	Q3-Q4 Tot	Q3-Q4 SS	Q3-Q4	Q3-Q4*	H2 Qo In	BEAM**	A.C.Gap k	Normalized
		S	S1	S2	S3	Acc. Cav. Torr	SWCs Tot.Torr	DT/Tuner Tot.Torr	BEAM PIPE Tot.Torr	COMBINED Tot.Torr	COMBINED Equiv.H2	Q3 Bore Torr-L/s	LIFE hours	COMBINED Tot. Torr	Emittance Growth(4) mm mrad/h
6	x3.2*Qrf	1000	1000	1000	1000	1.32E-08	0.00E+00	2.31E-11	1.43E-10	1.34E-08	1.68E-08	2.84E-06	278.21	1.84E-08	2.41E-04
13	x1.0*Qrf	1000	1000	1000	1000	4.13E-09	0.00E+00	2.31E-11	1.43E-10	4.30E-09	5.38E-09	8.96E-07	472.93	6.01E-09	1.42E-04
20	x3.2*Qrf	1000	1000	0	1000	1.33E-08	0.00E+00	2.32E-11	1.44E-10	1.35E-08	1.69E-08	2.84E-06	277.29	1.84E-08	2.41E-04
27	x3.2*Qrf	1000	1000	0	0	1.46E-08	0.00E+00	2.38E-11	1.46E-10	1.47E-08	1.86E-08	2.84E-06	261.44	1.95E-08	2.56E-04
34	x1.0*Qrf	1000	1000	0	0	4.55E-09	0.00E+00	2.38E-11	1.46E-10	4.72E-09	5.93E-09	8.98E-07	457.35	7.03E-09	1.46E-04
40	x1.0*Qrf	100	100	0	0	4.78E-09	0.00E+00	2.48E-11	1.67E-10	4.97E-09	6.25E-09	1.76E-06	448.83	7.14E-09	1.49E-04
41	x3.2*Qrf	100	100	0	0	1.53E-08	0.00E+00	2.48E-11	1.67E-10	1.55E-08	1.96E-08	5.63E-06	253.00	1.97E-08	2.65E-04
42	x3.2*Qrf	1000	0	0	1000	1.33E-08	0.00E+00	2.32E-11	1.52E-10	1.35E-08	1.69E-08	2.84E-06	276.73	1.84E-08	2.42E-04
										0.00E+00		705.44			

* According to L. Remsberg, Au -->CO scales x1.6 that of Au -->H2. Therefore, Total Equiv. H2 Press. = H2 Press. + 1.6*CO Press.

** This neglects decay stemming from H2 in the magnet cold-bore, but assumes Pav. throughout the rest of the warm-bore is 5*10^-10 Torr H2. If all of warm-bore is 5*10^-10 Torr H2, beam life would be 700 h, assuming 17% of the machine is warm-bore.

- (1) Model assumes q(H2)~1.9*10^-12 Torr-L/s cm^2 & q(CO)~10^-13 Torr-L/s cm^2 for beam pipes, and drift tubes.
- (2) Qrf is defined as the outgassing throughput of one SWC. The area of the Accelerating Cavities is ~x3.2 that of the SWCs.
- (3) It is assumed that pumps, with apertures, similar to those on the SWCs are used on the Accelerating Cavities.
- (4) For an average warm-bore pressure of 5*10^-10 Torr H2, growth is 9.56*10^-5 mm mrad/h.

"hrfq4q3"

Table Vd. Outgassing of the Standing Wave & Accelerating Cavities Located Between Q4 & Q3,
Based on CERN/Englemann Outgassing Data for the Standing Wave Cavities (1-3).

Kimo M. Welch
June 15, 1994

CASE No.	CAVITY AGE-IN hours	PUMPING SPEEDS - L/s				Q3-Q4 Tot	Q3-Q4 Tot	Q3-Q4 Tot	Q3-Q4 SS	Q3-Q4	Q3-Q4*	H2 Qo In	BEAM**	A.C.Gap k	Normalized Emittance Growth(4)
		S	S1	S2	S3	Acc. Cav. Torr	SWCs Tot.Torr	DT/Tuner Tot.Torr	BEAM PIPE Tot.Torr	COMBINED Tot.Torr	COMBINED Equiv.H2	Q3 Bore Torr-L/s	LIFE hours	COMBINED Tot. Torr	mm mrad/h
15	1	1000	1000	0	1000	0.00E+00	2.58E-06	2.31E-11	1.44E-10	2.58E-06	3.00E-06	5.47E-03	2.56	3.53E-05	2.61E-02
16	10	1000	1000	0	1000	0.00E+00	7.81E-08	2.31E-11	1.44E-10	7.83E-08	9.10E-08	1.65E-04	75.70	1.07E-06	8.84E-04
17	28	1000	1000	0	1000	0.00E+00	2.12E-08	2.31E-11	1.44E-10	2.13E-08	2.48E-08	4.48E-05	216.00	2.89E-07	3.10E-04
18	100	1000	1000	0	1000	0.00E+00	5.87E-09	2.31E-11	1.44E-10	6.04E-09	7.01E-09	1.24E-05	429.93	8.05E-08	1.56E-04
19	280	1000	1000	0	1000	0.00E+00	2.64E-09	2.31E-11	1.44E-10	2.80E-09	3.25E-09	5.62E-06	543.96	3.61E-08	1.23E-04
20	1000	1000	1000	0	1000	0.00E+00	1.33E-09	2.31E-11	1.44E-10	1.50E-09	1.74E-09	2.84E-06	608.79	1.84E-08	1.10E-04
21	10000	1000	1000	0	1000	0.00E+00	6.85E-10	2.31E-11	1.44E-10	8.52E-10	9.83E-10	1.46E-06	647.29	9.59E-09	1.03E-04
											0.00E+00		705.44		

- * According to L. Remsberg, Au -->CO scales x1.6 that of Au -->H2. Therefore, Total Equiv. H2 Press. = H2 Press. + 1.6*CO Press.
- ** This neglects decay stemming from H2 in the magnet cold-bore, but assumes Pav. throughout the rest of the warm-bore is $5 \cdot 10^{-10}$ Torr H2. If all of warm-bore is $5 \cdot 10^{-10}$ Torr H2, beam life would be 700 h, assuming 17% of the machine is warm-bore.
- (1) Model assumes $q(H2) \sim 1.9 \cdot 10^{-12}$ Torr-L/s cm^2 & $q(CO) \sim 10^{-13}$ Torr-L/s cm^2 for beam pipes, and drift tubes.
 - (2) Qrf is defined as the outgassing throughput of one SWC. It is assumed that outgassing ACs is $\sim x3.2$ that of the SWCs.
 - (3) It is assumed that pumps, with apertures, similar to those on the SWCs are used on the Accelerating Cavities.
 - (4) For an average warm-bore pressure of $5 \cdot 10^{-10}$ Torr H2, growth is $9.56 \cdot 10^{-5}$ mm mrad/h.

"hrfq4q3"

Table Ve. Outgassing of the Standing Wave & Accelerating Cavities Located Between Q4 & Q3,
Based on CERN/Englemann Outgassing Data for the Standing Wave Cavities (1-3).

Kimo M. Welch
June 15, 1994

CASE No.	CAVITY AGE-IN hours	PUMPING SPEEDS - L/s				Q3-Q4 Tot	Q3-Q4 Tot	Q3-Q4 Tot	Q3-Q4 SS	Q3-Q4	Q3-Q4*	H2 Qo In	BEAM**	A.C.Gap k	Normalized
		S	S1	S2	S3	Acc. Cav. Torr	SWCs Tot.Torr	DT/Tuner Tot.Torr	BEAM PIPE Tot.Torr	COMBINED Tot.Torr	COMBINED Equiv.H2	Q3 Bore Torr-L/s	LIFE hours	COMBINED Tot. Torr	Emittance Growth(4) mm mrad/h
15	1	1000	1000	0	1000	2.57E-05	0.00E+00	2.31E-11	1.44E-10	2.57E-05	3.23E-05	5.47E-03	0.24	3.53E-05	2.80E-01
16	10	1000	1000	0	1000	7.79E-07	0.00E+00	2.31E-11	1.44E-10	7.79E-07	9.80E-07	1.65E-04	7.79	1.07E-06	8.59E-03
17	28	1000	1000	0	1000	2.11E-07	0.00E+00	2.31E-11	1.44E-10	2.11E-07	2.65E-07	4.48E-05	27.95	2.89E-07	2.39E-03
18	100	1000	1000	0	1000	5.85E-08	0.00E+00	2.31E-11	1.44E-10	5.87E-08	7.37E-08	1.24E-05	91.12	8.05E-08	7.34E-04
19	280	1000	1000	0	1000	2.62E-08	0.00E+00	2.31E-11	1.44E-10	2.64E-08	3.30E-08	5.62E-06	175.44	3.61E-08	3.81E-04
20	1000	1000	1000	0	1000	1.33E-08	0.00E+00	2.31E-11	1.44E-10	1.35E-08	1.69E-08	2.84E-06	277.29	1.84E-08	2.41E-04
21	10000	1000	1000	0	1000	6.82E-09	0.00E+00	2.31E-11	1.44E-10	6.99E-09	8.76E-09	1.46E-06	391.65	9.59E-09	1.71E-04
											0.00E+00		705.44		9.49E-05

* According to L. Remsberg, Au -->CO scales x1.6 that of Au -->H2. Therefore, Total Equiv. H2 Press. = H2 Press. + 1.6*CO Press.

** This neglects decay stemming from H2 in the magnet cold-bore, but assumes Pav. throughout the rest of the warm-bore is 5*10^-10 Torr H2. If all of warm-bore is 5*10^-10 Torr H2, beam life would be 700 h, assuming 17% of the machine is warm-bore.

- (1) Model assumes q(H2)~1.9*10^-12 Torr-L/s cm^2 & q(CO)~10^-13 Torr-L/s cm^2 for beam pipes, and drift tubes.
- (2) Qrf is defined as the outgassing throughput of one SWC. It is assumed that outgassing ACs is ~x3.2 that of the SWCs.
- (3) It is assumed that pumps, with apertures, similar to those on the SWCs are used on the Accelerating Cavities.
- (4) For an average warm-bore pressure of 5*10^-10 Torr H2, growth is 9.56*10^-5 mm mrad/h.

Table VI. Examples of some of the warm-bore scenarios investigated.

	SUMMARY CASE NUMERS														
EXPERIMENTAL REGIONS (D0-D0,5):	1	2	3	4	5	6	7	8	9	10	11	12	13	14	15
1 Ideal case: (i.e., $\sim 3 \cdot 10^{-10}$ Torr equiv. H2).	X	X	X												
2 Half-baked EBPs.				X	X	X				X	X	X			
3 Half-baked DX magnets.							X	X	X	X	X	X			
4 Contaminated experimental beam pipe.													X	X	X
4:00 O'CLOCK REGION (1):															
1 SWCs as f(t) from start.	X	X		X	X		X	X		X	X		X	X	
2 SWCs @ 10,000 h.			X			X			X			X			X
Q3-Q4 RF SYSTEMS:															
1 SWCs as f(t) from start; non-operating ACs.	X		X	X		X	X		X	X		X	X	X	X
2 Instantaneous life and emittance w/ ACs aged at 1/10 the time of SWCs.		X			X			X			X			X	
3															
BEAM DUMP (10:00 O'clock):															
1 Assume average pressure $2 \cdot 10^{-9}$ Torr H2 equiv.	X	X	X	X	X	X	X	X	X	X	X	X	X	X	X
EMITTANCE & BEAM LIFE TIME FIGURE NUMBER:	10	10	10	11	11		12	12		13	13		14	14	

Kimo M. Welch
 June 21, 1994
 "warmbor2"