

Preface (added April 2003)

Note: *The KFM, A Homemade Yet Accurate and Dependable Fallout Meter*, was published by Oak Ridge National Laboratory report in 1979. Some of the materials originally suggested for suspending the leaves of the Kearny Fallout Meter (KFM) are no longer available. Because of changes in the manufacturing process, other materials (e.g., sewing thread, unwaxed dental floss) may not have the insulating capability to work properly. Oak Ridge National Laboratory **has not tested** any of the following suggestions, but they have been used by other groups. When using these instructions, the builder can verify the insulating ability of his materials by checking the leakage rate and comparing it to the author's leakage tests.

- The principal author, Cresson Kearny, updated his instructions after his retirement from ORNL in Appendix C of an 1987 edition of *Nuclear War Survival Skills*¹ to include two suggestions for thin monofilament fishing line and narrow strips of dry cleaning bags:

“Very thin monofilament fishing line or leader is an excellent insulator. The 2-pound- test strength, such as DuPont's ‘Stren’ monofilament fishing line, is best. ‘Trilene’ 2-pound “nylon leader” a monofilament manufactured by Berkley and Company, also is excellent. (A 4-pound monofilament line will serve, but is disadvantageously stiff.) Some modern monofilament lines or leaders such as ‘Trilene’ contain an additive that makes them pliant, but also makes them poorer insulators for the first several hours after being taken out of their dispenser and used to suspend the leaves of a KFM. However, in about 6 hours the silica gel or anhydrite drying agent in a KFM removes this additive and the monofilament becomes as good an insulator as an even strands of unwaxed dental floss” [tested dental floss no longer available].

“To minimize the chance of using a piece of monofilament or other thread that has been soiled and thus changed into a poor insulator, always first remove and discard the outermost layer of thread on any spool that has not been kept clean in a plastic bag or other packaging after being initially unwrapped.

“...most American homes have an excellent insulator, very thin polyethylene film—especially clean dry cleaners' bags. A narrow insulating strip cut only 1/16 inch wide can be used to suspend each KFM leaf, instead of an insulating thread. (Installed leaves suspended on strips of thin plastic film must be handled with care.)

“To cut 1/16-inch-wide strips from very thin polyethylene film, first cut a piece about 6 x 10 inches. Tape only the two 6-inch-wide ends to a piece of paper (such as a brown grocery bag), so that the film is held flat and smooth on the paper. Make 10 marks. 1/16 inch apart, on each of the two tapes that are holding the film. Place a light so that its reflection on the film enables you to see the edge of the film that you are preparing to

¹URL: <http://www.oism.org/nwss/> (accessed Mar. 4, 2003).

cut. Then use a very sharp, clean knife or clean razor blade, guided by the edge of a firmly held ruler, to cut nine strips, of which you will select the best two. When cutting, hold the knife almost horizontal, with the plane of its blade perpendicular to the taped-down film. Throughout this procedure avoid touching the center parts of the strips.”²

- A Utah teacher, who uses the Kearny Fallout Meter, in teaching about radiation, has found that strands of clean human hair (cleaned with shampoo or alcohol) can be used as an alternative suspension system³.

²New material only: Copyright (c) 1986 by Cresson H. Kearny. “The copyrighted material may be reproduced without obtaining permission from anyone, provided: (1) all copyrighted material is reproduced full-scale (except for microfiche reproductions), and (2) the part of this copyright notice within quotation marks is printed along with the copyrighted material.”

³Dr. Paul Lombardi, URL: <http://www.sdavjr.davis.k12.ut.us/~paul/radiatio.htm> (accessed Mar. 4, 2003.)

DATE ISSUED

¹⁷
FEB 18 1978

ORNL-5040
(CORRECTED)

750402

**The KFM, A Homemade Yet Accurate and
Dependable Fallout Meter**

15

Cresson H. Kearny 15
Paul R. Barnes 15
Conrad V. Chester 15
Margaret W. Cortner 15

OAK RIDGE NATIONAL LABORATORY

OPERATED BY UNION CARBIDE CORPORATION FOR THE ENERGY RESEARCH AND DEVELOPMENT ADMINISTRATION

Printed in the United States of America. Available from
National Technical Information Service
U.S. Department of Commerce
5285 Port Royal Road, Springfield, Virginia 22161
Price: Printed Copy \$8.00; Microfiche \$3.00

This report was prepared as an account of work sponsored by an agency of the United States Government. Neither the United States Government nor any agency thereof, nor any of their employees, contractors, subcontractors, or their employees, makes any warranty, express or implied, nor assumes any legal liability or responsibility for any third party's use or the results of such use of any information, apparatus, product or process disclosed in this report, nor represents that its use by such third party would not infringe privately owned rights.

ORNL-5040
(CORRECTED)
Dist. Category UC-41

Contract No. W-7405-eng-26

ENERGY DIVISION

THE KFM, A. HOMEMADE YET ACCURATE AND
DEPENDABLE FALLOUT METER

Cresson H. Kearny
Paul R. Barnes
Conrad V. Chester
Margaret W. Cortner

Research sponsored by the Division of Biomedical
and Environmental Research, Department of Energy,
under contract with the Union Carbide Corporation.

Date Published: January 1978

OAK RIDGE NATIONAL LABORATORY
Oak Ridge, Tennessee 37830
operated by
UNION CARBIDE CORPORATION
for the
DEPARTMENT OF ENERGY



CONTENTS

	<u>Page</u>
LIST OF FIGURES	v
OAK RIDGE NATIONAL LABORATORY DRAWINGS AND PHOTOGRAPHS USED IN THE INSTRUCTIONS	vii
ACKNOWLEDGMENTS	ix
ABSTRACT	1
1. THE NEED FOR TRUSTWORTHY FALLOUT METERS THAT UNTRAINED AMERICANS CAN QUICKLY MAKE AND USE	1
2. OBJECTIVES OF THIS REPORT	4
3. PRIOR HOMEMADE FALLOUT INSTRUMENTS	5
4. BACKGROUND AND BASIC CAPABILITIES OF THE KEARNY FALLOUT METER (K F M)	6
5. FIELD-TESTED BUILDING AND OPERATING INSTRUCTIONS	7
5.1 Steps in the Development of the KFM Instructions	7
5.2 Objectives of These Instructions	10
5.3 Uses of This Report as Regards Its KFM Instructions	11
 <u>HOW TO MAKE AND USE A HOMEMADE FALLOUT METER, THE KFM</u>	
INSTRUCTIONS FOR PERSONS CONCERNED WITH REPRODUCING THE KFM INSTRUCTIONS	(A)
LAYOUT FOR 12-PAGE TABLOID	(B)
LOGO FORTABLOID	Page 1
I. THE NEED FOR ACCURATE AND DEPENDABLE FALLOUT METERS	Page 2
II. SURVIVAL WORK PRIORITIES DURING A CRISIS	Page 2
III. HOW TO USE THESE INSTRUCTIONS TO BEST ADVANTAGE	Page 2
IV. WHAT A KFM IS AND HOW IT WORKS	Page 3
V. MATERIALS NEEDED	Page 6
VI. USEFUL BUT NOT ESSENTIAL MATERIALS	Page 7
VII. TOOLS NEEDED	Page 7
VIII. MAKE THE DRYING AGENT	Page 7
IX. MAKE THE IONIZATION CHAMBER OF THE KFM	Page 8
X. MAKE TWO SEPARATE 8-PLY LEAVES OF STANDARD (NOT HEAVY DUTY) ALUMINUMFOIL	Page 10
XI. INSTALL THE ALUMINUM-FOIL LEAVES	Page 14

	<u>Page</u>
XII. MAKE THE PLASTIC COVER	Page 14
XIII. TWO WAYS TO CHARGE A KFM.	Page 17
XIV. MAKE AND USE A DRY-BUCKET	Page 19
xv. HOW TO USE A KFM AFTER A NUCLEAR ATTACK	Page 20
A. Background Information	Page 20
B. Finding the Dose Rate	Page 21
C. Calculating the <u>Dose Received</u>	Page 22
D. Estimating the <u>Dangers</u> from Different Doses	Page 22
E. Using a KFM to Reduce the Doses Received Inside a Shelter*	Page 23

FOUR EXTRA PATTERN PAGES (for the recipient of this report to use in making KFMs, so as not to damage the camera-ready instructions)(unnumbered)

6. ACCURACY AND RANGE OF THE KFM	13
7. CONCLUSIONS AND RECOMMENDATIONS	16

APPENDICES

A. DESIGN PRINCIPLES AND PROCEDURES USED IN DEVELOPING THE KFM.	17
B. ADDITIONAL TECHNICAL INFORMATION	23
B.1 KFM Ionization Chambers	23
B.2 Range and Accuracy of Measurements	24
B.3 Aluminum-Foil Leaves	26
B.4 Insulating Threads	29
B.5 Drying Agent	30
B.6 Three Expedient Charging Devices	32
B.7 Charging a KFM in a Dangerously High Gamma Field	35
B.8 Other Means for Charging KFMs and Similar Electroscope-Capacitors	36

LIST OF FIGURES

	<u>Page</u>
5.1 Winning Hands	8
5.2 Trimming Skirt of KFM Cover	8
6.1 Balanced Forces Operating on the Charged Leaves of a KFM	13
6.2 Calibration Curves for Two KFMs with 8-Ply Leaves	14
6.3 Normalized Calibration Points for Two KFMs, Derived Graphically from Fig. 6.2	15

APPENDIX

B.1 Calibration Curves for Three KFMs	24
B.2 Data from Fig. B.1, Normalized and Graphed	25
B.3 Data Derived from Normalized Calibration Curves	25
B.4 Aluminum-Foil Charger	34
B.5 Transferring Charge of an Aluminum-Foil Charger	34



OAK RIDGE NATIONAL LABORATORY
DRAWINGS AND PHOTOGRAPHS USED IN THE INSTRUCTIONS

	<u>Page</u>
ORNL-DWG 76-6532	page 3
ORNL-DWG 76-6533	Page 3
ORNL-DWG 76-8739	Page 3
ORNL-PHOTO 6396-76	Page 4
ORNL-PHOTO 6395-76	Page 4
ORNL-PHOTO 0186-77	Page 4
ORNL-PHOTO 6393-76	page 4
ORNL-DWG 75-11588R	Page 5
ORNL-DWG 76-6534	Page 8
ORNL-DWG 76-6537	Page 8
ORNL-DWG 76-6535	Page 9
ORNL-DWG 76-6538	Page 10
ORNL-DWG 76-6539	Page 10
ORNL-DWG 76-6540	Page 10
ORNL-DWG 76-6536	Page 11
ORNL-DWG 76-6542 ,	Page 12
ORNL-DWG 76-6541 , ,	Page 13
ORNL-DWG 76-6543	Page 14
ORNL-DWG 77-10078	Page 15
ORNL-DWG 76-6544R	Page 16
ORNL-DWG 76-6545	Page 17
ORNL-PHOTO 6390-76	Page 17
ORNL-DWG 76-6546	Page 18
ORNL-DWG 76-6547	page 18
ORNL-PHOTO 1761-76	Page 19
ORNL-DWG 76-8675	Page 19
ORNL-DWG 76-8739	Page 21



ACKNOWLEDGMENTS

The authors are indebted to Carsten M. Haaland for his recommendation to use a quickly unwound roll of tape as a high-voltage charging device and to Marjorie E. Fish for suggesting and developing the use of patterns to replace instructions for measuring and positioning parts of the KFM. We also appreciate the advice received from J. E. Jones and R. D. Smyser of The Oak Ridger and from H. J. Crouse and W. P. Allen of The Montrose Daily Press regarding the development of camera-ready copy of the instructions for making and using a KFM.

The writing of this report was improved by George A. Cristy's numerous constructive criticisms and recommendations, Ruby N. Thurmer's editorial assistance, and Walter S. Snyder's and D. B. Nelson's reviews and recommendations.



THE KFM, A HOMEMADE YET ACCURATE AND
DEPENDABLE FALLOUT METER

Cresson H. Kearny
Paul R. Barnes
Conrad V. Chester *
Margaret W. Cortner

ABSTRACT

The KFM is a homemade fallout meter that can be made using only materials, tools, and skills found in millions of American homes. It is an accurate and dependable electroscopes-capacitor. The KFM, in conjunction with its attached table and a watch, is designed for use as a rate meter. Its attached table relates observed differences in the separations of its two leaves (before and after exposures at the listed time intervals) to the dose rates during exposures of these time intervals. In this manner dose rates from 30mR/hr up to 43R/hr can be determined with an accuracy of $\pm 25\%$.

A KFM can be charged with any one of the three expedient electrostatic charging devices described. Due to the use of anhydrite (made by heating gypsum from wall-board) inside a KFM and the expedient "dry-bucket" in which it can be charged when the air is very humid, this instrument always can be charged and used to obtain accurate measurements of gamma radiation no matter how high the relative humidity.

The heart of this report is the step-by-step illustrated instructions for making and using a KFM. These instructions have been improved after each successive field test. The majority of the untrained test families, adequately motivated by cash bonuses offered for success and guided only by these written instructions, have succeeded in making and using a KFM.

-
1. THE NEED FOR TRUSTWORTHY FALLOUT METERS THAT UNTRAINED AMERICANS CAN QUICKLY MAKE AND USE

If the United States were to suffer a nuclear attack, most Americans -- especially those outside the cities and therefore most likely to survive -- would lack instruments to inform them concerning the changing dose rates

* Graduate student, Vanderbilt University, Nashville, Tennessee.

from fallout in their immediate vicinity. At present most of hundreds of thousands of civil defense rate meters and dosimeters are kept in cities in storage or in shelters unlikely to survive an all-out attack. Only a very small fraction of one percent of citizens possess fallout meters, or could obtain meters from private sources during an escalating crisis. The number of conventional fallout meters at present for sale, plus those that could be issued from government facilities during a crisis, plus those that could be produced by factories during an escalating crisis -- all of these together would be entirely inadequate to meet the needs of the tens of millions of individuals who would seek protection from fallout in many millions of separate buildings and expedient shelters.

Nor would radio reports of fallout intensities be of much use to a large fraction of the tens of millions who would survive the blast and fire effects. Many stations would be off the air as a result of blast, fire, and/or fallout effects on station personnel. Other stations would be unable to broadcast because of electromagnetic pulse (EMP) effects having destroyed essential components. In many cases station personnel may go home to their families if the sense of urgency were not communicated by the authorities or if good fallout protection were not available at the station. Furthermore, the fallout dose rates reported from the thousands of radio stations that probably would still be operating after an attack usually would be very different from the fallout dose rates around shelters occupied by survivors listening to the broadcasts.

The Subcommittee on Fallout, Advisory Committee on Civil Defense, National Academy of Sciences, has emphasized the importance of fallout meters in statements including the following:^{*} "Visible and tactile indices of fallout would provide valuable warning of danger but any real control of radiation exposure must depend on instruments."

In the event of a massive nuclear attack, millions of Americans would, under present circumstances, be killed by fallout radiation

^{*}Response to DCPA Questions on Fallout, DCPA Research Report No. 20, p. 21, November 1973, prepared by Subcommittee on Fallout, Advisory Committee on Civil Defense, National Academy of Sciences.

because of inadequate shelter. Additional millions would be killed or seriously injured because of a lack of instruments to determine the changing fallout dangers around most shelters. These additional radiation casualties would be caused primarily by the tendency of millions to leave safe but uncomfortable shelters prematurely and by the failure of many to improve their shelters if the fallout exceeded their expectations -- because they would not be able to see, feel, smell, or otherwise learn the magnitudes of the fallout dangers. Furthermore, if the occupants of shelters do not have fallout meters, some of them, not knowing how large a radiation dose they had received while inside shelter or how dangerous the fallout was outside in their immediate vicinity, may refuse to emerge -- even though they are told by local AM radio broadcasts that the radiation fields have decayed to safe levels. The failure of such prudent citizens to leave their shelters and begin recovery work -- especially the failure of isolated farmers to start cooperating in trucking grain to starving millions -- could result in serious losses.

Therefore, for essentially unprepared Americans, there is a need for a homemade fallout meter having the characteristics of the KFM (Kearny Fallout Meter), listed below.

1. Can be made using only materials and tools found in millions of American homes.
2. Can be made in a few hours and effectively operated by a large fraction of **average, untrained** American families -- even if they are guided only by **step-by-step, illustrated, written** instructions -- provided they have adequate incentives.
3. Enables gamma dose rates of 0.03 R/hr up to 43 R/hr to be measured with adequate accuracy ($\pm 25\%$ or better when made as specified), even by untrained persons guided only by the written instructions.
4. Has no requirement for the use of a radiation source, either to make, or to calibrate, or to operate the instrument. (The geometry and dimensions of a KFM and the weight of its leaves, as specified in the instructions, permanently establish its calibration.)

5. Enables the operator to determine easily whether his fallout meter is functioning properly, by merely checking to see that it can be fully charged and that its parts are not bent or out of their specified relationships.
6. Can be charged and operated reliably and accurately under the humid conditions typical of occupied fall-out shelters, and after being carried and exposed without special care.
7. Has a multiyear shelf life and requires no batteries or other components subject to harmful deterioration if stored unused for years.

2. OBJECTIVES OF THIS REPORT

This report on the KFM is being distributed while this instrument and the instructions to enable untrained Americans to make and use it are still being improved. The purpose of this early public disclosure is to solicit the help of others interested in improving survival and deterrence capabilities, and at the same time to eliminate the possibility of anyone improperly establishing patent or design rights to fallout meters of the types described herein. This disclosure will assure the rights of anyone to make and use such instruments without restrictions. Since this report is written primarily for average Americans in 1977, English units of measure are used throughout.

All persons giving recommendations for improvements in KFM design or instructions, that ORNL tests prove advantageous, will be credited in a planned ORNL report. Recommendations should be mailed to:

Solar and Special Studies Section
Energy Division
Building 4500-S, Room S-240
Oak Ridge National Laboratory
Oak Ridge, Tennessee 37830

The description of a KFM given in this paper is primarily based on the field-tested, step-by-step illustrated instructions given in Section 5.

3. PRIOR HOMEMADE FALLOUT INSTRUMENTS

To the best of the authors' knowledge and that of their associates at Oak Ridge National Laboratory, no prior homemade fallout meter satisfies more than three of the seven characteristics stated in Section 1. Attempts by others to build a simplified fallout meter using electrical components widely available in American towns were unpromising. Earlier efforts to invent a simple electrostatic fallout meter^{*} had shown that quantitative measurements of gamma radiation are possible with a homemade electrostatic instrument, although the most promising designs encountered unsolved problems.

The most useful of prior homemade fallout monitoring instruments that can be made using only materials and tools found in millions of American homes is the Alvarez Fallout Meter.^{**} This is an electroscope with two single-ply aluminum-foil leaves each suspended on parallel nylon threads that are excellent insulators. The aluminum-foil leaves are charged while outside the ionization chamber, which is a 12-oz tableware glass, lined with aluminum foil. The leaves are charged electrostatically. However, if the air is as humid as it typically is in occupied fallout shelters, the Alvarez Fallout Meter cannot be charged. Furthermore, it is not designed to give accurate readings, and

* See "The Gamma Gauge, A Quantitative, Inexpensive Electrostatic Fallout-Monitoring Device," C. H. Kearny, Annual Progress Report, Civil Defense Research Project, March 1969 - March 1970, ORNL-4566, Part I.

Also see The Electroscope - A Home-Made Radiation Detection Instrument for Home Use, by E. D. Callahan et al., Technical Operations Incorporated, Burlington, Massachusetts, May 15, 1960. This single-leaf instrument is completely discharged by a dose of only 5 mR (vs over 200 mR for the KFM). As a result, even with an impractically short 3-sec exposure time, the maximum measurable dose rate was claimed to be only 6 R/hr. Furthermore, this fallout meter cannot be charged under humid conditions and is both more difficult to build and less accurate than a KFM.

** Described in an article in "Parade," the Sunday newspaper supplement, shortly after the Cuban Missile Crisis.

the information it provides, even under those conditions when it can be charged and manipulated successfully, is only approximate and is unreliable in all but dry air, as in Los Alamos.

4. BACKGROUND AND BASIC CAPABILITIES OF THE KEARNY FALLOUT METER (KFM)

Since no satisfactory design for a homemade fallout meter was available for inclusion as an essential part of a forthcoming Oak Ridge National Laboratory (ORNL) report, Nuclear War Survival Skills (a handbook for unprepared Americans), in 1975 experimentation was initiated by the Emergency Technology Section, Health Physics Division, ORNL, directed toward inventing such an instrument.

Efforts were concentrated on designing and testing many versions of homemade electroscope-capacitors capable of being charged by simple electrostatic devices. We thought this line of experimentation the most promising because electroscopes are basic instruments for measuring ionizing radiation and because some types of electrostatic charging devices, in all but extremely humid air, are reliable, simple means of producing high-voltage charges.

The KFM model described in detail in this memorandum is the best of the thirty-odd different designs (some of which were made in several models) of simple electroscope-capacitor fallout meters made and tested by Emergency Technology Section personnel. Judging from numerous calibration tests in known gamma fields produced by radium or cobalt sources, the practical range of dose rates measurable with the best tested-to-date KFM (described in Section 5) is between 0.03 R/hr and 43 R/hr, with an accuracy of about $\pm 25\%$.

Initial laboratory and field tests indicated that a KFM satisfies all of the seven characteristics listed in Section 1 for a satisfactory homemade fallout meter.

5. FIELD-TESTED BUILDING AND OPERATING INSTRUCTIONS

At the end of this section are the field-tested instructions, "How to Make and Use a Homemade Fallout Meter, the **KFM**." These instructions are the heart of this report. They will serve the reader as a detailed description of the KFM and its operation.

No doubt these step-by-step illustrated instructions will impress most persons who have a technical background as being unnecessarily detailed and lengthy. Most Americans, however, are contented consumers, not makers of new, different devices. The KFM instructions were developed to enable as large a fraction as possible of the nongadeteering majority to build and use an instrument of a type unknown to them. Furthermore, these instructions must enable average Americans to measure radiation dangers concerning which most citizens today have more untrue than useful information.

5.1 Steps in the Development of the **KFM** Instructions

a. At different times, seven high school students who had taken at least one science course were taught by demonstrations how to build and use a KFM. Most of these students required far more detailed explanations than initially appeared necessary. The length of the instructions needed by these students was reduced by replacing with paper patterns many of the instructions for measuring and installing the parts.

b. Then several different versions of written instructions and patterns for making and charging a KFM were tested by less well-qualified builders. Especially the instructions for making and installing the aluminum-foil leaves became much more detailed, as did those for selecting alternate materials.

c. Next, four families built and charged **KFMs** while guided only by successively improved drafts of the written instructions. Crisis conditions were simulated in which the builders were permitted to receive advice from no persons outside their families. They could use only tools and materials found in their homes or obtainable from **neighbors'** homes.

To persuade average families to make KFMs under complacent peacetime conditions, money provided the essential motivation: \$25 for a 4-hour effort by three or more family members, plus a \$25 bonus if the family succeeded in making, charging, and reading a KFM successfully within the 4-hour period. (To adequately motivate an average prosperous American family during complacent times to make as good an effort as these families did, we believe considerably more money would have to be offered.)

Each of the first three test families succeeded in winning its \$25 bonus. Two of these families had no member with more than a high school academic education. One family, however, was headed by a mechanic, who read and reread the instructions, guiding his 14- and 15-year-old sons, who did essentially all the work. Another successful family was headed by a 22-year-old miner who had just lost his job. After assembling the materials, this man worked while sitting at the kitchen table for over 3 hours without once getting up or even pausing to have a drink of water. Throughout the 4 hours, his 18-year-old wife and her mother also continued to be highly motivated, in spite of losing time making and correcting several mistakes.

A family that "had never made anything" was the fourth family selected to follow the KFM written instructions. The father of this family was a university professor, the

ORNL-PHOTO 76-1771

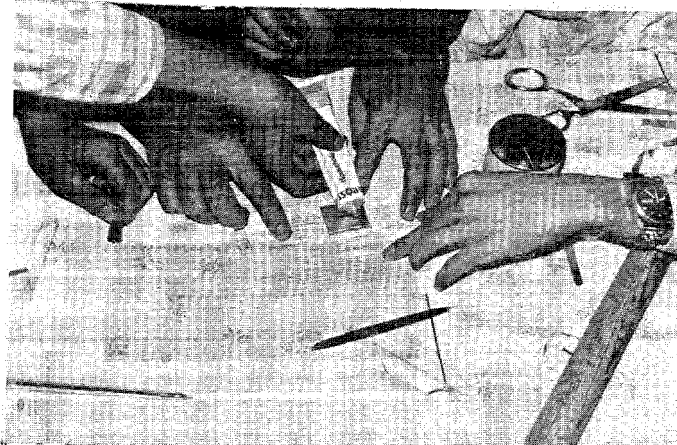

Fig. 5.1. Winning Hands. A father's fingers hold an aluminum-foil leaf on the pattern and position the suspending thread while a young son applies a very little model airplane cement.

ORNL-PHOTO 76-1772



Fig. 5.2. Concentrating on Trimming the Skirt of the Plastic Cover of a KFM.

mother was a university graduate, and the three teenage children were intelligent. Yet they failed, mostly due to lacking manual dexterity and to not realizing that the leaves of a KFM have to be made neatly and suspended as specified. As a result of this field test, more and better photographs have been included, and precision has been stressed in the subsequently improved instructions.

d. The section of the instructions concerned with using a KFM after a nuclear attack was first developed by studying basic scientific sources* and by obtaining estimates from Oak Ridge National Laboratory health physicists involved in the continuing studies of the Hiroshima and Nagasaki survivors, regarding the reduction in life expectancy likely to result from a whole-body external gamma dose of 100 R received in two weeks. Members of pertinent study groups for ERDA and NASA, including Dr. C. C. Lushbaugh of the Oak Ridge Institute of Nuclear Studies and Dr. Douglas Grahn of Argonne National Laboratory, were consulted for additional information regarding updated estimates of

- (1) the midlethal dose for persons lacking medical care and subject to infections after a nuclear attack,
- (2) a daily radiation dose that could be tolerated for weeks by healthy persons able to measure and control the daily dose they receive, and
- (3) the median life shortening to be expected from daily doses too small to cause early lethality.

* Readers interested in more reliable estimates of radiation hazards that are available in the civil defense publications of any nation should study: (1) Ionizing Radiation: Levels and Effects, Volume II, Effects, United Nations, New York, 1972; (2) The Effects on Populations of Exposure to Low Levels of Ionizing Radiation, Report of the Advisory Committee on the Biological Effects of Ionizing Radiations, Division of Medical Sciences, National Academy of Sciences, National Research Council, Washington, DC 20006, November 1972; (3) A Twenty-Year Review of Medical Findings in a Marshallese Population Accidentally Exposed to Radioactive Fallout, by Robert A. Conard, M.D., "et al.", Brookhaven National Laboratory, Associated Universities, Inc., Upton, New York 11973; and (4) Radiobiological Factors in Manned Space Flight, a 1967 report of the Space Radiation Study Panel of the Life Sciences Committee, Space Science Board, National Academy of Sciences, National Research Council.

The field tests of Section XV of the instructions, "How to Use a **KFM** after a Nuclear Attack," involved three untrained families and two high school sophomore girls working together like a family. Only one of the families had a member with more than a high school education. After studying the instructions for 1½ hours, all four test groups passed a practical half-hour test in which they had to read a **KFM** before and after exposing it, to calculate the doses received in different time intervals, to calculate the permissible times of exposure at the several different dose rates, and to estimate the probable effects of different gamma doses using the simplified guides. All agreed that the numerical examples in the instructions were especially helpful.

Before the fourth of these families used Section XV successfully, three other selected families with no member having more than a high school education refused to accept the test offer. One family refused because the cash offer of \$15 for a two-hour effort plus a \$15 bonus for success was too small. Some members of the other two families apparently were too dubious of their abilities to attempt learning to make calculations involving the mysteries of radiation.

5.2 Objectives of These **KFM** Instructions

a. To make field-tested instructions available to civil defense officials and other concerned citizens. If these instructions are prudently reproduced and distributed in normal times, they should be accompanied by advice to build and learn how to use a **KFM** before a possible war crisis arises.

b. To distribute the **KFM** instructions in the form of **camera-**ready copy that would require minimum time and effort for newspapers to print and distribute as a tabloid supplement -- especially during a possible crisis threatening nuclear war.

c. To encourage concerned persons to make **KFMs**, to practice using them, and possibly to improve both the design of this instrument and the instructions.

5.3 Uses of This Report as Regards Its **KFM** Instructions

a. Persons wishing to make a KFM and using this ORNL report as a guide are urged to leave the complete instructions intact. Four extra pattern pages are included after the last page of the complete instructions. These four extra pages provide enough patterns to build two **KFMs** and can be cut out of this report without damaging the instructions.

b. If copies of the instructions are desired, it is recommended that the following page (entitled "Instructions for Persons Concerned With Reproducing the **KFM** Instructions") and all the pages of INSTRUCTIONS be separated from the rest of this ORNL report and delivered to the newspaper or other organization responsible for reproduction.

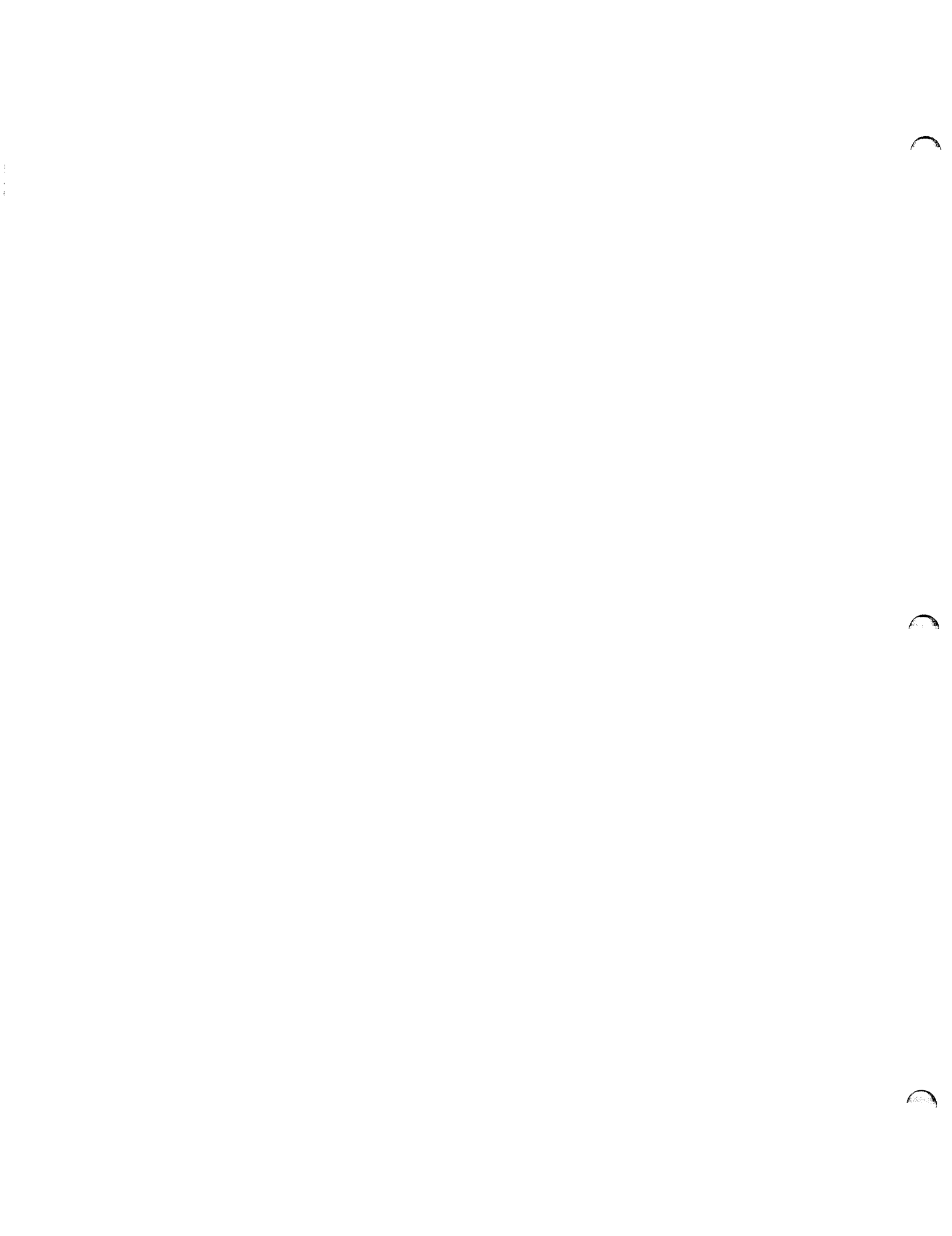

INSTRUCTIONS

(A)

INSTRUCTIONS FOR PERSONS CONCERNED
WITH REPRODUCING THE KFM INSTRUCTIONS

The accompanying materials are provided to assist and expedite the rapid reproduction of the instructions for making and using a KFM. This sheet and the following instruction pages can be given to a newspaper or other organization having means for rapid reproduction, preparatory to mass distribution of this information. No authorization to reproduce this survival information is required.

The paste-ups on the following pages are the right size for almost all tabloids printed by newspapers that publish standard size papers. (If photo reduction is necessary in order to use unusually small sheets, the 4 cut-outs [paste-ups (15), (18), (21) and (24)] and one drawing paste-up (26)] should not be reduced.)

To make the instruction pages fully camera-ready for paste-up and photographing, it is necessary only to remove the page numbers used in this report (such as "INSTRUCTIONS, Page 2") and to cut out the paste-ups.

The tabloid page on which each paste-up is to be placed and the paste-up's identifying number (enclosed in brackets) are printed in blue on each paste-up. For example, on "INSTRUCTIONS, Page 2", printed in blue on paste-up (3) is "Pg 1 - (3)." Since these identification numbers are needed only by the printer, they are printed in blue, a color not reproduced by the photographic process.

The camera-ready copy is for use with a straight lens (100% horizontal and 100% vertical reproduction).

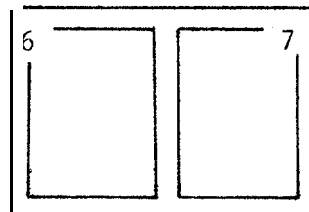
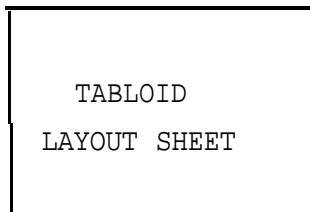

CENTER FOLD
OF A 12-PAGE
TABLOID, INDICATING
TABLOID Page 6 AND
Page 7.

All photographs are 85-line screen.

On the following page is a layout sketch for a 12-page tabloid indicating where each of the numbered paste-ups [(1), (2), --- (40)] should be pasted-up and what spaces should be left blank. This positioning of the paste-ups is necessary to permit a KFM-maker to cut out the patterns without destroying any instructions printed on opposite sides of the 12 tabloid pages.

INSTRUCTIONS
(B)

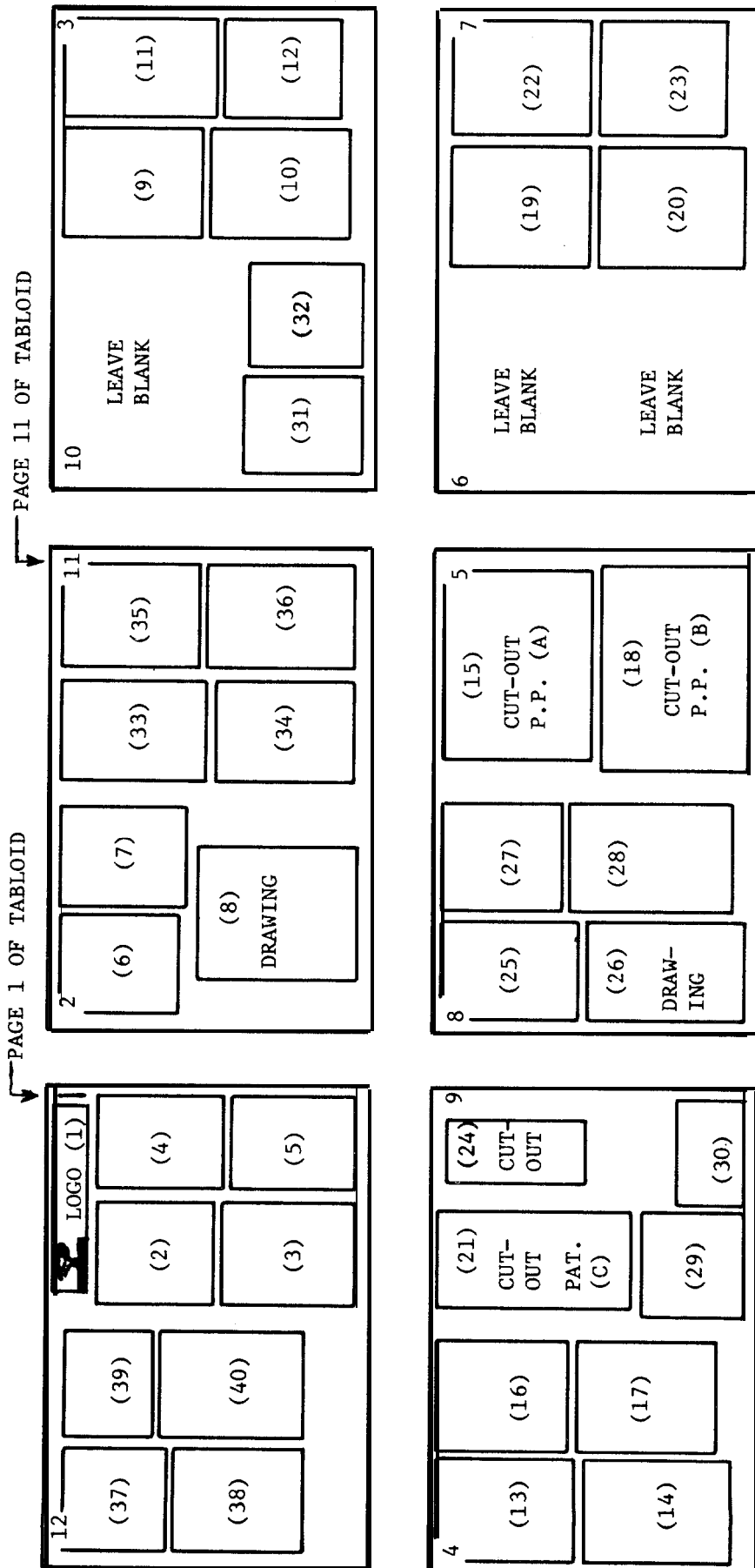

LAYOUT FOR 12-PAGE TABLOID
NUMBERS INSIDE PARENTHESES [(1) THROUGH (40)] ARE PASTE-UPS CUT OUT OF INSTRUCTIONS PAGES

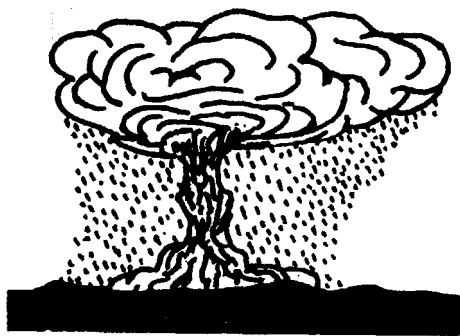

A HOMEMADE FALLOUT METER, THE KFM HOW TO MAKE AND USE IT

Pg 1-(1)

FOLLOWING THESE INSTRUCTIONS MAY SAVE YOUR LIFE



I. The Need for Accurate and Dependable Fallout Meters

If a nuclear war ever strikes the United States, survivors of the blast and fire effects would need to have reliable means of knowing when the radiation in the environment around their shelters had dropped enough to let them venture safely outside. Civil defense teams could use broadcasts of surviving radio stations to give listeners a general idea of the fallout radiation in some broadcast areas. However, the fallout radiation would vary widely from point to point and the measurements would be made too far from most shelters to make them accurate enough to use safely. Therefore, each shelter should have some dependable method of measuring the changing radiation dangers in its own area.

During a possible nuclear crisis that was rapidly worsening, or after a nuclear attack, most unprepared Americans could not buy or otherwise obtain a fallout meter -- an instrument that would greatly improve their chances of surviving a nuclear war. The fact that the dangers from fallout radiation -- best expressed in terms of the radiation dose rate, roentgens per hour (**R/hr**) -- quite rapidly decrease during the first few days, and then decrease more and more slowly, makes it very important to have a fallout meter capable of accurately measuring the unseen, unfelt and changing fallout dangers. Occupants of a fallout shelter should be able to control the radiation doses they receive. In order to effectively control the radiation doses, a dependable measuring instrument is needed to determine the doses they receive while they are in the shelter and while they are outside for emergency tasks, such as going out to get badly needed water. Also, such an instrument would permit them to determine when it is safe to leave the shelter for good.

Pg 1--(2)

Untrained families, guided only by these written instructions and using only low cost materials and tools found in most homes, have been able to make a KFM by working 3 or 4 hours. By studying the operating sections of these instructions for about 1 ½ hours, average untrained families have been able to successfully use this fallout meter to measure dose rates and to calculate radiation doses received, permissible times of exposure, etc.

The KFM (Kearny Fallout Meter) was developed at Oak Ridge National Laboratory. It is understandable, easily repairable, and as accurate as most civil defense fallout meters. In the United States in 1976 a commercially available ion chamber fallout meter that has as high a range as a KFM for gamma radiation dose-rate measurements retailed for \$600.

Before a nuclear attack occurs is the best time to build, test and learn how to use a KFM. However, this instrument is so simple that it could be made even after fallout arrives **provided** that all the materials and tools needed (see lists given in Sections V, VI, and VII) and a copy of these instructions have been carried into the shelter.

II. Survival Work Priorities During a Crisis

Before building a KFM, persons expecting a nuclear attack within a few hours or days and already in the place where they intend to await attack should work with the following priorities: (1) build or improve a high-protection-factor shelter (if possible, a shelter covered with 2 or 3 feet of earth and separate from flammable buildings); (2) make and install a KAP (a homemade shelter-ventilating pump) -- if instructions and materials are available; (3) store at least 15 gallons of water for each shelter occupant -- if containers are available; (4) assemble all materials for one or two **KFM's**; and (5) make and store the drying agent (by heating wallboard gypsum, as later described) for both the KFM and its dry-bucket.

Pg 1--(3)

III. How to Use These Instructions to Best Advantage

1. Read ALOUD all of these instructions **through Section VII**, "Tools Needed," before doing anything else.
2. Next assemble all of the needed materials and tools.
3. Then read ALOUD ALL of each section following Section VII before beginning to make the part described in that section.

A FAMILY THAT FAILS TO READ ALOUD ALL OF EACH SECTION DESCRIBING HOW TO MAKE A PART, BEFORE BEGINNING TO MAKE THAT PART, WILL MAKE AVOIDABLE MISTAKES AND WILL WASTE TIME.

4. Have different workers, or pairs of workers, make the parts they are best qualified to make. For example, a less skilled worker should start making the drying agent (as described in Section VIII) before other workers start making other parts. The most skilled worker should make and install the aluminum-foil leaves (Sections X and XI).
5. Give workers the sections of the instructions covering the parts they are to build--so they can follow the step-by-step instructions, checking off with a pencil each step as it is completed.
6. Discuss the problems that arise. The head of the family often can give better answers if he first discusses the different possible interpretations of some instructions with other family members, including teenagers.
7. After completing one KFM and learning to use it, if time permits make a second KFM--that should be a better instrument.



IV. What a KFM Is and How It Works

A KFM is a simple electrostatic fallout meter with which fallout radiation can be measured accurately. To use a KFM, an electrostatic charge must first be placed on its two separate aluminum-foil leaves. These leaves are insulated by being suspended separately on clean, dry insulating threads.

To take accurate readings, the air inside a KFM must be kept very dry by means of drying agents such as dehydrated gypsum (easily made by heating gypsum wallboard, "sheetrock") or silica gel. (Do not use calcium chloride or other salt.) Pieces of drying agent are placed on the bottom of the ionization chamber (the housing can) of a KFM.

An electrostatic charge is transferred from a homemade electrostatic charging device to the two aluminum-foil leaves of a KFM by means of its charging-wire. The charging-wire extends out through the transparent plastic cover of the KFM.

When the two KFM leaves are charged electrostatically, their like charges (both positive or both negative) cause them to be forced apart. When fallout gamma radiation (that is similar to X rays but more energetic) strikes the air inside the ionization chamber of a KFM, it produces charged ions in this enclosed air. These charged ions cause part or all of the electrostatic charge on the aluminum-foil leaves to be discharged. As a result of losing charge, the two KFM leaves move closer together.

To read the separation of the **lower** edges of the two KFM leaves with one eye, look straight down on the leaves and the scale on the clear plastic cover. Keep the reading eye 12 inches above the SEAT. The KFM should be resting on a horizontal surface. To be sure the reading eye is always at this exact distance, place the lower end of a 12-inch ruler on the SEAT, while the upper end of the ruler touches the eyebrow above the reading eye. It is best to hold the KFM can with one hand and the ruler with the other. Using a flashlight makes the reading more accurate.

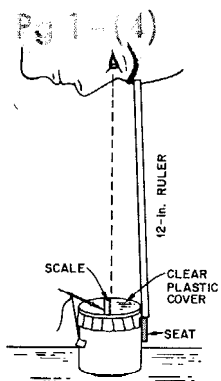
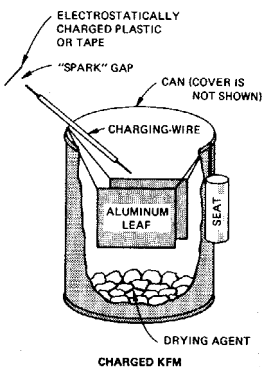

If a KFM is made with the specified dimensions and of the specified materials, its accuracy is automatically and permanently established. Unlike most radiation measuring instruments, a KFM never needs to be calibrated or tested with a radiation source, if made and maintained as specified and used with the following table that is based on numerous calibrations made at Oak Ridge National Laboratory.

The millimeter scale is cut out and attached (see photo illustrations on the following page) to the clear plastic cover of the KFM so that its zero mark is directly above the two leaves in their discharged position when the KFM is resting on a horizontal surface. A reading of the separation of the leaves is taken by noting the number of millimeters that the lower **edge** of one leaf appears to be on, on one side of the zero mark on the scale, and almost at the same time noting the number of millimeters the lower **edge** of the other leaf appears to be on, on the other side of the zero mark. The sum of these two apparent positions of the lower edges of the two leaves is called a KFM reading. The drawing appearing after the photo illustrations shows the **lower** edges of the leaves of a KFM appearing to be 9 mm on the right and zero and 10 on the left, giving a KFM reading of 19 mm. (Usually the lower edges of the leaves are not at the same distance from the zero mark.)

As will be fully explained later, the radiation dose rate is determined by:

- charging and reading the KFM before exposure;
- exposing it to radiation for a specified time in the location where measurement of the dose rate is needed -- when outdoors, holding the KFM about 3 ft. above the ground;
- reading the KFM after its exposure;
- calculating, by subtraction, the **difference** between the reading taken before exposure and the reading taken after exposure;
- using this table to find what the dose rate was during the exposure -- as will be described later.

TABLE USED TO FIND DOSE RATES (R/HR) FROM KFM READINGS

*DIFFERENCE BETWEEN THE READING BEFORE EXPOSURE AND THE READING AFTER EXPOSURE (8-PLY STANDARD-FOIL LEAVES)

DIFF.* IN READ-INGS	TIME INTERVAL OF AN EXPOSURE					
	15 SEC.	1 MIN.	4 MIN.	16 MIN.	1 HR.	R/HR
2 mm	6.2	1.6	0.4	0.1	0.03	
4 mm	12.	3.1	0.8	0.2	0.06	
6 mm	19.	4.6	1.2	0.3	0.08	
8 mm	25.	6.2	1.6	0.4	0.10	
10 mm	31.	7.7	2.0	0.5	0.13	
12 mm	37.	9.2	2.3	0.6	0.15	
14 mm	43.	11.	2.7	0.7	0.18	

Instructions on how to use a KFM are given after those detailing how to make and charge this fallout meter.



To get a clearer idea of the construction and use of a KFM, look carefully at the following photos and read their captions.

- A. An Uncharged KFM. The charging wire has been pulled to one side by its adjustment-thread. This photo was taken looking straight down at the upper edges of the two flat, 8-ply aluminum leaves. At this angle the leaves are barely visible, hanging vertically side by side directly under the zero mark, touching each other and with their ends even. Their suspension-threads insulate the leaves. These threads are almost parallel and touch (but do not cross) each other where they extend over the top of the rim of the can.

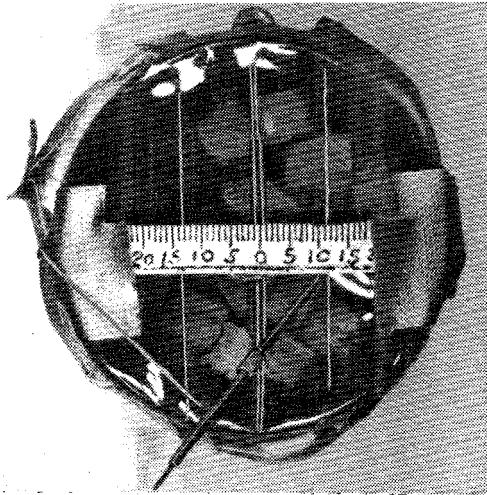

Pg 2--(b)

- B. Charging a KFM by a Spark-Gap Discharge from a Tape That Has Been Electrostatically Charged by Being Unwound Quickly. Note that the charged tape is moved so that its surface is perpendicular to the charging-wire.

The high-voltage electrostatic charge on the unwound tape (that is an insulator) jumps the spark-gap between the tape and the upper end of the charging-wire to charge the insulated aluminum-foil leaves of the KFM. (Since the upper edges of the two leaves are $\frac{3}{4}$ inch below the scale and this is a photo taken at an angle, both leaves appear to be under the right side of the scale.)

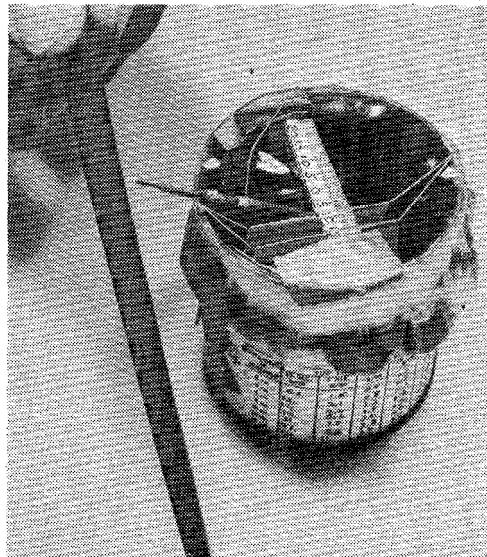

- C. A Charged KFM. Note the separation of the upper edges of its two leaves. The charging-wire has been raised to an almost horizontal position so that its lower end is too far above the aluminum leaves to permit electrical leakage from the leaves back up the charging-wire and into the outside air.

Also note the SEAT, a piece of pencil taped to the right side of the can, opposite the charging wire.

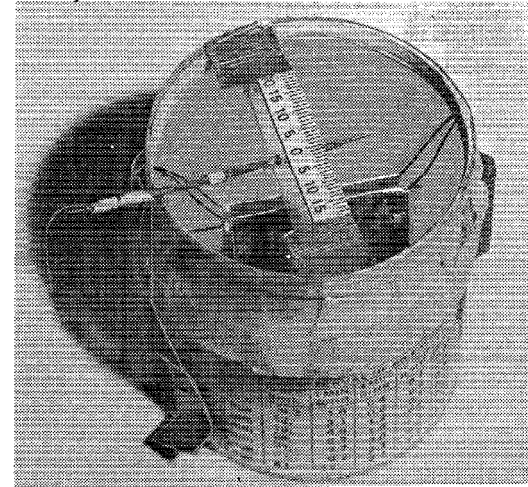

- D. Reading-a KFM. A 12-inch ruler rests on the SEAT and is held vertical, while the reader's eyebrow touches the upper end of the ruler. The lower edge of the right leaf is under 8 on the scale and the lower edge of the left leaf is under 6 on the scale, giving a KFM reading of 14.

For accurate radiation measurements, a KFM should be placed on an approximately horizontal surface, but the charges on its two leaves and their displacements do not have to be equal.

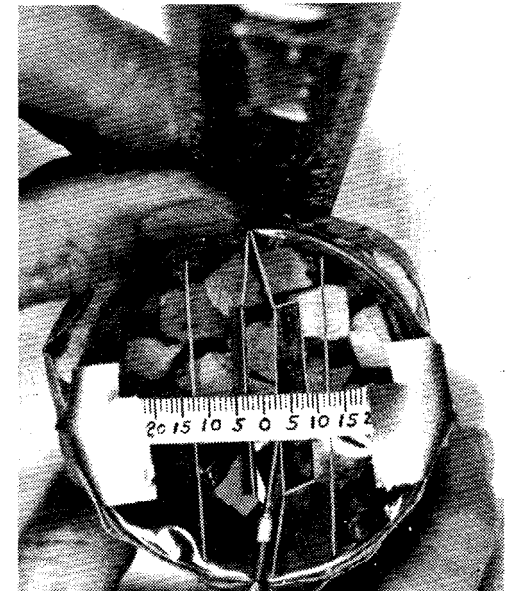



ORNL-DWG 75-11588R

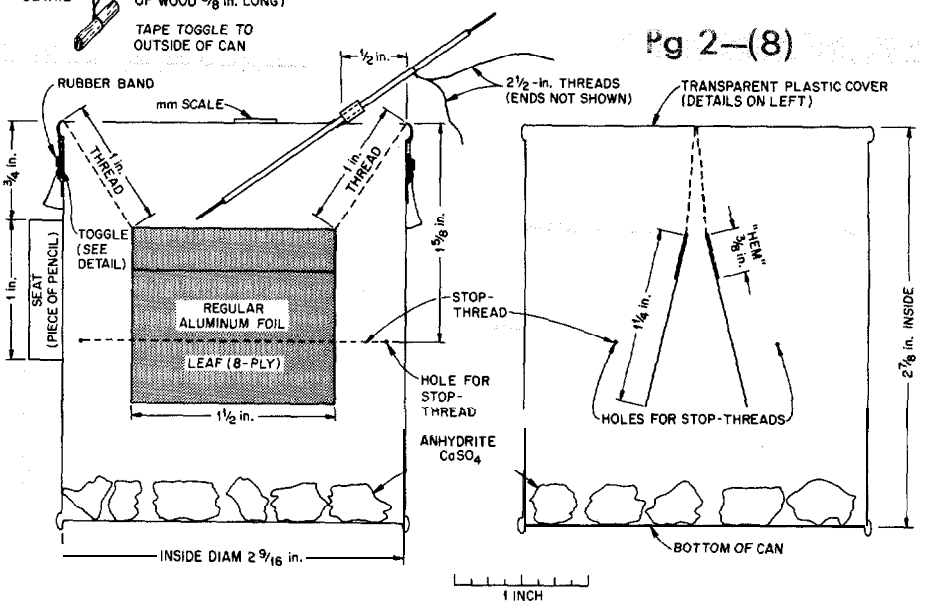
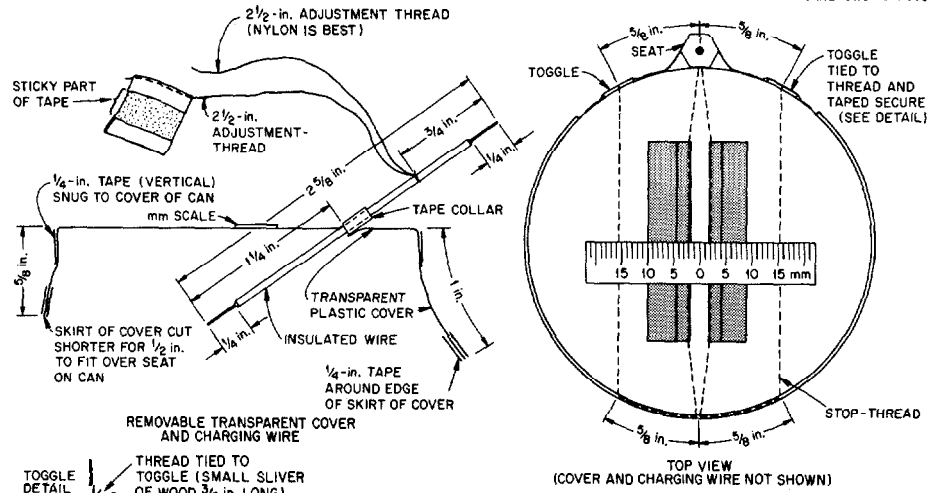

Pg 2-(8)

(This is not a Full Scale Drawing).



V. Materials Needed

- A. For the KFM: (In the following list, when more than one alternative material is given, the **best** material is listed first.)
1. Any type metal can, approximately **2-9/16** inches in diameter inside and **2-7/8** inches high inside, washed clean with soap. (This is the size of a standard S-ounce can. Since most soup cans, pop cans, and beer cans also are about **2-9/16** inches in diameter inside, the required size of can can also be made by cutting down the height of more widely available cans -- as described in Section IX of these instructions.)
 2. Standard aluminum foil -- 2 square feet. (In 1977, 2 square feet of a typical American aluminum foil weighed about 8.2 grams -- about 0.29 oz.) (If only "Heavy Duty" or "Extra Heavy Duty" aluminum foil is available, make S-ply leaves rather than 8-ply leaves of standard foil; the resultant fallout meter will be almost as accurate.)
 3. Doorbell-wire, or other light insulated wire (preferably but not necessarily a single-strand wire inside the insulation) -- **6** inches.
 4. Any type of lightweight thread (preferably but not necessarily nylon). (Best is twisted nylon thread; next best, **unwaxed** lightweight nylon dental floss; next best, silk; next best, polyester.) -- 3 feet. (Thread should be **CLEAN**, preferably not having been touched with fingers. Monofilament nylon is too difficult to see, handle, and mark.) **Pg 3--(9)**
 5. A piece of clear plastic -- a 6 x 6 inch square. Strong polyethylene (4 mils thick) used for storm-proofing windows is best, but any reasonably stout and rather clear plastic will serve. The strong clear plastic used to wrap pieces of cheese, if washed with hot water and soap, is good. Do not use weak plastic or cellophane.
 6. Cloth duct tape ("silver tape"), or masking tape, or freezer tape, or Scotch-type tape -- about 10 square inches. (Save at least 10 feet of Scotch Magic Transparent Tape for the charging device.)
 7. Band-Aid tape, or masking tape, or freezer tape, or Scotch transparent tape, or other thin and very flexible tapes -- about 2 square inches.
 8. Gypsum wallboard (sheetrock) -- about **1/2** square foot, best about **1/2** inch thick. (To make the essential drying agent.)
 9. Glue -- not essential, but useful to replace Band-Aid and other thin tapes. "One hour" epoxy is best. Model airplane cement is satisfactory.
 10. **An ordinary** wooden pencil and a small toothpick (or split a small sliver of wood).
 11. Two strong rubber bands, or string.
- B. For the Charging Devices:
1. Most hard plastic rubbed on dry paper. This is the best method.
 - a. Plexiglas and most other hard plastics, such as are used in drafts-men's triangles, common smooth plastic rulers, etc. -- at least 6 inches long.
 - b. **Dry** paper -- **Smooth** writing or typing paper. Tissue paper, newspaper, or facial tissue such as Kleenex, or toilet paper are satisfactory for charging, but not as durable.
 2. Scotch Magic Transparent Tape (**3/4** inch width is best), or Scotch Transparent Tape, or P.V.C. (Polyvinyl chloride) insulating electrical tapes, or a few of the other common brands of Scotch-type tapes. (Some plastic tapes do not develop sufficiently high-voltage electrostatic charges when unrolled quickly.) This method cannot be used for charging a KFM inside a dry-bucket, needed for charging when the air is very humid.
- C. For Determining Dose Rates and Recording Doses Received: **Pg 3--(10)**
1. A watch -- preferably with a second hand.
 2. A flashlight or other light, for reading the KFM in a dark shelter or at night.
 3. Pencil and paper -- preferably a notebook.
- D. For the Dry-Bucket: (A KFM must be charged inside a dry-bucket if the air is very humid, as it often is inside a crowded, long-occupied shelter lacking adequate forced ventilation.)
1. A large bucket, pot, or can, preferably with a top diameter of at least 11 inches.
 2. Clear plastic (best is **4-mil-thick** clear plastic used for storm windows). A square piece 5 inches wider on a side than the diameter of the bucket to be used.
 3. Cloth duct tape, one inch wide and 8 feet long (or 4 ft., if 2 inches wide). Or 16 ft. of freezer tape one inch wide.



4. Two plastic bags 14 to 16 inches in circumference, such as ordinary plastic bread bags. The original length of these bags should be at least 5 inches greater than the height of the bucket.
5. About one square foot of wall board (sheetrock), to make anhydrite drying agent.
6. Two 1-quart Mason jars or other airtight containers, one in which to store anhydrite and another in which to keep dry the KFM charging devices.
7. Strong rubber bands -- enough to make a loop around the bucket. Or string.
8. Four square feet of aluminum foil, to make a vapor-proof cover -- useful, but not essential.

VI. Useful but not Essential Materials
--Which Could be Obtained Before a Crisis--

1. An airtight container (such as a large peanut butter jar) with a mouth at least 4 inches wide, in which to keep a KFM, along with some drying agent, when it is not being used. Keeping a KFM very dry greatly extends the time during which the drying agent **inside** the KFM remains effective.
2. Commercial anhydrite with a color indicator, such as the drying agent Drierite. This granular form of anhydrite remains light blue as long as it is effective as a drying agent. Obtainable from laboratory supply sources.

Pg 3- (11)

VII. Tools Needed

Small nail - sharpened
 Stick, or a wooden tool handle
 (best 2-2½ inch diameter and at least 12 inches long)
 Hammer
 Pliers
 Scissors
 Needle - quite a large sewing needle, but less than 2% inches long
 Knife with a small blade -- sharp
 Ruler (12 inches)

VIII. Make the Drying Agent

-- The Easiest Part to Make, but Time Consuming --

1. For a KFM to measure radiation accurately, the air inside its ionization chamber must be kept very dry. An excellent drying agent (anhydrite) can be made by heating the gypsum in ordinary gypsum wallboard (sheetrock). Do NOT use calcium chloride.
2. Take a piece of gypsum wallboard approximately 12 inches by 6 inches, and preferably with its gypsum about 3/8 inches thick. Cut off the paper and glue, easiest done by first wetting the paper. [Since water vapor from normal air penetrates the plastic cover of a KFM and can dampen the anhydrite and make it ineffective in as short a time as two days, fresh batches of anhydrite must be made before the attack and kept ready inside the shelter for replacement. The useful life of the drying agent inside a KFM can be greatly lengthened by keeping the KFM inside an airtight container (such as a peanut butter jar with a 4-inch-diameter mouth) with some drying agent, when the KFM is not being used.]

Pg 3 (12)

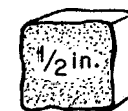

3. Break the white gypsum filling into small pieces and make the largest no more than 1/2 in. across. (The tops of pieces larger than this may be too close to the aluminum foil leaves.) If the gypsum is dry, using a pair of pliers makes breaking it easier. Make the largest **side** of the largest pieces no bigger than this.
4. Dry gypsum is **not** a drying agent. To drive the water out of the gypsum molecules and produce the drying agent (anhydrite), heat the gypsum in an oven at its **highest** temperature (which should be above 400 degrees **F**) for one hour. Heat the gypsum after placing the small pieces no more than two pieces deep in a pan. Or heat the pieces over a fire for 20 minutes or more in a pan or can heated to a dull red.
5. If **sufficient** aluminum foil and time are available, it is best to heat the gypsum and store the anhydrite as follows:
 - a. So that the right amount of anhydrite can be taken quickly out of its storage jar, put enough pieces of gypsum in a can with the same diameter as the KFM, measuring out a batch of gypsum that almost covers the bottom of the can with a single layer.
 - b. Cut a piece of aluminum foil about 8 in. x 8 in. square, and fold up its edges to form a bowl-like container in which to heat one batch of gypsum pieces.
 - c. Measure out 10 or 12 such batches, and put each batch in its aluminum foil "bowl."
 - d. Heat all of these filled "bowls" of gypsum in hottest oven for one hour.



- e. As soon as the aluminum foil is cool enough to touch, fold and crumple the edges of each aluminum foil "bowl" together, to make a rough aluminum-covered "ball" of each batch of anhydrite.
 - f. Promptly seal the batches in airtight jars or other airtight containers, and keep containers closed except when taking out an aluminum-covered "ball."
6. Since anhydrite absorbs water from the air very rapidly, quickly put it in a dry airtight container while it is still quite hot. A Mason jar is excellent.
 7. To place anhydrite in a KFM, drop in the pieces one by one, being careful not to hit the leaves or the stop-threads. The pieces should almost cover the bottom of the can, with no piece on top of other pieces.
 8. To remove anhydrite from a KFM, use a pair of scissors or tweezers as forceps, holding them in a vertical position and not touching the leaves.

IX. Make the Ionization Chamber of the KFM

(To Avoid Mistakes and Save Time,
Read All of This Section ALOUD Before Beginning Work.)

1. Remove the paper label (if any) from an ordinary 8-ounce can from which the top has been smoothly cut. Wash the can with soap and water and dry it. (An 8-ounce can has an inside diameter of about 2-9/16 inches and an inside height of about 2-7/8 inches.)

Pg 4-(13)

2. Skip to step 3 if an 8-ounce can is available. If an 8-ounce can is not available, reduce the height of any other can having an inside diameter of about 2-9/16 inches (such as most soup cans, most pop cans, or most beer cans). To cut off the top part of a can, first measure and mark the line on which to cut. Then to keep from bending the can while cutting, wrap newspaper tightly around a stick or a round wooden tool handle, so that the wood is covered with 20 to 30 thicknesses of paper and the diameter (ideally) is only slightly less than the diameter of the can.

One person should hold the can over the paper-covered stick while a second person cuts the can little by little along the marked cutting line. If leather gloves are available, wear them. To cut the can off smoothly, use a file, or use a hacksaw drawn backwards along the cutting line. Or cut the can with a sharp, short blade of a pocketknife by: (1) repeatedly stabbing downward vertically through the can into the paper, and (2) repeatedly making a cut about 1/4 inch long by moving the knife into a sloping position, while keeping its point still pressed into the paper covering the stick.

Next, smooth the cut edge, and cover it with small pieces of freezer tape or other flexible tape.

3. Cut out the PAPER PATTERN TO WRAP AROUND KFM CAN. (Cut one pattern out of the following Pattern Page A.) Glue (or tape) this pattern to the can, starting with one of the two short sides of the pattern. Secure this starting short side directly over the side seam of the can. Wrap the pattern snugly around the can, gluing or taping it securely as it is being wrapped. (If the pattern is too wide to fit flat between the rims of the can, trim a little off its lower edge.)
4. Sharpen a small nail, by filing or rubbing on concrete, for use as a punch to make the four holes needed to install the stop-threads in the ionization chamber (the can). (The stop-threads are insulators that stop the charged aluminum leaves from touching the can and being discharged.)

5. Have one person hold the can over a horizontal stick or a round wooden tool-handle, that ideally has a diameter about as large as the diameter of the can. Then a second person can use the sharpened nail and a hammer to punch four very small holes through the sides of the can at the points shown by the four crosses on the pattern. Make these holes just large enough to run a needle through them, and then move the needle in the holes so as to bend back the obstructing points of metal.

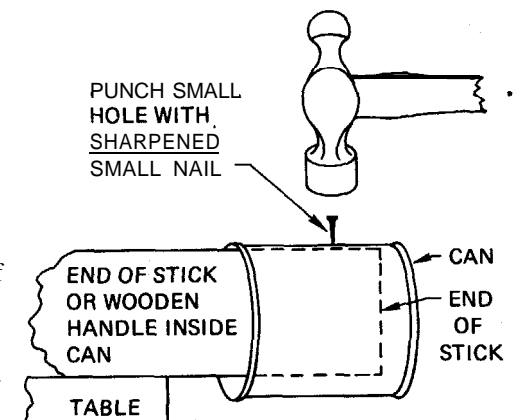

6. The stop-threads can be installed by using a needle to thread a single thread through all four holes. Use a very clean thread, preferably nylon, and do not touch the parts of this thread that will be inside the can and will serve as the insulating stop-threads. Soiled threads are poor insulators. (See illustrations.)

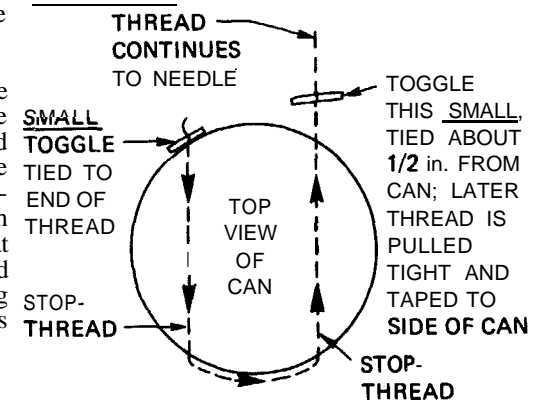

SINGLE THREAD THREADED THROUGH 4 HOLES TO MAKE 2 STOP-THREADS



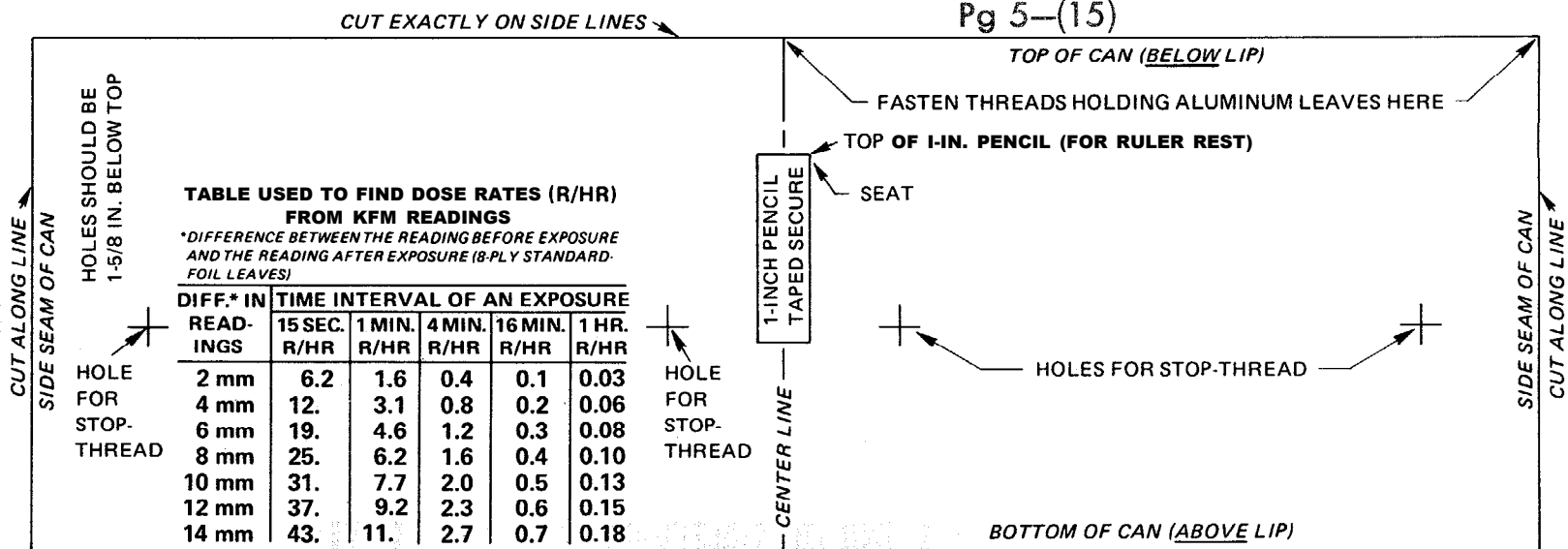
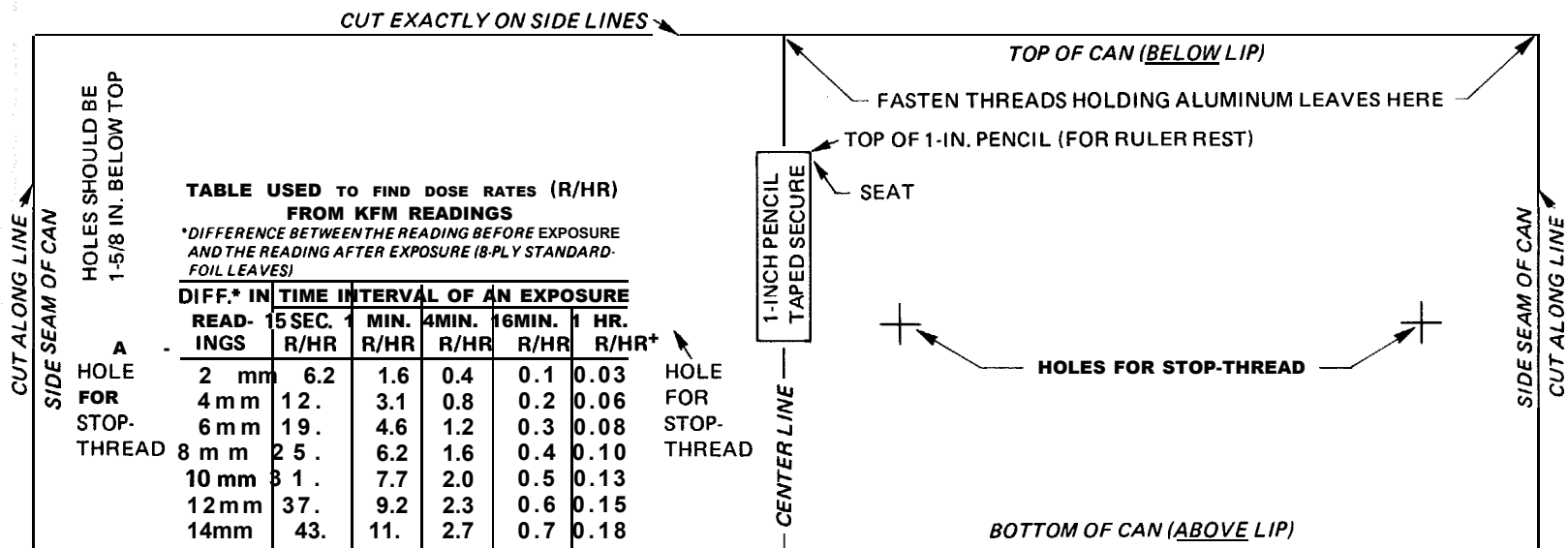

PAPER PATTERN TO WRAP AROUND KFM CAN (GLUE OR TAPE SECURELY TO CAN)

CUT OUT THESE PATTERNS, EACH OF WHICH IS THE EXACT SIZE FOR A KFM.

PATTERN PAGE (A)

CAUTION: XEROX COPIES OF THESE PATTERNS WILL BE TOO LARGE.



1. $\frac{1}{x^2} = x^{-2}$
 $\frac{d}{dx} x^{-2} = -2x^{-3} = -\frac{2}{x^3}$

2. $\frac{d}{dx} \ln x = \frac{1}{x}$
 $\frac{d}{dx} \ln x^2 = \frac{1}{x^2} \cdot 2x = \frac{2}{x}$

3. $\frac{d}{dx} \ln(x^2 + 1) = \frac{1}{x^2 + 1} \cdot 2x = \frac{2x}{x^2 + 1}$
 $\frac{d}{dx} \ln(x^2 - 1) = \frac{1}{x^2 - 1} \cdot 2x = \frac{2x}{x^2 - 1}$

Before threading the thread through, the four holes, tie a **small** toggle (see the preceding sketch) to the long end of the thread. (This toggle can easily be made of a very small sliver of wood cut about 3/8 in. long.) After the thread has been pulled through the four holes, attach a second toggle to the thread, about 1/2 inch from the part of the thread that comes out of the fourth hole. Then the thread can be pulled tightly down the side of the can and the second small toggle can be taped securely in place to the side of the can. (If the thread is taped down without a toggle, it is likely to move under the tape.)

The first toggle and all of the four holes also should be covered with tape, to prevent air from leaking into the can after it has been covered and is being used as an ionization chamber.

Pg 4—(16)

X. Make Two Separate 8-Ply Leaves of Standard [Not Heavy Duty*] Aluminum Foil

Proceed as follows to make each leaf:

Cut out a piece of standard aluminum foil approximately 4 inches by 8 inches.

Fold the aluminum foil to make a 2-ply (= 2 thicknesses) sheet approximately 4 inches by 4 inches.

Fold this 2-ply sheet to make a 4-ply sheet approximately 2 inches by 4 inches.

Fold this 4-ply sheet to make an 8-ply sheet (8 sheets thick) approximately 2 inches by 2 inches, being sure that the two halves of the second-fold edge are exactly together. This third folding makes an 8-ply aluminum foil sheet with **one corner exactly square**.

Cut out the FINISHED-LEAF PATTERN, found on the following Pattern Page B. Note that this pattern is **NOT** a square and that it is **smaller** than the 8-ply sheet. Flatten the 8 thicknesses of aluminum foil with the fingers until they appear to be a single thin, flat sheet.

Hold the FINISHED-LEAF PATTERN on **top of** the 8-ply aluminum foil sheet, with the pattern's THIRD-FOLD EDGE on top of the third-fold edge of the 8-ply aluminum sheet. Be sure that one lower **corner** of the FINISHED-LEAF PATTERN is on top of the **exactly square corner** of the 8-ply aluminum sheet.

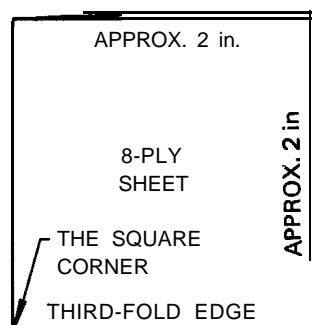

7. While holding a straight edge along the **THREAD LINE** of the pattern, press with a sharp pencil so as to make a shallow groove for the **THREAD LINE** on the 8-ply aluminum sheet. Also using a sharp pencil, trace around the top and side of the pattern, so as to indent (groove) the 8-ply foil.

8. Remove the pattern, and cut out the 8-ply aluminum foil leaf.

9. While holding a straight edge along the indented **THREAD LINE**, lift up the **OPEN EDGE** of the 8-ply sheet (keeping all 8 plies together) until this edge is vertical, as illustrated. Remove the straight edge, and fold the 8-ply aluminum along the **THREAD LINE** so as to make a **flat-folded** hem.

10. Open the flat-folded hem of the finished leaf until the 8-ply leaf is almost flat again, as shown by the pattern, from which the **FINISHED-LEAF PATTERN** has already been cut.

11. Prepare to attach the aluminum-foil leaf to the thread that will suspend it inside the KFM.

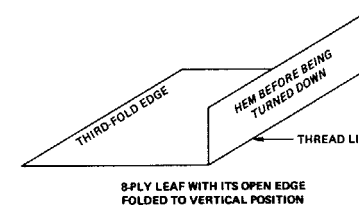
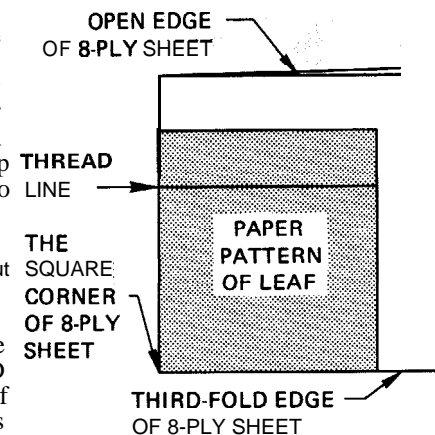

8-PLY LEAF WITH ITS OPEN EDGE FOLDED TO VERTICAL POSITION

Pg 4—(17)

*If only heavy duty aluminum foil (sometimes called "extra heavy duty") is available, make S-ply leaves of the same size, and use the table for the 8-ply KFM to determine radiation dose rates. To make a S-ply leaf, start by cutting out a piece of foil approximately 4 inches by 4 inches. Fold it to make a 4-ply sheet approximately 2 inches by 2 inches, with one corner exactly square. Next from a single thickness of foil cut a square approximately 2 inches by 2 inches. Slip this square into a 4-ply sheet, thus making a S-ply sheet. Then make the S-ply leaf, using the FINISHED-LEAF PATTERN, etc. as described for making an 8-ply leaf.



PATTERN FOR CLEAR-PLASTIC COVER FOR KFM CAN

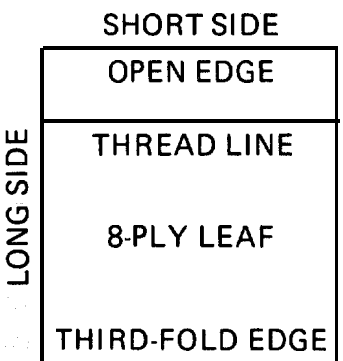
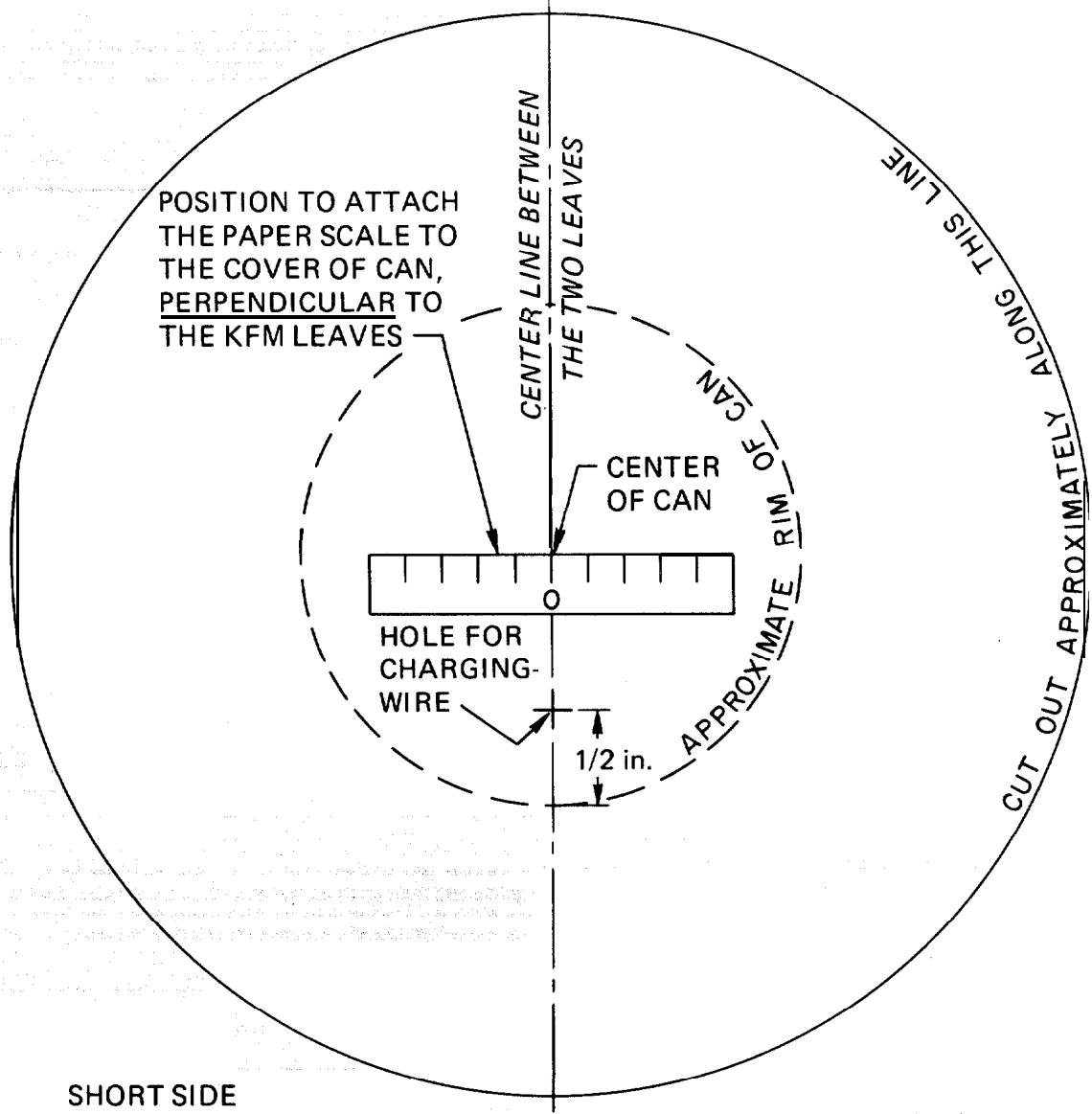

FINISHED-LEAF PATTERN
(CUT OUT EXACTLY ON SIDE LINES)

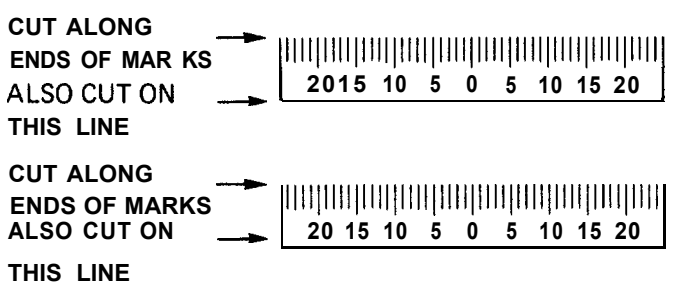

PAPER SCALE (TO BE CUT OUT)

Pg 5-(18)

PATTERN PAGE (B)

CAUTION: XEROX COPIES OF THE FINISHED-LEAF AND THE SCALE PATTERNS WILL BE SLIGHTLY TOO LARGE.



If no epoxy glue* is available to hold down the hem and prevent the thread from slipping in the hem, cut two pieces of tape (Band-Aid tape is best; next best is masking or freezer tape; next best, Scotch tape). After first peeling off the paper backing of Band-Aid tape, cut each piece of tape 1/8 inch by 1 inch long. Attach these two pieces of tape to the finished 8-ply aluminum leaf with the sticky sides up, except for their ends. As shown by the pattern on the following pattern page, secure 1/8 inch of one end of a tape strip near one corner of the 8-ply aluminum foil leaf by first turning under this 1/8-inch end; that is, with this end's sticky side down. Then turn under the other 1/8-inch-long end, and attach this end below the THREAD LINE. **Slant** each tape strip as illustrated on Pattern (C).

Pg 7--(19)

Be sure you have read through step 18 before you do anything else.

- Cut an 8-1/2-inch piece of fine, unwaxed, very clean thread. (Nylon twisted thread, unwaxed extra-fine nylon dental floss, or silk thread are best in this order. Nylon monofilament "invisible" thread is an excellent insulator but is too difficult for most people to handle.)

Cut out Pattern (C), the guide sheet used when attaching a leaf to its suspending thread. Then tape Pattern (C) to the top of a work table. Cover the two "TAPE HERE" rectangles on Pattern (C) with pieces of tape, each piece the size of the rectangle. Then cut two other pieces of tape each the same size and use them to tape the **thread** ONTO the guide sheet, on top of the "TAPE HERE" rectangles.

Be very careful **not** to touch the two 1-inch parts of the thread next to the outline of the finished leaf, since oil and dirt even on clean fingers will reduce the electrical insulating value of the thread between the leaf and the top rim of the can.

- With the thread still taped to the paper pattern and while slightly lifting the thread with a knife tip held under the center of the thread, slip the finished leaf under the thread and into position exactly on the top of the leaf outlined on the pattern page. Hold the leaf in this position with two fingers.
- While keeping the thread straight between its two taped-down ends, lower the thread so that it sticks to the two plastic strips. Then press the thread against the plastic strips.
- With the point of the knife, hold down the center of the thread against the center of the THREAD LINE of the leaf. Then, with two fingers, carefully fold over the hem and press it almost flat. Be sure that the thread comes out of the corners of the hem. Remove the knife, and press the hem down completely flat against the rest of the leaf.
- Make small marks on the thread at the two points shown on the pattern page. Use a ballpoint pen if available.

- Loosen the second two small pieces of tape from the pattern paper, but leave these tapes stuck to the thread.
- Cut 5 pieces of Band-Aid tape, each approximately 1/8 inch by 1/4 inch, this small.



Use 3 of these pieces of tape to secure the centers of the side edges of the leaf. Place the S pieces as illustrated in the SIDE VIEW sketch below.

Pg 7--(20)

ORNL-DWG 76.6542

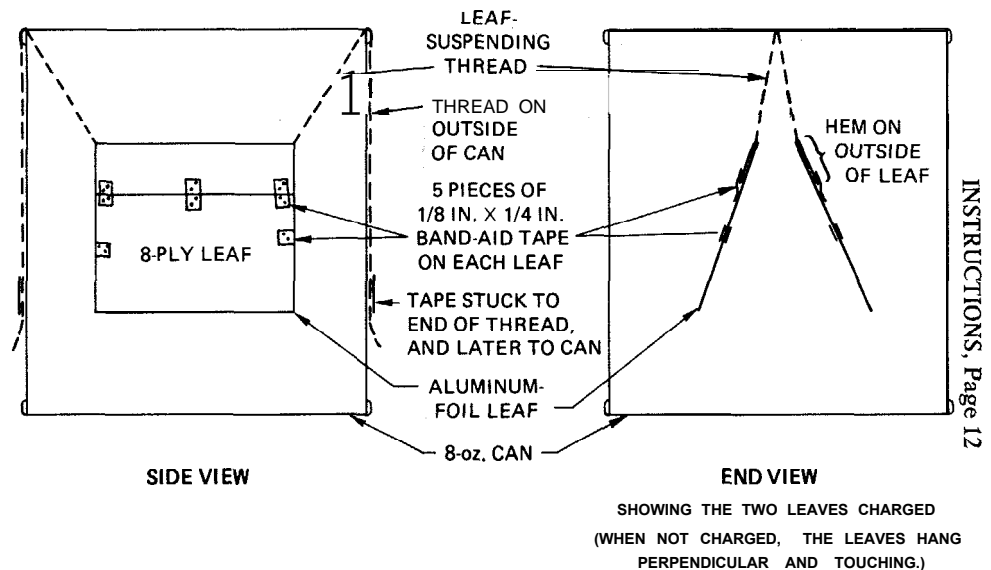

*If using epoxy or other glue, use only a very little to hold down the hem, to attach the thread securely to the leaf and to glue together any open edges of the plied foil. Most convenient is "one hour" epoxy, applied with a toothpick. Model airplane cement requires hours to harden when applied between sheets of aluminum foil. To make sure no glue stiffens the free thread beyond the upper corners of the finished leaf, put no glue within 1/4 inch of a point where thread will go out from the folded hem of the leaf.

The instructions in step 11 are for persons lacking "one hour" epoxy or the time required to dry other types of glue. Persons using glue instead of tape to attach the leaf to its thread should make appropriate use of the pattern on the following page and of some of the procedures detailed in steps 12 through 18.

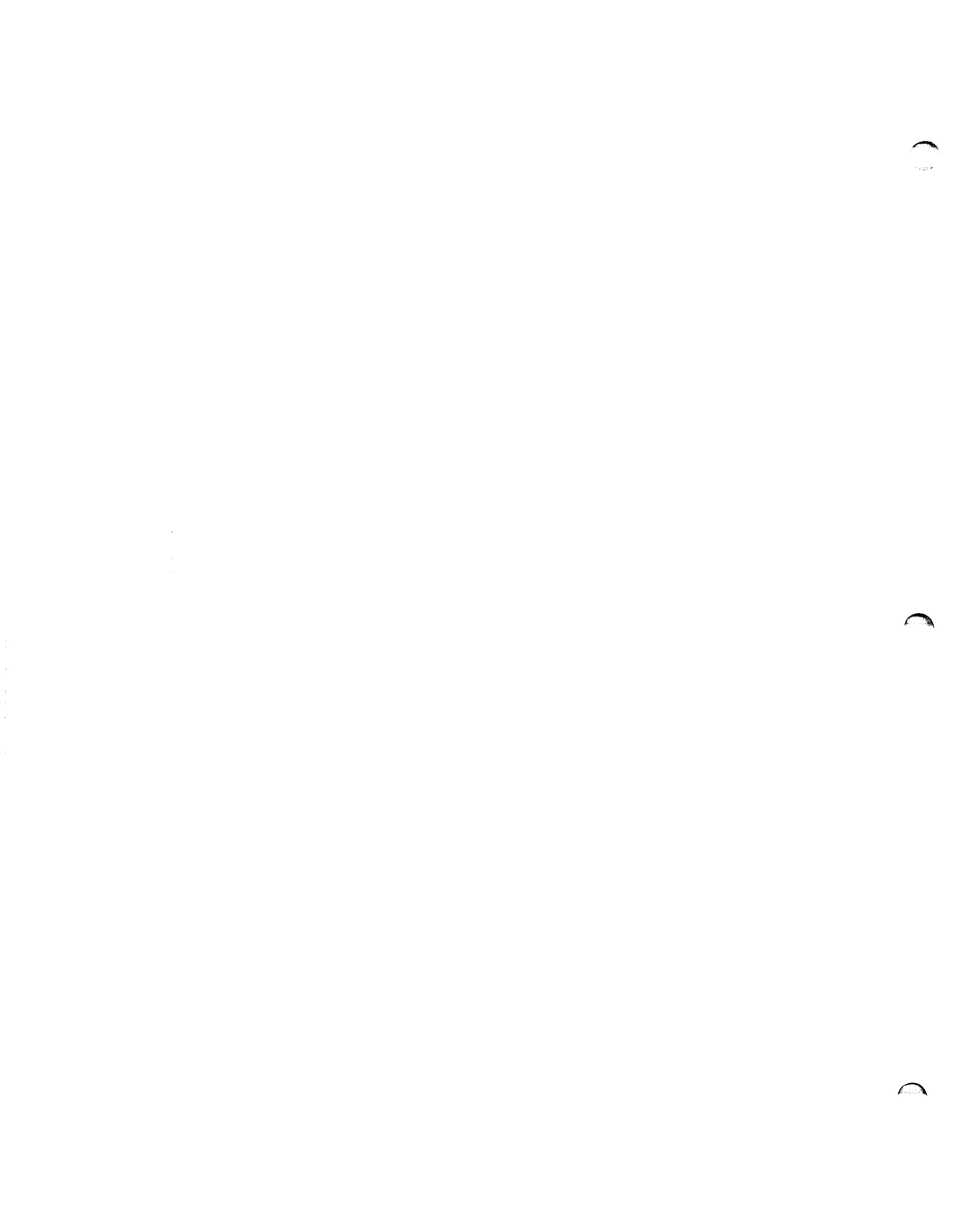

COVER THE TWO "TAPE HERE" RECTANGLES WITH SAME-SIZED PIECES OF TAPE, IN ORDER TO KEEP FROM TEARING THIS PAPER WHEN REMOVING TWO ADDITIONAL PIECES OF TAPE. THEN, BY PUTTING TWO OTHER PIECES OF TAPE THIS SAME SIZE ON TOP OF THE FIRST TWO PIECES, TAPE THE THREAD ONTO THIS GUIDE SHEET, AND LATER ATTACH A LEAF TO THE TAPED-DOWN THREAD.

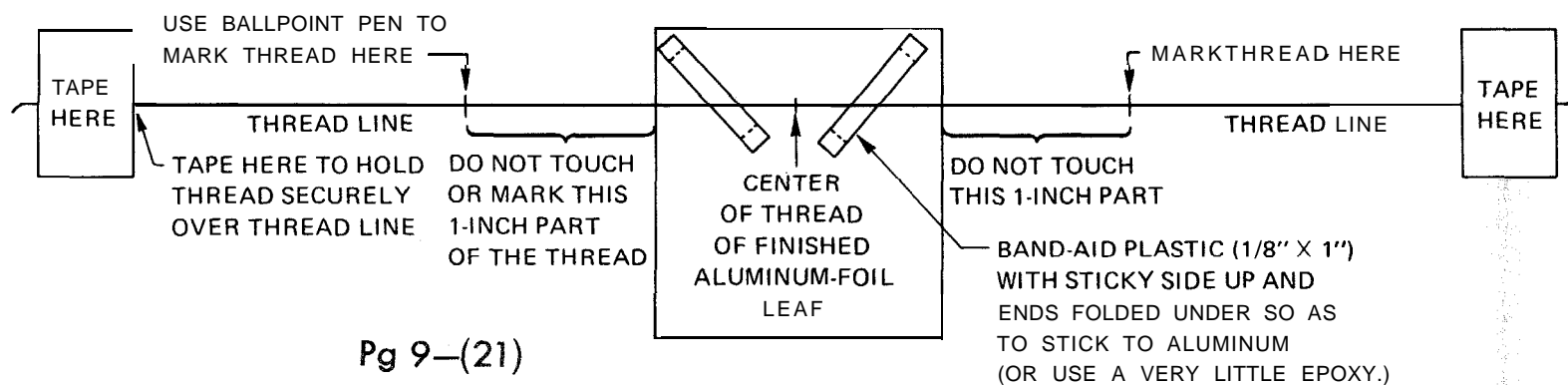

Pg 9-(21)

PATTERN (C)

(Cut out this guide along its border lines and tape to the top of a work table.)

WARNING: The parts of the thread that will be inside the can and on which the leaf will be suspended must serve to insulate the high-voltage electrical charges to be placed on the leaf. Therefore, the suspended parts of the thread must be kept very clean.



XI. Install the Aluminum-Foil Leaves

1. Use the two small pieces of tape stuck to the ends of a leaf-suspending thread to attach the thread to the outside of the can. Attach the tapes on opposite sides of the can, so as to suspend the leaf inside the can. See END VIEW sketch. Each of the two **marks** on the attached thread **MUST rest exactly on the top of the rim of the can**, preferably in two very **small** notches filed in the top of the rim of the can. Each of these two marks on a thread should be positioned exactly above one of the two points shown on the pattern wrapped around the can. Be sure that the hem-side of each of the two leaves faces outward. See END VIEW sketch.
2. Next, the suspending thread of the first leaf should be taped to the top of the rim. Use a piece of Band-Aid only about 1/8 in. x 1/4 in., sticking it to the rim of the can so as barely to cover the thread on the side where the second leaf will be suspended. Make sure no parts of the tapes are inside the can.
3. Position and secure the second leaf, being sure that:
 - a. The smooth sides of the two leaves are smooth (not bent) and face each other and are flush (= "right together") when not charged. See END VIEW sketch and **study** the first photo illustration, "An Uncharged KFM".
 - b. The upper edges of the two leaves are suspended side by side and at the same distance below the top of the can.
 - c. The leaf-suspending threads are taped with Band-Aid to the top of the rim of the can (so that putting the cover on will not move the threads).
 - d. No parts of the leaf-suspending threads inside the can are taped down to the can or otherwise restricted.
 - e. The leaf-suspending parts of the threads inside the can do not cross over, entangle or restrict each other.
 - f. The threads come together on the top of the rim of the can, and that the leaves are flat and hang together as shown in the first photo illustration, "An Uncharged KFM."
 - g. If the leaves do not look like these photographed leaves, make new, better leaves and install them.
4. Cover with tape the parts of the threads that extend down the **outside** of the can, and also cover with more tape the small pieces of tape near the ends of the threads on the outside of the can.

Pg 7-(22)

5. To make the SEAT, cut a piece of a wooden pencil, or a stick, about one inch long and tape it securely to the side of the can along the center line marked SEAT on the pattern. Be sure the upper end of this piece of pencil is at the same position as the top of the location for the SEAT outlined on the pattern. The top of the SEAT is 3/4 inch below the top of the can. Be sure not to cover or make illegible any part of the table printed on the paper pattern.
6. Cut out one of the "Reminders for Operators" and glue and/or tape it to the unused side of the KFM. Then it is best to cover all the sides of the finished KFM with clear plastic tape or varnish. This will keep sticky-tape on the end of an adjustment thread or moisture from damaging the "Reminders" or the table.

XII. Make the Plastic Cover

1. Cut out the paper pattern for the cover from the Pattern Page (B).
2. From a piece of clear, strong plastic, cut a circle approximately the same size as the paper pattern. (Storm-window polyethylene plastic, 4 mils thick, is best.)
3. Stretch the center of this circular piece of clear plastic over the open end of the can, and pull it down close to the sides of the can, making small tucks in the "skirt," so that there are no wrinkles in the top cover. Hold the lower part of the "skirt" in place with a strong rubber band or piece of string. (If another can having the same diameter as the KFM can is available, use it to make the cover -- to avoid the possibility of disturbing the leaf-suspending threads.)

4. Make the cover so it fits snugly, but can be taken off and replaced readily.

Just below the top of the rim of the can, bind the covering plastic in place with a 1/4-inch-wide piece of strong tape. (Cloth duct tape is best. If only freezer or masking tape is available, use two thicknesses.)

Keep vertical the small part of the tape that presses against the rim of the can while pulling the length of the tape horizontally around the can so as to bind the top of the plastic cover snugly to the rim. If this small part of the tape is kept vertical, the lower edge of the tape will not squeeze the plastic below the rim of the can to such a small circumference as to prevent the cover from being removed quite easily.

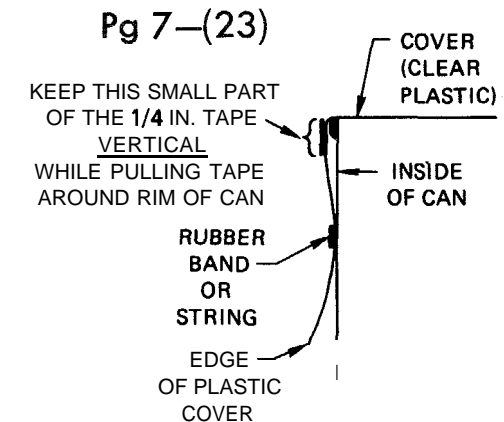



REMINDERS FOR OPERATORS	REMINDERS FOR OPERATORS
<p>THE DRYING AGENT INSIDE A KFM IS O.K. IF, WHEN THE CHARGED KFM IS NOT EXPOSED TO RADIATION, ITS READINGS DECREASE BY 1 MM OR LESS IN 3 HOURS.</p> <p>READING: WITH THE READING EYE 12 INCHES VERTICALLY ABOVE THE SEAT, NOTE ON THE MM SCALE THE SEPARATION OF THE LOWER EDGES OF THE LEAVES. IF THE RIGHT LEAF IS AT 10 MM AND THE LEFT LEAF IS AT 7 MM, THE KFM READS 17 MM. NEVER TAKE A READING WHILE A LEAF IS TOUCHING A STOP-THREAD. NEVER USE A KFM READING THAT IS LESS THAN 5MM.</p> <p>FINDING A DOSE RATE: IF BEFORE EXPOSURE A KFM READS 11 MM AND IF AFTER A 1-MINUTE EXPOSURE IT READS 5 MM, THE DIFFERENCE IN READINGS IS 12 MM, THE ATTACHED TABLE SHOWS THE DOSE RATE WAS 9.6 R/HR DURING THE EXPOSURE.</p> <p>FINDING A DOSE: IF A PERSON WORKS OUTSIDE FOR 3 HOURS WHERE THE DOSE RATE IS 2 R/HR, "RAT IS HIS RADIATION DOSE?" ANSWER: 3 HR x 2 R/HR = 6 R.</p>	<p>FINDING HOW LONG IT TAKES TO GET A CERTAIN R DOSE: IF THE DOSE RATE IS 1.6 R/HR OUTSIDE AND A PERSON IS WILLING TO TAKE A 6 R DOSE, HOW LONG CAN HE REMAIN OUTSIDE? ANSWER: $6 R \div 1.6 R/RR = 3.75 HR = 3 HOURS AND 45 MINUTES.$</p> <p>FALLOUT RADIATION GUIDES FOR A HEALTHY PERSON NOT PREVIOUSLY EXPOSED TO A TOTAL RADIATION DOSE OF MORE THAN 100 R DURING A 2-WEEK PERIOD: 6 R PER DAY CAN BE TOLERATED FOR UP TO TWO MONTHS WITHOUT LOSING THE ABILITY TO WORK.</p> <p>100 R IN A WEEK OR LESS IS NO LIKELY TO SERIOUSLY SICKEN.</p> <p>350 R IN A FEW DAY6 IS LIWLY TO PROVE FATAL UNDER POST-ATTACK CONDITIONS.</p> <p>600 R IN A WEEK OR LESS IS ALMOST CERTAIN TO CAUSE DEATH WITHIN A FEW WEEKS.</p>
	<p>THE DRYING AGENT INSIDE A KFM IS O.K. IF, WHEN THE CHARGED KFM IS NOT EXPOSED TO RADIATION, ITS READINGS DECREASE BY 1 MM OR LESS IN 3 HOURS.</p> <p>READING: WITH THE READING EYE 12 INCHES VERTICALLY ABOVE THE SEAT, NOTE ON THE MM SCALE THE SEPARATION OF THE LOWER EDGES OF THE LEAVES. IF THE RIGHT LEAF IS AT 10 MM AND THE LEFT LEAF IS AT 7 MM, THE KFM READS 17 MM. NEVER TAKE A READING WHILE A LEAF IS TOUCHING A STOP-THREAD. NEVER USE A KFM READING THAT IS LESS THAN 5MM.</p> <p>FINDING A DOSE RATE: IF BEFORE EXPOSURE A KFM READS 17 MM AND IF AFTER A 1-MINUTE EXPOSURE IT READS 5 MM, THE DIFFERENCE IN READINGS IS 12 MM, THE ATTACHED TABLE SHOWS THE DOSE RATE WAS 9.6 R/HR DURING THE EXPOSURE.</p> <p>FINDING A DOSE: IF A PERSON WORKS OUTSIDE FOR 3 HOURS WHERE THE DOSE RATE IS 2 R/HR, "RAT IS HIS RADIATION DOSE?" ANSWER: 3 HR x 2 R/HR = 6 R.</p>



- With scissors, cut off the "skirt" of the plastic cover until it extends only about one inch below the top of the rim of the can.
- Make a notch in the "skirt," about one inch wide, where it tits over the pencil SEAT attached to the can. The "skirt" in this notched area should be only about 5/8 of an inch long, measured down from the top of the rim of the can.
- Remove the plastic cover, and then tape the lower edges of the "skirt," inside and out, using short lengths of 1/4-inch-wide tape. Before securing each short piece of tape, slightly open the tucks that are being taped shut on their edges, so that the "skirt" flares slightly outward and the cover can be readily removed.
- Put the plastic cover on the KFM can. From the Pattern Page (B) cut out the SCALE. Then tape the SCALE to the top of the plastic cover, in the position shown on the pattern for the cover, and also by the drawings. Preferably use transparent tape.

Be careful not to cover with tape any of the division lines on the SCALE between 20 on the right and 20 on the left of 0.

- Make the charging-wire by following the pattern given below which is **exactly the right size**.

Doorbell wire with an outside diameter of about 1/16 inch is best, but any lightweight insulated wire, such as part of a lightweight two-wire extension cord split in half, will serve. The illustrated wire is much thicker than bell wire. To stop tape from possibly slipping up or down the wire, use a very little glue.

Pg 8-(25)

If a very thin plastic has been used for the cover, a sticky piece of tape may need to be attached to the end of the bare-ended adjustment thread, so both threads can be used to hold the charging wire in a desired position.

The best tape to attach to an end of one of the adjustment-threads is cloth duct tape. A square piece 3/4 inch by 3/4 inch is the sticky base. To keep this tape sticky (free of paper fibers), the paper on the can should be covered with transparent tape or varnish. A piece about 1/8 inch by 3/4 inch serves to stick under one end of the sticky base, to hold the adjustment-thread. A 3/4 inch by 1-1/4 inch rectangular piece of tape is used to make the finger hold -- important for making adjustments inside a dry-bucket.

With a needle or pin, make a hole in the plastic cover 1/2 inch from the rim of the can and directly above the upper end of the CENTER LINE between the two leaves. The CENTER LINE is marked on the pattern wrapped around the can. Carefully push the CHARGING-WIRE through this hole (thus stretching the hole) until all of the CHARGING-WIRE below its Band-Aid-tape stop is inside the can.

EXACT SIZE

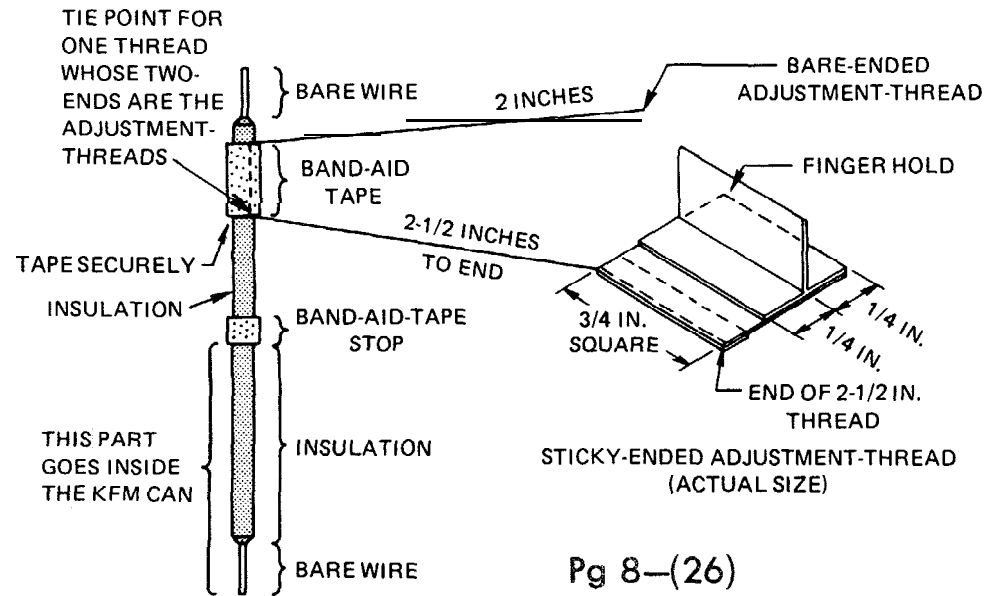

CHARGING-WIRE

(= LIGHT INSULATED WIRE)
(BELL-WIRE IS BEST)

STICKY-ENDED ADJUSTMENT-THREAD (OVERSIZED DRAWING)

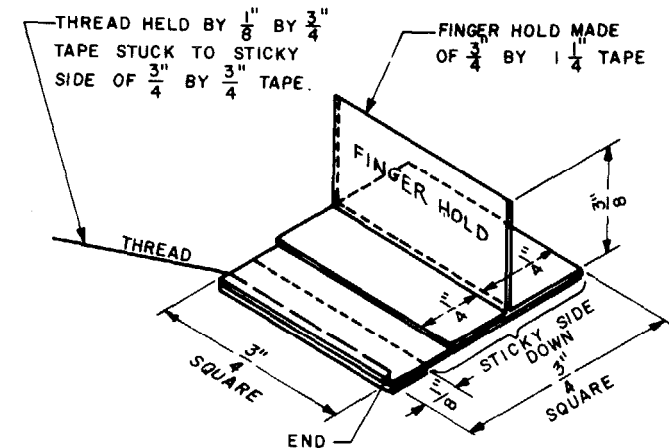



XIII. Two Ways to Charge a KFM

1. Charging a KFM with Hard Plastic Rubbed on Dry Paper.

- a. Adjust the charging-wire so that its lower end is about 1/16 inch above the upper edges of the aluminum-foil leaves. Use the sticky-tape at the end of one adjustment-thread to hold the charging-wire in this position. Stick this tape approximately in line with the threads suspending the leaves, either on the side of the can or on top of the plastic cover. (If the charging-wire is held loosely by the cover, it may be necessary to put a piece of sticky-tape on the end of each adjustment-thread in order to adjust the charging-wire securely. If a charging-wire is not secure, its lower end may be forced up by the like charge on the leaves before the leaves can be fully charged.)

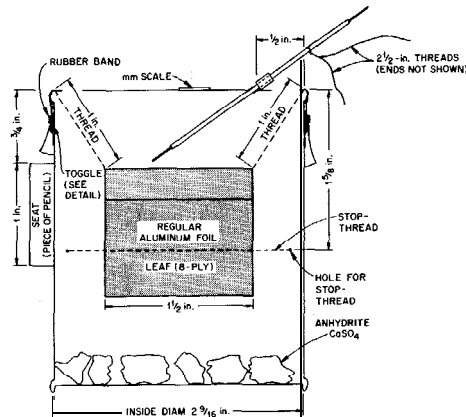

Pg 8--(27)

- b. Select a piece of Plexiglas, a draftsman's plastic triangle, a smooth plastic ruler, or other piece of hard, smooth plastic. (Unfortunately, not all types of hard plastic can be used to generate a **sufficient** electrostatic charge.) Be sure the plastic is dry.

For charging a KFM inside a dry-bucket, cut a rectangular piece of hard plastic about 1-1/2 by 5 inches. Sharp corners and edges can be smoothed by rubbing on concrete. To avoid contaminating the charging end with sweaty, oily fingers, it is best to mark the other end with a piece of tape.

- c. Fold **DRY** paper (typing paper, writing paper, or other smooth, clean paper) to make an approximate square about 4 inches on a side and about 20 sheets thick. (This many sheets of paper lessens leakage to the fingers of the electrostatic charges to be generated on the hard plastic and on the rubbed paper.)

- d. Fold the square of paper in the middle, and move the **hard plastic** rapidly back and forth so that it is rubbed vigorously on the paper in the middle of this folded square -- while the outside of this folded square of paper is squeezed firmly between thumb and the ends of two fingers. To avoid discharging the charge on the plastic to the fingers, keep them away from the edges of the paper. See photo.

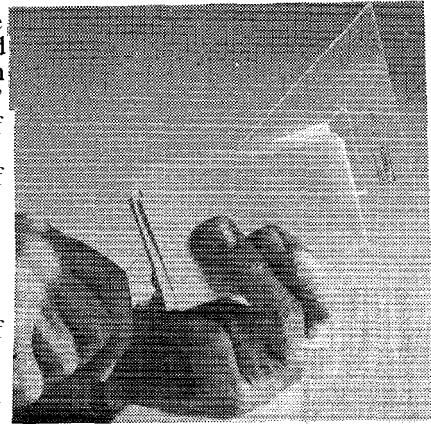

- e. Move the electrostatically charged part of the rubbed plastic rather slowly past the upper end of the charging-wire, while looking straight down on the KFM, -Keep the hard plastic approximately perpendicular to the charging-wire and about 1/4 to 1/2 inch away from its upper end. The charge jumps the spark gaps and charges the leaves of the KFM.

Pg 8--(28)

- f. Pull down on an insulating adjustment-thread to raise the lower end of the charging-wire. (If the charging-wire has been held in its charging position by its sticky-ended adjustment-thread being stuck to the top of the clear plastic cover, to avoid possibly damaging the threads: (1) pull down a little on the bare-ended adjustment-thread; and (2) detach, pull down on, and secure the sticky-ended adjustment-thread to the side of the can, so as to raise and keep the lower end of the charging-wire close to the underside of the clear plastic cover.) Do not **touch the charging-wire**.
- g. Put the charging paper and the hard plastic in a container where they will be kept dry -- as in a Mason jar with some drying agent.

2. Charging a KFM from a Quickly Unwound Roll of Tape. (Quick unwinding produces a harmless charge of several thousand volts on the tape.)

- a. Adjust the charging-wire so that its lower end is about 1/16 inch above the upper edges of the aluminum-foil leaves. Use the sticky-tape at the end of one adjustment-thread to hold the charging-wire in this position. Stick this tape approximately in line with the leaves, either on the side of the can or on the plastic cover. (If the plastic cover is weak, it may be necessary to put a piece of sticky-tape on the end of each adjustment-thread, in order to hold the charging-wire securely. If a charging-wire is not secure, its lower end may be forced up by the like charge on the leaves before the leaves can be fully charged.)



The first part of the document discusses the importance of maintaining accurate records of all transactions. This includes not only sales and purchases but also the flow of goods and services between different departments and locations.

The second part of the document focuses on the role of the accounting department in providing timely and accurate financial information to management. This involves a close working relationship with other departments to ensure that all relevant data is captured and analyzed correctly.



b. The sketch shows the "GET SET" position, preparatory to unrolling the Scotch Magic Transparent Tape, P.V.C. electrical tape, or other tape. Be sure to first remove the roll from its dispenser. Some of the other kinds of tape will not produce a high enough voltage.

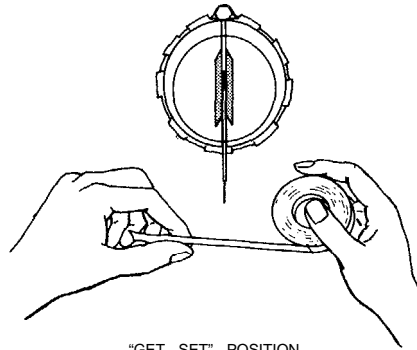

"GET SET" POSITION

Pg 9--(29)

c. QUICKLY unroll 10 to 12 inches of tape by pulling its end with the left hand, while the right hand allows the roll to unwind while remaining in about the same "GET SET" position only an inch or two away from the KFM.

d. While holding the unwound tape tight, about perpendicular to the charging-wire, and about 1/4 inch away from the end of the charging-wire, **promptly** move both hands and the tape to the right **rather slowly** -- taking about 2 seconds to move about 8 inches. The electrostatic charge on the unwound tape "jumps" the spark gaps from the tape to the upper end of the charging-wire and from the lower end of the charging-wire to the aluminum leaves, and charges the aluminum leaves.

Be sure neither leaf is touching a stop-thread.

Try to charge the leaves enough to spread them far enough apart to give a reading of at least 15 mm.

e. Pull down on an insulating adjustment-thread to raise the lower end of the charging-wire. If the charging-wire has been held in charging position by its sticky-ended adjustment-thread being stuck to the top of the clear plastic cover, it is best first to pull down a little on the bare-ended adjustment-thread, and then to move, pull down on, and secure the sticky-ended adjustment-thread to the side of the can so that the lower part of the charging-wire is close to the underside of the clear plastic cover.

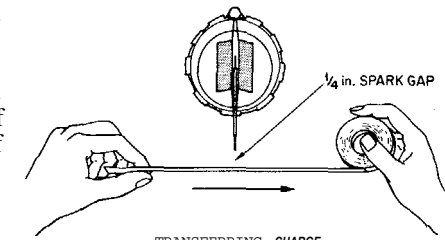

TRANSFERRING CHARGE

Pg 9--(30)

Do not touch the charging-wire.

f. Rewind the tape **tight** on its **roll**, for future use when other tape may not be available.



XIV. Make and Use a Dry-Bucket

By charging a KFM while it is inside a dry-bucket with a transparent plastic cover (see illustration), this fallout meter can be charged and used even if the relative humidity is 100% outside the dry-bucket. The air inside the dry-bucket is kept very dry by a drying agent placed on its bottom. About a cupful of anhydrite serves very well. The pieces of this dehydrated gypsum need not be as uniform in size as is best for use inside a KFM, but do not use powdered anhydrite.

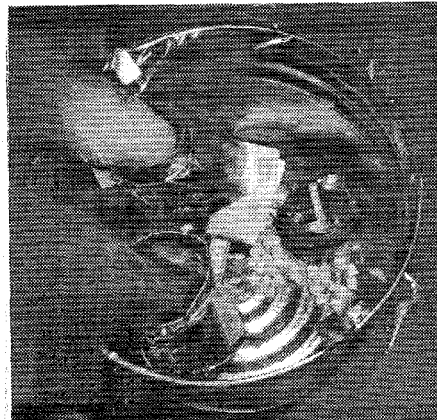

Pg 10--(31)

A dry-bucket can be readily made in about an hour by proceeding as follows:

1. Remove the handle of a large bucket, pot, or can preferably with a top diameter of at least 11 inches. A 4-gallon bucket having a top diameter of about 14 inches is ideal. If the handle-supports interfere with stretching a piece of clear plastic film across the top of the bucket, remove them, being sure no sharp points remain.
2. Cut out a circular piece of clear plastic with a diameter about 5 inches larger than the diameter of the top of the bucket. Clear polyethylene 4 mils thick, used for storm windows, etc., is best. Stretch the plastic smooth across the top of the bucket, and tie it in place, preferably with strong rubber bands looped together to form a circle.
3. Make a plastic top that fits snugly but is easily removable, by taping over and around the plastic just below the top of the bucket. One-inch-wide cloth duct tape, or one-inch-wide glass-reinforced strapping tape, serves well. When taping, do not permit the lower edge of the tape to be pulled inward below the rim of the bucket.

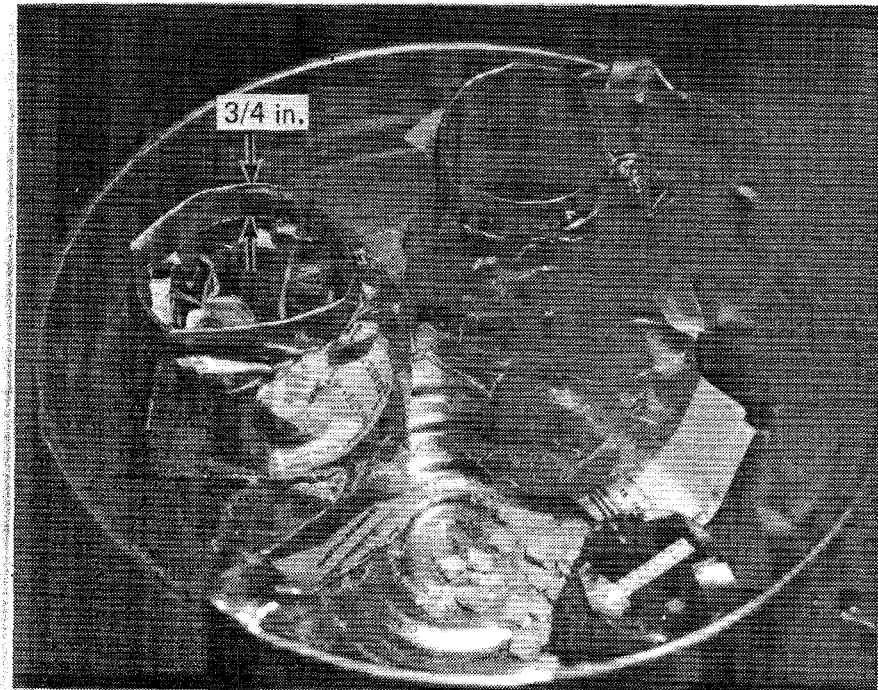

Pg 10--(32)

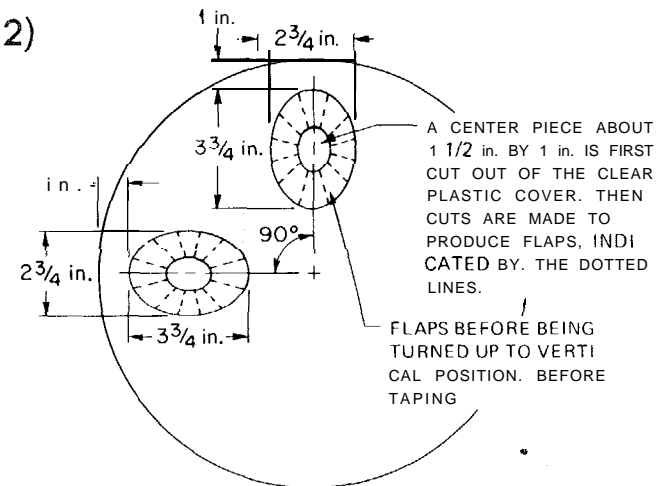



Handwritten text, possibly a signature or name, located in the upper middle section of the page.



4. Cut two small holes (about 1 inch by 2 inches) in the plastic cover, as illustrated. Then make the radial cuts (shown by dotted lines) outward from the small holes, out to the solid-line outlines of the 3 inch by 4 inch hand-holes, so as to form small **flaps**.
5. Fold the small flaps upward, so they are vertical. Then tape them on their outer sides, so they form a vertical "wall" about 3/4 inch high around each hand-hole.
6. Reduce the length of two ordinary plastic bread bags (or similar plastic bags) to a length that is 5 inches greater than the height of the bucket. (Do not use rubber gloves in place of bags; gloves so used result in much more humid outside air being unintentionally pumped into a dry-bucket when it is being used while charging a KFM inside it.)
7. Insert a plastic bag into each hand-hole, and fold the edge of the plastic bag about 1/2 inch over the taped vertical "wall" around each hand-hole.
8. Strengthen the upper parts of the plastic bags by folding 2-inch pieces of tape over the top of the "wall" around each hand-hole.
9. Make about a quart of anhydrite by heating small pieces of wall-board gypsum, and keep this anhydrite dry in a Mason jar or other airtight container with a rubber or plastic sealer.
10. Make a circular aluminum-foil cover to place over the plastic cover when the dry-bucket is not being used for minutes to hours. Make this cover with a diameter about 4 inches greater than the diameter of the top of the bucket, and make it fit more snugly with an encircling loop of rubber bands, or with string. Although not essential, an aluminum-foil cover reduces the amount of water vapor that can reach and pass through the plastic cover, thus extending the life of the drying agent.
11. Charge a KFM inside a dry-bucket by: **Pg 11—(33)**
 - a. Taking off wrist watch and sharp-pointed rings that might tear the plastic bags.
 - b. Placing inside the dry-bucket:
 - (1) About a cup of anhydrite or silica gel;
 - (2) the KFM, with its charging-wire adjusted in its charging position; and
 - (3) dry, folded paper and the electrostatic charging device, best a S-inch-long piece of Plexiglas with smoothed edges, to be rubbed between dry paper folded about 4 inches square and about 20 sheets thick. (Unrolling a roll of tape inside a dry-bucket is an impractical charging method.)

- c. Replacing the plastic cover, that is best held in place with a loop of rubber bands.
 - d. Charging the KFM with your hands inside the plastic bags, operating the charging device. Have another person illuminate the **KFM with** a flashlight. When adjusting the charging-wire, move your hands very slowly. See the dry-bucket photos.
12. Expose the KFM to fallout radiation **either** by:
 - a. Leaving the KFM inside the dry-bucket while exposing it to fallout radiation for one of the listed time intervals, and reading the KFM before and after the exposure while it remains inside the dry-bucket. (The reading eye should be a measured 12 inches above the SEAT of the KFM, and a flashlight or other light should be used.)
 - b. Taking the charged KFM out of the dry-bucket to read it, expose it, and read it after the exposure. (If this is done repeatedly, especially in a humid shelter, the drying agent will not be effective for many KFM chargings, and will have to be replaced.)

xv. **How to Use a KFM after a Nuclear Attack**

A. Background Information

Pg 11—(34)

If during a rapidly worsening crisis threatening nuclear war you are in the place where you plan to take shelter, postpone studying the instructions following this sentence until after you have:

- (1) built or improved a high-protection-factor shelter (if possible, a shelter covered with 2 or 3 ft of earth and separate from flammable buildings), and
- (2) made a KAP (homemade shelter-ventilating pump) if you have the instructions and materials, and
- (3) stored at least 15 gallons of water for each shelter occupant if you can obtain containers.

Having a KFM or any other dependable fallout meter and knowing how to operate it will enable you to minimize radiation injuries and possible fatalities, especially by skillfully using a high-protection-factor fallout shelter to control and limit exposures to radiation. By studying this section you first will learn how to measure radiation **dose rates** (roentgens per hour = R/hr), how to calculate **doses [R]** received in different time intervals, and how to determine time intervals (hours and/or minutes) in which specified doses would be received. Then this section lists the sizes of doses (number of R) that the average person can tolerate without being sickened, that he is likely to survive, and that he is likely to be killed by.



Most fortunately for the future of all living things, the decay of radioactivity causes the **sandlike** fallout particles to become less and less dangerous with the passage of time. Each fallout particle acts much **like** a tiny X ray machine would if it were made so that its rays, shooting out from it **like** invisible light, became weaker and weaker with time.

Contrary to exaggerated accounts of fallout dangers, the radiation dose **rate** from fallout particles when they reach the ground in the areas of the heaviest fallout **will decrease quite rapidly**. For example, consider the decay of fallout from a relatively nearby, large surface burst, at a place where the fallout particles are deposited on the ground one hour after the explosion. At this time one hour after the explosion, assume that the radiation dose rate (the best measure of radiation danger at a particular time) measures 2,000 roentgens per hour (2,000 **R/hr**) outdoors. Seven hours later the dose rate is reduced to 200 **R/hr** by normal radioactive decay. Two days after the explosion, the dose rate outdoors is reduced by radioactive decay to 20 **R/hr**. After two weeks, the dose rate is less than 2 **R/hr**. When the dose rate is 2 **R/hr**, people can go out of a good shelter and work outdoors for 3 hours a day, receiving a daily dose of 6 roentgens, without being sickened.

In places where fallout arrives several hours after the explosion, the radioactivity of the fallout will have gone through its time period of most rapid decay while the fallout particles were still airborne. If you are in a location so distant from the explosion that fallout arrives 8 hours after the explosion, two days must pass before the initial dose rate measured at your location will decay to 1/10 its initial intensity.

B. Finding the **Dose Rate** Pg 11—(35)

1. Reread Section IV, "What a KFM Is and How It Works." Also reread Section XIII, "Two Ways to Charge a KFM," and actually do each step immediately after reading it.
2. Charge the KFM, raise the lower end of its charging-wire and read the apparent separation of the lower edges of its leaves while the KFM rests on an approximately horizontal surface. Never take a reading while a leaf is touching a stop-thread.
3. Expose the KFM to fallout radiation for one of the time intervals shown in the vertical columns of the table attached to the KFM. (Study the following table.) If the dose rate is not known even approximately, first expose the fully charged KFM for one minute. For dependable measurements outdoors, expose the charged KFM about three feet above the ground. For most exposures, connect the KFM to a stick or pole (best done with two rubber bands), and expose it about three feet above the ground. Be careful not to tilt the KFM too much.

4. Read the KFM after the exposure, while the KFM rests on an approximately horizontal surface.
5. Find the time interval that gives a dependable reading -- by exposing the fully charged KFM for one or more of the listed time intervals until the **reading** after the **exposure is**:

(a) Not less than 5 mm. Pg 11—(36)

(b) At least 2 mm less than the reading before the exposure.

6. Calculate by simple subtraction the **difference** in the apparent separation of the **lower** edges of the leaves before the exposure and after the exposure. An example: If the reading before the exposure is 18 mm **and** the reading after the exposure is 6 mm, the **difference** in readings is 18mm - 6 mm = 12 mm.
7. If an exposure results in a difference in readings of less than 2 mm, recharge the KFM and expose it again for one of the longer time intervals listed. (If there appears to be no difference in the readings taken before and after an exposure for one **minute**, this does not prove there is absolutely no fallout danger.)
8. If an exposure results in the reading after the exposure being less **than** 5 mm, recharge the KFM and expose it again for one of the shorter time intervals listed.
9. Use the table attached to the KFM to find the **dose rate (R/hr)** during the time of exposure. The dose rate (R/hr) is found at the intersection of the vertical column of numbers under the time interval used and of the horizontal **line** of numbers that lists the calculated difference in readings at its left end.

TABLE USED TO FIND DOSE RATES (R/HR) FROM KFM READINGS
*DIFFERENCE BETWEEN THE READING BEFORE EXPOSURE AND THE READING AFTER EXPOSURE (BPLY STANDARD FOIL LEAFES).

DIFF. IN READINGS	TIME INTERVAL OF AN EXPOSURE				
	15 SEC.	1 MIN.	4 MIN.	16 MIN.	1 HR.
	R/HR	R/HR	R/HR	R/HR	R/HR
2 mm	6.2	1.6	0.4	0.1	0.03
4 mm	12.	3.1	0.8	0.2	0.06
6 mm	19.	4.6	1.2	0.3	0.08
8 mm	25.	6.2	1.6	0.4	0.10
10 mm	31.	7.7	2.0	0.5	0.13
12 mm	37.	9.2	2.3	0.6	0.15
14 mm	43.	11.	2.7	0.7	0.18

An example: If the time interval of the exposure was **1 MIN.** and the difference in readings was 12 mm, the table shows that the **dose** rate during the time interval of the exposure was 9.2 **R/HR** (9.2 roentgens per hour).

Another example: If the time interval of the exposure was **15 SEC.** and the difference in readings was **11 mm**, the table shows that the dose rate during the exposure **was** halfway between 31 **R/HR** and 37 **R/HR** that is, the **dose rate** was 34 **R/hr**.

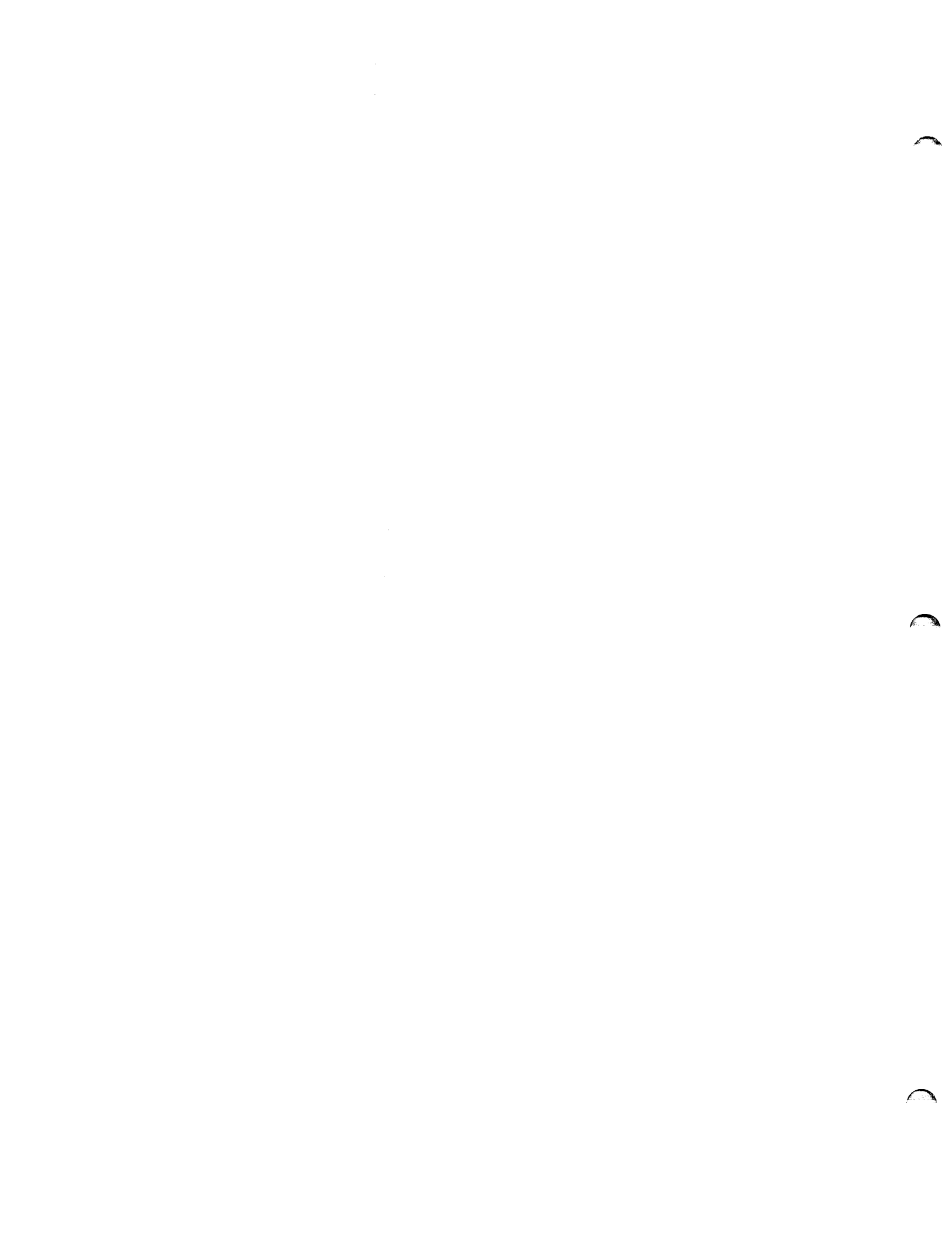

10. Note in the table that if an exposure for one of the listed time intervals causes the **difference** in readings to be 2 mm or 3 mm, then an exposure 4 times as long reveals the same dose rate. An example: If a 1- min exposure results in a difference in readings of 2 mm, the table shows the dose rate was 1.6 R/hr; then if the KFM is exposed for 4 minutes at this same dose rate of 1.6 R/hr, the table shows that the resultant difference in readings is 8 mm.

The longer exposure results in a more accurate determination of the dose rate.

11. If the dose rate is found to be greater than 0.2 R/hr and time is available, recharge the KFM and repeat the dose-rate measurement -- to avoid possible mistakes.

C. Calculating the **Dose Received** Pg 12--(37)

The **dose** of fallout radiation -- that is, the **amount** of fallout radiation received -- determines the harmful effects on men and animals. Being exposed to a high **dose** rate is not always dangerous -- provided the exposure is short enough to result in only a small **dose** being received. For example, if the **dose rate** outside an excellent fallout shelter is 1200 R/hr and a shelter occupant goes outside for 30 seconds, he would be exposed for 1/2 of 1 minute, or 1/2 of 1/60 of an hour, which equals 1/120 hour. Therefore, since the dose he would receive if he stayed outside for 1 hour would be 1200 R, in 30 seconds he would receive 1/120 of 1200, which equals 10 R (1200 R divided by 120 = 10 R). A total daily **dose** of 10 R (10 roentgens) will not cause any symptoms if it is not repeated day after day for a week or more.

In contrast, if the average dose rate of an area were found to be 12 R/hr and if a person remained exposed in that particular area for 24 hours, he would receive a **dose** of 288 R (12 R/hr x 24 hr = 288 R). Even assuming that this person had been exposed previously to very little radiation, there would still be a serious risk that this 288 R **dose** would be fatal under the difficult conditions that would follow a heavy nuclear attack.

Another example: Assume that three days after an attack the occupants of a dry, hot cave giving almost complete protection against fallout are in desperate need of water. The dose rate outside is found to be 20 R/hr. To backpack water from a source 3 miles away is estimated to take 2-1/2 hours. The cave occupants estimate that the water backpackers **will** receive a dose in 2-1/2 hours of 50 R (2.5 hr x 20 R/hr = 50 R). A dose of 50 R will cause only mild symptoms (nausea in about 10% of persons receiving a 50 R dose) for persons who previously have received only very small doses. Therefore, one of the cave occupants makes a rapid radiation survey for about 1-1/2 miles along the proposed route, stopping to charge and read a KFM about **every** quarter of a mile. He finds no dose rates much higher than 20 R/hr.

Pg 12--(38)

So, the cave occupants decide the risk is small enough to justify some of them leaving shelter for about 2-1/2 hours to get water.

D. Estimating the **Dangers** from Different Radiation Doses

Fortunately, the human body -- if given enough time -- can repair most of the damage caused by radiation. An historic example: A healthy man accidentally received a daily **dose** of 9.3 R (or somewhat more) of fallout-type radiation each day for a period of 106 days. His total accumulated **dose** was at least 1000 R. A dose of one thousand roentgens, if received in a few days, is almost three times the dose **likely** to kill the average man if he receives the whole dose in a few days and after a nuclear attack cannot get medical treatment, adequate rest, etc. However, the only symptom this man noted was serious fatigue.

The occupants of a high-protection-factor shelter (such as a trench shelter covered with 2 or 3 feet of earth and having **crawlway** entrances) would receive less than 1/200 of the radiation dose they would receive outside. Even in most areas of very heavy fallout, persons who remain **continuously** in such a shelter would receive a total accumulated **dose** of less than 25 R in the first day after the attack, and less than 100 R in the first two weeks. At the end of the first two weeks, such shelter occupants could start working outside for an increasing length of time each day, receiving a **daily dose** of no more than 6 R for up to two months without being sickened.



To control radiation exposure in this way, each shelter must have a fallout meter, and a daily record must be kept of the approximate total dose received each day by every shelter occupant, both while inside and outside the shelter. The long-term penalty which would result from a dose of 100 R received within a few weeks is much less than many Americans fear. If 100 average persons received an external dose of 100 R during and shortly after a nuclear attack, the studies of the Japanese A-bomb survivors indicate that no more than one of them is likely to die during the following 30 years as a result of this 100 R radiation dose. These delayed radiation deaths would be due to leukemia and other cancers. In the desperate crisis period following a major nuclear attack, such a relatively small shortening of life expectancy during the following 30 years should not keep people from starting recovery work to save themselves and their fellow citizens from death due to lack of food and other essentials.

A healthy person who previously has received a total accumulated dose of no more than 100 R distributed over a 2-week period should realize that:

100 R, even if all received in a day or less, is unlikely to require medical care--provided during the next 2 weeks a total additional dose of no more than a few R & received. Pg 12--(39)

350 R received in a few days or less is likely to prove fatal after a large nuclear attack when few survivors could get medical care, sanitary surroundings, a well-balanced diet, or adequate rest.

600 R received in a few days or less is almost certain to cause death within a few days.

E. Using a KFM to Reduce the Doses Received Inside a Shelter

Inside most shelters, the dose received by an occupant varies considerably, depending on the occupant's location. For example, inside an expedient covered-trench shelter the dose rate is higher near the entrance than in the middle of the trench. In a typical basement shelter the best protection is found in one corner. Especially during the first several hours after the arrival of fallout, when the dose rates and doses received are highest, shelter occupants should use their fallout meters to determine where to place themselves to minimize the doses they receive. They should use available tools and materials to reduce the doses they receive, especially during the first day, by digging deeper (if practical) and reducing the size of openings by partially blocking them with earth, water containers, etc. -- while maintaining adequate ventilation. To greatly reduce the danger from fallout particles entering the body through nose or mouth, shelter occupants should at least cover their nose and mouth with a towel or other cloth while the fallout is being deposited outside their shelter.

The air inside an occupied shelter often becomes very humid. If a good flow of outdoor air is flowing into a shelter -- especially if pumped by briefly operating a KAP or other ventilating pump -- a KFM usually can be charged at the air intake of the shelter room without putting it inside a dry-bucket. However, if the air to which a KFM is exposed has a relative humidity of 90% or higher, the instrument cannot be charged, even by quickly unrolling a roll of tape. Pg 12--(40)

In extensive areas of heavy fallout, the occupants of most home basements, that provide inadequate shielding against heavy fallout radiation, would be in deadly danger. By using a dependable fallout meter, occupants would find that persons lying on the floor in certain locations would receive the smallest doses, and that, if they improvise additional shielding in these locations, the doses received could be greatly reduced. Additional shielding can be provided by placing a double layer of doors, positioned about two feet above the floor and strongly supported near their ends, and by putting books, containers full of water and other heavy objects on top of these doors. Or, if tools are available, breaking through the basement floor and digging a shelter trench will greatly increase available protection against radiation. If a second expedient ventilating pump, a KAP, is made and used as a fan, such an extremely cramped shelter-inside a shelter usually can be occupied by several times as many persons.

END OF INSTRUCTIONS



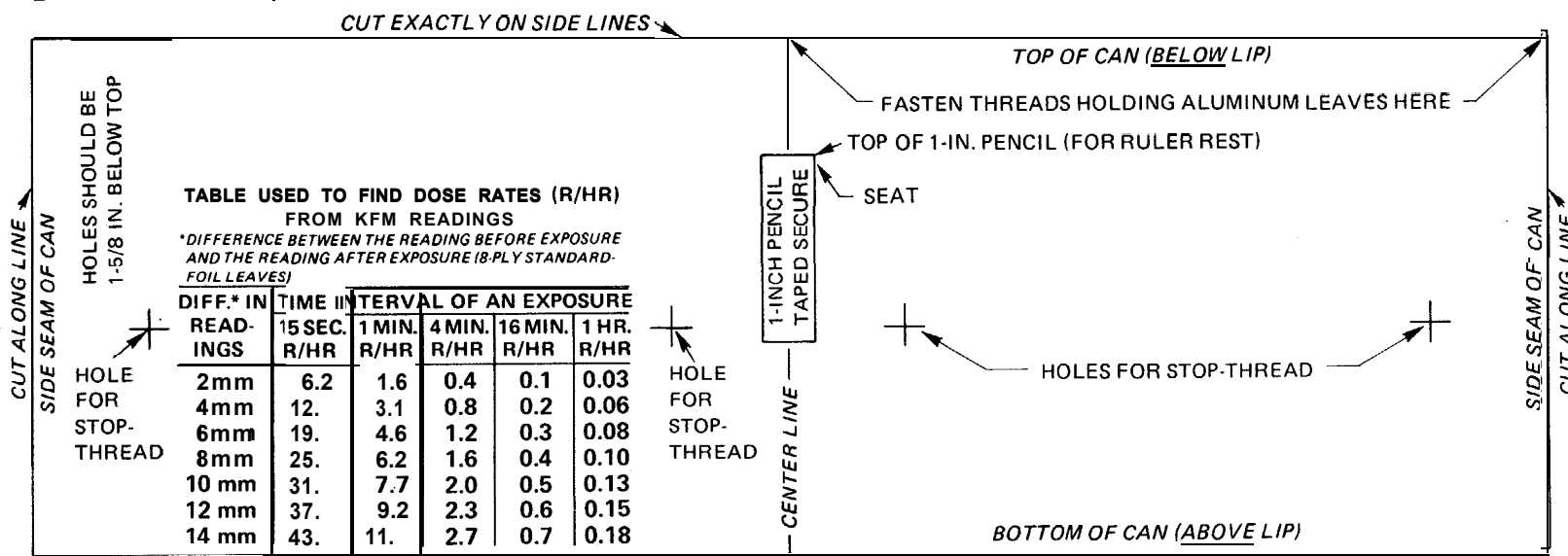
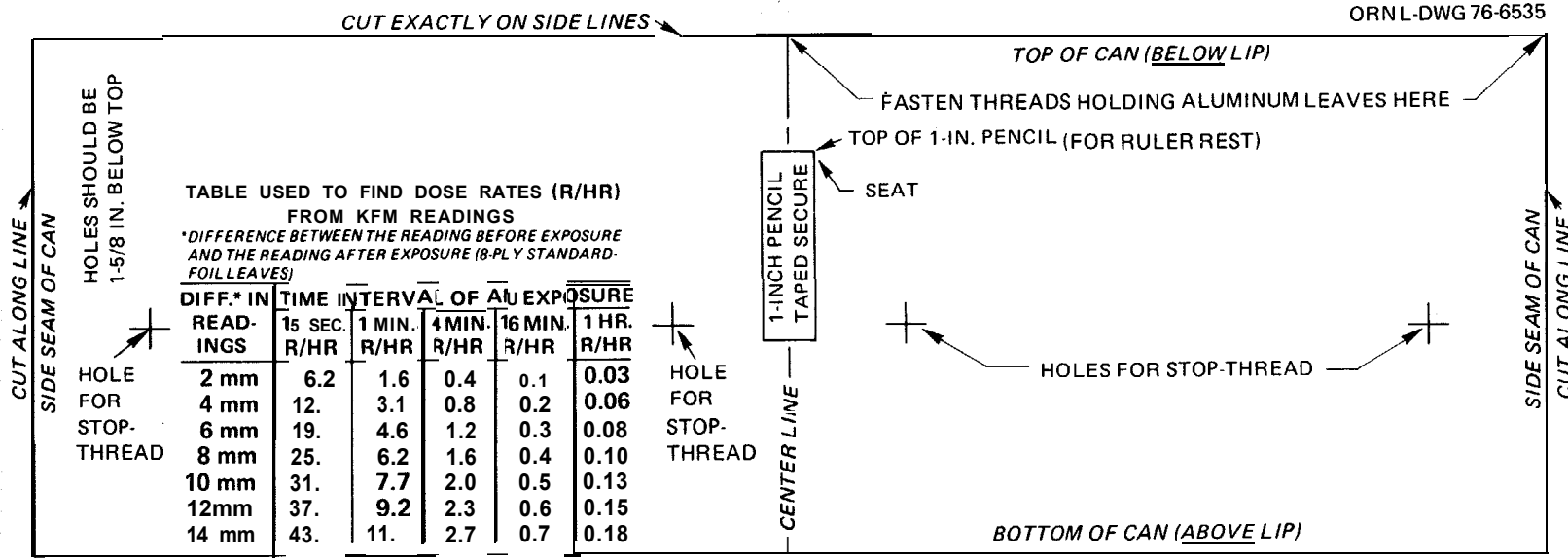

PAPER PATTERN TO WRAP AROUND KFM CAN (GLUE OR TAPE SECURELY TO CAN)

CUT OUT THESE PATTERNS, EACH OF WHICH IS THE EXACT SIZE FOR A KFM.

CAUTION: XEROX COPIES OF THESE PATTERNS WILL BE TOO LARGE.

PATTERN PAGE (A)

INSTRUCTIONS
 EXTRA PAGE



PATTERN FOR CLEAR-PLASTIC COVER FOR KFM CAN

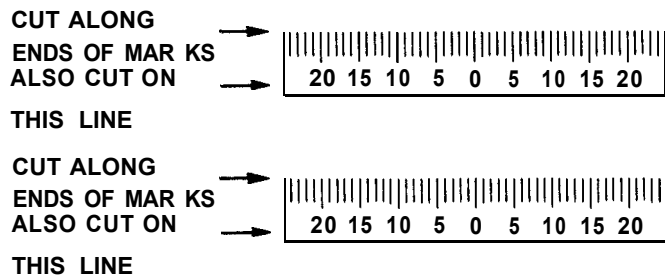
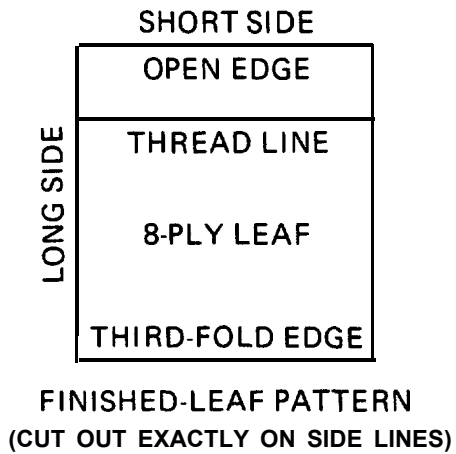
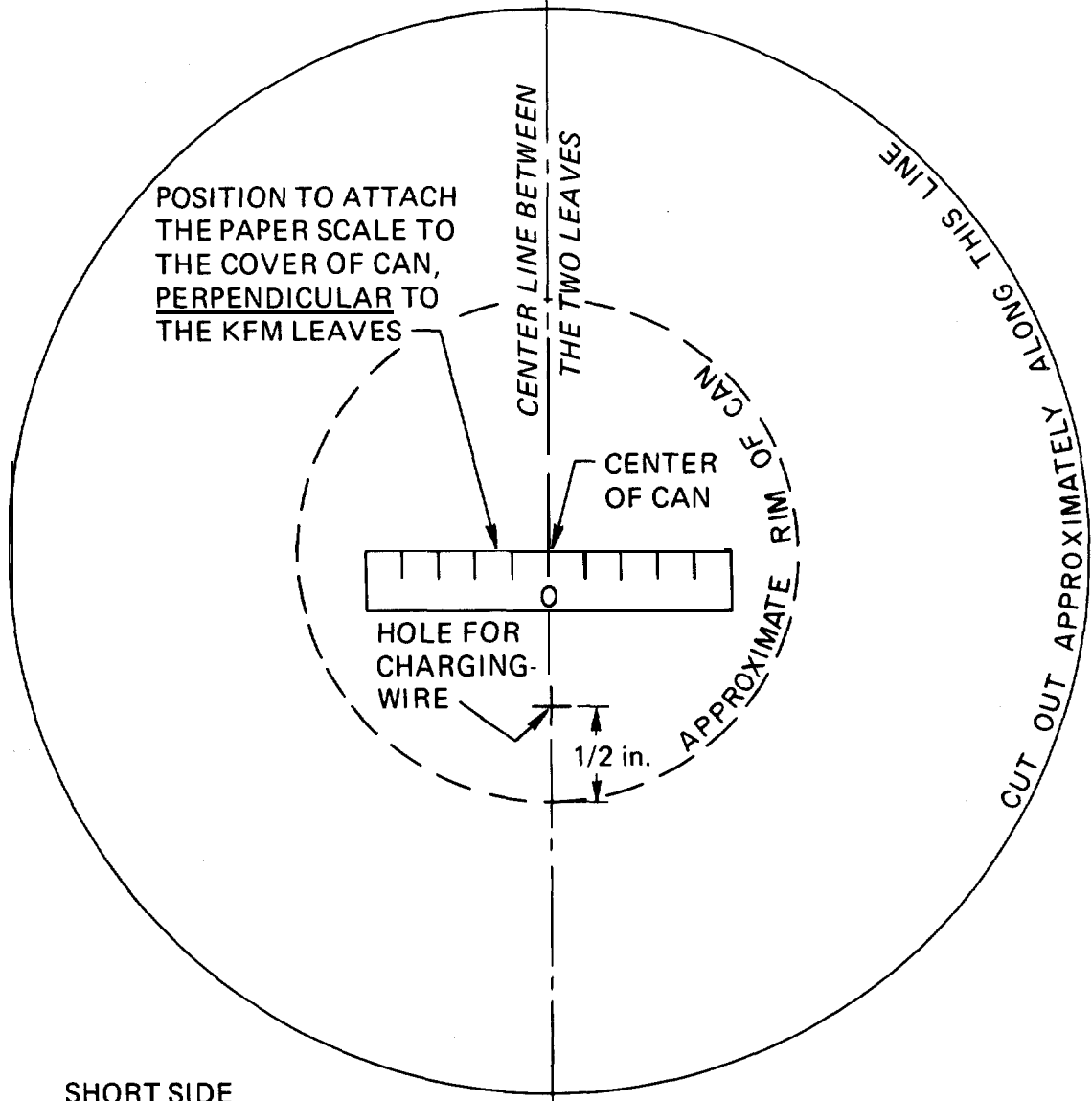

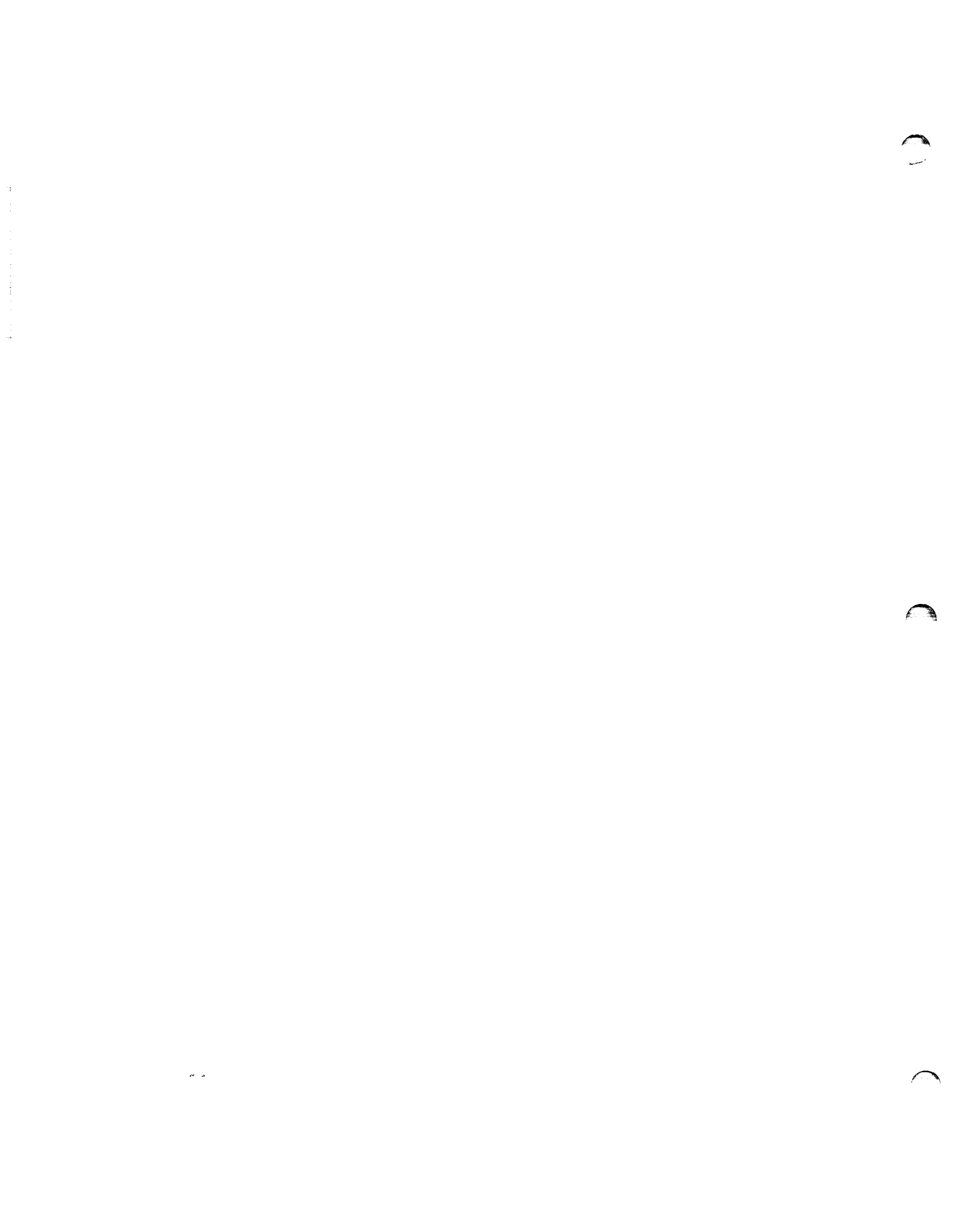

COVER THE TWO "TAPE HERE" RECTANGLES WITH SAME-SIZED PIECES OF TAPE, TO KEEP FROM TEARING THE PAPER WHEN REMOVING OTHER PIECES OF TAPE. THEN, USING TWO OTHER PIECES OF TAPE THIS SAME SIZE, TAPE THE THREAD ONTO THIS GUIDE SHEET, AND LATER ATTACH A LEAF TO THE TAPED DOWN THREAD.

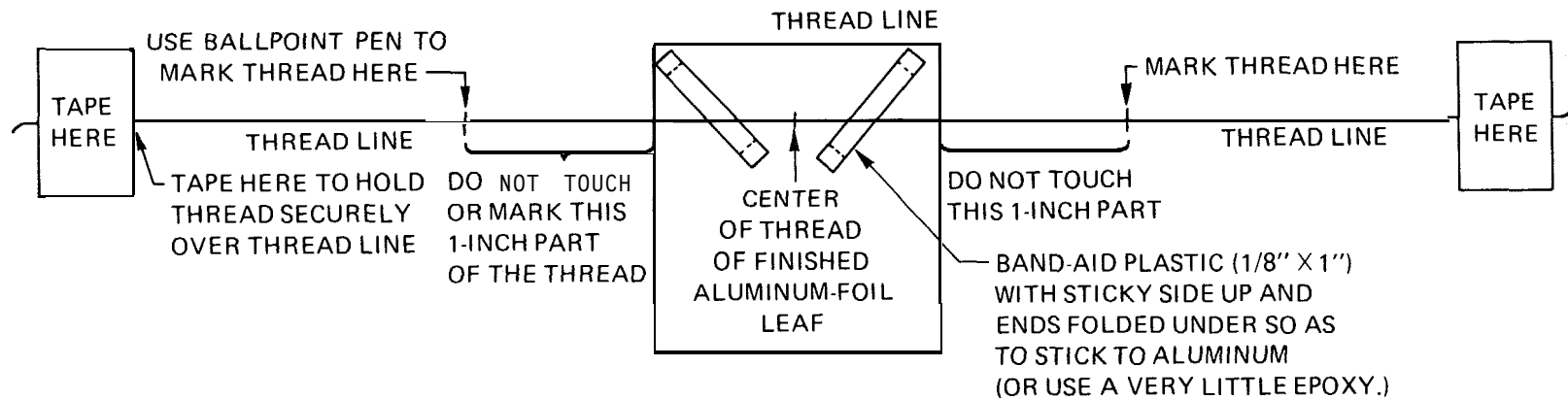

WARNING: The parts of the thread that will be inside the can and on which the leaf will be suspended must serve to insulate the high-voltage electrical charges to be placed on the leaf. Therefore, the suspended parts of the thread must be kept very clean.



INSTRUCTIONS
EXTRA PAGE

REMINDEES FOR OPERATORS	REMINDEES FOR OPERATORS
<p>THE DRYING AGENT INSIDE A KFM IS O.K. IF, WHEN THE CHARGED KFM IS NOT EXPOSED TO RADIATION, ITS READINGS DECREASE BY 1 MM OR LESS IN 3 HOURS.</p> <p>READING: WITH THE READING EYE 12 INCHES VERTICALLY ABOVE THE SEAT, NOTE ON THE MM SCALE THE SEPARATION OF THE LOWER EDGES OF THE LEAVES. IF THE RIGHT LEAF IS AT 10 MM AND THE LEFT LEAF IS AT 7 MM, THE KFM READS 17 MM. NEVER TAKE A READING WHILE A LEAF IS TOUCHING A STOP-THREAD. NEVER USE A KFM READING THAT IS LESS THAN 5MM.</p> <p>FINDING A DOSE RATE: IF BEFORE EXPOSURE A KFM READS 17 MM AND IF AFTER A 1-MINUTE EXPOSURE IT READS 5 MM, THE DIFFERENCE IN READINGS IS 12 MM, THE ATTACHED TABLE SHOWS THE DOSE RATE WAS 9.6 R/HR DURING THE EXPOSURE.</p> <p>FINDING A DOSE: IF A PERSON WORKS OUTSIDE FOR 3 HOURS WHERE THE DOSE RATE IS 2 R/HR, WHAT IS HIS RADIATION DOSE? ANSWER: 3 HR x 2 R/HR = 6 R.</p>	<p>FINDING HOW LONG IT TAKES TO GET A CERTAIN R DOSE: IF THE DOSE RATE IS 1.6 R/HR OUTSIDE AND A PERSON IS WILLING TO TAKE A 6 R DOSE, HOW LONG CAN HE REMAIN OUTSIDE? ANSWER:</p> $6 R \div 1.6 R/HR = 3.75 HR = 3 \text{ HOURS AND } 45 \text{ MINUTES.}$ <p>FALLOUT RADIATION GUIDES FOR A HEALTHY PERSON NOT PREVIOUSLY EXPOSED TO A TOTAL RADIATION DOSE OF MORE THAN 100 R DURING A P-WEEK PERIOD:</p> <p>6 R PER DAY CAN BE TOLERATED FOR UP TO TWO MONTHS WITHOUT LOSING THE ABILITY TO WORK.</p> <p>100 R IN A WEEK OR LESS IS NOT LIKELY TO SERIOUSLY SICKEN.</p> <p>350 R IN A FEW DAYS IS LIKELY TO PROVE FATAL UNDER POST-ATTACK CONDITIONS,</p> <p>600 R IN A WEEK OR LESS IS ALMOST CERTAIN TO CAUSE DEATH WITHIN A FEW WEEKS.</p>
<p>THE DRYING AGENT INSIDE A KFM IS O.K. IF, WHEN THE CHARGED KFM IS NOT EXPOSED TO RADIATION, ITS READINGS DECREASE BY 1 MM OR LESS IN 3 HOURS.</p> <p>READING: WITH THE READING EYE 12 INCHES VERTICALLY ABOVE THE SEAT, NOTE ON THE MM SCALE THE SEPARATION OF THE LOWER EDGES OF THE LEAVES. IF THE RIGHT LEAF IS AT 10 MM AND THE LEFT LEAF IS AT 7 MM, THE KFM READS 17 MM. NEVER TAKE A READING WHILE A LEAF IS TOUCHING A STOP-THREAD. NEVER USE A KFM READING THAT IS LESS THAN 5MM.</p> <p>FINDING A DOSE RATE: IF BEFORE EXPOSURE A KFM READS 17 MM AND IF AFTER A 1-MINUTE EXPOSURE IT READS 5 MM, THE DIFFERENCE IN READINGS IS 12 MM, THE ATTACHED TABLE SHOWS THE DOSE RATE WAS 9.6 R/HR DURING THE EXPOSURE.</p> <p>FINDING A DOSE: IF A PERSON WORKS OUTSIDE FOR 3 HOURS WHERE THE DOSE RATE IS 2 R/HR, WHAT IS HIS RADIATION DOSE? ANSWER: 3 HR x 2 R/HR = 6 R.</p>	<p>FINDING HOW LONG IT TAKES TO GET A CERTAIN R DOSE: IF THE DOSE RATE IS 1.6 R/HR OUTSIDE AND A PERSON IS WILLING TO TAKE A 6 R DOSE, HOW LONG CAN HE REMAIN OUTSIDE? ANSWER:</p> $6 R \div 1.6 R/HR = 3.75 HR = 3 \text{ HOURS AND } 45 \text{ MINUTES.}$ <p>FALLOUT RADIATION GUIDES FOR A HEALTHY PERSON NOT PREVIOUSLY EXPOSED TO A TOTAL RADIATION DOSE OF MORE THAN 100 R DURING A 2-WEEK PERIOD:</p> <p>6 R PER DAY CAN BE TOLERATED FOR UP TO TWO MONTHS WITHOUT LOSING THE ABILITY TO WORK.</p> <p>100 R IN A WEEK OR LESS IS NOT LIKELY TO SERIOUSLY SICKEN.</p> <p>350 R IN A FEW DAYS IS LIKELY TO PROVE FATAL UNDER POST-ATTACK CONDITIONS,</p> <p>600 R IN A WEEK OR LESS IS ALMOST CERTAIN TO CAUSE DEATH WITHIN A FEW WEEKS.</p>



6. ACCURACY AND RANGE OF THE KFM

Essential characteristics of the KFM include its capability to hold an unusually large charge for an electroscopes and its capability to enable gamma doses to discharge the charge on its insulated aluminum-foil leaves in such a way that the changes in the observed separations of the lower edges of its leaves, caused by the gamma doses, are directly proportional to the magnitude of these doses. These characteristics are described in more detail in Appendix A, "Design Principles and Procedures Used in Developing the KFM."

The schematic drawing of a KFM (see Fig. 6.1, below) shows the forces operating on the charged leaves of a KFM. By optimizing the size,

ORNL-DWG 75-11589R

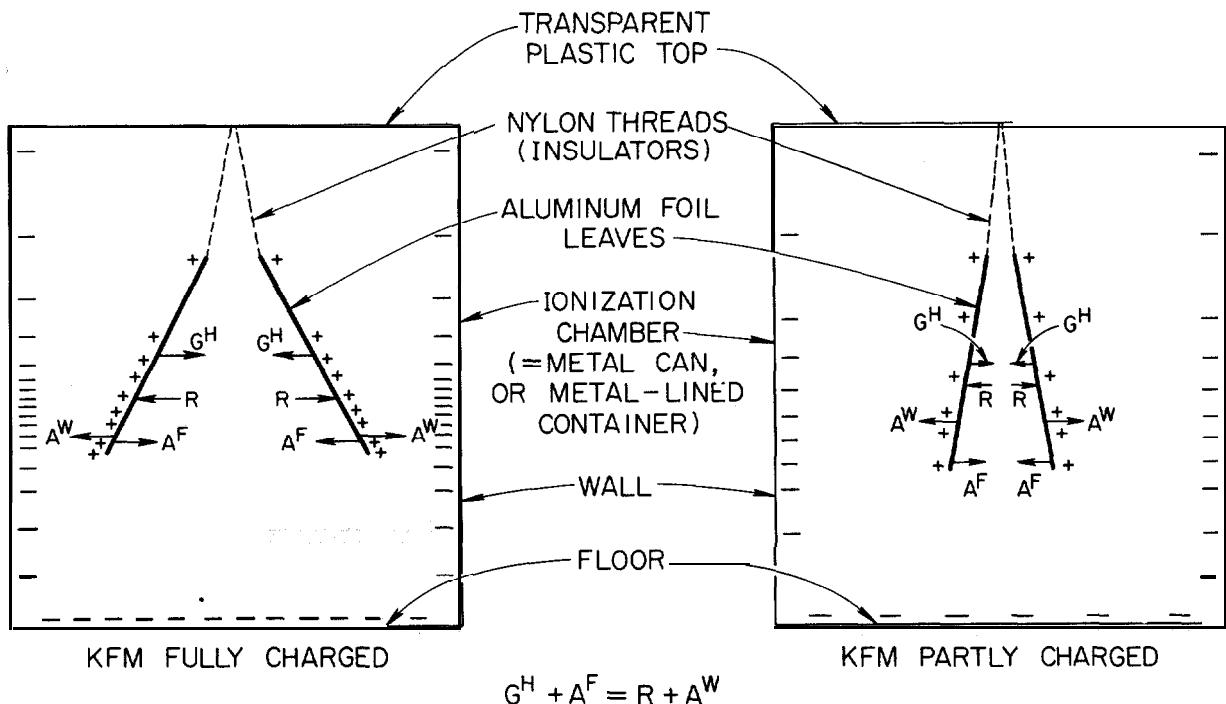

Fig. 6.1. Schematic Drawing Showing Balanced Forces Operating on the Charged Leaves of a KFM. Forcing the leaves together are G^H , the horizontal component of the gravitational forces on each leaf, and A^F , the net horizontal component of the forces of attraction between the unlike charges on each leaf and on the floor of the ionization chamber. Forcing the leaves apart are R , the horizontal component of the like charges on the leaves, and A^W , the horizontal component of the forces of attraction between the unlike charges on each leaf and on the wall of the ionization chamber.

shape, weight, and suspension system of the leaves relative to the size and shape of the ionization chamber, the desired essential characteristics of the KFM were attained.

For an electroscope-type fallout meter to be practical, accurate measurements must be obtainable without charging the instrument to any specified initial reading. Figure 6.2, below, shows the essentially straight-line relationships between successive readings of two KFMs with 8-ply leaves of standard aluminum foil and the gamma doses that caused the changes in these readings. Figure 6.2 also shows that the accuracy of a KFM is not dose-rate-dependent for dose rates ranging from 2.0 R/hr up to 10.0 R/hr. Calibration tests at much lower dose rates and at dose rates of up to 20 R/hr have indicated this essential characteristic prevails throughout a KFM's practical range of measurements.

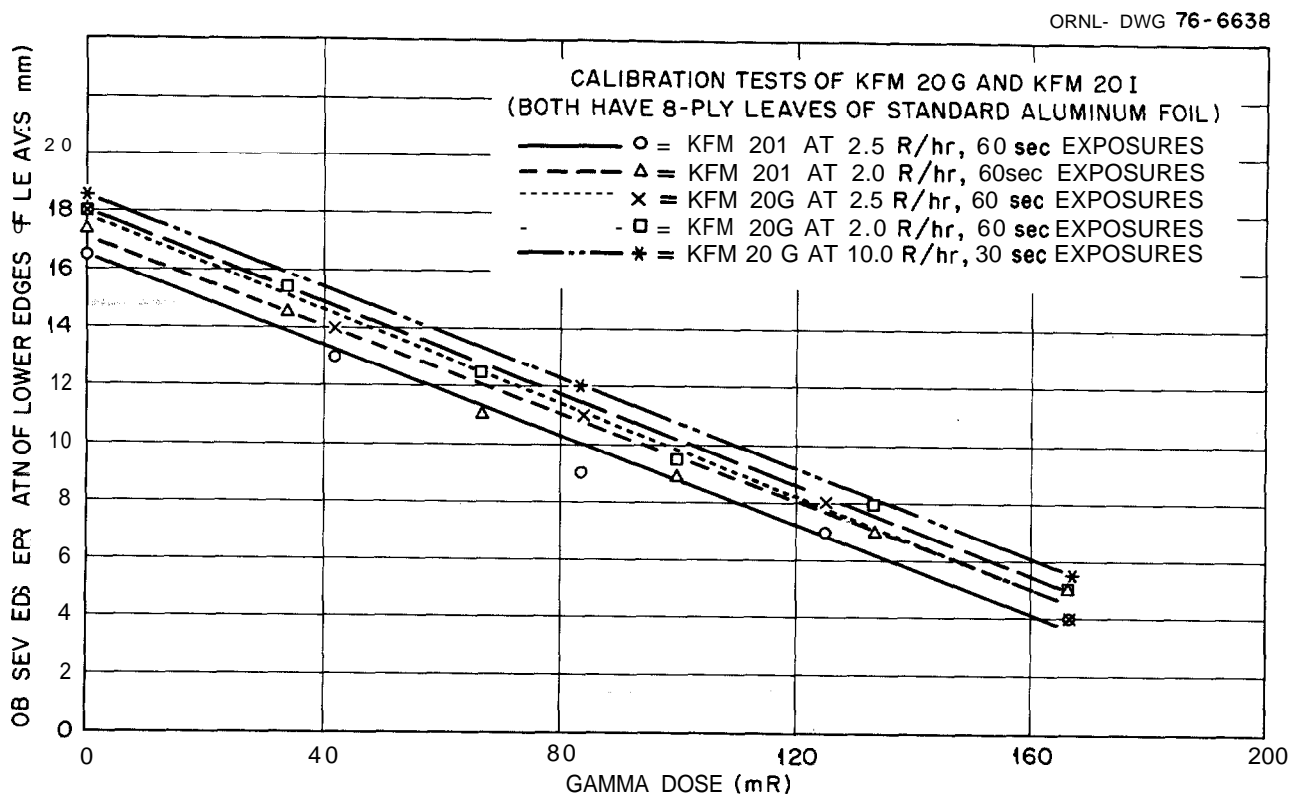

Fig. 6.2. Calibration Curves for Two KFMs with 8-Ply Leaves.

The accuracy of the **KFM** is shown more clearly by Fig. 6.3, below, in which the calibration points for the same calibration tests covered by Fig. 6.2 have been normalized. For a RPM with 8-ply leaves, an essentially straight-line relationship between changes in readings and the causative gamma doses is seen to prevail throughout a dose range of about 180 **mR**. Assuming the practical minimum time interval of exposure to war fallout radiation is 15 **sec**, a 180 **mR** dose range makes practical the measurement of dose rates of up to 43 **R/hr**. (15 **sec** = 1/240 hr; 0.18 R/1/240 hr = 0.18 R x 240/hr = 43 R/hr.)

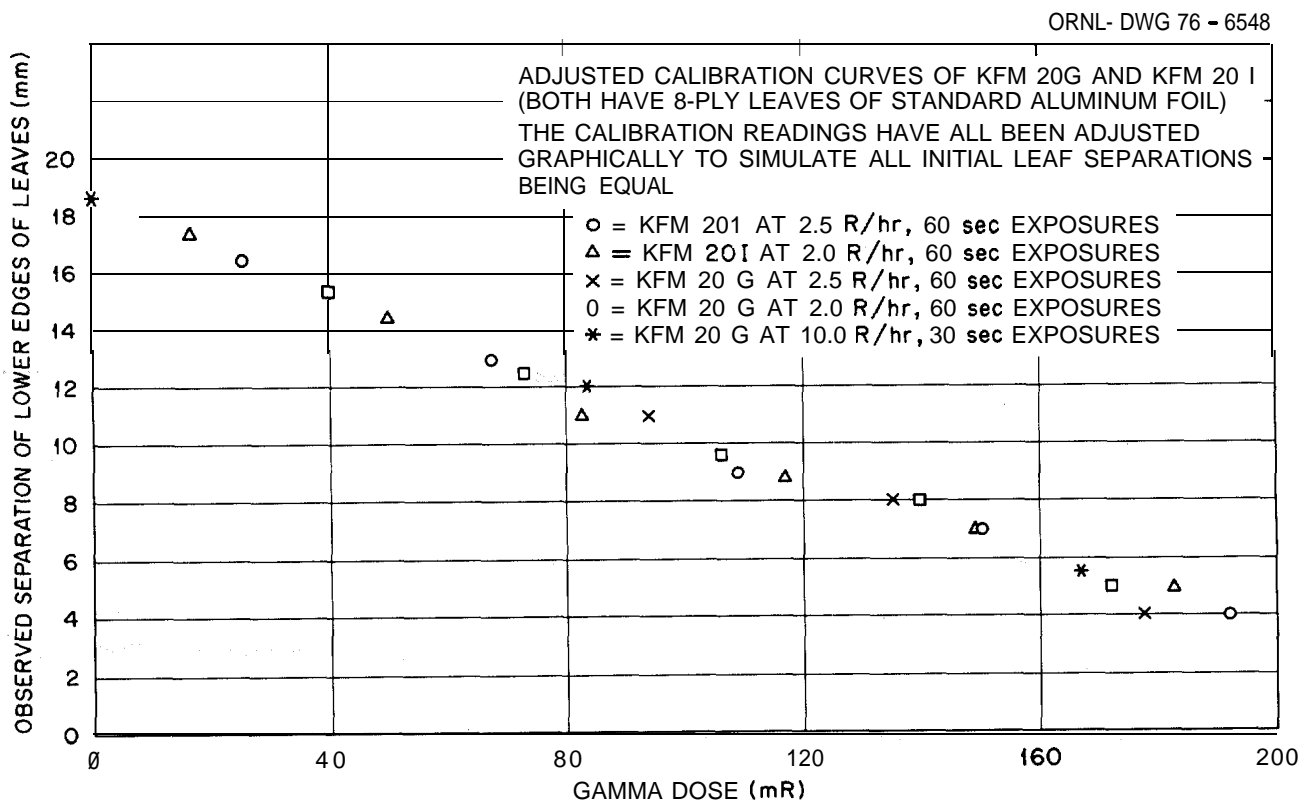

Fig. 6.3. Normalized Calibration Points for Two **KFM**s, Derived Graphically from Fig. 6.2.

Figure 6.3 shows that the accuracy of both **KFM 20 I** and **KFM 20 G** is better than $\pm 25\%$. Although most of the calibration tests of **KFM**s built by high school students and test families demonstrated comparable accuracy, possible variations in materials and workmanship have caused the authors to claim an accuracy of only about $\pm 25\%$ for the **KFM**.

Appendix B, "Additional Technical Information," gives more facts concerning the accuracy of **KFMs**, together with information useful to designers on the characteristics and materials of this instrument.

7. CONCLUSIONS AND RECOMMENDATIONS

1. The **KFM** meets all the requirements for a homemade fallout meter. No other homemade fallout meter which meets these requirements has yet been designed.

2. Most Americans do not have and would be unable to obtain a fallout meter if on short notice the United States were threatened by or subjected to a nuclear attack.

3. Having reliable fallout meters and being able to use them would increase most Americans' chances of surviving a nuclear attack. Therefore, at least camera-ready copy of the field-tested instructions for making and using a **KFM** given in this report should be prepared and kept ready for rapid distribution to local newspapers. If a crisis threatening nuclear war develops, newspapers could print the instructions and distribute them to many millions of Americans.

4. Visual-oral demonstrations are the best means for expediting the mastery of new skills, especially in as generally mysterious and worrisome a field as fallout radiation. Therefore, at least one short TV film on the **KFM** should be produced and kept ready for release, to shorten the time required for untrained citizens to follow **written** instructions for making and using this instrument.

5. To enable persons interested in defense preparations and/or science to build, use, and possibly further improve the **KFM**, the instructions, with supportive technical information, should be made available in the near future to local civil defense directors, science teachers, and Boy Scouts.

APPENDIX A

DESIGN PRINCIPLES AND PROCEDURES
USED IN DEVELOPING THE KFM

In designing the KFM, one of the essential objectives was to produce an instrument that would hold the largest practical charge relative to the size of the ionization chamber, in order that a comparatively large gamma dose would be required to discharge the electroscope-capacitor. Results of initial experiments with large ionization chambers indicated the importance of reducing the size of an electroscope-capacitor designed for use as a fallout meter. The smaller the volume of air (in the ionization chamber of the electroscope-capacitor) per unit of surface area of the leaves, the larger is the dose of ionizing radiation required to discharge its leaves.

The charge that can be placed on the leaves of a given type of electroscope (when the leaves are in a given position) is approximately proportional to the area of the leaves. If all linear dimensions of the electroscope are halved, then the area of the leaves is reduced to one-fourth, whereas the volume of the ionization chamber is reduced to one-eighth of the original. Thus in the smaller instrument there is twice the area of leaves ($1/4$ divided by $1/8$ equals 2) per unit volume of air in the ionization chamber, and the range of the smaller instrument is approximately doubled due to this effect alone. The capacitance is also increased, but not in proportion to the increase in relative area of the leaves, because of the reductions in the distances for spark discharges and other types of leakage from the leaves to the walls, at reduced potentials on the leaves.

Obviously, it is an oversimplification to consider each of the two aluminum leaves of a KFM to be one plate of a parallel-plate capacitor and to consider the nearer wall of the ionization chamber (the metal can of a KFM) to be the other plate, with the dry air between a leaf and the nearest part of the wall of the can being the separating dielectric. However, this concept is helpful, because it can then be assumed that equations for a parallel-plate capacitor can be used to predict both the

charge that a KFM can hold and its range of measurements. One of these useful equations is:

$$Q = k \frac{VA}{d} ,$$

where

Q = quantity of charge for unit rise in potential,

V = potential difference between a leaf and the wall of the metal ionization chamber (which is at ground potential),

A = the area of each leaf,

d = distance between a leaf and the nearest parts of the wall of the can, and

k = a constant.

With these assumptions, to maximize "Q" it is necessary to make "V" and "A" as large as practical, and to make "d" as small as practical.

"V" can be made larger -- provided a charging device capable of producing a higher potential is available -- by increasing the weight of the leaves of a KFM and by making the angles smaller between the leaf-supporting threads and the horizontal. By these means, a larger potential (relative to the grounded metal ionization chamber) can be placed on the leaves before the forces of repulsion acting between the two like-charged leaves, plus the forces of attraction between the opposite charges on each leaf and on the nearer wall of the can, cause each of the two leaves to move "as near as practical" to its adjacent wall. "As near as practical" means a distance slightly greater than the distance at which spark-discharging will begin to occur from a leaf to the metal wall of the ionization chamber. Neither of the leaves, when fully charged, should touch a stop-thread when the KFM is resting on a horizontal surface. (The insulating stop-threads are positioned so as to prevent the leaves from getting too near the walls when the KFM is being carried, jarred, or tilted.)

Leaves made of 8 plies of standard household aluminum foil are the most practical weight of leaves tested to date for a homemade KFM. Leaves of 1, 2, 4, and 6 plies are separated too far by the high-voltage

charges produced by the expedient electrostatic charging devices, resulting in loss of charge by spark discharges from the leaves to the walls. Leaves of 16 plies are not separated sufficiently by the available potentials to permit as accurate readings as can be made with 8-ply leaves.

"A" can be made larger by simply making each leaf as large as practical, while maintaining sufficient distances between the leaves and the walls of the ionization chamber to prevent the charge on the leaves from being discharged by leakage through the dry air to the grounded wall of the ionization chamber.

"d" can be made as small as practical by optimizing the dimensions of the leaves and their suspending threads for a given KFM, as indicated above.

When designing a practical fallout meter that has very large leaves compared to the size of its ionization chamber, it is essential to provide means for preventing the leaves from accidentally touching or getting too close to the walls of the ionization chamber, and thus being discharged. The most practical of the several means tested to date is incorporated in the KFM. In this instrument each of its two leaves is suspended on inclined, nonparallel threads so as to prevent the leaves from getting too close to the walls of the can in the directions of the planes of the leaves, when the KFM is moved or tilted. The two insulating stop-threads prevent the leaves from swinging (approximately perpendicularly to their planes) close enough to the walls to be discharged.

The height of the ionization chamber (the can) is determined by the provision of the minimum practical distance that will prevent discharge through the dry air between the bottom edges of the leaves and the tops of the lumps or particles of desiccant placed on the floor of the ionization chamber.

The practical minimum size of a homemade KFM appears to be about that of the KFM described in this report. The ionization chamber of this size KFM is a standard 8-oz can. Or a common 10½- to 12-oz soup can, a pop can, or a beer can of the same diameter, with its height cut

down to that of a standard 8-oz can, will serve. Making a KFM smaller than this model requires considerably greater manual dexterity and necessitates finding a can with a much less common diameter. Furthermore, if the distances between the leaves and the walls of the can are made smaller than those in this model KFM, then the voltage that can be held on the leaves is reduced. Smaller dimensions result in shorter "spark gaps" that permit discharges from the leaves to the walls, thereby reducing the potential that can be held on the leaves. The practical gamma-measuring ranges of KFMs tested to date that have smaller ionization chambers than the KFM described in this report are not significantly larger than the range of this KFM with 8-ply leaves of standard aluminum foil.

A KFM, unlike most electroscopes, is read by noting on a horizontal scale the apparent separations of the lower edges of its leaves, while looking down from a point vertically above the leaves and at the specified distance. To be a practical instrument for measuring fallout radiation, increments of radiation dose should result in directly proportional reductions in the apparent separations of the lower edges of the leaves, as noted on the scale of the instrument. In a KFM, the linearity between dose and the resultant reduction in the apparent separation of the leaves is sensitive to the center of gravity of the leaves and to their method of suspension. A number of experiments have tested other models of KFMs, ones with leaves having other centers of gravity and/or other designs of their leaf-suspending threads. These other models have not given as accurate radiation measurements throughout the practical range of the separations of their leaves.

The adjustable charging-wire of a KFM is the best means found to date for transferring a high-potential charge from an electrostatic charging device to the leaves of an electroscope used as a fallout meter, and subsequently for preventing the discharge of the leaves to the air outside the ionization chamber -- especially if the outside air is humid. By promptly making the spark gap much greater between the leaves and the lower end of the charging-wire, discharge from the leaves through the very dry air of the ionization chamber is made negligible.

Since the design of a KFM involves such a large number of inter-related variables, further practical experimentation should result in more advantageous dimensions than those embodied in this model KFM. This model was developed by making and testing only a few dozen variants of electrostatic fallout meters of several designs.



APPENDIX B

ADDITIONAL TECHNICAL INFORMATION

B.1 KFM Ionization Chambers

B.1.1 Relationship of the Size of the Ionization Chamber to a KFM's Range of Measurements

The relative size of the ionization chambers of KFMs and of similar electroscopes-capacitors is the most important factor affecting the sensitivity of such instruments. For example, an instrument that was identical to the KFM described in this report, except that it had 4-ply leaves and had an equal-diameter ionization chamber (can) twice as tall, was found to require only 5.4 mR dose to cause a 1-mm difference in the readings taken before and after exposure. A KFM with identical 4-ply leaves and a standard 8-oz can for its ionization chamber (thus having half the volume) was found to require a 10.0-mR dose to cause 1 mm difference in readings.

B.1.2 Linings of the Ionization Chamber (the Can)

All types of metal cans having the specified dimensions -- those of a standard 8-oz (227 g) can -- that have been used to make the ionization chambers of calibrated KFMs have proved satisfactory. Neither the kind of metal nor its coating significantly affects the accuracy of the KFM. For example, calibration tests involved four KFMs, each having different types of 8-oz cans used by different food-canning companies and having "identical" 4-ply leaves of standard household aluminum foil:

- 20 A - with a yellowish, varnish-like original inner coating, modified with an epoxied-in lining of 3-mil Mylar film,
- 20 B - with a yellowish, varnish-like original inner coating (same as 20 A, but without any added lining),
- 20 c - with no inner coating (its tin-plate interior had a crystalline appearance), and
- 20 D - with an opaque white, plastic-like original inner coating.

The results of these calibration tests are graphed in Fig. B.1 below. Note that if these curves were each made to begin with a pre-exposure reading of 21 mm, these normalized curves for the three KFMs with unmodified ionization chambers (cans) would be essentially straight lines until the leaf separation is less than 5 mm. A 5-mm separation would result from a gamma dose of about 160 mR.

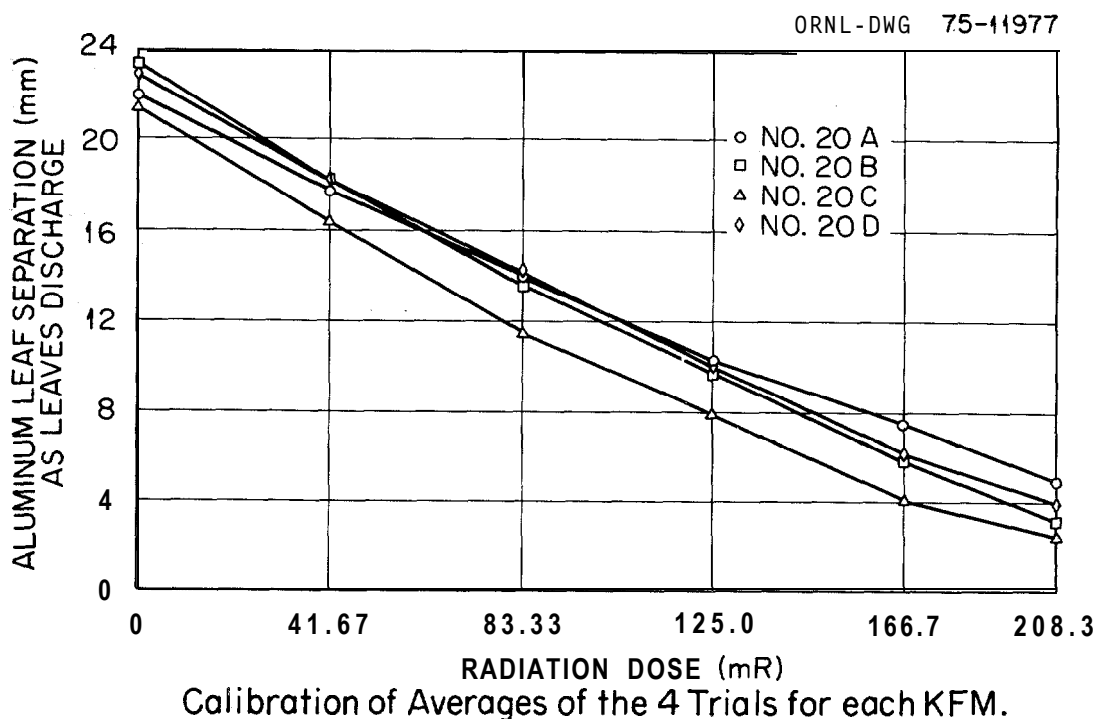

Fig. B.1. Calibration Curves for Three KFMs (20 B, 20 C, and 20 D) Made with 8-oz Cans Having Different Types of Original Inner Coatings, and for a Fourth KFM (20 A) Having an 8-oz Can Modified with an Epoxied-In Lining of 3-Mil Mylar Film.

B.2 Range and Accuracy of Measurements

The fact that for KFMs with 4-ply leaves the range of accurate readings is limited to a maximum dose of about 160 mR -- a dose that results in a difference in readings of about 16 mm -- is illustrated more clearly by the following two graphs, Figs. B.2 and B.3. If one assumes that the minimum time interval for a practical exposure of a

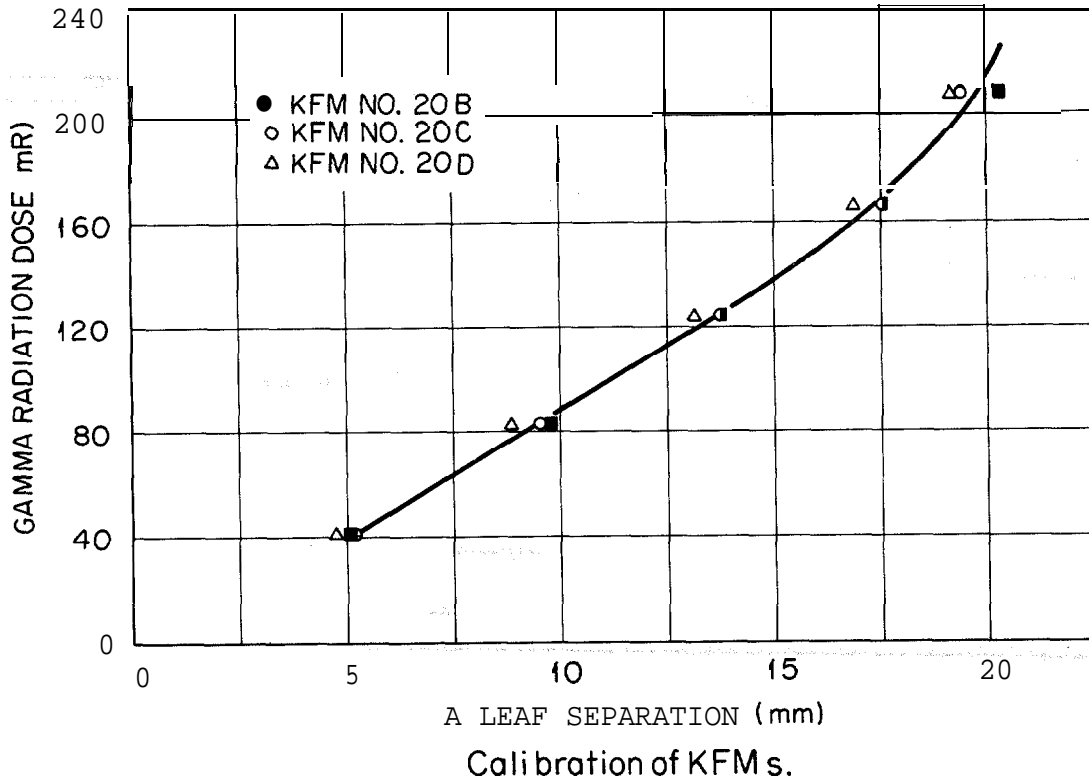

Fig. B.2. Data from the Calibration Curves for KFM s 20 B, 20 C, and 20 D (see Fig. B.1), Normalized and Graphed to Show the Changes in Leaf Separation Produced by Different Gamma Radiation Doses.

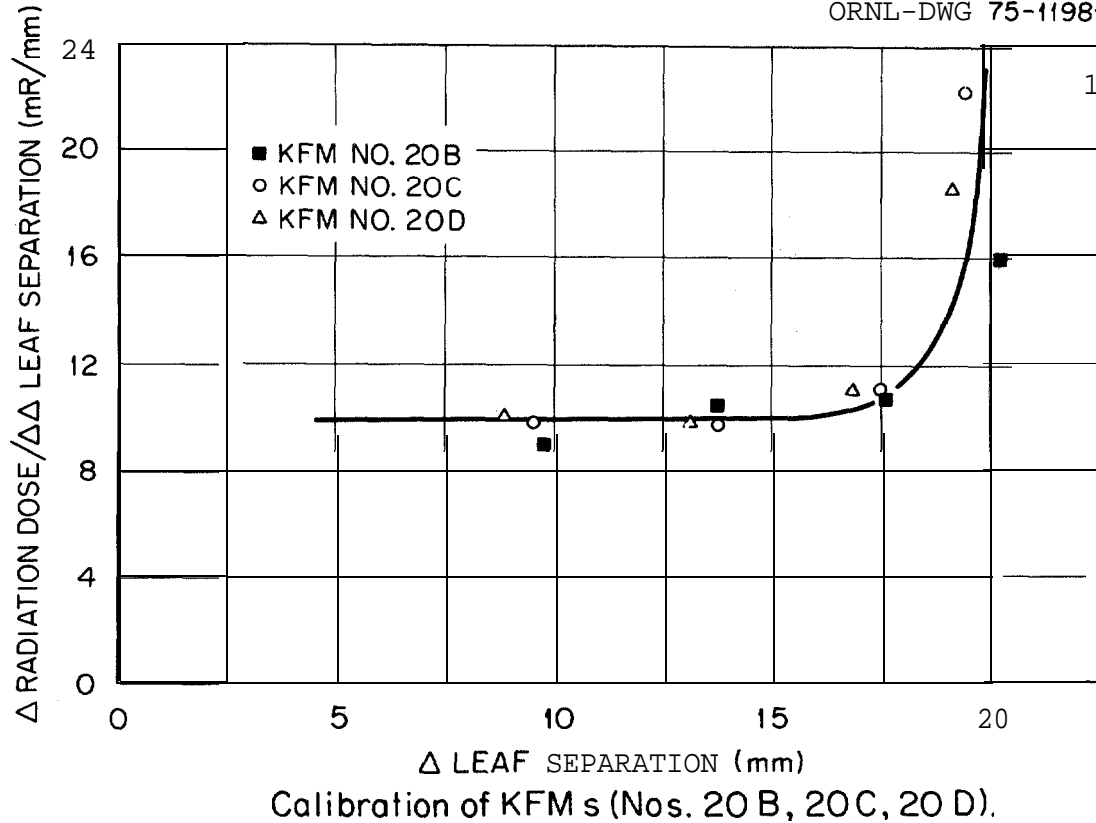

Fig. B.3. Data Derived from the Normalized Calibration Curves of KFM s 20 B, 20 C, and 20 D, Indicating the Range of Accurate Readings of KFM s with 4-Ply Leaves.

KFM to fallout radiation is 15 **sec**, then a maximum dose of 160 **mR** corresponds to the measurement of a maximum dose rate of about 38 **R/hr** with a KFM having 4-ply leaves.

The path of the calibration points (if normalized so as to give the same initial readings) for the three **KFMs** (20 B, 20 C, and 20 D) made with 4-ply leaves and using unmodified cans indicates that the accuracy of a **KFM's** midrange measurements is well within $\pm 25\%$. As shown in the main body of this report, the accuracy of a KFM with 8-ply leaves is fully as good.

B.3 Aluminum-Foil Leaves

Variations in the weights of equal-area KFM leaves, caused by the use of different brands of standard household aluminum foils to make leaves of the same size and having the same number of plies, do not significantly affect the ranges (sensitivities) of otherwise similar **KFMs**.

Calibration tests of five **KFMs** having the same dimensions as the model detailed in this report, but having 1-ply, 2-ply, 4-ply, 8-ply, and 16-ply leaves, showed that the gamma dose required to produce a 1-mm difference in the readings taken before and after exposure varies approximately as the square root of the weights of the leaves. (A mathematical analysis of the functioning of a simplified hypothetical KFM showed this same variation with the square root of the weights of otherwise identical leaves. This analysis, however, was not satisfactory in several respects and therefore is not included in this report.) The following table summarizes the averaged results of these calibration tests:

No. of Plies in Leaves	Relative Wt of Leaves	$\sqrt{\text{Wt of}}Leaves$	$\frac{\sqrt{\text{Wt of}}Leaves}{2.82}$	mR Dose to Produce 1 mm Diff. in Readings	mR Dose to Produce 1 mm Diff. in Readings Divided by 12.8 mR
1-ply	1	1	0.35	5.0	0.39
2-ply	2	1.42	0.50	6.4	0.50
4-ply	4	2	0.71	9.8	0.77
8-ply	8	2.82	1.0	12.8	1.0
16-ply	16	4	1.4	19.0	1.5

In the third column of figures, the square root of each of the weights of the leaves is divided by the square root of the relative weight of 8-ply leaves. For comparison, in the last column on the right, each mR dose required to produce a 1-mm difference in readings is divided by 12.8 mR, the dose required to produce a 1-mm difference in readings in the KFM with 8-ply leaves. Note the similar values in the last column on the right and in the column listing the square roots of the weights of the leaves divided by the square root of the relative weight of the 8-ply leaves.

The 4-ply leaves were not adopted because when fully charged they are separated so far apart that they often "stick" to the grounded stop-threads, producing unreliable readings. In contrast, the 16-ply leaves cannot be charged so as to produce an initial leaf separation greater than about 15 mm; this is not enough leaf separation to result in maximum radiation measurements significantly larger than can be more reliably attained with 8-ply leaves. A KFM with 8-ply leaves can give initial readings of up to 20 mm and can be read more accurately because each scale division measures a smaller dose or dose rate. (Readings after exposure that are less than 5 mm are unreliable and are not used with any KFM.)

KFMs with 8-ply leaves are more rugged than KFMs with 4-ply leaves and do not require care in charging to avoid "sticking" a leaf to a stop-thread as a result of overcharging.

American brands of standard aluminum foil differ little in their weight per unit area:

<u>Brand</u>	<u>Wt per 2 Sq Ft (Grams)</u>
Diamond	8.16
Home Pride	7.81
Hyde Park	8.31
Reynolds Wrap	8.27
Silv-o-line	8.33
Universal	8.30
Wonderfoil (A&P)	8.01

The average weight per 2 sq ft of these seven "standard" aluminum foils is 8.17 g; this is slightly less than the average weight of the most widely sold standard aluminum foils. The average weight of 2 sq ft of "heavy duty" aluminum foil is about 11.8 g.

The use in the KFM of two charged, conducting leaves (with each leaf being insulated by its suspending threads and holding a separate charge that cannot migrate to any other part of the instrument) results in an electroscope-capacitor that does not have to be in a vertical position in order to give accurate measurements of radiation doses and dose rates. Inclinations of up to 3 degrees in the bottom of a KFM do not appreciably affect the accuracy of readings or measurements. When a KFM is tilted, the tilting causes one of its leaves to move closer to the nearer part of the grounded wall of its ionization chamber (can). As a result, this leaf is attracted more strongly to that part of the wall. This effect, however, is largely balanced by an opposite effect on the other leaf, which is less strongly attracted to its now more distant nearby wall, because of the tilting of the instrument.

In contrast, other high-range electroscope-capacitors made by the authors, instruments that had a single leaf connected by a conductor to

its support, had their readings and accuracy seriously affected by slight tiltings. When such an instrument is tilted in the direction that causes its single leaf to swing outward, the leaf is moved by gravitational forces nearer to the wall of its ionization chamber. Then the increased forces attracting the charge on the leaf (due to the leaf being nearer to the wall) cause additional charge to migrate to the single leaf from other parts of the instrument. This migration compounds uncompensated inaccuracies. Tilting in the opposite direction likewise causes serious inaccuracies.

B.4 Insulating Threads

Nylon thread and nylon monofilament "invisible thread" are much better insulators when the air around them is humid than are other common fine threads, especially cotton. However, in the very dry air maintained inside a KFM by its drying agent, tests have shown that any common fine thread is satisfactory for suspending the leaves and making the stop-threads. The following tests, conducted to determine the leakage rates of **KFMs** made with different kinds of threads and exposed under normal conditions, are indicative:

Leakage Rates of **KFMs** with 8-Ply Leaves, but with Different Kinds of Fine Threads Used to Suspend Their Leaves and to Make Their Stop-Threads. Leakage Rates are Expressed as the Differences in Readings (mm) Taken 24 Hours Apart

Desiccant Inside The KFM	Nylon Monofilament "Invisible Thread"	Silk	Cotton	Cotton-Coated Polyester
Anhydrite	0.5	2.0	2.0	2.0
Silica Gel	0.5	1.0	4.5	3.5

Although very fine nylon monofilament "invisible thread" is the best thread tested to date for insulating the leaves of a KFM, it is not preferred. It is difficult to work with and hard to see when it is used

for the adjustment-threads of the charging-wire of a KFM. Fine twisted nylon thread (not monofilament) is the first choice. If carefully made with fine twisted nylon thread or extra-fine unwaxed nylon dental floss, a KFM with 8-ply leaves will be discharged by leakage alone at a rate of 1 to 2 mm per 24 hours.

A 1-mm decrease in readings of a KFM with 8-ply leaves is produced by a gamma dose of about 12.8 mR delivered in an hour or less. The average background radiation is about 170 mR/year, equivalent to about 0.5 mR in 24 hours. Therefore, this KFM is discharged by leakage alone, as compared to being discharged by average background radiation, in a ratio of about 13 to 0.5, or about 26 to 1. However, if the problem is to monitor nuclear war fallout in the territory of a nation that has suffered a large-scale nuclear attack, the leakage rate of a well-made KFM containing an efficient desiccant is of no practical importance.

B.5 Drying Agents

B.5.1 Anhydrite

Anhydrite (CaSO_4) depends for its very effective desiccant action on both absorption and adsorption. In a closed space containing dry air at 30°C , anhydrite maintains in the dry air residual water weighing only 0.005 mg per liter of the dry air* until it has been rehydrated with water weighing about 6X of its original weight.

The size of the pieces of anhydrite used inside a KFM does not seriously affect the efficiency of its desiccant action. When exposed to room air, 1 g of powdered homemade anhydrite (made from wallboard gypsum) increased in weight 10 mg in 8.5 min; 1 g of homemade anhydrite in lumps ($3/8$ in. x $1/2$ in. x $2/3$ in.) increased in weight 10 mg in 7 min.

*Table, "Efficiency of Drying Agents," p. E-41 of CRC Handbook of Chemistry and Physics, 54th Edition (1973-1974), published by CRC Press, Also see B. D. Power, High Vacuum Pumping Equipment, Reinhold Publishing Corp., New York, pp. 274-277 (1966).

Using a single layer of lumps of anhydrite of the recommended size in a KFM prevents anhydrite from being too close to the aluminum leaves and facilitates removing the lumps without disturbing or dusting the leaves.

Drierite or other commercial anhydrite with a light blue color indicator has an obvious advantage.

B.5.2 Silica Gel

Silica gel, especially with a color indicator that shows its condition as a drying agent, is an effective drying agent for use in a KFM -- as indicated by the tests summarized in the following table. At room temperature, silica gel maintains an equivalent equilibrium water vapor of 0.005 to 0.010 mm of mercury.* However, the dark color of silica gel with a dark blue color indicator makes it difficult to read the KFM leaves suspended above this dark background.

Leakage of Charge in 24 Hours under Normal Conditions from a KFM
with 8-Ply Leaves Supported by Nylon Monofilament Threads,
with Different Drying Agents Inside the KFM

Drying Agent	Leakage of Charge (= Difference in Readings, mm)
Anhydrite (CaSO_4)	0.5
Silica Gel	0.5
Calcium Chloride (CaCl_2)	1.5

*Table, "Efficiency of Drying Agents," p. E-41 of CRC Handbook of Chemistry and Physics, 54th Edition (1973-1974), published by CRC Press. Also see B. D. Power, High Vacuum Pumping Equipment, Reinhold Publishing Corp., New York, pp. 274-277 (1966).

B.5.3 Calcium Chloride

Calcium chloride (CaCl_2) is unsatisfactory for use in a KFM as an air desiccant, as are other salts. Its desiccant action is not as efficient as that of anhydrite or silica gel, and it is corrosive to aluminum. Being deliquescent, it can foul a KFM if left inside too long under humid conditions.

B.6 Three Expedient Charging Devices

Each of the three best expedient charging devices tested produces charges having more than adequate voltages to fully charge a KFM. The 8-ply leaves when fully charged hold a potential of 4000 to 4500 volts.

B.6.1 Plastic Tape Quickly Unrolled

The best types of tape used for this simplest way to charge a KFM produce charges at potentials estimated as high as 90,000 volts* in very dry room air. Other advantages of this method are its extreme rapidity and the fact that it is effective in humid air, unless the relative humidity is greater than about 90%. Disadvantages include the impracticality of unrolling a sticky tape in a 'dry-bucket,' in which a KFM can be charged by either of the two charging methods outlined in subsections 2 and 3, below, even if the relative humidity outside is 100%.

Most brands of plastic tape tested were found to be unsatisfactory charging devices. However, some brands and types of tape that are found in perhaps the majority of American homes serve well for charging a KFM. Scotch Magic Transparent Tape (or other cellulose acetate pressure-sensitive adhesive tape) and Scotch Transparent Tape (very clear) are excellent, and PVC electrical tape (polyvinyl chloride tape) and "vinyl" tapes are good. In contrast, Scotch utility tapes will not charge at all, Scotch Electrical Plastic Tape charges poorly, and Scotch Package Sealing Tape will not charge well except in quite dry air.

*Based on the rule-of-thumb that 30,000 volts are required to jump a spark gap 1 cm wide.

Another disadvantage of even the best-charging tapes is the fact that in storage they deteriorate after a few years.

B.6.2 Hard Plastic Rubbed on Dry Paper

The most effective hard plastic (tested by rubbing it on dry paper) was Plexiglas. Next, in their order of decreasing effectiveness, are hard polyethylene, polyvinyl chloride, and Lexan. Neither the hard polystyrene nor the hard fluorothene would produce a charge.

Dry smooth writing paper and typing paper were the most effective charging papers tested. Dry tissue paper, Kleenex, and toilet paper were almost as good but are not as durable. However, this method of charging suddenly becomes ineffective if the relative humidity is 85% or higher, even if the charging paper and the hard plastic are very dry immediately before use.

Plexiglas rubbed on any dry paper develops a strong positive charge, but it develops a strong negative charge when rubbed on household Saran film. Plexiglas rubbed on Mylar film is also very effective, if the Mylar film has not been treated to prevent the generation of static electricity. Saran and Mylar film absorb less water from humid air but are harder to handle in a dry-bucket than is folded paper.

It is impossible to tell by looking at a hard plastic whether it will charge positive or negative when rubbed. Calibration tests in gamma fields confirmed theory: it makes no difference whether a **KFM** is charged positive or negative.

The authors lacked the equipment necessary to measure the voltages produced by quickly unrolling tape and rubbing Plexiglas on dry paper. The very small charges are transferred to the charging-wire of the **KFM** by spark discharges across distances of up to 3 cm. These small sparks are audible but are visible only in the dark. Use of the rule-of-thumb to determine voltage (30,000 volts are required to jump a spark gap 1 cm wide) indicates that a maximum charging potential of about 90,000 volts is produced in room air that is dry. Most of such a high voltage is lost from a **KFM's** leaves by being discharged from the lower corners of the leaves to the grounded can. However, sufficient charge remains on the leaves to operate the **KFM** in the design mode.

B.6.3 Aluminum-Foil Charger Rubbed on Nylon Cloth, Mylar, or Saran

Figure B.4 shows an aluminum-foil charger having an insulated aluminum-foil strip 2-1/2 in. wide by 4 in. long, suspended on four 1/2-in.-long insulating threads (nylon dental floss). The four threads are attached to a coat-hanger-wire frame measuring 2-1/2 in. by 5 in. where the threads are attached. To keep the aluminum foil from being stretched when it is rubbed, several thicknesses of the foil are first folded over two thicknesses of stout paper measuring 2-1/2 in. by 6 in. One inch of each end of this paper-reinforced aluminum-foil strip is folded over a 2-5/8-in.-long stiffening wire. Then the folded-over ends are taped securely, and the four insulating nylon threads are tied to the ends of the two stiffening wires. A "whisker" of aluminum foil is attached to one corner of the finished 2-1/2-in. by 4-in. aluminum-foil strip; this "whisker" enables the charging-wire of a KFM to be lightly touched and not pushed out of proper adjustment when a charge is being transferred to it (see Fig. B.5).

B.4. Aluminum-Foil Charger.

Fig. B.5. Transferring Charge from the "Whisker" of an Aluminum-Foil Charger.

Although the aluminum-foil charger is a reliable means for charging a KFM, even inside a dry-bucket, this charging device is not included in the already lengthy instructions for making and using a KFM. Spot checks of some 20 families indicated that all these families had access in their homes or in neighbors' homes to hard plastic and paper suitable for charging of a KFM. However, since the aluminum-foil charger is more satisfactory for charging a KFM than are the classical frictional means for producing an electrostatic charge, it is described in this report as an additional illustration of the wide availability in American homes of materials needed to make and charge **KFMs**.

The aluminum-foil charger charges best when rubbed on Mylar film, and effectively when rubbed on kitchen-type Saran film and on nylon cloth that has not received an antistatic treatment, such as most nylon pantyhose receive. Rubbing most polyethylene films was found to be an unsatisfactory charging method.

A 6,000-volt charge was measured on the foil of the aluminum-foil charger, both after it was rubbed on Mylar and on Saran film. Because of the relatively low voltage of the charge produced by this method, it is best to adjust the charging wire of the KFM so that it gently presses the two leaves together, and to touch the upper end of the charging wire with the "whisker" of the aluminum-foil charger, when transferring a charge (see Fig. B.5).

A disadvantage of an aluminum-foil charger is that a little aluminum rubs off the foil and contaminates the insulating material onto which the aluminum foil is rubbed. Therefore, after a few chargings, a different part of the material must be rubbed with the aluminum. Another disadvantage is that the quantity of charge produced is so small that sometimes several transfers of charge to a **KFM** must be made in order to fully charge it.

B.7 Charging a KFM in a Dangerously High Gamma Field

While both a KFM and the Scotch Magic Transparent Tape used to charge it were exposed in a 20-R/hr gamma field, the tape was quickly unrolled. The KFM was charged as rapidly as under normal conditions.

When a similar attempt was made to charge a KFM with an aluminum-foil charging device rubbed on Saran film while both were exposed in a 20-R/hr gamma field, the KFM could not be fully charged. However, this much slower means for producing and transferring an electrostatic charge was successfully used to charge a KFM exposed in a 10-R/hr gamma field.

Exposure of a KFM to a dose of 400 R did not affect its future accuracy.

B.8 Other Means for Charging KFMs and Similar Electroscope-Capacitors

1. The authors tried only one piezoelectric charging device, the Lab-Lyter manufactured by Labconco. This device produces an overly large charge, at a potential of about 13,000 volts, for use in charging a KFM. The large spark discharged from a modified Lab-Lyter apparently causes a breakdown in the insulating value of the air along the path of the spark,, with a resultant "ring effect" that leaves only the last oscillation of the spark discharge on the leaves. This effect results in an indeterminate increase or decrease in the charge remaining on the leaves of a KFM.

2. In order to avoid the complications of having to charge a KFM inside a "dry-bucket" when the air is very humid, several designs of similar instruments were made with various built-in charging devices of friction-electrostatic types. None proved practical. Each prototype of the least unsatisfactory design had a built-in charging device operated via a stiff wire extending to a small handle outside the ionization chamber. Incorporating such an internal device required the can to be made disadvantageously large (a No. 2-1/2 can, or larger). All of these internal devices were quite difficult to build out of materials commonly found in homes, required above-average skill to operate, and did not remain functional long enough.

ORNL- 5040
Dist. Category UC-41

Internal Distribution

- | | | | |
|---------|-------------------------------|------|-----------------|
| 1-3. | Central Research Library | 114. | W. Fulkerson |
| 4. | ORNL-Y-12 Technical Library | 115. | J. S. Gailar |
| | Document Reference Section | 116. | K. S. Gant |
| 5-8. | Laboratory Records Department | 117. | C. M. Haaland |
| 9. | Laboratory Records, ORNL R.C. | 118. | R. F. Hibbs |
| 10-106. | Emergency Technology Library | 119. | C. H. Kearny |
| 107. | J. A. Auxier | 120. | J. Lewin |
| 108. | P. R. Barnes | 121. | J. H. Marable |
| 109. | P. R. Bell | 122. | D. B. Nelson |
| 110. | C. V. Chester | 123. | H. Postma |
| 111. | G. A. Cristy | 124. | M. W. Rosenthal |
| 112. | F. L. Culler | | |
| 113. | L. Dresner | | |

External Distribution

125. Aberdeen Proving Ground, Technical Library, Aberdeen Proving Ground, MD 21021
126. Ronald D. Affeltdt, State Director, North Dakota Disaster Emergency Services, P. O. Box 1817, Bismarck, ND 58501
127. Harold M. Agnew, Director, Los Alamos Scientific Laboratory, Los Alamos, NM 87544
128. Army War College, Library, Ft. McNair, Washington, DC 20315
129. Marion Arnold, Editor, INFO-RAY Radiological Defense Officers Association, 7510 East Fourth Place, Downey, CA 90241
130. Assistant Secretary of the Air Force (R & D), Room 4E968, The Pentagon, Washington, DC 20330
131. Assistant Secretary of the Army (R & D), Attn: Assistant for Research, Washington, DC 20310
132. The Honorable Howard H. Baker, United States Senate, 4123 New Senate Office Building, Washington, DC 20510
133. Raymond J. Barbuti, Deputy Director, Office of Natural Disaster and Civil Defense, N. Y. State Department of Transportation, Bldg. 22, State Office Bldg. Campus, Albany, TN 12226
134. Richard L. Barth, Welfare Services, 50 East North Temple St., Salt Lake City, UT 84150

135. Commissioner William Baumann, Director, Department of Public Safety, Civil Defense Division, Redstone, Montpelier, VT 05602
136. Col. William R. Beaty, Coordinator, Disaster Planning and Operations Office, Civil Defense, 1717 Industrial Drive, P. O. Box 116, Jefferson City, MO 65101
137. M. C. Bell, Animal Husbandry and Veterinary Science, University of Tennessee, Knoxville, TN 37916
138. David W. Bensen, RE(HV), Defense Civil Preparedness Agency, Washington, DC 20301
139. Ezra Taft Benson, 47 East South Temple, Salt Lake City, UT 84111
140. Donald A. Bettge, RE(HV), Defense Civil Preparedness Agency, Washington, DC 20301
141. John E. Bex, DCPA Regional Director, Region 2, Federal Regional Center, Olney, MD 20832
142. Maj. Gen. Edward Binder, Adjutant General & Director, Neb. Civil Defense Agency, National Guard Center, Bldg. 1600, 1300 Military Road, Lincoln, NE 68508
143. George F. Bing, Lawrence Livermore Laboratory, P. O. Box 808, Livermore, CA 94550
144. Bruce Bishop, DCPA Regional Director, Region 4, Federal Center, Battle Creek, MI 49016
145. Robert J. Bosler, Deputy Director and Program Administrator, Basement, State Office Building, Room B-40, Topeka, KS 66612
146. James A. Bowen, c/o Commander, Naval Weapons Center, Code 4563, China Lake, CA 93555
147. M. Parks Bowden, State Coordinator, Division of Disaster, Emergency Services, Texas Department of Public Safety, Box 4087, North Austin Station, Austin, TX 78773
148. William R. Brady, Secretary, U.S. Civil Defense Council, 1301 Farm Rd. 3002, Dickinson, TX 77590
149. John E. Brantley, Civil Defense Director of Oak Ridge, 94 Arkansas Ave., Oak Ridge, TN 37830
150. Donald G. Brennan, Hudson Institute, Quaker Ridge Road, Croton-on-Hudson, NY 10520

151. David L. Britt, Director, N. C. Division of Civil Preparedness, Administration Building, 116 West Jones Street, P. Ø. Box 2596, Raleigh, NC 27603
152. William M. Brown, Research Consultant, 5 Tavano Road, Ossining, N. Y. 10562
153. Arthur Broyles, Department of Physics, University of Florida, Gainesville, FL 32611
154. James O. Buchanan, Defense Civil Preparedness Agency, Washington, DC 20301
155. E. C. Burton, Vice Chairman & Editor, The Institute of Civil Defense, P. Ø. Box 229, 3, Little Montague Court, London, ECIP IHN, England
156. Zbigniew Brzezinski, National Security Advisor, The White House, Washington, DC 20500
157. J. C. E. Button, c/o Counsellor (Atomic Energy), Embassy of Australia, 1601 Massachusetts Ave., N.W. Washington, D.C. 20036
158. Deputy Chief, Canadian Defense Research Staff, 2450 Massachusetts Avenue, N. W., Washington, DC 20008
159. Nicholas L. Caraganis, Director, Bureau of Civil Emergency Preparedness, Dept. of Defense and Veterans Services, State House, Augusta, ME 04330
160. Maj. Gen. Vito J. Castellano, Chief of Staff to the Governor, New York Division of Military and Naval Affairs, Public Security Building, State Office Building Campus, Albany NY 12226
161. William K. Chipman, Deputy Assistant Director, Plans PO(DP), Defense Civil Preparedness Agency, Washington, DC 20301
162. John Christiansen, Department of Sociology, Brigham Young University, Provo, UT 84601
163. Bruce C. Clarke, Jr., Director, Office of Strategic Research, CIA, Washington, DC 20505
164. Maj. General James C. Clem, Adjutant General & Director Disaster Services Agency, P. Ø. Box 660, Worthington, OH 43085
165. M. W. Cortner, 106 Lacy Lane, Clarksville, TN 37040
166. Donald R. Cotter, Assistant to Secretary of Defense (Atomic Energy), DOD, Rm. 3E1069, The Pentagon, Washington, DC 20301

167. Fred C. Craft, Director, S.C. Disaster Preparedness Agency and Emergency Planning Director, Rutledge Bldg., Room B-12, 1429 Senate Street, Columbia, SC 29201
168. Harold A. Crain, Director, Mississippi Civil Defense Council and Office of Emergency Preparedness, P. Ø. Box 4501, Fondren Station, 141Ø Riverside Drive, Jackson, MS 39216
169. R. W. Crompton, Research School of Physical Science, The Australian National University, Ion Diffusion Unit, Box 4, G. P. O., Canberra A. C. T., Australia
170. Daniel J. Cronin, Assistant Director for Conflict Preparedness, Federal Preparedness Agency, General Services Administration, 18th and F Streets, N. W., Room 4224, Washington, DC 20405
171. Director, DCPA Staff College, Federal Center, Battle Creek, MI 49016
172. L. J. Deal, Division of Operational Safety, Department of Energy, Washington, DC 20545
173. Defense Documentation Center, Cameron Station, Alexandria, VA 22314
174. Commander, Field Command, Defense Nuclear Agency, Sandia Base, Albuquerque, NM 871ØØ
175. Defense Supply Agency, Defense Logistics Services Center, Battle Creek Federal Center, Attn: Librarian, Battle Creek, MI 49Ø16
176. Frances K. Dias, DCPA Regional Director, Region 7, P. Ø. Box 7287, Santa Rosa, CA 954Ø1
177. G. W. Dolphin, Assistant Director, R & D, National Radiological Protection Board, Harwell Didcot, Oxfordshire OXII ORQ, England
178. Lt. Gen. Ira C. Eaker, USAF (Retired), 22Ø2 Decatur Place, N. W., Washington, DC 20008
179. P. C. East, Defense Research Establishment OHOWA, NDHQ, Ottawa, Ontario, Canada
180. Guy R. B. Elliot, Los Alamos Scientific Laboratory, P. Ø. Box 1663, Los Alamos, NM 87544
181. The Engineer School, Library, Fort Belvoir, VA 22060
182. Brig. Gen. James Enney, Chief, NSTL Division, JSTPS, Offutt AFB, NE 68113

183. Lee M. Epperson, Director, Office of Emergency Services,
Department of Public Safety, P. Ø. Box 1144, Conway, AR 72032
184. Noel H. Ethridge, 503 E. Lee Way, Bel Air, MD 21014
185. Henry Eyring, -2035 Herbert Avenue, Salt Lake City, UT 84150
186. Jack Finkel, U.S. Naval Ordnance Laboratory, White Oaks,
MD 20910
187. John H. Fisher, Defense Intelligence Agency, Attn: DI 3G
(J. Fisher), Washington, DC 20301
188. F. M. Flanigan, Engineering and Industrial Experiment Station,
College of Engineering, University of Florida, Gainesville,
FL 32611
189. William J. Flathau, Chief, Weapons Effects Laboratory, Waterways
Experiment Station, U.S. Corps of Engineers, P. Ø. Box 631,
Vicksburg, MS 39180
190. Dorothy Fosdick, c/o Senator H. M. Jackson, 137 Old Senate
Office Building, Washington, DC 20510
191. S. David Freeman, Member, TVA Board of Directors, E12, A9, 400
Commerce Ave., Knoxville, TN 37902
192. Charles Fritz, National Academy of Sciences, 2101 Constitution
Ave., N.W., Washington, DC 20418
193. Maj. Gen. Edward R. Fry, Adjutant General & State Civil Defense
Director, Adjutant General's Department, Third Floor, 535 Kansas
Avenue, Topeka, KS 66603
194. Maj. Gen. Richard L. Frymire, Jr., The Adjutant General and
Director Department of Military Affairs, Division of Disaster
& Emergency Services, E. Ø. C., Boone Center, Frankfort, KY 40601
195. R. Quinn Gardner, Managing Director, Welfare Services, 50 East
North Temple St., Salt Lake City, UT 84150
196. Ralph L. Garrett, RE(EO), Defense Civil Preparedness Agency,
Washington, DC 20301
197. C. L. Gilbertson, Administrator, P. Ø. Box 1157, Helena, MT 59601
198. K. Goffey, Natural Disasters Organization, P. Ø. Box 33,
Canberra City, A.C.T. 2600, Australia
199. Leon Goure, Director, Center for Advanced International Studies,
P. Ø. Box 8123, University of Miami, Coral Gables, FL 33124

200. Captain John Graham, AFIS-INC, The Pentagon, Washington, DC 20330
201. Jack C. Greene, Greenwood, Box 85A, Route 4, McKinney Cove, Bakersville, NC 28705
202. Robert J. Gregory, Director, Civil Defense and Disaster Agency, State of Nevada, 2525 S. Carson St., Carson City, NV 89701
203. Col. George L. Halverson, State Civil Defense Director, Emergency Services Division, Department of State Police, 714 South Harrison Road, East Lansing, MI 48823
204. W. Cornelius Hall, President, Chemtree Corporation, Central Valley, NY 10917
205. David G. Harrison, DCPA Regional Director, Region 6, Federal Regional Center, Building 710, Denver, CO 80225
206. Hayden Haynes, Director, Oklahoma Civil Defense Agency, Will Rogers-Sequoyah Tunnel, P. O. Box 53365, Oklahoma City, OK 73105
207. Colonel Heinz-Helmuth Heintzel, Commander Jufrastrakthustab der Bundeswehr, 5000 Kolm, Zeppelinstrasse 15, Mayhans, Germany
208. Col. Oran K. Henderson, Director, State Council of Civil Defense, Room B151, Transportation & Safety Building, Harrisburg, PA 17120
209. Austin Henschel, Occupational Health Research and Training Center, U.S. Public Health Service, Cincinnati, OH 45267
210. Edward L. Hill, Research Triangle Institute, P. O. Box 12194, Research Triangle Park, NC 27709
211. John M. Hill, 2218 Smith Family Living Center, Brigham Young University, Provo, UT 84601
212. Donald C. Hinman, Director, Office of Disaster Services, Lucas State Office Building, Room B-33, Des Moines, IA 50319
213. Maj. Gen. Leonard Holland, The Adjutant General & Director, Defense Civil Preparedness Agency, State House, Providence, RI 02903
214. Donald S. Hudson, RE(SE), Defense Civil Preparedness Agency, Washington, DC 20301
215. Human Sciences Research, Inc., 7710 Old Springhouse Road, Westgate Research Park, McLean, VA 22101

216. Illinois Institute of Technology, Institute Library, Chicago, IL 60616
217. Institute for Defense-Analyses, 400 Army-Navy Drive, Arlington, VA 22202
218. John N. Irwin II, 888 Park Avenue, New York, NY 10021
219. Lowell B. Jackson, University Extension, University of Wisconsin, Madison, WI 53706
220. Herbert W. Johnson, Director, Division of Disaster Preparedness, Department of Community Affairs, 1720 S. Gadsden, Tallahassee, FL 32301
221. R. H. Johnson, School of Nuclear Engineering, Purdue University, West Lafayette, IN 47907
222. Chief, Joint Civil Defense Support Group, Office, Chief-of Engineers, Department of the Army, Attn: ENGMC-D, Washington, DC 20314
223. Maj. General Billy M. Jones, The Adjutant General and State Civil Defense Director, Civil Defense Division, P. O. Box 17965, Atlanta, GA 30316
224. E. E. Jones, Director, Illinois Emergency Services and Disaster Agency, 111 East Monroe Street, Springfield, IL 62706
225. George Jones, State Coordinator Emergency Services, Office of the Governor, 7700 Midlothian Turnpike, Richmond, VA 23235
226. Col. George B. Jordon, USA (Ret.), Director, Division of Emergency Services, 5636 E. McDowell Rd., Phoenix, AZ 85008
227. Herman Kahn, Hudson Institute, Croton-on-Hudson, NY 10520
228. Casper M. Kasparian, Director, DCPA Region One Field Office, Room 2351, 26 Federal Plaza, New York, NY 10007
229. Maj. Gen. George J. Keegan, Jr., USAF (Ret.), United States Strategic Institute, Suite 1204, 1612 K St., N.W., Washington, DC 20006
230. Thomas E. Kennedy, Defense Nuclear Agency (SPSS), Washington, DC 20305
231. H. A. Knapp, Institute for Defense Analyses, 400 Army-Navy Drive, Arlington, VA 22202

232. Foy D. Kohler, Center for Advanced International Studies, P. Ø. Box 8123, University of Miami, Coral Gables, FL 33124
233. Lea Kungle, President, U.S. Civil Defense Council, P. Ø. Box 1381, Joplin, MO 64801
234. Robert H. Kupperman, Deputy Assistant Director, Military & Economic Affairs Bureau, Rm. 5843, U.S. Arms Control & Disarmament Agency, 320 21st Street, N.W., Washington, DC 20451
235. Hans Landberg, Resources for the Future, 1755 Massachusetts Avenue, N.W., Washington, DC 20036
236. Wes Lane, Director, Div. of Emergency Services, Department of Public Safety, B5 - State Capitol, St. Paul, MN 55155
237. Harvey L. Latham, Administrator, Division of Emergency Services, 8 State Capitol, Salem, OR 97310
238. J. L. Liverman, Assistant Administrator for Environment and Safety, Department of Energy, Washington, DC 20545
239. Stephen J. Lukasik, Director, Defense Advanced Research Projects Agency, 1400 Wilson Blvd., Arlington, VA 22209
240. Clarence C. Lushbaugh, Oak Ridge Associated Universities, P. Ø. Box 117, Oak Ridge, TN 37830
241. Rene H. Males, Electric Power Research Institute, 3412 Hillview Ave., P. Ø. Box 10412, Palo Alto, CA 94303
242. Frank Mancuso, Director, State of Connecticut Military Department, Connecticut Office of Civil Preparedness, National Guard Armory, 360 Broad Street, Hartford, CT 06115
243. Charles Manfred, Director, Office of Emergency Services, State of California, P. Ø. Box 9577, Sacramento, CA 95823
244. Col. Donald S. Marshall, 3414 Halcyon Drive, Alexandria, VA 22305
245. Capt. Dan Martens, Field Command, Defense Nuclear Agency, Attn: FCTME, Kirtland AFB, NM 87115
246. J. R. Maxfield, Jr., Radiology and Nuclear Medicine, Maxfield Clinic Hospital, 2711 Oak Lawn Avenue, Dallas, TX 75219
247. George E. McAvoy, Director of Comprehensive Planning, New Hampshire Civil Defense Agency, New Hampshire Military Reservation, 1 Airport Road, Concord, NH 03301

248. Betty McClelland, Director, Department of Emergency Services, State of Washington, 4220 E. Martin Way, Olympia, WA 98504
249. Lt. Colonel James W. McCloskey, Director, Division of Emergency Planning & Operations, Department of Public Safety, P. O. Box C, Delaware City, DE 19706
250. Jerry McFarland, State Director of Civil Defense & Emergency Preparedness, National Guard Armory, Sidco Drive, Nashville, TN 37204
251. William G. McMillan, McMillan Science Associates, Suite 901, Westwood Center Building, 1100 Glendon Avenue, West Los Angeles, CA 90024
252. Phillip S. McMullan, Research Triangle Institute, P. O. Box 12194, Research Triangle Park, NC 27709
253. Capt. Paul McNickle, Air Force Weapons Laboratory (DEP.), Kirtland A.F.B., NM 87117
254. Melvin L. Merritt, ORG 1151, Sandia Laboratories, Albuquerque, NM 87115
255. Julius Meszaros, BRL, Attn: AMXBR-X, Aberdeen Proving Ground, MD 21005
256. Maj. Gen. Franklin E. Miles, The Adjutant General & Director of Office of Civil Emergency Preparedness, Department of Military Affairs, P. O. Box 4277, Santa Fe, NM 87501
257. Col. Milton M. Mitnick, Director, Indiana Department of Civil Defense & Office of Emergency Planning, B-90 State Office Building, 100 North Senate Avenue, Indianapolis, IN 46204
258. K. Z. Morgan, School of Nuclear Engineering, Georgia Institute of Technology, Atlanta, GA 30332
259. Col. Farnham L. Morrison, Director of Civil Defense and Emergency Planning, P. O. Box 44007, Capitol Station, Baton Rouge, LA 70804
260. Walter Murphey, Editor, Journal of Civil Defense, P. O. Box 910, Starke, FL 32091
261. Lt. Colonel M. P. Murray, AF/INAKB, Soviet Strategic Affairs, Lind Building, Room 320, 1111 19th Street, Rosslyn, VA 20330
262. National Civil Defense Administration, 1808 Roxas Boulevard, Manila, Philippines

263. David L. Narver, Jr., Holmes and Narver, 400 East Orangethorpe Ave., Anaheim, CA 92801
264. National Radiological Protection Board, Attn: The Library, Harwell, Didcot, Berkshire OX110RQ, United Kingdom
265. Commander, Naval Facilities Engineering Command, Research and Development (Code O322C), Department of the Navy, Washington, DC 20390
266. Chief of Naval Research, Washington, DC 20360
267. Jiri Nehnevajsa, Professor of Sociology, Department of Sociology, University of Pittsburgh, 3117 Cathedral of Learning, Pittsburgh, PA 15213
268. John H. Neiler, Vice President, ORTEC, Inc., 100 Midland Road, Oak Ridge, TN 37830
269. Edward Newbury, Director, Alaska Disaster Office, State of Alaska, 1306 East Fourth Avenue, Anchorage, AK 99501
270. Paul H. Nitze, 1500 Wilson Blvd., Suite 1500, Arlington, VA 22209
271. John W. Nocita, Office of Preparedness, General Services Administration, Room 4229, ATGC, Washington, DC 20405
272. Brig. Gen. Gunnar Noren, Royal Fortifications Administration, FACK, S-104 50 Stockholm 80, Sweden
273. Col. Harry L. Palmer, Sr., Coordinator, Wyoming Disaster & Civil Defense Agency, P. O. Box 1709, Cheyenne, WY 82001
274. Richard Park, Headquarters NCRP, 7910 Woodmont Ave., Washington, DC 20014
275. Helen L. Parker, Foreign Liaison Officer, Defense Civil Preparedness Agency, Washington, DC 20301
276. W. J. Payne, Director of Communications, City of Lubbock, P. O. Box 2000, Lubbock, TX 79457
277. Daniel N. Payton, Senior Scientist/NT, Air Force Weapons Laboratory, Kirtland A.F.B., NM 87117
278. Robert M. Phillips, Box 5409, Eugene, OR 97405
279. Steuart L. Pittman, Shaw, Pittman, Potts & Trowbridge, Barr Building, 910 17th Street, N.W., Washington, DC 20006

280. Harris M. Pope, Regional Director, Region 3, Federal Regional Center, Thomasville, GA 31792
281. Lisle C. Pratt, Regional Director, Region 8, Federal Regional Center, Bothell, WA 98011
282. J. Howard Proctor, Director, Coordinator Civil Defense Corps, Morgan County Courthouse, Decatur, AL 35601
283. The Rand Corporation, 1700 Main Street, Santa Monica, CA 90406
284. Ren Read, 225 Mohawk Drive, Boulder, CO 80303
285. Dr. H. Reichenbach, Institutsdirektor, Ernst-Mach-Institut, der Fraunhofer-Gesellschaft E. V. Munchen, Eckerstrasse 4, 780 Freiburg, Germany
286. Research and Technical Support Division, Department of Energy, ORO, Oak Ridge, TN 37830
287. Herbert Roback, Staff Administrator, Subcommittee for Military Operations, U.S. House of Representatives, Washington, DC 20515
288. William G. Robinson, Treasurer, U.S. Civil Defense Council, 1100 Laurel St., Baton Rouge, LA 70802
289. George R. Rodericks, Director, Office of Emergency Preparedness, District of Columbia Government, Rm. 5009, Municipal Center, 300 Indiana Avenue, N.W., Washington, DC 20001
290. Joseph Romm, Systems Sciences, Inc., 4720 Montgomery Lane, Bethesda, MD 20014
291. Charles M. Rountree, State Coordinator, Bureau of Disaster Services, State Office Bldg., 650 W. State Street, Boise, ID 83702
292. Rear Admiral Joseph W. Russel, (Ret.), Boeing Aerospace Co., P. O. Box 3999, Mail Stop 85-20, Seattle, WA 98124
293. Cecil H. Russell, Immediate Past President, U.S. Civil Defense Council, Courthouse, Huntington, WV 25701
294. Louis F. Saba, Director, Massachusetts Civil Defense Agency & Office of Emerg. Prep., 400 Worcester Road, Framingham, MA 01701
295. Dr. Eugene L. Saenger, Radioisotope Laboratory, Cincinnati General Hospital, Cincinnati, OH 45267

296. Ronald S. Sanfelippo, Administrator, Division of Emergency Government, Hills Farm State Office Bldg., 4802 Sheboygan Avenue, Madison, WI 53702
297. W. W. Schroebel, 1001 Rockville Pike, No. 1052, Rockville, MD 20852
298. Scientific Advisor's Branch, Home Office, Horseferry House, Dean Ryle St., London, S. W. 1, England
299. Harriet F. Scott, 918 Mackall Ave., McLean, VA 22101
300. F. Seitz, President, Rockefeller University, New York, NY 10021
301. D. B. Shuster, (ORG-1300), Sandia Laboratories, Albuquerque, NM 87108
302. C. R. Siebentritt, P. O. (DC), Room 1D544, Defense Civil Preparedness Agency, Washington, DC 20301
303. Maj. General Valentine A. Siefermann, The Adjutant General & Director of Civil Defense, State of Hawaii, Ft. Rugger, Building 24, Honolulu, HI 96816
304. George N. Sisson, Shelter Research Division, Defense Civil Preparedness Agency, Washington, DC 20301
305. Ray Sleeper, American Security Council Educational Foundation, Boston, VA 22713
306. Howard K. Smith, American Broadcasting Company, 1124 Connecticut Ave., N.W., Washington, DC 20035
307. V. Kerry Smith, Resources for the Future, 1755 Massachusetts Ave., N.W., Washington, DC 20036
308. William E. Smith, President-Elect, U.S. Civil Defense Council, 30 Courtland St., S.E., Atlanta, GA 30303
309. Charles A. Sommer, International Security Affairs Division, Department of Energy, Washington, DC 20545
310. L. V. Spencer, Center For Radiation Research, National Bureau of Standards, Washington, DC 20235
311. Donald R. Spradling, Director, Utah State Office of Emergency Services, State of Utah, P. O. Box 8100, Salt Lake City, UT 84108
312. Stanford Research Institute, Library, Menlo Park, CA 94025

313. A. G. Steinmayer, Advanced Missile Systems, General Electric Company, 3198 Chestnut Street, Philadelphia, PA 19101
314. H. A. Strack, Northrop Corporation, 1791 N. Fort Myer Drive, Arlington, VA 22209
315. Maj. Gen. Allan Stretton, Director-General, Natural Disasters Organization, c/o Dept. of Defense, Russell Offices, Canberra, A.C.T. 2600, Australia
316. Walmer E. Strobe, Stanford Research Institute, 1611 North Kent Street, Arlington, VA 22209
317. LCDR J. D. Strode (FCTMOT), Field Command, Defense Nuclear Agency, Kirtland A.F.B., NM 87115
318. C. J. Sullivan, Director, Civil Defense Department, Administration Bldg. Basement, 64 N. Union, Montgomery, AL 36104
319. Systems Science and Engineering, Inc., 5 Ardley Place, Winchester, MA 01890
320. Systems Sciences, Inc., 4720 Montgomery Lane, Bethesda, MD 20014
321. Frank P. Szabo, Defense Research Establishment, Ottawa, Ontario KIA 0Z 4, Canada
322. Jacob Tadmor, Director, Nuclear Safety, Israel Atomic Energy Commission, Soreq Nuclear Research Center, Yavne, Israel
323. Lauriston S. Taylor, Headquarters NCRP, 7910 Woodmont Ave., Washington, DC 20014
324. Lester D. Taylor, Professor of Economics, University of Arizona, Tuscon, AZ 85721
325. Edward Teller, The Hoover Institute, Stanford University, Stanford, CA 94305
326. John C. Thompson, Jr., Department of Physical Biology, Cornell University, Ithaca, NY 14853
327. Kyle Ø. Thompson, Jr., DCPA Regional Director, Region 5, Federal Regional Center, Denton, TX 76201
328. Bardyl Tirana, Director, Defense Civil Preparedness Agency, Washington, DC 20301
329. Bryce Torrance, American National Red Cross, 18th and E. Streets, N.W., Washington, DC 20006

330. Richard Trankle, Coordinator, Division of Civil Defense, State Emergency Operations Center, State Capitol Bldg., Pierre, SD 57501
331. U.S. Army Engineer Research and Development Laboratories, Library, Fort Belvoir, VA 22060
332. U.S. Naval Civil Engineering Laboratory, Library, Port Hueneme, CA 93041
333. Maj. Gen. Rinaldo Van Brunt, Director, Maryland Civil Defense and Disaster Preparedness, Reisterstown Road & Sudbrook Lane, Pikesville, MD 21208
334. J. Morgan Van Hise, Acting Director, Civil Defense & Disaster Control, Department of Law and Public Safety, P. O. Box 979, Eggerts Crossing Road, Trenton, NJ 08625
335. L. Vortman, Sandia Corporation, P. O. Box 5800, Albuquerque, NM 87115
336. R. C. Watts, Radiological Defense Officer, Department of Civil Preparedness, City Hall, Room 113, Louisville, KY 40202
337. Lee Webster, Advanced Ballistic Missile Defense Agency, Huntsville Office, ABH-S, P. O. Box 1500, Huntsville, AL 35807
338. Richard L. Weekly, Director, Office of Emergency Services, 806 Greenbrier Street, Charleston, WV 25311
339. Alvin M. Weinberg, Institute for Energy Analysis, P. O. Box 117, Oak Ridge, TN 37830
340. Carl F. von Weizsacker, Director Max Planck Institute D-813 Starnberg, Riemerschmidstrabe F, Germany
341. Clayton S. White, President and Scientific Director, Oklahoma Medical Research Foundation, 825 NE 13th Street, Oklahoma City, OK 73141
342. William White, Civil Defense Technical Office, Stanford Research Institute, Menlo Park, CA 94025
343. Macauley Whiting, Vice President, The Dow Chemical Company, 2020 Dow Center, Midland, MI 48640
344. E. P. Wigner, 8 Ober Road, Princeton, NJ 08540
345. J. R. Wilson, Director, National Security - Foreign Relations Division, The American Legion, 1608 K Street, N.W., Washington, DC 20006

346. John Wisotski, University of Denver, DRI, P. Ø. Box 1Ø127,
Denver, CO 8Ø21Ø
347. Colonel Hershel C. Yeargan, Deputy Director, Division of
Disaster Emergency Services, 3ØØ Logan Street, Denver, CO 8Ø2Ø3
348. Edwin N. York, P. Ø. Box 5123, Kent, WA 98Ø31
349. Allan R. Zenowitz, DCPA Regional Director, Region 1, Federal
Regional Center, Maynard, MA Ø1754
- 35Ø-6ØØ. Given distribution as shown in TID-4500 under Health & Safety
category (25 copies --- NTIS)

