

Naca TR-129

**CASE FILE
COPY**
Don't only



REPORT No. 129

**AERONAUTIC INSTRUMENTS
SECTION V**

POWER PLANT INSTRUMENTS



**NATIONAL ADVISORY COMMITTEE
FOR AERONAUTICS**



Reproduced by
**NATIONAL TECHNICAL
INFORMATION SERVICE**
U S Department of Commerce
Springfield VA 22151

**WASHINGTON
GOVERNMENT PRINTING OFFICE
1925**

13

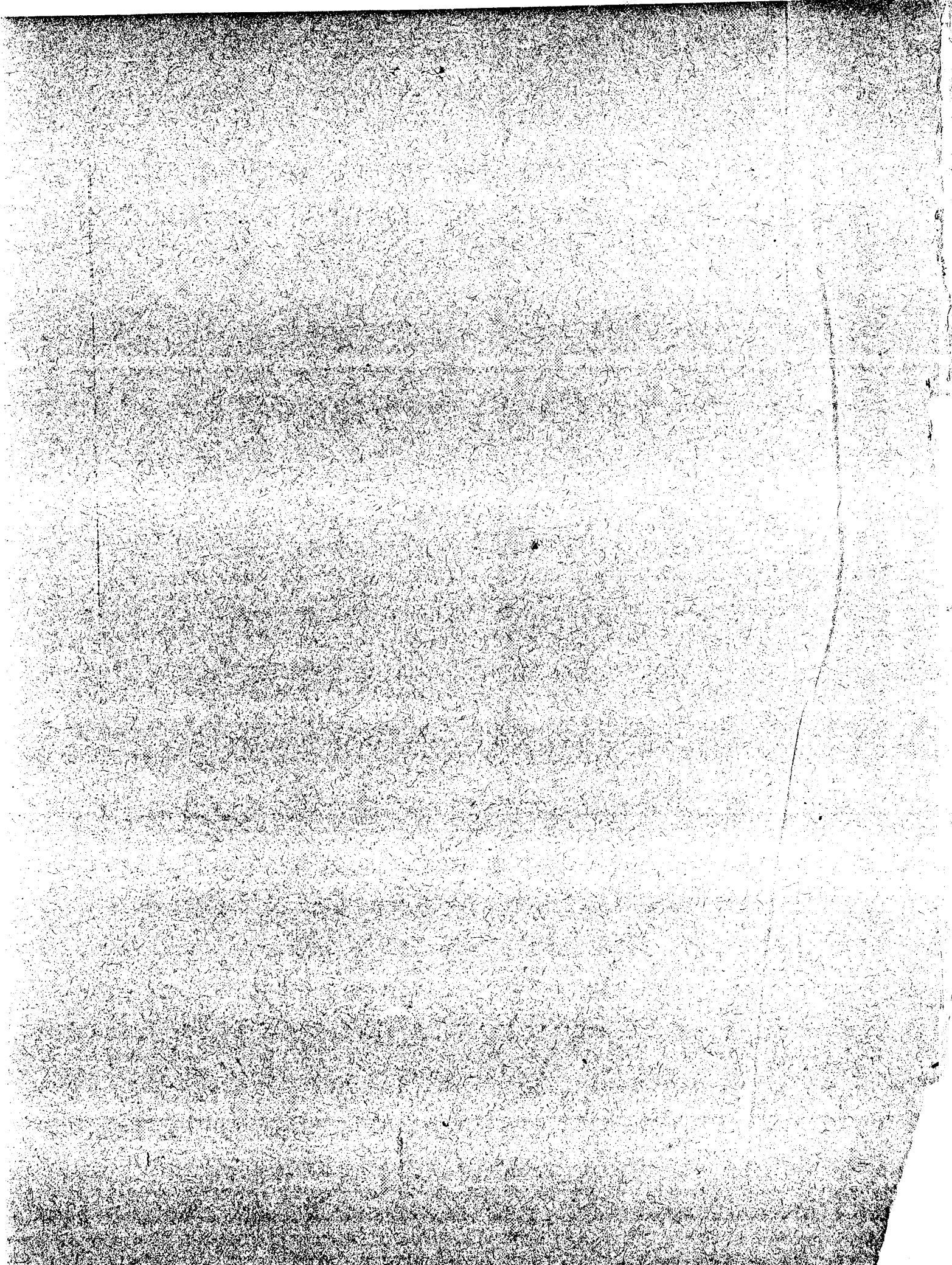

REPORT No. 129

AERONAUTIC INSTRUMENTS
SECTION V

POWER PLANT INSTRUMENTS
IN FIVE PARTS

AERONAUTIC INSTRUMENTS SECTION
Bureau of Standards



REPORT No. 129.

POWER PLANT INSTRUMENTS.

PART I.

AIRPLANE TACHOMETERS.

By G. E. WASHBURN.

INTRODUCTION.

This report is Section V of a series of reports on aeronautic instruments (Technical Reports Nos. 125 to 132, inclusive) prepared by the Aeronautic Instruments Section of the Bureau of Standards under research authorizations formulated and recommended by the Subcommittee on Aerodynamics and approved by the National Advisory Committee for Aeronautics. Much of the material contained in this report was made available through the cooperation of the War and Navy Departments.

SUMMARY.

This part gives a fairly complete discussion of all the various types of airplane tachometers studied at the Bureau of Standards. French, German, and American chronometric tachometers are described in detail; also several types of foreign and domestic centrifugal tachometers. These types, chronometric and centrifugal, were those most extensively used by the Allied and Entente forces. In addition, a description is given of various tachometers of the electric, air viscosity, air-leak, magnetic, mercury viscosity, and liquid centrifugal types which have been used to some extent on aircraft.

USES OF AIRPLANE TACHOMETERS.

The airplane tachometer shows how fast the crank or propeller shaft of the engine is revolving. As a rule it indicates the revolutions per minute, or revolutions per minute of the shaft. It is driven usually by a flexible cable running from the engine to the instrument board.

The tachometer is often spoken of as the "revolution indicator," or "rev. indicator." Revolution indicators, however, show revolutions only, whereas tachometers show speed or rate of revolution.

Tachometers should be distinguished also from speedometers. The latter, though the same in principle, are used for a different purpose; namely, to show the speed of automobiles over the ground in miles per hour.

The principal use of the tachometer is as a detector of engine trouble. Engine trouble of any kind results in a slowing down of the engine. The tachometer, therefore, shows at all times, quickly and surely, whether or not the engine is working properly. The importance of knowing this is apparent, since an airplane depends on its engine, not only for propulsion but also for actual support or maintenance of level.

Tachometers are also used in adjusting the engine to its speed of greatest efficiency, and in performance tests.

Experienced aviators occasionally dispense with the tachometer as well as other instruments. To take the air, however, without first consulting the tachometer is to neglect a simple precaution and is foolhardy. In times of emergency the tachometer may be a great help, and, if working properly, is more reliable in all cases than the senses.

GENERAL INVESTIGATION OF AIRPLANE TACHOMETERS.

Apparatus was designed for investigating and testing tachometers under airplane conditions, such as vibration, change of temperature, and reduced air pressure. Detailed descriptions of apparatus and test methods are given in a later section of this report.

Type tests were made on six types of tachometers with the following results:

1. Chronometric tachometers, which measure speed by recording the amount of motion in a fixed-time interval showed exceedingly small errors throughout but had relatively low durability.

2. Centrifugals, in which the amount of deformation of a spring by centrifugal force indicates the speed, were not at all affected by reduced air pressure and not seriously by change of temperature. The calibration error and the lag were rather large and increased with continued running. Complete breakdowns, however, rarely occurred.

3. Air viscosity tachometers, which act by the viscosity of a thin air film between two concentric cylinders, were not much affected by reduced air pressure, but the temperature error was high. Heat caused an increase, cold a decrease in the reading. The calibration and lag errors were moderate.

4. Air pump tachometers, in which the speed is indicated by the pressure generated by an air pump operated at a speed proportional to the driving speed, were very seriously affected by reduced air pressure. The effect was nearly linear and about 20 per cent at one-half atmosphere (20,000 feet).

5. The magnetic tachometers, depending on the electromagnetic induction between a revolving magnet and a conducting drum or disk, were unaffected by reduced air pressure. They were, however, inaccurate in calibration, strongly affected by change in temperature and inconsistent with running.

6. The electric tachometers, consisting of a magneto used with a voltmeter graduated in revolutions per minute, had fair accuracy, but showed irregular fluctuations and a rather large temperature effect, besides being rather heavy.

Acceptance tests were made on about 300 instruments of the chronometric and centrifugal types, adopted by the Army and Navy, and taken from quantity production. As in the type tests, the chronometrics were found much superior in numerical errors, but inferior in endurance.

An experimental and theoretical investigation was made to improve the centrifugal type which, in view of its simplicity and freedom from breakdowns, seemed especially suitable for military use. A study was made also of master tachometers, of both old and new types, for accurate quantity testing and of special apparatus for rapidly calibrating the same.

TYPES OF AIRPLANE TACHOMETERS.

Airplane tachometers are the same in principle and construction as automobile speedometers; for the speedometer of an automobile, being connected to the forward axle of the machine, records primarily the speed of revolution of this axle and so is really a tachometer. However, because of the more severe conditions and requirements, there are fewer satisfactory types of airplane tachometers than of automobile speedometers.

Tachometers and speedometers are based on simple and well-known principles. Following is a classification of the various types of tachometers together with a brief statement of the principle on which each depends. Afterwards detailed descriptions of individual makes are given.

Chronometric or escapement tachometers.—The speed is measured by the motion of a gear (or toothed rack) in equal intervals of time during which it is connected with the main drive. Since the time intervals are equal, being regulated by an escapement mechanism, the motion of the gear during each interval is proportional to and, therefore, measures the average speed during the interval. The motion of the gear is shown by a pointer moving over a dial graduated in equivalent speeds of revolution.

CHRONOMETRIC TACHOMETERS.

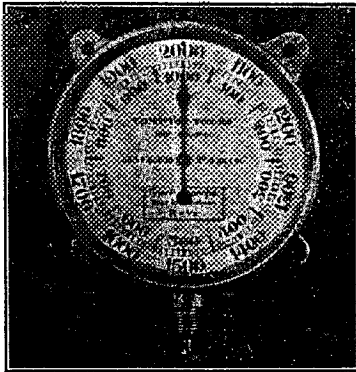

FIG. 1.—Jaeger

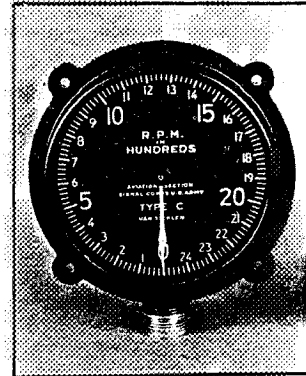

FIG. 2.—Van Sicklen.

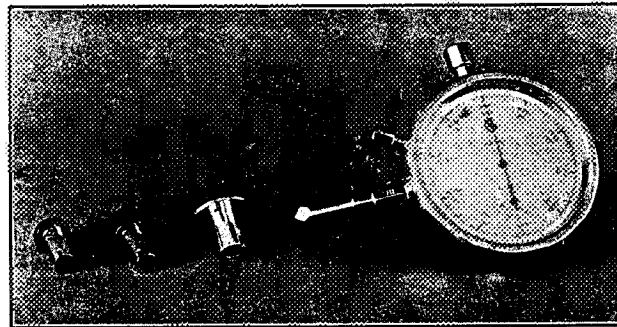

FIG. 3.—Hasler

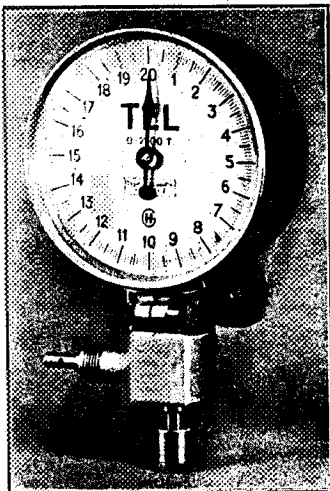

FIG. 4.—French Tel.

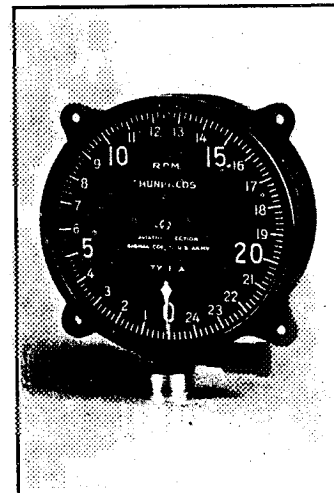

FIG. 5.—American Tel.

The pointer in instruments of this type is locked in position most of the time, changes in speed being indicated by sudden jumps at the ends of the equal time periods. This and the beating of the escapement mechanism, used to regulate the length of the time periods, are the distinguishing marks of this type of tachometer. Figures 1 to 5 show the exteriors of a few chronometric tachometers. Several instruments of this type are described in detail in the section entitled "Chronometric Tachometers."

Centrifugal tachometers.—Centrifugal force or the tendency of a body to fly away from the axis of rotation, which depends on the speed of rotation, acts against the elastic force of a spring. The amount of deformation of the spring determines the motion of the pointer and thus indicates the speed. The deflection, as distinguished from that of the chronometric instruments, is continuous, but in existing types, is not proportional to the speed. In liquid centrifugal tachometers the centrifugal pressure is balanced against hydrostatic pressure. Descriptions of a number of centrifugal tachometers are given in detail below in the section entitled "Descriptions of Centrifugal Tachometers."

Air drag or viscosity tachometers.—A cylinder geared to the main drive exerts a turning force on another cylinder concentric with the first through the viscosity of the thin air film between them. This force acts against a control spring deflecting the pointer by an amount depending on the speed. The deflection, like that of the centrifugals, is continuous, but not proportional to the speed. The Waltham type of air viscosity tachometer is described near the end of this part under the title "Air Drag or Viscosity Tachometers."

Air-pump or air-leak tachometers.—A pump, connected to the main drive, forces air into a chamber with a leak orifice. The pressure thus generated deflects a vane controlled by a spring. The deflection is read off on a scale graduated in corresponding speeds of revolution. A detailed description of the Van Sicklen speedometer is given later in this part under the title "Air-Pump or Air-Leak Tachometers."

Magneto or electric tachometers.—The electro-motive force or voltage of a magneto depends on the speed of revolution of the armature. Hence, a magneto used with a properly graduated milli-volt meter will show speeds of rotation. The Tetco electric tachometer is described in the section entitled "Magneto or Electric Tachometers," near the end of this part.

Magnetic tachometers.—A permanent magnet is revolved near an electrically conducting disk or drum mounted on the same spindle with the pointer and controlled by a spring. In virtue of the electric currents induced in the disk or drum a turning force is exerted on it which deflects it by an amount dependent on the speed. The deflection is read as usual on a scale suitably graduated in speeds of revolution. Two instruments of this type are described in detail near the end of this part under the title "Magnetic Tachometers."

Mercury viscosity tachometers.—The viscous drag of mercury rotating in a steel cylinder tends to carry with it a concentrically mounted steel disk and pointer. The force is balanced by means of one or more control springs. The deflection of the pointer is read on a scale suitably graduated in speeds of revolution. A description of the Atmo type of mercury viscosity tachometer is given later in this part under the title "Mercury Viscosity Tachometers."

Liquid centrifugal tachometers.—A paddle wheel is rotated in a liquid forcing it by means of centrifugal force through a valve into a system of vertical glass tubes. The height of the liquid column indicates the speed of revolution. A description of the Veeder type of liquid centrifugal tachometer may be found under "Liquid Centrifugal Tachometers" at the end of this part.

AMERICAN MILITARY AIRPLANE TACHOMETERS.

These are of the chronometric and centrifugal types. The magnetic type, used to a certain extent before the war, has been abandoned for the present.

These instruments, of whatever type or make, are required to be driven directly without adapter from the cam shaft of the airplane motor. They indicate, however, as stated above, the speed of the crank shaft or double the cam shaft speed. As a rule, therefore, American military airplane tachometers, if driven at a given speed, will indicate twice that speed.

VAN SICKLEN CHRONOMETRIC TACHOMETER.

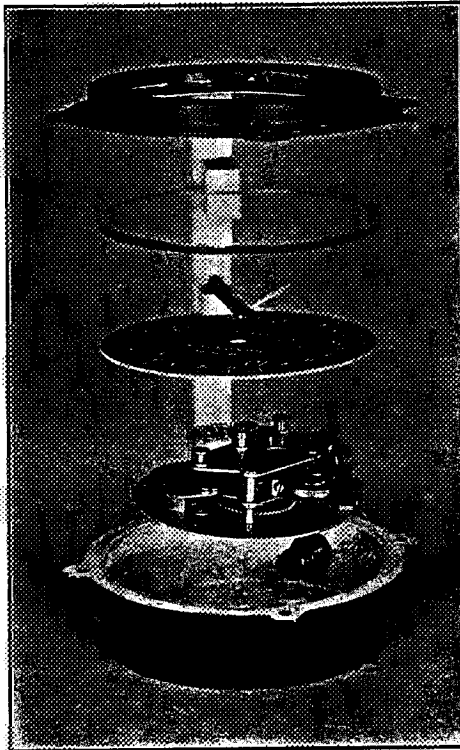

FIG. 6.—Case and Mechanism.

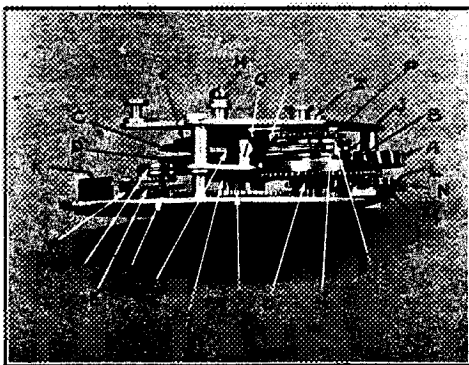

FIG. 7.—Mechanism—Side View.

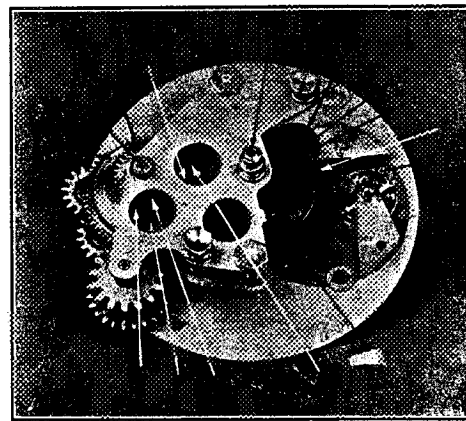

FIG. 8.—Mechanism—Perspective.

Nevertheless, in certain cases, this requirement has been waived and the use of a gear box on the end of the cam shaft, between the cam shaft and the flexible drive, allowed. This arrangement gives greater steadiness, but the adapter is an added complication and undesirable.

The bezels and flexible shaft connections are for the most part standard, independent of type or make, so that instruments are interchangeable. The dials are graduated from 0, 300, 400, or 500 to 2,400, 2,500, or 2,600 revolutions per minute in intervals of 20 or 50 revolutions per minute. The figures on the dial denote hundreds of revolutions per minute. The 0, 5, 10, 15, and 20, as well as the tip of the pointer, are made luminous and the dial plate blackened for night reading.

In the following descriptions of individual makes those used on American airplanes are treated first and in greatest detail.

VAN SICKLEN CHRONOMETRIC TACHOMETER.

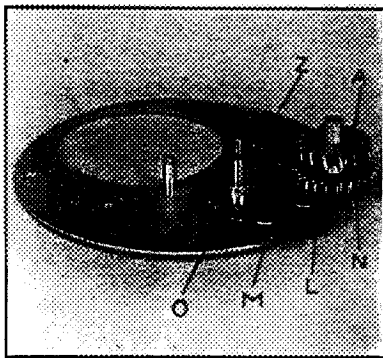

FIG. 9.—Drive System.

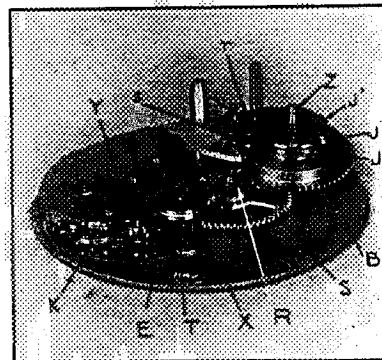

FIG. 10.—Escapement—Cam System.

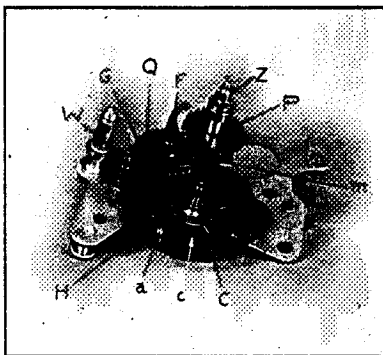

FIG. 11.—Counting System.

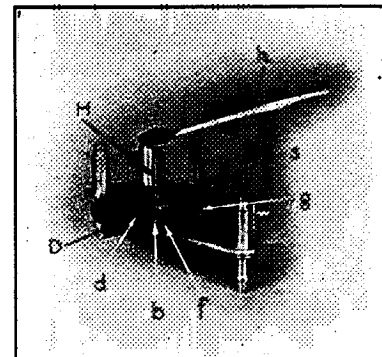

FIG. 12.—Indicating System.

CHRONOMETRIC TACHOMETERS.

Van Sicklen.—This instrument, "Type C" of the American military airplane tachometers, is a simplification and, in some respects, an improvement over the Jaeger chronometric tachometer described below. The complete instrument has already been shown in figure 2. Figures 6 to 8 show the case and mechanism. The gear referred to above, which is connected with the engine for equal intervals of time and the motion of which measures the speed of the engine, is the gear (C) called the counter gear. (K) is the escapement which regulates the length of time intervals.

The mechanism may be divided into the (1) drive, (2) escapement-cam, (3) counting, and (4) indicating systems (figs. 9 to 12). The drive system drives the counting and escapement-cam system. The escapement-cam system controls the operation of the counting and indicating systems. The motion of the counter gear is registered on the dial by the indicating system.

The drive system, figures 7, 8, and 9, begins with the main drive gear (A). It is composed of the gears (N), (L), (M), and (O). Its immediate purpose is to drive the spindle (Z) to which (O) is fixed and from which the counting and escapement-cam systems receive their motive power.

The gears (L) and (M) form a reversing mechanism which automatically provides for a rotation of (Z) in the same direction regardless of the direction of drive. This is necessary because the counting and escapement-cam systems operate in one direction only. The method of reversing is as follows: Gears (L) and (M) are mounted on a rocker arm pinned in the center in such a way that when gear (A), and consequently (N), rotates in one direction clockwise, as seen in figure 8, (L) meshes with (O) and (M) idles without meshing with (O). When, however, (A) rotates in the opposite direction, (M) meshes with (O) and (L) merely drives (M) idly. (O) and (Z) rotate in the same direction in either case.

The escapement-cam system, figures 7, 8, and 10, is composed of the cams (J), (J'), and (J''), the toothed barrel (B) to which the cams are fixed, the gears (R), (S), and (T), the fly (E), and the double-roller escapement (K).

(B) receives from (Z), as described below, the motive power for the system. (R), (S), (T), and (E) transmit this power to the escapement which is driven thereby and allows the entire system, including the cams, to move suddenly at regular intervals. The operations of the counting and indicating systems, which are controlled directly by the cams, thus occur in a definite time order.

The releasing is done through (E), which engages a star pinion (Y) on the same pivot with the escape wheel. (E) has two arms and rotates through 180° at each release. The force of impact with the fly is lessened by the inertia wheel (X), which grips by friction the pivot on which (E) is attached.

The motion of the system being fixed, and that of (Z) variable, a slip drive must be used. This is in the form of a spring, called the mainspring, coiled up tightly inside of (B). The inner end of the spring is fastened to (Z). (B), on the other hand, idles on (Z) and also has no rigid connection with the spring. Consequently, as (Z) revolves, the spring slips around in (B). It exerts, however, on (B), through the friction caused by its tendency to uncoil, a turning force which drives the system. This force acts instantly when the instrument is started and continues at all driving speeds. The counting system, figures 7, 8, and 11, consists of the gear (Q), the fine toothed pinion (F) fixed to (Q), and the counter gear (C). The system is driven by the gear (P) fixed to (Z) and meshing with (Q). (F) and (Q) are mounted on a rocker arm (G), which the cam (J) causes to oscillate about a pivot (W) toward and away from (C). (F) is thus thrown alternately into and out of mesh with (C). (Q), however, remains in mesh with (P). The effect is, therefore, to put (C) successively into and out of connection with (Q) and hence with the main drive (A).

This occurs at regular intervals, in fact every second, since (J) is equally spaced and moves, as pointed out above, at regular intervals. The angle, through which (C) is rotated during each second is, therefore, proportional to the speed during the second. (C) is provided with a control spring (c) and a projecting stud (a) on its upper and under sides, respectively. It is locked and released by the toothed pawl (r) operated by the cam (J').

The indicating system (figs. 7, 8, and 12) is formed by the so-called pointer gear (D), similar to and below (C), the pointer spindle (H), to which (D) is fixed but on which (C) idles, the floating arms (f) and (g) pivoted on (H) between (C) and (D), and the pointer (h). Locking and releasing of (D) is accomplished by a toothed pawl (s) similar to and directly below (r) and operated by the cam (J). Unlike (C), (D) has ratchet instead of V teeth and can move forward while in contact with (s). It is provided with a control spring (d) similar to (c) and a projecting stud (b) on its upper side.

(b), (f), (a), (g), and a fixed stop (m) on (G) are arranged so as to engage each other in the order named. The engaging of (a), (g), and (m) stops (C) in a certain position. The engaging of (b), (f), and (a) holds (C) and (D) fixed with reference to each other.

The use of the floating arms (*f*) and (*g*), instead of direct contact of (*a*), (*b*), and (*m*), enables nearly two complete revolutions of (*D*), thus making a full circumference dial possible and insuring against injury in case of overspeeding.

When the instrument is idle, the control springs (*c*) and (*d*) cause (*b*), (*f*), (*a*), (*g*), and (*m*) to engage in the above manner. (*C*) and (*D*) thus assume definite zero positions.

In the operations of the instrument (*C*) and (*D*) are rotated away from (*m*) against the force of their control springs by (*F*) which drives (*C*) and hence (*D*) through the engaging of (*a*), (*f*), and (*b*). They are rotated back toward (*m*) by their control springs. By means of (*r*) (*C*) may be held when out of mesh with (*F*). Similarly (*s*) serves to hold (*D*) independently of (*C*). (*C*) turns back and forth continuously, returning to its zero position at regular intervals. (*D*), however, turns only when a change in speed occurs, forward for an increase, backward for a decrease.

If (*D*) is not in the zero position with reference to (*C*), that is, the position in which (*a*) and (*b*) are in contact with (*f*), it will always move back into that position, when free to do so, by the action of its control spring. The angular deflection of (*D*) and (*h*) from their zero positions is then equal to that of (*C*), which, as seen, is proportional to the speed. Accordingly, so long as the period of the escapement does not vary, the scale of this instrument is uniform.

The cycle of operations is determined by the cams (*J*), (*J'*), and (*J''*). At the start (*C*) is in its zero position and unlocked. (*D*) and (*h*) are locked in the position which they assumed in the preceding cycle. (*F*) meshes with (*C*) for one second, turning it through a certain angle. According as the speed is (1) the same as (2) greater than or (3) less than in the last cycle, (*C*) (1) just reaches (*D*) or (2) engages (*D*) and pushes it forward or (3) stops short of (*D*). In any case (*r*) locks (*C*) in its extreme position, (*s*) then releases (*D*), allowing it in case (3) to assume the zero position relative to (*C*). Next (*C*) is again released and returns to its zero position. The cycle then repeats itself.

The pointer (*h*) follows the motions of (*D*). It is locked at a reading equal to the speed during a given second of mesh of (*F*) with (*C*) from the end of that second to the end of the next. It then moves forward or backward suddenly by an amount equal to the change in speed. This instrument, like others of the chronometric type, therefore, deflects intermittently, indicating the average speed over an interval of time rather than the speed at each instant.

The scale is closed and graduated from 0 to 2,500 revolutions per minute in intervals of 20 revolutions per minute. The instrument is driven directly from the cam shaft without adapter.

Compared with foreign chronometrics, the Van Sicklen has only one counter gear, the reversing mechanism is simpler and the escapement of considerably smaller size. The first is a simplification, but necessitates the instrument remaining idle for part of the time. Worth mentioning is the method of fastening the pointer which is driven onto a square boss and held by a spring washer to prevent slippage from the sudden jumping of the pointer in tachometers of the chronometric type.

Tel.—This instrument, used by the American military forces and known as "Type A," is shown in figure 5. It is a copy of the French instrument shown in figure 4. Figures 13 to 16 show the mechanism. It contains drive, escapement, counting and indicating systems which perform the same functions as in the Van Sicklen. However, the counting member is a toothed rack instead of a gear. Also, the driving and locking devices are not brought into connection with the counter, but the counter with them by a motion at right angles to its counting motion.

The drive system, figure 17, consists of the main drive gear (*A*), fastened to the arbor (*S*) and meshing with a pinion on the drive spindle of the instrument, the gear (*N*), also attached to (*S*), and the gears (*L*), (*M*), (*O*) and (*P*). Its function is to turn the spindle (*Z*), figures 18 and 19, to which (*P*) is fixed and from which the counting and escapement systems are driven.

(*Z*) must revolve in the same direction independent of the direction of drive. This is accomplished by means of a reversing mechanism formed by the gears (*N*), (*L*), (*M*), and (*O*). (*L*) and (*M*) are mounted on a rocker (*T*), idling on (*S*), and are in permanent mesh with (*N*). (*O*) is pivoted on a stud fastened to the frame and is in mesh with (*P*). According as (*A*)

rotates clockwise or counterclockwise, the friction between (S) and (T), which is increased by the slip spring (D), rotates (T) slightly one way or the other and causes (L) to mesh with (P), (M), and (O) idling, or (M) with (O), (L) idling. The direction of rotation of (P) is the same in either case. The screw head (E), playing in the slot (G), serves as a stop for (T).

The escapement system (fig. 18) is composed of the toothed barrel (B), the shaft (J), and the double-roller escapement (K). (J) has fastened to it at one end the gear (R) meshing with (B), at the other end the escape wheel (U). The motive power for the system, which is applied, as in the Van Sicklen, by means of a slip spring, called the mainspring, fastened to (Z) and coiled up inside of (B), is transmitted through (P) and (J) to (K), which releases it and allows the system, including (J), to move suddenly at regular intervals. The time for one

TEL CHRONOMETRIC TACHOMETER.

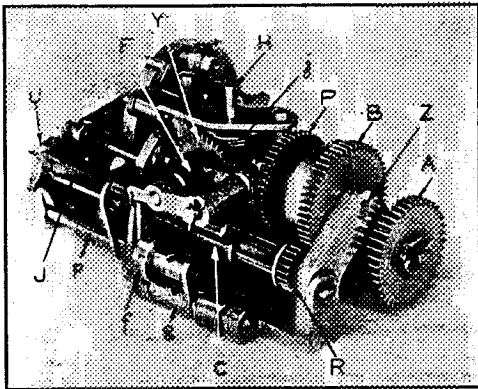

FIG. 13.—Perspective.

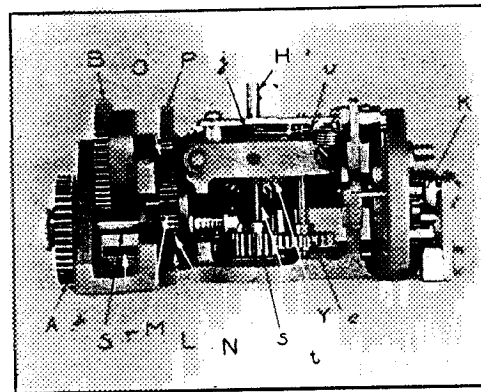

FIG. 14.—Side View.

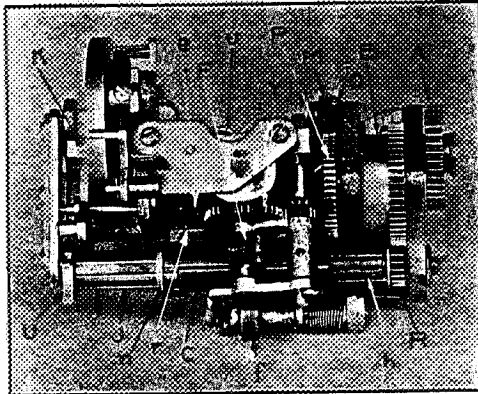

FIG. 15.—Top View.

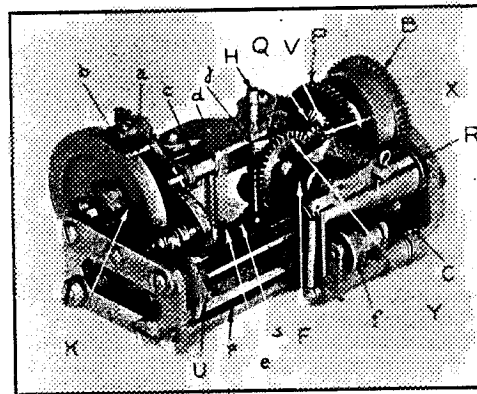

FIG. 16.—Perspective.

swing of the balance wheel is one-quarter second and 12 swings are required for a complete revolution of (U). (J) thus makes a complete revolution in three seconds in steps of one-twelfth of a revolution every quarter second.

The escapement, as seen, is very heavy. To facilitate starting, it is fitted with an auxiliary device which stops it shortly after the instrument is stopped, thus preventing the mainspring from unwinding completely, and also stops it with tension in the escapement spring. The arrangement is such that, when the pointer returns to its zero position, a pin (a) falls automatically, engaging a stud (b) on the rim of the balance wheel and stops the escapement. The movement of (a) is accomplished through a pin (c) which drops into a slot in the upper end of the arbor (d) connected to the pointer staff (H) through the gears (e) and (s).

The counting system, figure 19, is made up of the fine-toothed pinion (F), connected with (Z) through the gear train (Y-X-V-Q), the toothed racks (C), and the cylindrical pawl (*f*). The racks, in the form of three identical cylindrical arcs of 120° each, envelop the shaft (J) along which they are free to slide in grooves. Their zero position is against (R), which position they tend to assume by the action of the helical control springs (*h*) lying in grooves and fastened respectively to (J) and to the racks. (F) and (*f*) are held in contact with the racks by the springs (*k*) and (*m*) attached to the rockers (*g*) and (*g*) in which they are mounted.

As (J) rotates, clockwise viewed from the escapement end, each rack is successively (1) engaged by (F) and carried, by its rotation, along (J) from (R) toward (U) against the force of its control spring; (2) caught and held by (*f*) in the position in which it is left by (F); (3) disengaged from (*f*) and drawn back to the zero position by its control spring.

TEL CHRONOMETRIC TACHOMETER.

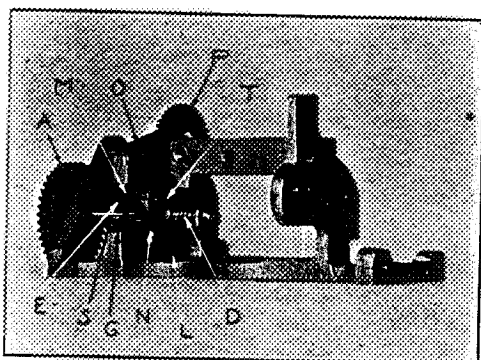

FIG. 17.—Drive system.

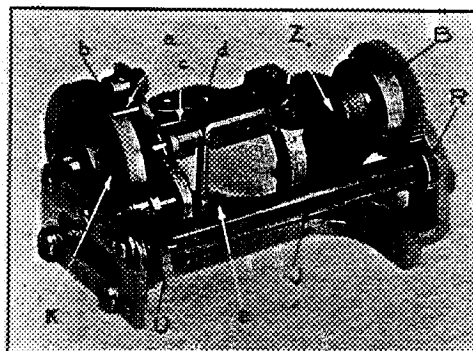

FIG. 18.—Escapement system.

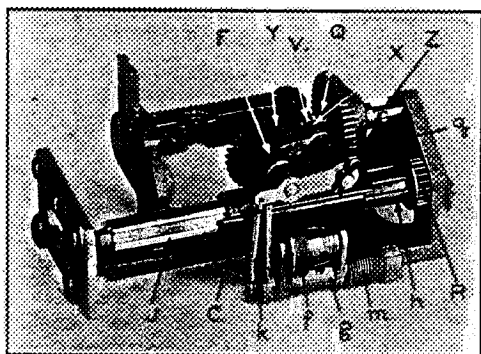

FIG. 19.—Counting system.

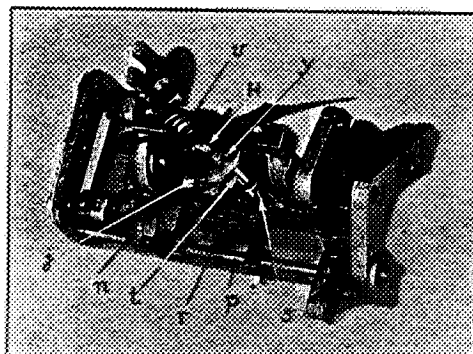

FIG. 20.—Indicating system.

Since the distances between the points of contact of (F) and (*f*) and the width of the racks are each 120° , the above operations follow each other without interruption or overlapping, have each one second, a third of the period of revolution of (J), allotted to them and are performed by the racks with a successive phase difference of one second. Consequently one of the three racks is engaged in each of the three operations at every instant and the instrument is never idle.

Now (F), being geared directly to (Z), and hence to the main drive (A), rotates at a speed proportional to the driving speed. Also, as seen, the period of mesh of the racks with (F) is constant and equal to one second. Therefore, the distances the racks are moved along (J) are proportional, so long as the escapement is unaltered, to the speed during successive seconds. Thus, the rack which is held by (*f*) during each second is at a distance from the zero position of the racks proportional to the speed during the preceding second.

The indicating system, figure 20, is formed by a collar (n) encircling (J) loosely, a toothed rack (r), which slides on a road (p) and to which (n) is attached, and a gear (s) fixed to the pointer staff and meshing with (r). The racks, as they travel along (J), engage (n) and thus move (r), (s), (H) and the pointer. A control spring (t) opposes the motion taking up the backlash between (r) and (s) and keeping (n) in contact with the racks.

(n) rests, in its zero position, against all three racks in their zero position and during, each second, as the instrument operates against the rack held by (f) in that second. The displacement of (n) and (r) from their zero position is, therefore, the same as that of the rack and hence proportional to the speed during the preceding second. (r) and (s), however, constitute a simple rack and pinion, so that the angular displacement of (s) and of the pointer from their zero positions is proportional to the linear displacement of (r) and thus proportional to the speed. This instrument, therefore, has a uniform scale.

It does not, however, show the speed at each instant, but the average speed for periods of one second. It indicates throughout a given second the average speed during the preceding second. Then at, or very near, the end of the second the reading changes suddenly to the value for that second. This reading is maintained for the next second and so forth.

Changes in reading take place at the ends of the second periods because it is then that (n) shifts from one rack to another. If an alteration in speed occurs, the succeeding rack either (1) stops short of the preceding rack, which is in mesh with (f) and against which (n) is resting (decreasing speed), so that, when the latter is released, (n) is drawn backward by (t) into contact with the former; or (2) engages (n) a little before the close of the second (increasing speed), lifts it off the end of the preceding rack and pushes it forward suddenly, holding it on coming to rest. In both cases the change in reading is abrupt and occurs practically at the end of the second period. If the speed is constant, each succeeding rack stops just abreast of the preceding one and no change in the position of (n) or the pointer occurs.

A loose pin-and-hole connection (y) (figure 20) inserted between (H) and the pointer serves to remove fluctuations of the latter due to imperfect mesh of the racks with (F) and (f) at the expense, however, of accuracy and sensitivity. The spring (y) bearing in the threaded rim of the disk (j) acts as a damper for this arrangement and, by the dropping of its curved end into a slot in the disk, as a zero lock for the pointer. The threads prevent this action at full scale deflection.

The maximum possible lag in this tachometer, between a change in speed and its indication on the dial, is seen to be one second.

The dial is graduated in identical manner with that of the Van Sicklen and the instrument also runs without adapter.

Jaeger.—This instrument has already been shown in figure 1, and in figures 21 to 23 are perspective, top, and side views of the mechanism.

The Jaeger, widely used on French airplanes, is an intricate and beautifully made chronometric of the gear type, to which the Van Sicklen is closely related. Unlike the latter, however, it has two counting gears (C) and (C') and thus operates continuously. The mechanism conforms to the usual chronometric type. The drive is through a crown wheel (A) engaged by a pinion bearing in the case of the instrument. From (A) through a reversing mechanism, considerably more complicated and delicate than that of the Van Sicklen or TEL, the rotation is transmitted to the spindle (Z) and to the fine-toothed pinions (F) and (F') which are thrown into and out of mesh respectively with (C) and (C') at regular intervals. From (Z) the escapement (K) and the cams (J) are driven through the usual spring and barrel (S). The pointer gear (D) is midway between (C) and (C') and these gears have corresponding to them the three locking arms (L). Between (D) and the pointer staff is a loose pin and hole connection similar to that in the TEL and serving the same purpose.

The method of meshing and unmeshing (F) and (F') with (C) and (C') is somewhat different from that employed in the Van Sicklen. Namely, the spindles to which (F) and (F') are fastened bear at their upper ends only in the oscillating rocker (G). The lower ends have fixed

JAEGER CHRONOMETRIC TACHOMETER.

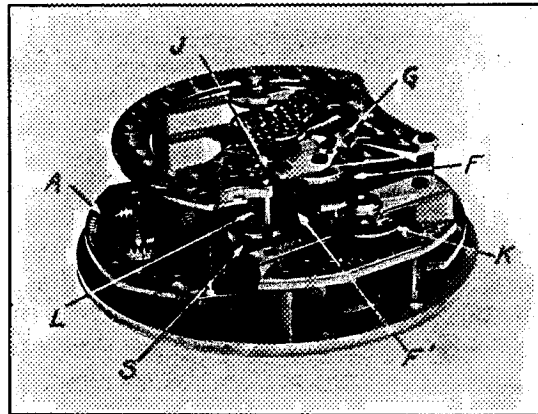

FIG. 21.

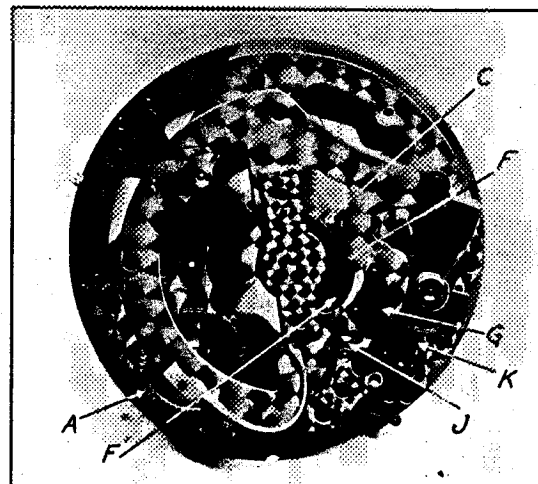

FIG. 22.

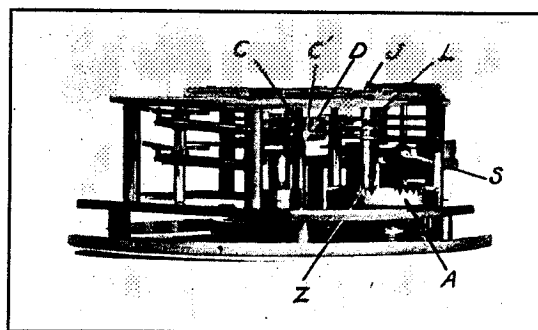

FIG. 23.

Reproduced from
best available copy.



bearings in the frame of the instrument, about which as centers the spindles and gears swing, due to the motion of (G). Thus (F) and (F') are thrown into and out of mesh with (C) and (C'). The driving pinions are fastened to the spindles close to their lower ends where the swinging motion is small, whereas (F) and (F') are attached near the upper ends and so have considerable motion.

The escapement is about as heavy as in an ordinary alarm clock and of the double-roller type. The balance wheel bearings are jeweled. The escape wheel spindle has a light spring bearing against it to prevent rotation backward during the interval between release of one fly arm and contract with the other arm, which would cause irregularities in the counting periods.

The control springs in this instrument are helical or flat plate springs and act indirectly through toothed sectors and pinions on their respective spindles. The counter gear sectors have slender flat springs lying in slots in their faces. These are provided at their free ends with teeth which project beyond the sector teeth at the point of mesh with the pinion on the counter-gear spindle when the instrument is at rest. By the action of the springs these teeth mesh tightly with the pinions and thus eliminate backlash which, owing to the resulting uncertainty in the zero position of the counter gear, may cause a considerable error in reading of the instrument.

Stover-Lang.—The counting element in this tachometer is a radial arm which is lowered at regular intervals into mesh with a rotating crown wheel geared to the main drive spindle. An auxiliary arm, interposed between the counter and the pointer system, is arranged to drop back into contact with the counter shortly before the end of the counting period. It is then carried forward by the counter during the remaining motion of the latter and is held in the extreme position of the counter by ratchet action. The pointer system is then released and assumes the position of the auxiliary arm. The counter itself is not locked at all. The escapement is of alarm-clock size and unjeweled.

The instrument has been arranged for use with an air drive consisting of a diaphragm operated by an eccentric fixed to the rotating shaft. This diaphragm gives puffs of air with a frequency equal to that of the rotation which, being transmitted to the instrument through a tube, operates a ratchet engaging the main drive gear of the mechanism.

This form of drive is free from many defects of the flexible cable, but is intermittent in its action, and as yet has been adapted to chronometric tachometers only.

Hasler.—This instrument, shown in figure 3, is a hand chronometric suitable for tests on airplane motors and other tachometers.

The escapement functions only when one of the two push buttons seen projecting from the edge of the case is pressed and released. Furthermore, it marks off but one period, three seconds in length, during which the counter is connected with the main drive and the pointer carried through a certain angle proportional, as usual, to the speed. The pointer is locked automatically in its final position and the speed is read off. Resetting of the pointer is accomplished by means of the other push button. Ten revolutions of the pointer, giving a total range of 10,000 revolutions per minute, are provided for.

Bruhn.—This instrument, shown in figures 24 to 27, is a German chronometric of the gear type. It is very similar in design to the French Jaeger and the American Van Sicklen.

Like the Van Sicklen, it has only one counting gear; the counting period, however, is one-half second, thus giving a resetting of the pointer at the end of each second. The drive is through a bevel gear meshing with the gears (A), figures 25 and 26, which are arranged in such a way as to idle when driven in one direction and drive through to the gear fixed to the spring barrel (B) when driven in the opposite direction. The barrel (B) is always driven in the same direction for either rotation of the drive gear.

The drive continues from (B) through a coiled slip spring to the staff (S), escapement (K), and back to the cams (J), which control the meshing of the counting pinion (F) with the counting gear (C), and also the operation of the holding pawls (P) for the counting gear (C), and (M) for the pointer gear (C'). There are three pawls (P) and two (M), the pawls (P) being spaced one-third of a tooth out of phase with each other and the pawls (M) one-half of a tooth out of phase.

The escapement (K) is of the double-roller type, unjeweled, and much more rugged than that of either the Van Sicklen or the Jaeger.

A noteworthy feature is the addition of the two odometers (L) and (O). (L) is driven through a train of gears from the staff on which the cams (J) are fixed and shows the number of hours which the instrument, and therefore the engine, has run. (O) is connected to the drive gear, and its readings, multiplied by 100, give the total number of revolutions which the crank shaft of the engine has made.

BRUHN CHRONOMETRIC TACHOMETER.

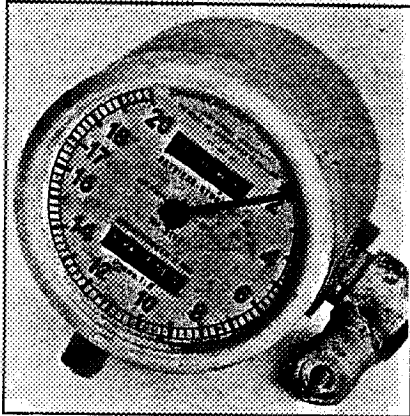

FIG. 24.

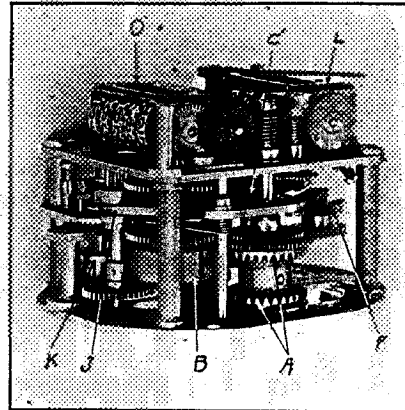

FIG. 25.

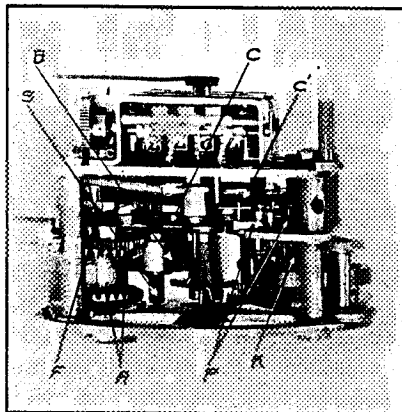

FIG. 26.

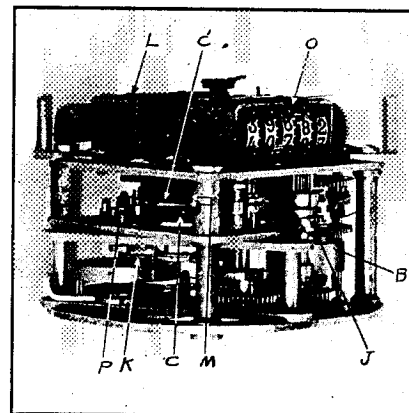

FIG. 27.

CENTRIFUGAL TACHOMETERS.

TYPES OF CENTRIFUGAL TACHOMETERS.

The most common types of centrifugal tachometers are the so-called governor and oblique-weight types.

The governor type is thus named because of the resemblance of the rotating part to an ordinary engine governor. It consists, namely, of a shaft (A), (fig. 28), with a set of weights (B) grouped about it which, as the shaft rotates, act by centrifugal force on a control spring (E). The shaft (A) is hardened and polished, and is mounted vertically and centrally in ball bearings either in the case of the instrument itself or in a separate frame. The weights (B) are attached by links above to a spider (C) fixed to the shaft and below to a grooved collar (D), free to slide along the shaft. The spring E, which is helical, encircles the shaft between (C) and (D).

When the system rotates, the weights (B) pull outward on the links. (D) is thus drawn up the shaft and (E) is compressed. Ultimately, for a fixed speed, the weights and (D) assume a definite position in which the centrifugal force is just counterbalanced by the elastic force of the spring. The motion of (D), which is small ($\frac{1}{4}$ to $\frac{3}{8}$ inch), is magnified and changed into a pointer motion by the indicating train, consisting of the pin (F) bearing on (D), the toothed sector (G), and the pinion (H). The spring (J) on the pointer staff keeps (F) in contact with (D) and also takes up the backlash between the sector and pinion.

In the oblique-weight type, shown diagrammatically in figure 29, the rotating element consists of a weight or frame (B) encircling the main shaft (A) and free to rotate about a spindle (C) fixed perpendicularly to (A). In the position of rest (B) is oblique to (A), but when rotating tends to rotate about (C) into a position perpendicular to (A). This motion is opposed by a control spring (E), so that at each speed a definite position is reached in which the centrifugal couple exerted by (B) is just balanced by the restoring torque of (E). Thus the motion of (B), imparted to the pointer through a suitable indicating train, such as shown in figure 30, gives an indication of the speed. The double oblique-weight type has two crossed weights pivoted on the same axis and placed symmetrically about the shaft.

Other forms of centrifugal tachometers not belonging to the above types will be pointed out in the discussion of individual makes, together with various modifications of the control spring and indicating train.

Centrifugal tachometers used on American airplanes are all of the governor type, but the governor weights differ in size. This necessitates a difference in the running speed, since the control springs and indicating trains are practically alike. The light governors, therefore, must run at higher speed than the heavy ones to give the same deflection. In all cases, however, the speed of the governor is equal to or greater than the indicated or crank shaft speed; that is, equal to or greater than twice the driving or cam shaft speed. Consequently gears giving an increase in speed of one to two or more are necessary. The speed of the governor relative to the indicated speed and the location of the gears, whether within the instrument or in a special adapter on the end of the cam shaft, are pointed out in each case below.

The oblique-weight type, though extensively used abroad, especially in England and Germany, has not yet been adopted in America for use on airplanes.

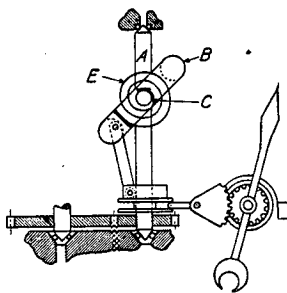

FIG. 29.—Oblique weight type.

Johns-Manville.—This instrument, shown in figure 30, is "Type B" of the American military airplane tachometers. It is of the heavyweight slow-speed type, the governor running at indicated or crank shaft speed. The speed ratio between the cam shaft and the governor is, therefore, one to two. The gears for accomplishing the change in speed are in a separate adapter on the end of the cam shaft, since it was thought, from experiments on sample instruments, that too great unsteadiness would result if they were placed in the instrument itself. Later, however, a model was designed with the gears in the instrument, but this was not produced extensively.

The governor has three weights of special shape which touch when at rest, forming a continuous girdle around the shaft. The ball bearings are contained in the case itself, the upper one being adjustable, the lower one fixed. This is because the weight of the governor falls on the lower bearing.

The indicating train, seen at the left in figure 30, is of the type shown in figure 28 and is carried by a bridge spanning the front of the case. The contact piece which bears on the sliding collar is a pivoted shoe of hard fiber. This is believed to wear better than steel and to be less apt to scratch the surface of the collar. The arm carrying the fiber shoe is adjustable on the spindle on which it rotates, but is not adjustable in length. The pointer is driven on to the

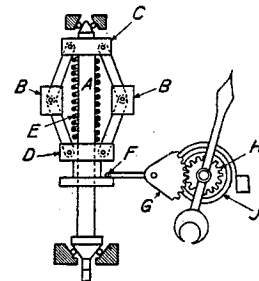

FIG. 28.—Governor type.

tapered end of the pointer staff, and so is also adjustable. Calibration is accomplished by resetting and bending the shoe arm, adjusting the pointer and deforming the control spring.

The scale is graduated from 400 or 500 to 2,500 or 2,600 revolutions per minute, respectively, in intervals of 50 revolutions per minute and has an angular length of about 190°.

Jones "Victometer".—This instrument, shown in figure 31, is used almost exclusively by the Navy. It has very light weights and the governor runs at twice indicated or four times driving speed. The gears having this latter ratio are contained in the instrument itself as seen in the figure.

The ball bearings are set in a ringlike frame of which the bridge carrying the indicating train is an integral part and to which the dial plate and bezel are fastened. The case proper is a thin detachable metal cup which slips on over the back of the frame. This arrangement makes the governor and indicating train very accessible and permits calibration with the dial in place.

AMERICAN CENTRIFUGAL TACHOMETER.

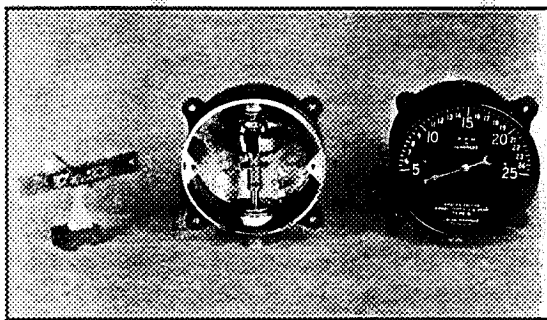

FIG. 30.—Johns—Manville.

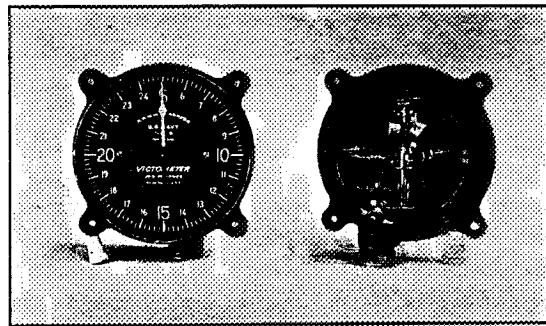

FIG. 31.—Jones.

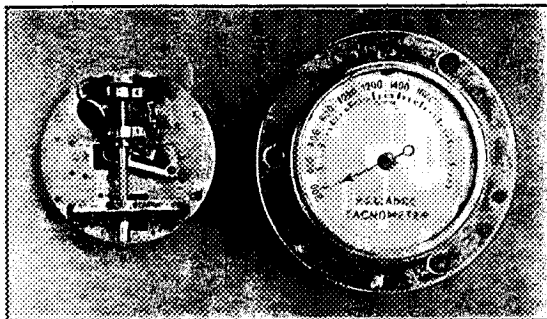

FIG. 32.—Reliance.

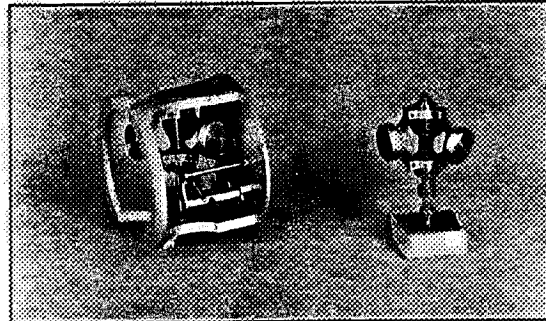

FIG. 33.—Hoffecker.

There are three weights. The spider to which the links are attached at the top is adjustable, being held by a set screw.

The indicating train is of the type shown in figure 28. The lever carrying the contact pin is, however, adjustable in length. The contact pin is of steel. The pointer is driven into a tapered staff, as in the Johns Manville.

Reliance.—This tachometer, used by the Navy, appears in figure 32. It also is of the light-weight high-speed type. The governor speed is about one and a half times indicated speed or three times cam-shaft speed. A special adapter is used on the cam shaft, there being no gears in the instrument itself.

The indicating train is also of the type shown in figure 28.

The contact pin is of hardened steel, the sliding collar being of brass. An adjustable contact pin lever and an adjustable zero stop are provided for use in calibration.

The governor bearings, indicating train, and dial are mounted on a detachable frame, so that the calibration may be done before inserting in the case with good access to the mechanism.

This instrument has not been standardized. The shaft connection as made is provided with a sliding element which a compression spring keeps in mesh with the flexible shaft. Thus also the end thrust in the flexible shaft, which may cause unsteadiness, is taken up.

The dial is white and the scale, determined separately for each instrument, extends from 200 to 2,400 revolutions per minute in intervals of 50 revolutions per minute over an angle of about 225°.

The case and mechanism are both of heavy construction.

Hoffecker.—This instrument, shown in figure 33, is very similar to the Reliance. The weight and speed of the governor are about the same as well as the means of calibration.

The frame carrying the governor and indicating train is of rigid though light construction.

A unique feature of the indicating train is that it has two contact pins of hardened steel which form the tines of a fork swiveled on the end of the usual contact pin lever. These pins bear on opposite sides of the sliding collar and are intended to eliminate fluctuations due to lack of perpendicularity of the surface of the collar to the shaft or roughness of the surface.

The instrument has not been standardized. The flexible shaft provided has a ball bearing end and a wedge-shaped tip which facilitates meshing at high speed.

The scale is graduated similarly to that of the Reliance and likewise is determined separately for each instrument.

Jones speedometer.—This instrument, shown in figure 34, is of the oblique weight type with sliding collar, the weight being in the form of a ring. The connection between the governor and the sliding collar is formed by a lug projecting from the upper end of the collar sleeve and bearing on a hardened steel pin embedded in the oblique weight. There are two helical control springs—one, a weak spring which is compressed by the collar, the other, a strong clip-like spring which is coiled up as the oblique ring deflects.

The indicating mechanism is unusual in that it contains a cam plate, the proper shaping of which gives a uniform scale.

Schaeffer and Budenberg.—Figure 35 shows the exterior of the instrument, which is of the same type as the Jones centrifugal speedometer described above. The motion of the weight is transmitted to the collar through two parallel links pinned at their ends. A unique feature is that the contact pin bears against the under surface of the sliding collar.

The instrument has three drive spindles and is fitted with a gear box, so that full scale deflection may be had for three different speeds, such as 200, 1,000, and 2,000 revolutions per minute, by using the proper spindle.

This type of instrument is suitable for tests on airplane motors.

Elliott.—This is a British instrument, also of the oblique weight type, and is shown in figure 36. The governor is in the form of a dumb-bell pivoted in a boxlike frame inserted in the governor shaft. The control spring is a helical spring fixed to the frame at one end and to the governor at the other.

The indicating mechanism is unusually simple in that the lever carrying the contact pin is fastened directly to the pointer staff. The pointer is pivoted in the lower part of the dial and the angular motion is only about 90°. The scale is graduated from 800 to 2,000 revolutions per minute in intervals of 50 revolutions per minute.

Smith.—This instrument, the mechanism of which is shown in figure 37, is also a British tachometer of the oblique weight type. The governor is a flat link-like casting. A hemispherical casting, fixed to the lower end of the shaft, supports the ends of the governor pin and also serves as a flywheel. There are two exactly similar flat coiled control springs. The connection between the oblique weight and the sliding collar is formed by a fork fixed rigidly to the collar and bearing on a hardened pin, as in the Jones speedometer above.

The indicating mechanism is of the ordinary construction, shown in figure 28. The scale is graduated from 600 to 2,000 revolutions per minute in intervals of 20 revolutions per minute and has an angular length of about 300°.

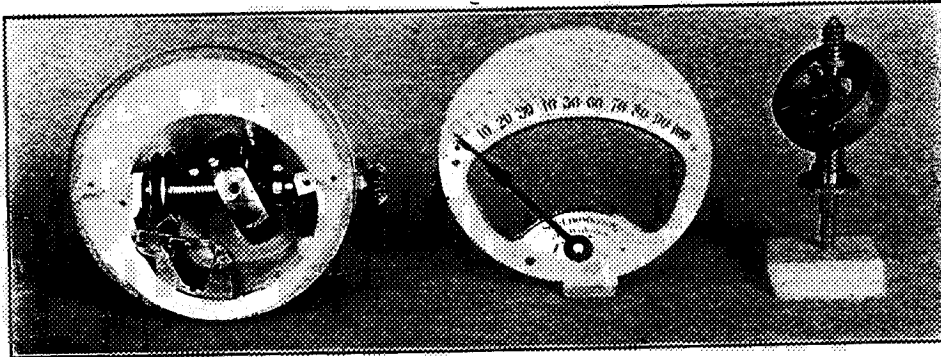

FIG. 34.—Jones Centrifugal Tachometer.

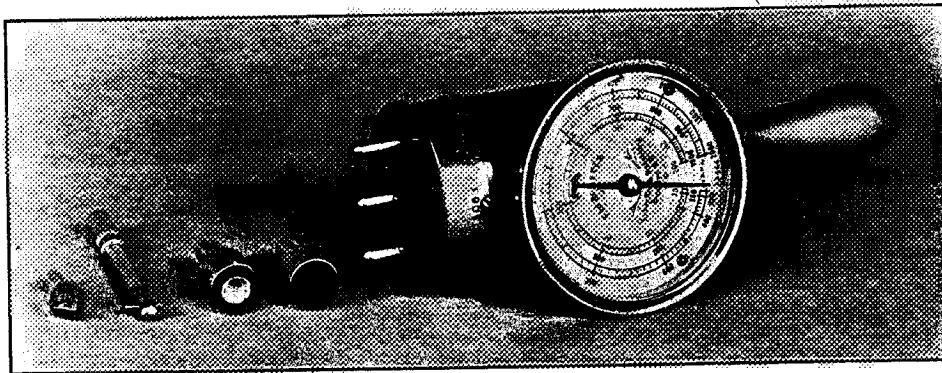

FIG. 35.—Schaefer and Budenberg.

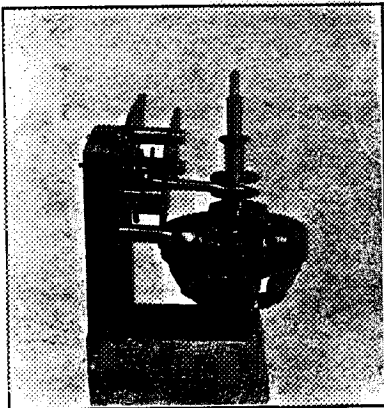

FIG. 36.—Elliott.

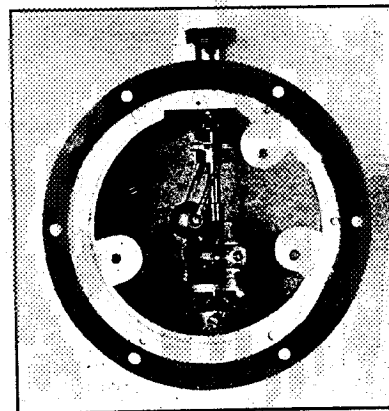

FIG. 37.—Smith.

Oliver.—This tachometer, the mechanism of which is shown in figure 38, is of the oblique weight type, but has certain peculiar features.

Uniformity of scale is obtained by means of a cam plate in the governor. This cam is attached to the oblique weight and deflects with the latter. Connection between the cam and the indicating train is made by means of a rod sliding in a boring in the shaft. The contact point with the indicating train is in the center of the rod where there is no motion and thus wear is avoided. The contact point with the cam is near the axis of rotation of the oblique weight. This tends to minimize disturbances due to a reaction of the rod on the oblique weight.

The governor control consists of two pairs of helical tension springs. The points of attachment of these springs are so placed that the lines of action of the springs pass through the axis of rotation of the oblique weight in the position of rest. As the oblique weight deflects, however, they get farther and farther away from this axis. Thus a restoring torque increasing

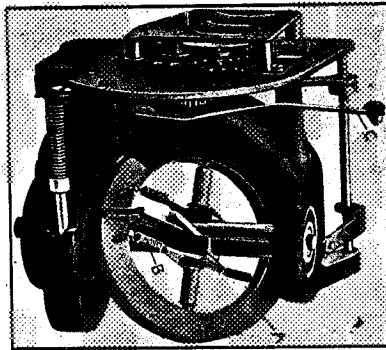

FIG. 38.—Oliver centrifugal mechanism.

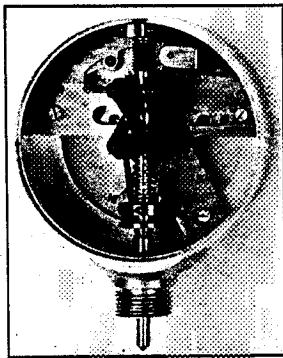

FIG. 39.—Olhovsky mechanism.

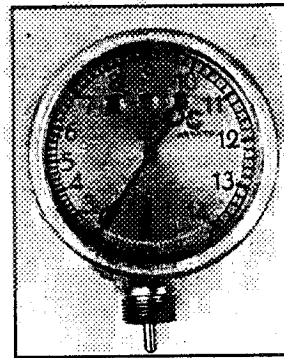

FIG. 40.—Olhovsky case.

more rapidly than the first power of deflection is obtained, which, it is claimed, facilitates the attainment of a uniform scale.

Olhovsky.—The Olhovsky tachometer shown in figures 39 and 40, is a Russian instrument of the double oblique weight type with sliding collar. The weights are in the form of rectangular frames consisting of cylindrical rods with flat connecting pieces and are in rotational balance. Each acts separately on the collar through a link. The control spring is helical and is located between the sliding collar and a ball-like shoulder on the shaft, being compressed as the collar moves upward.

A two-tined steel fork with swivel joint, similar to that in the Hoffecker described above, is used to connect the governor and indicating mechanism.

A noteworthy feature of this instrument is that it is compensated for the effect of tilting with reference to the vertical and also for the effect of external shocks. This is accomplished

by unbalancing the governor weights by an amount equal to one-half of the combined weight of the collar and floating pin and by pivoting the rollers at a distance from the centers of rotation of the weights equal to that of their centers of gravity. Thus the movement of the weights about their pivots, due either to gravity or sudden acceleration in any direction, is just counter-balanced by that of the collar and pin.

The indicating mechanism is novel. A nut with a hardened steel point bears on the float mentioned above. Longitudinal motion of this nut causes the threaded pointer spindle, which is screwed into it, to rotate. A coiled spring on the pointer staff serves as a control spring for the governor as well as to take up backlash.

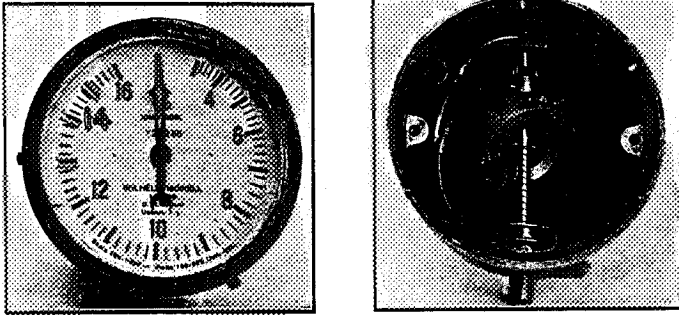

FIG. 41.—Morell "Phylax."

The instrument is very compact, the whole mechanism being contained in a cylindrical case $2\frac{1}{4}$ inches diameter by 2 inches high.

Morell "Phylax."—This instrument, a single oblique ring type of German design, is shown in figure 41. It is of the usual link and sliding collar construction. As in the Jones speedometer there are two

control springs, one compressed by the collar and the other a clip-like spring between the governor and the shaft.

The indicating train is unique in that it contains a spring which serves to take up sudden shocks or changes in speed. It is also provided with an air damping device consisting of a small vane geared up so as to make many revolutions for one of the pointer pinion.

Oil tubes are provided running from a well in the top of the case to the shaft bearings and to the steel pin which bears on the collar.

Jacquet.—This tachometer, the exterior of which is shown in figure 42, is a hand tachometer of the oblique weight type with a single coiled control spring contained in a slot in the governor shaft. A small steel plunger sliding in a boring in the shaft is connected with the oblique weight by a link passing through a slot in the side of the shaft. Connection with the indicating train is through a ball-and-socket joint in the end of the plunger. The indicating train is of the ordinary sector and pinion type.

The instrument has only a single spindle, although it provides for three ranges of speed. Change of gears is effected by moving the button seen in the neck of the instrument.

Horn.—This is a German double oblique weight type. The governor is similar to that of the Olhovsky and the indicating train the same as in the Jacquet. Likewise it is a single spindle hand instrument.

Standard.—In this tachometer two weights, sliding on pins fixed at right angles to the shaft, fly out when the system is rotated. Their sides each bear against pins on pivoted sectors which mesh with a circular sleeve rack sliding on the governor shaft. As the weights move outward the sectors are rotated and the sleeve raised. A pinion geared to the pointer staff also meshes with the lower part of this circular rack, the motion of which is thus communicated to the pointer.

The governor control is by means of two helical springs, which are put in tension by the rotation of the sector about its pivot.

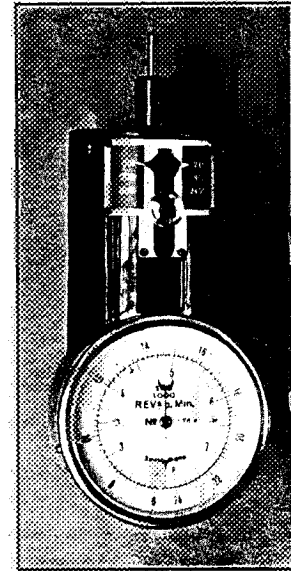

FIG. 42.—Jacquet.

Loring.—The Loring instrument is a modification of the double oblique weight type. The governor consists of two light weights pivoted outside the shaft in a relatively heavy casting. Rollers on the inner ends of these weights run in slots in the sliding collar, so that as the weights turn the collar is moved. A steel pin driven into the collar slides in the shaft, which is hollow and slotted. On this pin rests a floating hardened steel pin which is raised or lowered with the collar.

Calibration is accomplished by moving the upper collar, adjusting the length of the contact pin arm and bending the control spring.

The scale is graduated uniformly from 500 to 2,500 revolutions per minute in intervals of 20 revolutions per minute and extends over a complete circumference.

The instrument weighs only 14 ounces complete.

AIR DRAG OR VISCOSITY TACHOMETERS.

Waltham.—The Waltham tachometer shown in figure 43 is of the air viscosity type described in principle above. There are two concentric cylinders, geared to the main drive, of which the outer one only is shown in the right-hand view. Between them, and separated from them by a thin air film, is placed the inverted cuplike cylinder, mounted in jeweled bearings, to which the pointer is fixed.

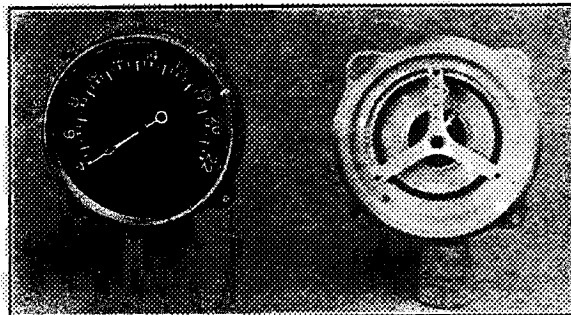

FIG. 43.—Waltham air viscosity tachometer.

The dial is graduated to show speeds from 400 to 2,200 revolutions per minute, the deflection of the pointer for this speed range being about 240 degrees.

AIR PUMP OR AIR LEAK TACHOMETERS.

Van Sicklen speedometer.—This instrument, shown in figure 44, is typical of the air pump or air leak tachometer mechanism. The lower right-hand view shows the centrifugal air pump and the admission port; the lower left-hand view the discharge orifice and air chamber. Special attention is called to the variable width groove through which the air leaks beneath the vane which is shown with the indicating drum in the upper right-hand view. The width of this orifice is made such that a deflection of the vane is obtained proportional to the driving speed. The upper left-hand view shows the assembled mechanism.

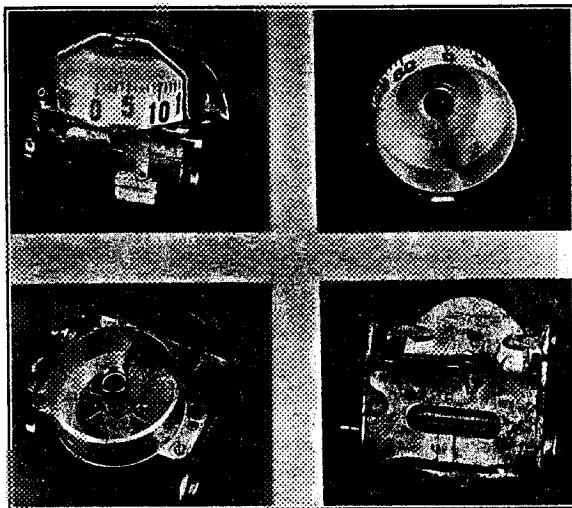

FIG. 44.—Van Sicklen air pump speedometer.

MAGNETO OR ELECTRIC TACHOMETERS.

Tetco.—Figure 45 shows the Tetco electric tachometer. The magneto is of the ordinary bi-polar construction with a single permanent horseshoe magnet. The indicator consists of a suitable range millivolt-meter calibrated to read speeds from 0 to 2,000 revolutions per minute in intervals of 20 revolutions per minute.

MAGNETIC TACHOMETERS.

Warner.—Figure 46 shows a cartridge type of magnetic instrument. The permanent magnet, running in ball bearings, is in the form of a split ring. The drum, in which currents are induced, is held a definite distance from the top of the magnet. The leakage field of the magnet is utilized; consequently the magnet is comparatively strong for a given torque on the disk.

A device for compensating for the effect of temperature consists of an iron ring mounted on three bimetallic levers. Changes in temperature cause this ring to move nearer or away from the magnet, thus distorting the magnetic field and changing, by a suitable amount, the strength of the field utilized for torque.

Reproduced from
best available copy.

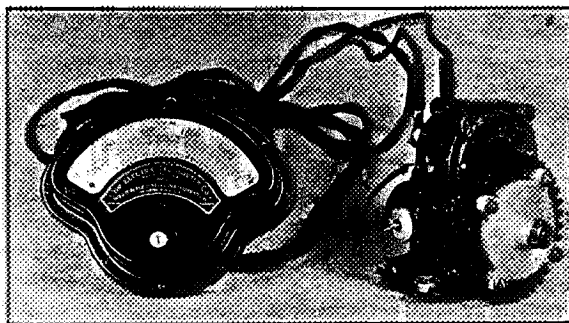

FIG. 45.—Tetco electric tachometer.

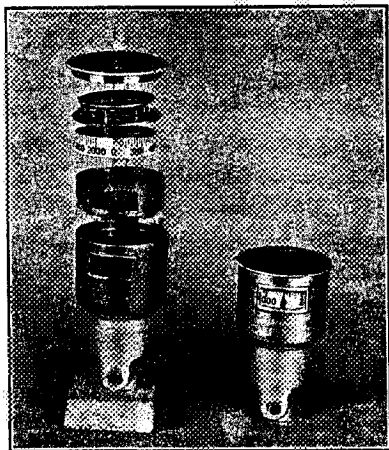

FIG. 46.—Warner magnetic tachometer, cartridge type.

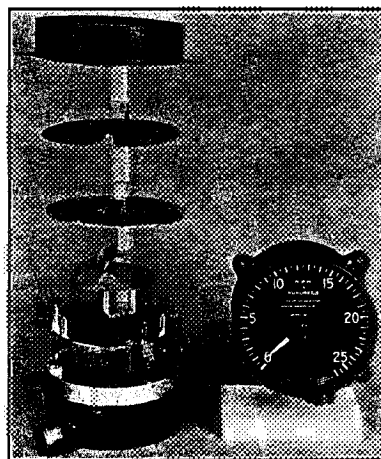

FIG. 47.—Warner magnetic tachometer, airplane type.

The instrument is calibrated by moving the magnet nearer to or away from the indicating disk.

The scale, which is on the side of the drum, is graduated from 0 to 2,000 revolutions per minute in intervals of 25 revolutions per minute.

Figure 47 shows an airplane model of the same instrument. The magnet is geared to the main drive. A disk with pointer attached is used instead of a drum.

The same type of temperature compensator is used as in the cartridge model. It is not shown in the figure.

Attention is called to the pointer damping device which consists merely of a permanent magnet placed near and over the edge of the indicating disk.

The scale extends from 0 to 2,600 revolutions per minute in intervals of 50 revolutions per minute.

Deuta.—Figure 48 shows a cartridge type of German make. The permanent magnet, running in ball bearings, is in the form of a split ring. The inverted drum, in which currents are induced, is mounted in jeweled bearings coaxially with the magnet. Calibration is effected by adjusting the position of a truncated cylinder and thus varying the strength of the magnetic field.

The instrument has no temperature compensator.

The scale extends from 0 to 1,600 revolutions per minute over about 300° and is non-luminous.

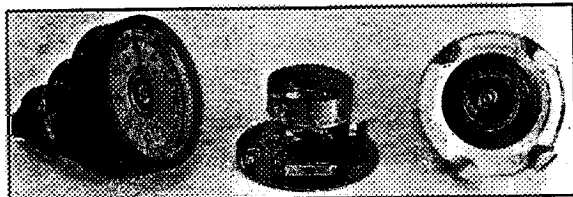

FIG. 48.—Deuta magnetic tachometer.

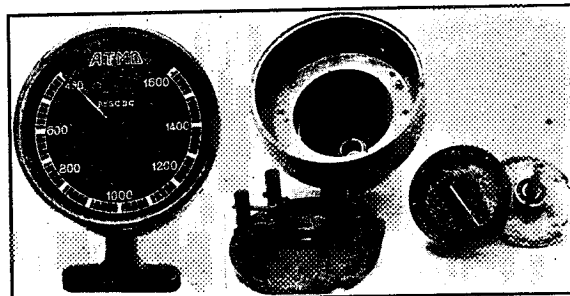

FIG. 49.—Atmo mercury viscosity tachometer.

MERCURY VISCOSITY TACHOMETERS.

Atmo.—This tachometer, shown in figure 49, is a French instrument of the mercury viscosity type. Mercury contained in a steel cylinder is rotated and tends to drag with it a disk fixed to the pointer staff and mounted concentrically with the cylinder. The deflection of the pointer is controlled by two flat coiled springs, one of which comes into action later than the other, thus tending to make the scale more nearly linear than if only one spring were used. The tachometer dial reads from 400 to 1,600 revolutions per minute, and is nonluminous. The weight of the instrument is approximately 3 pounds.

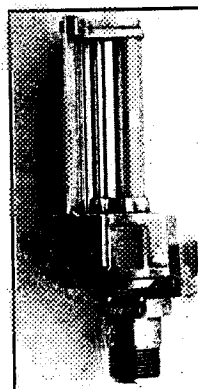
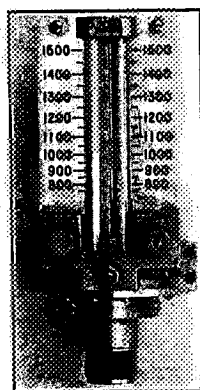

FIG. 50.—Veeder liquid centrifugal tachometer.

LIQUID CENTRIFUGAL TACHOMETERS.

Veeder.—This tachometer, shown in figure 50, is an American instrument of the liquid centrifugal type adapted for airplane use. A paddle wheel rotates in a liquid and forces it through a throttle valve up a system of glass tubes. The height of the liquid indicates the speed. The scale extends from 750 to 1,500 revolutions per minute. The weight of the instrument is approximately 1¾ pounds.

REPORT No. 129.

POWER PLANT INSTRUMENTS.

PART II.

TESTING OF AIRPLANE TACHOMETERS.

By R. C. SYLVANDER.

SUMMARY.

This part describes in detail the apparatus and methods of testing airplane tachometers at the United States Bureau of Standards. Also, the average results of tests on many instruments of the chronometric, centrifugal, magnetic, and air viscosity type are given and are discussed.

INTRODUCTION.

The principal tests made on airplane tachometers are for calibration error, lag, effect of reversing the direction of rotation of the drive shaft, and the effect of various conditions encountered in airplane flights, such as change of temperature, vibration, continued running, tilting, and reduced air pressure. The usual method of determining the error or effect is to compare the reading of the tachometer with that of a master instrument driven from the same shaft. In the following the apparatus and methods for the various tests, as well as the procedure in calibrating the master tachometer itself, are described.

DESCRIPTION OF TESTING APPARATUS.

DRIVING APPARATUS.

The driving apparatus, shown in figure 1, consists of a one-fourth horsepower, direct-current shunt motor (M) and a 14-inch flywheel (O) mounted on a base plate. (M) and (O) run in separate bearings, but the Oldham connection (U) makes perfect alignment between them unnecessary.

Variation in speed is obtained by means of the rheostat (R), which can be connected in series with either the armature or the field of the motor by means of the switch (A). By removing the resistance from the armature circuit and then, after reversing the switch, inserting it in the field circuit, a gradual increase in speed is obtained from zero to 3,000 revolutions per minute. In lowering the speed the operations are reversed.

By this method of varying the speed, power is wasted in heating and the rotation tends to be unsteady at high and low speeds. The latter objection is practically overcome by the flywheel, which, at the same time, allows the speed to be varied with sufficient rapidity from point to point. The method has the advantage that the drive is direct without possibility of slippage.

Fine speed regulation is obtained by friction of the hand on the rim of the flywheel, using the master tachometer (T), figure 1, as an indicator. Special tests have shown that, with proper precautions, the speed may thus be held constant within a few revolutions per minute for tests either on instruments or on the master itself.

MULTIPLE CONNECTION STANDS.

Four forms of multiple drive for connecting instruments to the driving apparatus are used. The connections are designed from the standard instrument, flexible shaft, and engine connections used on American airplanes during the war and shown in sketch No. 75 issued October 11, 1917, by the United States Signal Corps.

The first of these (V) (fig. 2) consists of a series of five right-angle joints connected in series and fitted with vertical extensions of one-fourth inch extra-heavy pipe, approximately 6 inches and 1 foot long, to which the instruments are attached in staggered arrangement by means of standard couplings. The pipe extensions serve both as casings for the flexible cables by which the instruments are driven from the right-angle joints and as rigid supports for the instruments themselves. This form of multiple connection gives good results with centrifugal tachometers, which are frequently unsteady with a rigid drive.

The unit is attached either directly to the shaft of the flywheel by means of an Oldham coupling, as in figure 2, or to one of the sockets of the double drive (X) (fig. 1), either by an Oldham coupling or a flexible shaft, as the stand (Y), figure 1.

(W) (fig. 2) is a form of multiple drive, very similar to (V) (fig. 2). The right-angle joints in this case are the same as those of (V) except that they are made with the standard engine

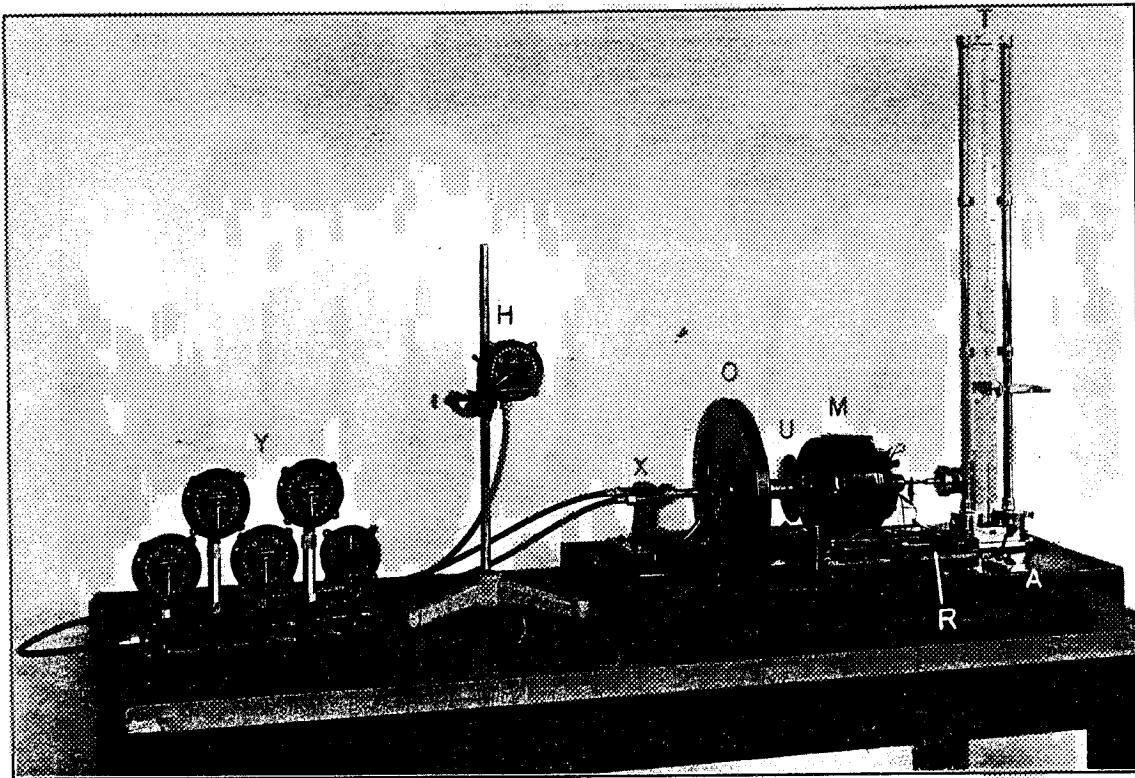

FIG. 1.—Testing apparatus for airplane tachometers.

camshaft connection, so that instruments can be driven from them by means of the regular flexible shaft. This also works well with centrifugals, but requires a separate support for the instruments.

A two-way drive of this kind is (X), shown in figure 1, attached to the driving apparatus. This is used to drive instruments individually, as (H), figure 1, or one or two of the five-way stands, as (Y), figure 1.

(Y) is a rigid multiple drive. The right-angle joints are the same as those of (V), but the instruments are connected rigidly to them—three directly, the other two by means of rods contained in pipe extensions to which the instruments are attached. The right-angle joints are provided, on the ends from which the instruments are driven, with universal tips, giving lateral play, the same as in the regular flexible shaft. Nevertheless this form of drive is apt to cause unsteadiness in the case of centrifugal tachometers, especially in the case of the instruments farthest from the driving end.

MASTER TACHOMETER.

The master tachometer (T), figure 1, is connected to the motor shaft by a rigid drive, so that its running speed is equal to that of the instruments. A comparison of the readings of the two, corrected for the errors of the master itself, thus gives the errors of the instruments.

The master tachometer used at present is a 36-inch Veeder, Form H-4, liquid centrifugal tachometer. This instrument contains colored kerosene and has a paddle wheel in the base which, as it rotates, drives the liquid up in a vertical glass tube. The speed is determined by the position of the meniscus on a scale graduated in revolutions per minute.

The instrument has a very open scale, is direct reading, sensitive, and quick in operation. Investigations made thus far indicate that the secular changes and the errors due to lag, tem-

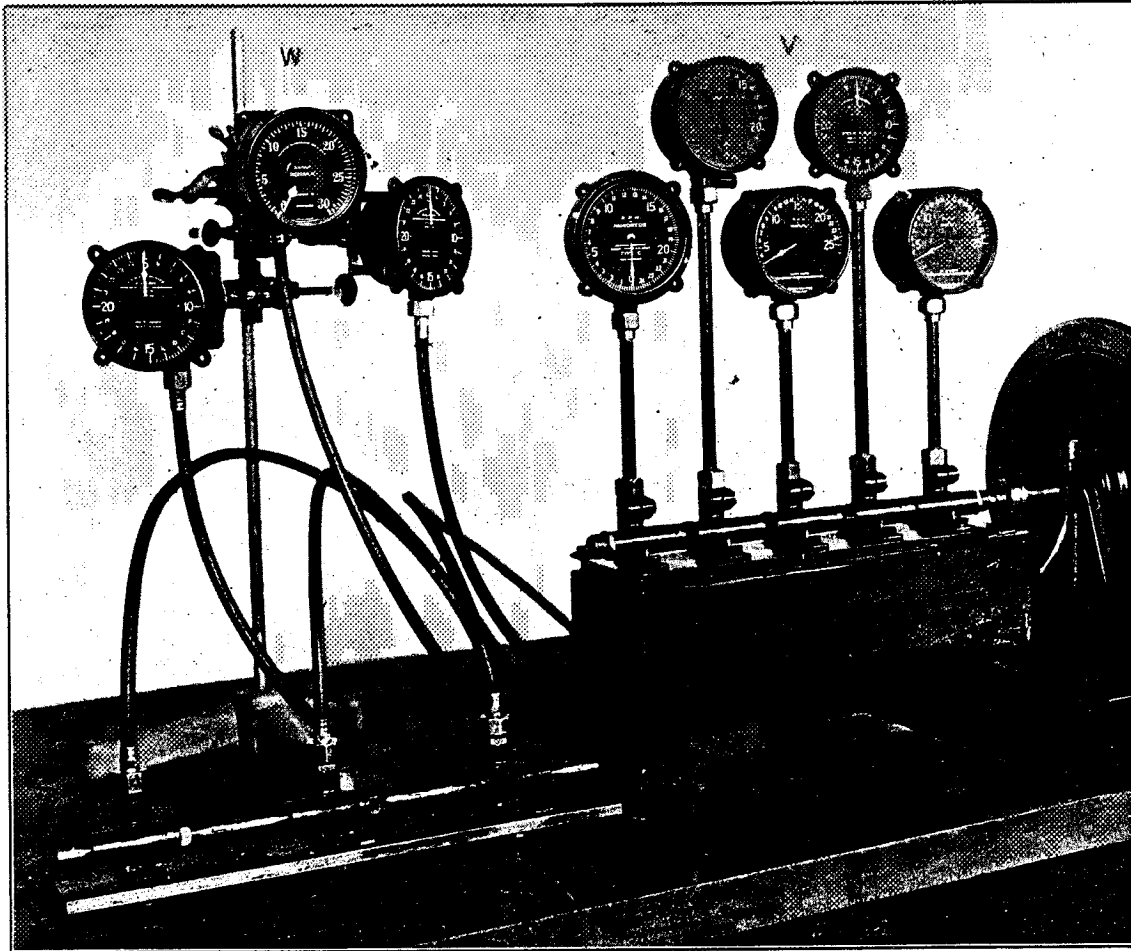

FIG. 2.—Multiple connection stands.

perature, leakage, and inaccuracy in the setting of the zero, though not negligible, are of no serious consequence in the testing of airplane tachometers, which are read ordinarily to five revolutions per minute only.

OTHER APPARATUS.

Another method of testing tachometers is by means of a Tinsley stroboscopic apparatus. A so-called observation disk, on which are certain regular geometric designs, is rotated at the same speed as the tachometer and is illuminated 50 times a second by the instantaneous action of a Neon tube. The lighting of this tube is effected by means of a tuning fork which, as it vibrates, makes and breaks the primary circuit of an induction coil in series with a 2-volt battery. The secondary of the induction coil then gives a discharge through the Neon tube.

It is seen that when the rate of illumination of the tube synchronizes with the sides of any figure on the rotating observation disk that figure will appear to be stationary. If the figure appears to slowly rotate backward, the rotating machine is slow of the tuning fork, and fast when it appears to rotate forward, being exactly at the initial speed when the figure is stationary. Standard speeds are easily picked out by reference to a table.

TESTING METHODS.

DETERMINATION OF CALIBRATION ERROR.

The procedure in determining the calibration error differs somewhat, according to the presence or absence of lag and whether the tachometer is continuously recording, like the centrifugals, or discontinuous in its action, like the chronometrics.

By lag is meant the failure of a tachometer to respond immediately to changes in speed, so that readings taken during or after an increase in the speed are too low; those taken at the time of or subsequent to a decrease in speed too high.

WHEN LAG IS ABSENT.

If lag is known to be absent or negligible, as in the Van Sicklen chronometric and most electric tachometers, the calibration error is determined as follows: One observer holds the reading of the master constant at the speed at which the error is desired. Another observer simultaneously takes a number of readings of the tachometer. The average of these readings minus the fixed reading of the master, the latter corrected for its own error, gives the error of the instrument in revolutions per minute. If the tachometer is a chronometric, it is well to have the readings cover several counting periods, the latter being usually one or two seconds in length. In this way the effect of the fluctuations, which occur under certain conditions even at constant speed in this type of instrument, may be partially eliminated.

WHEN LAG IS PRESENT.

If the instrument has lag, failure to take account of the same may lead to serious inaccuracy. This is because the lag lasts sometimes several minutes after a variation in speed, even when the instrument is tapped or vibrated, so that the observed error is not the true calibration error but the resultant of it and the lag.

In this case the errors with increasing and decreasing speed are observed and their algebraic mean taken as the true calibration error. Thus the effect of the lag, not only of the tachometer but of the master instrument as well, is eliminated. The procedure varies somewhat, according to the type of instrument.

If the tachometer is of the discontinuously recording chronometric type, like the TEL, in which case the lag is caused by lost motion alone, the speed is brought slowly up to, but not beyond, the point at which the error is to be determined and the error noted. The speed is then lowered 50 to 100 revolutions per minute, brought up again, and another reading taken. A few readings are made in this way and an equal number in the same manner, except that the point in question is approached from a higher instead of a lower speed. The algebraic average of these errors is the calibration error of the instrument. The procedure is similar to that employed in the case of screws and other apparatus subject to lost motion.

On the other hand, if the tachometer is of the continuously indicating type, such as the centrifugals, air viscosity tachometers, and magnetics, the speed is raised continuously from the lowest to the highest point of the scale and then lowered again continuously at the rate of about 50 revolutions per minute in 10 seconds. The throttle of the Veeder is kept open in this test by about five turns of the throttling screw, to minimize the lag in the master itself. One observer varies the speed and watches the master, signaling quickly, as the meniscus passes the respective points on the scale, to another observer, who records the error of the tachometer.

Usually a check run is made. In any case an equal number of readings with increasing and decreasing speed are taken at each point. The errors with increasing speed, or "up errors," are recorded in a column opposite the corresponding speed and the errors with decreasing speed,

or "down errors," in a parallel column. With a view to the later calculation of the lag, the up errors at each point are averaged by themselves, and likewise the down errors. The algebraic mean of the two averages gives the calibration error at the point. The values are tabulated in a third column parallel with the columns of up and down errors.

LAG.

The lag is measured numerically by the algebraic excess of the down over the up error or reading. It depends frequently on the rate of variation of the speed and on other conditions, such as vibration, and, in liquid tachometers, on the degree of throttling.

In all measurements of lag care should be taken that the lag of the master tachometer itself is negligible; otherwise the observed values will be too low. The use as a master of a tachometer of the same type as the one under test or of a type, such as the centrifugal, commonly known to be subject to lag, is especially open to question. The lag of the Veeder instrument, with the precautions as to throttling and rate of variation of speed noted above, is five revolutions per minute or less.

The lag is calculated by taking the algebraic difference of the average of the up and down readings already found. The values are recorded in a fourth column parallel with the three error columns. It is customary to omit the sign.

EFFECT OF REVERSAL.

For use in multiple-engined planes where some motors run clockwise and others counterclockwise it is necessary that the tachometer should read the same for either direction of rotation of its drive shaft. A comparison of the calibrations for both directions of drive gives this effect.

EFFECT OF VIBRATION.

Airplane instruments are always subject to more or less vibration from the engine. This, on the one hand, facilitates the movement of the parts and thus reduces the lag. On the other hand, it tends to cause unsteadiness of the pointer, looseness, and wear. The latter effects will be treated in another paragraph.

To test the effect of vibration on the lag, tachometers are mounted on a special table, as shown in figure 3. The vibration is produced by means of an unbalanced weight (W), fastened to the shaft of a small motor (M), screwed to the under side of the table. The lamps (H) regulate the speed of the motor and hence the frequency of the vibration. The legs of the table are provided with rubber tips and fit into holes in the baseboard to keep them in place. In this test the instruments are usually driven by flexible shafts, as in figure 3.

EFFECT OF TIPPING AND ACCELERATION.

Some types of tachometers, for example, the centrifugal, show an error when inclined to the vertical and also when subjected to linear acceleration, as in banking, climbing, and acrobatic flying. For this reason tests are ordinarily made with the instrument in the normal vertical position.

Tipping and acceleration produce the same effect; namely, a change in the effective force of gravity. For example, tipping an instrument upside down is the same as giving it a downward acceleration equal to twice that of free fall. Therefore the acceleration test is omitted and the tipping error taken as a measure of the acceleration effect.

The tipping error is determined by simply tilting the instrument on a ring stand or pivoted board and comparing the error in the inclined position with that in the vertical position.

EFFECT OF TEMPERATURE.

The changes in temperature which occur in airplane flights affect the reading of some types of tachometers. Determinations of the error from this cause are made by means of the thermally insulated chamber shown in figure 4. The walls of this chamber, including the

door which forms the front side, are composed of 4 inches of cork board faced with wood. Lateral windows, consisting of two sheets of plate glass separated by an air space and covered by doors having 1 inch of cork board, give visual access to the chamber. The tachometers are mounted in front of the windows either on the multiple connection stands previously described or on detachable instrument boards fastened to the wall of the chamber. The rigid or flexible connections with the driving apparatus pass through a hole in the wall or door of the chamber. In the case of the instrument boards the tachometers are held in place simply by pins and wooden buttons to facilitate attachment and removal.

Tests are made in the neighborhood of $+40^{\circ}$ C. and -10° C., a range of 50° C., or about the maximum encountered in airplane flights. The higher temperature is produced by the

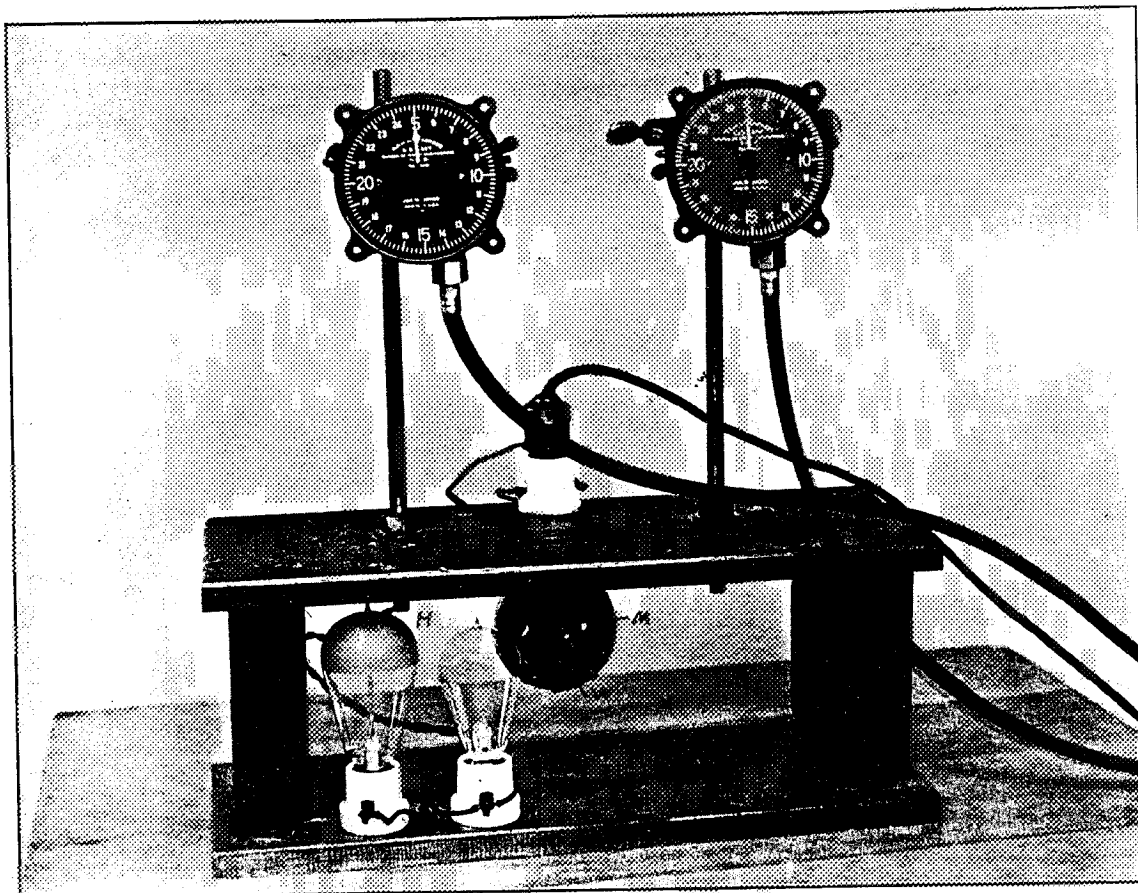

FIG. 3.—Apparatus used in vibration tests.

electric heater shown in figure 4, the lower temperature by brine circulating in the radiator. A fan insures reasonable uniformity of temperature throughout the chamber.

The procedure in determining the error is exactly the same as at room temperature. A comparison of the errors with those at room temperature gives the temperature effect. It is customary to state, for each speed, the maximum effect observed; that is, the greatest difference (algebraic) between the "hot," "cold," and room temperature errors. It is well to note also the effect on the lag, which may be considerable, due possibly to differential expansion or thickening of lubricant.

ENDURANCE AND VIBRATION

The endurance tests and the test for the effect of long-continued vibration are performed simultaneously, partly to save time, partly to reproduce actual conditions as closely as possible. The apparatus used, shown in figure 5, is contained in a double wooden box to deaden the noise.

The outside of the inner box and the inside of the outer one, as well as the corresponding doors, are completely covered with 1 inch of hair felt, and, in addition, there is an air space of about 1 inch between the boxes on all sides. The outer box is approximately 2 by $2\frac{1}{2}$ by $7\frac{1}{2}$ feet.

The instruments are mounted on multiple connection stands, usually of type (Y), clamped to a table similar to that shown in figure 3 and also having attached to its under side a small eccentrically loaded motor which keeps it and the instruments in constant vibration. Motive power is furnished by one-eighth to one-fourth horsepower motors placed at the ends of the

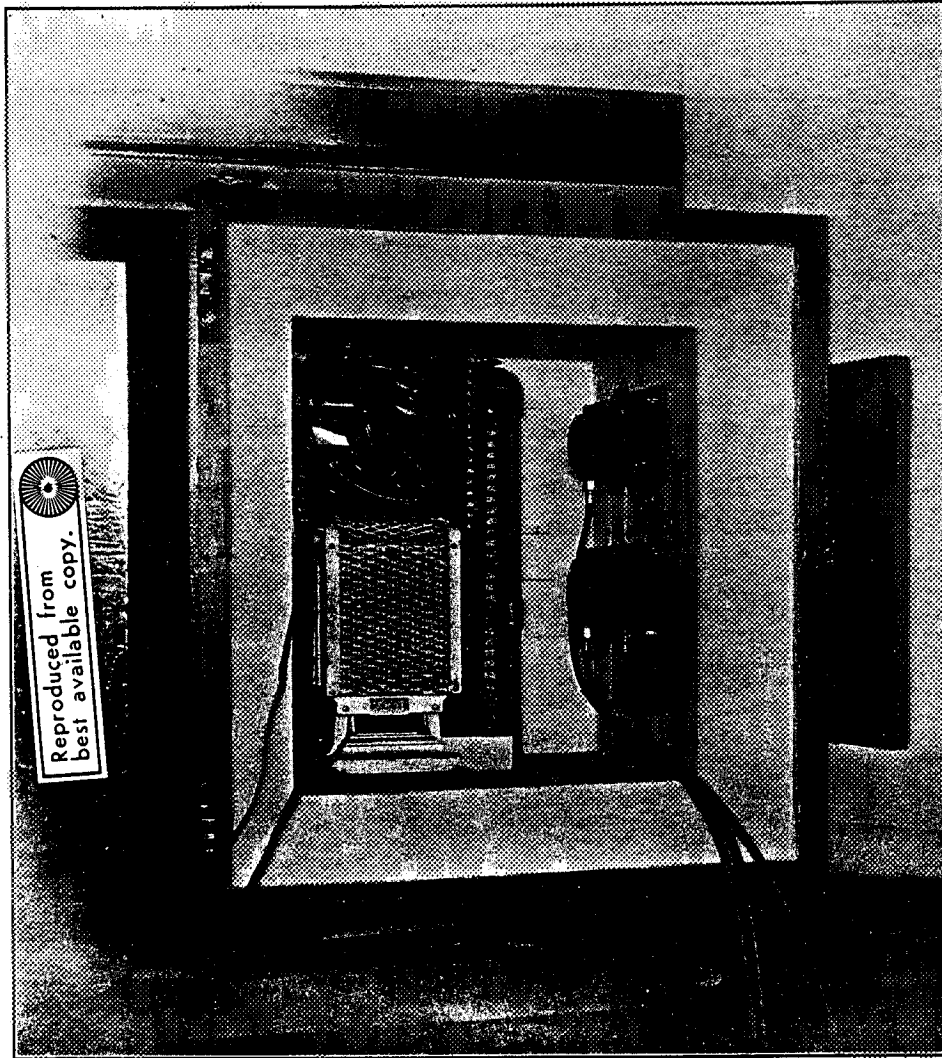

FIG. 4.—Temperature chamber.

table. Connection between the motors and the multiple drives is made through a friction pulley, which allows slippage and thus prevents serious injury to the multiple drive or instruments in case of stoppage; and, also, through a universal joint which gives the flexibility required from the fact that the multiple drive is vibrating, whereas the motor is fixed. An automatic cutout disconnects the motor, in case of stoppage or serious reduction in speed, to prevent burning out of the same, and also stops a clock so as to record the time.

Two different arrangements appear in figure 5. One connected with the left-hand motor, consists of a small horizontal centrifugal governor which collapses as the speed diminishes,

opening a contact gap in the motor circuit and pushing a plunger up against the balance wheel of the clock.

The other, connected by a flexible shaft with one of the multiple drives, is seen in the upper left-hand corner of the chamber. A small fan, driven through the flexible shaft, blows air against a light aluminum wind cup pivoted in horizontal bearings. Above a certain speed the wind cup is held over away from the fan maintaining the connection with the motor (right hand). Below the speed the wind cup, being suitably unbalanced, drops back toward the fan, breaking the motor connection, but making connection between a battery and the electromagnet seen directly back of the right-hand clock. The magnet, being excited, releases a plunger which springs up against the balance wheel of the clock, at the same time again breaking the connection with the battery in order not to exhaust the latter.

Neither of the cut-outs described will function in the case of stoppage of individual instruments, unless accompanied by stoppage or considerable slowing down of the entire apparatus.

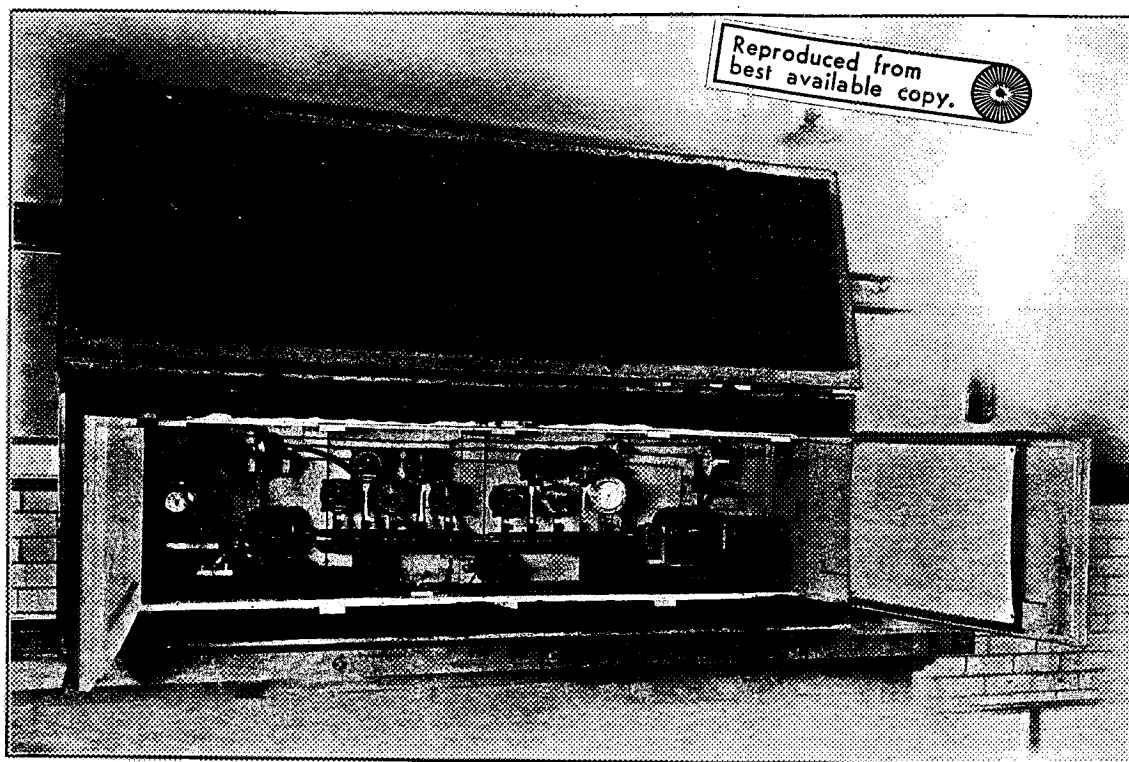

FIG. 5.—Endurance—vibration apparatus.

When this occurs, however, they serve the double purpose of protecting the motor and of recording the time, so that the duration of the run may be known.

The normal length of run is 150 hours. After the run the instruments, which have suffered no breakdown or serious mechanical defect, are recalibrated and the change in calibration at each point as a result of the run tabulated. All instruments are then dismantled and examined for wear, looseness, slippage, lubrication difficulties, or other mechanical troubles.

EFFECT OF REDUCED AIR PRESSURE.

Some tachometers, requiring air for their action, are tested for the effect of the diminution in air pressure above the surface of the earth.

The tachometer is driven inside a partially evacuated chamber through a mercury seal. The use of a packed bearing and the temperature changes, when the driving motor itself is placed within the chamber, are thus avoided. Figure 6 shows the apparatus.

(A), (B), (C), and (D), (fig. 6), are, respectively, the drive motor, master tachometer, mercury seal, and vacuum chamber. The chamber consists of a glass bell jar (E) inverted on a steel plate (F). The plate and jar are held together partly by the weight of the latter and partly after evacuation, by the pressure of the outer air. The joint between them is hermetically sealed by the rubber gasket (K), which is cemented to the edge of the jar with shellac, the surface of the plate beneath being smeared with vaseline. The tachometer (T) is supported on a stand (J) fastened to (F).

The mercury seal (C) is of peculiar construction. It consists of a heavy walled glass manometer tube about 30 inches high. The tube is connected at one end with the air chamber through the packed coupling (G). The other end is open to the air. A standard flexible cable and casing, the latter perforated at several points, are placed in the manometer tube. Connection is made at (H) with the motor shaft, at (L) with the tachometer. The tube is

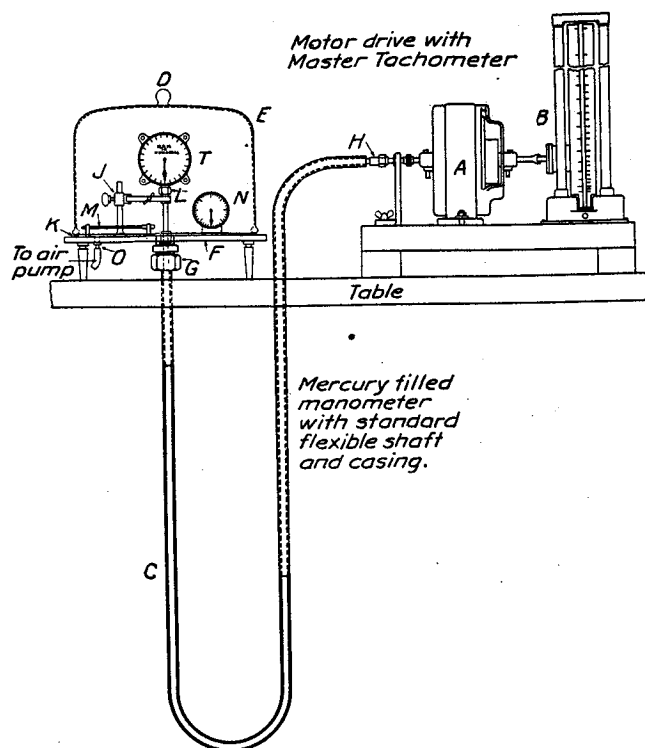

FIG. 6.—Apparatus for testing tachometers under reduced pressure.

The apparatus has been used at speeds up to 2,500 revolutions per minute and at pressures as low as one-half atmosphere, corresponding to an altitude of 20,000 feet.

CALIBRATION OF MASTER TACHOMETER.

Calibration and investigation of the master tachometer itself are done by an absolute method, by which the revolutions and the time are measured directly. Two different appliances are in use, both of the kind in which a revolution counter is operated automatically by means of electric time signals.

The first is a slight modification of an apparatus employed by the Veeder Manufacturing Co., and described by Amasa Trowbridge on pages 1221-1223 of the Transactions of an American Society of Mechanical Engineers for 1908.

partly filled with mercury. Air is exhausted from (D) through the pump connection (O). As this is done mercury arises in one arm of (C) and falls in the other, as in an ordinary manometer, until the difference in pressure in the chamber and the outer air is counterbalanced. Mercury at the same time runs in around the cable through the perforations in the casing, forming an air-tight seal about the cable without sensibly impeding its rotation. A thermometer (M) and an aneroid barometer (N) show, respectively, the temperature and pressure in the chamber.

A comparison is made of the calibration error at low pressures with that at normal atmospheric pressure. This may be determined at different speeds for the same pressure or for different pressures at the same speed. Or the pressure effect may be observed directly by holding the speed constant and either exhausting or readmitting the air to the chamber and noticing the change in reading.

It consists, in brief, of a relay, electromagnets, battery, and switches. The time signal current is passed through the relay, which, in turn, operates the electromagnets, and these throw the counter into and out of connection with the shaft whose speed is to be determined.

A possible advantage over some apparatus of this kind consists in the fact that the counter is engaged and disengaged by identical operations. Any error, due to a difference in the lag of the counter behind the time signal on connecting and that on disconnecting, is thus avoided. The electromagnets are arranged so as to give directly, without the use of links or pivoted joints, the necessary rectilinear motion for engaging and disengaging the counter.

Figures 7 and 8 show the apparatus. The wiring diagram (fig. 8) shows that the push buttons (P_1) and (P_2) are in series with the contact gap (A) of the relay, the battery (B) and

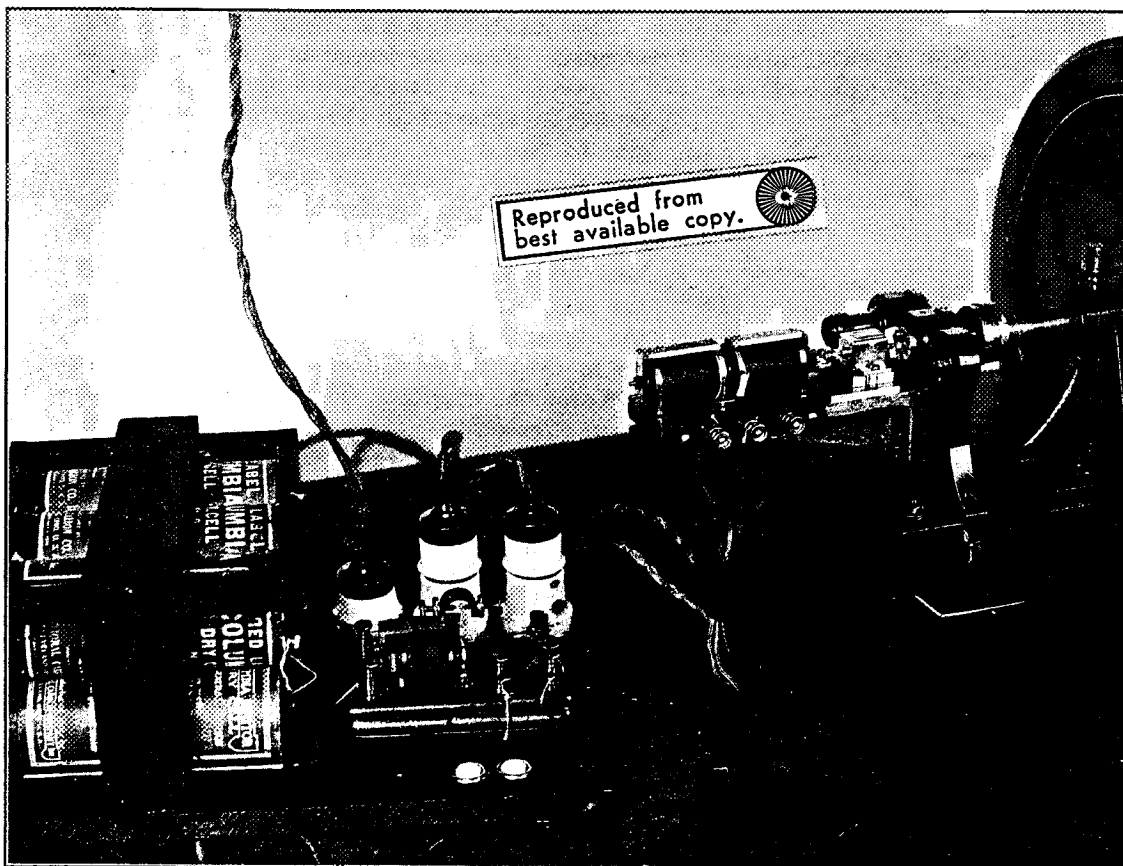

FIG. 7.—Time signal apparatus for calibrating master tachometer.

the electromagnets (M_1) and (M_2), respectively, through the connection sockets (S_1) and (S_2). Therefore, if either of the push buttons is held down, the corresponding electromagnet is actuated by the time signals. Now the magnets and counter (C) are coaxial and, by their attraction of the steel armatures (D_1) and (D_2), move the vane (L) which slides endwise in a slit in the end of the counter spindle and with which the spindle rotates. The movement of (L) is accomplished through the rod (E), which slides in holes in the cores of the magnets and to which (D_1) and (D_2) are fixed, the slip connection (G) and the rod (K), which is free to slide in a hole in the counter spindle and to which (L) is fastened. The end plates (R_1) and (R_2) are of brass. The plates (W_1) and (W_2), however, are of steel, and form, with the cores of the magnets, the return bars (H_1) and (H_2) and the base plate (T), also of steel, the partial magnetic circuits which are completed by (D_1) and (D_2). (Y) is a guiding pin to prevent rotation of (E), (D_1), and (D_2).

According as (M_1) or (M_2) is excited, (L) is thrown into mesh with the rotating clutch (N) on the end of the shaft (F) whose speed is to be determined or with the stationary clutch (O). It is held in either position by residual magnetism. Furthermore, the width of (L) is made slightly less than, but as nearly as possible equal to, the distance between (N) and (O), so that (L) goes into mesh with the one as soon as possible after going out of mesh with the other, but can not be in mesh with both clutches simultaneously.

The above form of revolution counter has the advantage that it may be connected and disconnected without moving the counter as a whole.

Suppose that, to start with, both push buttons (P_1) and (P_2) are up and that (D_2) is against (M_2). (L) is then out of connection with (F) and the counter is at rest. The reading of the counter is taken to a fraction of a revolution corresponding to the number of segments or pockets into which the clutches (N) and (O) are divided. Then just before a given signal the button (P_1) is pushed and held until after the passage of the signal. From the foregoing it follows that at the instant at which the signal is received, (M_1) is actuated, (D_1) is attracted up to (M_1), (L) is

thrown into mesh with (N), and the counter begins to record the revolutions of (F). (P_1) is now released. Next, just previous to another stated time signal, preferably an even number of minutes after the first, (P_2) is pressed and held until after the signal occurs. Obviously the effect will now be, at the instant at which the signal arrives, to excite (M_2), throw (L) out of mesh with (N), and stop the counter. This stoppage is immediate, "coasting" of the counter being prevented by the mesh of (L) with (O). The counter is then read again. The difference between the initial and final readings gives the revolutions during the interval between the time signals, and hence the speed of (F).

The time signals at the Bureau of Standards occur every second, the minutes being recognized by the omission of the fifty-ninth signal in each minute. The operation of the apparatus and the regulation of the speed are easily performed by a single observer. Further simplification, however, is obtained when the

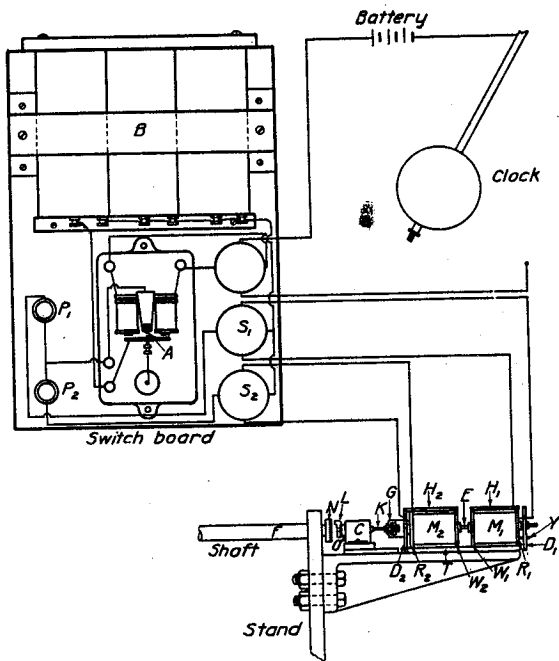

FIG. 8.—Time signal apparatus.

closures of the circuit, as by (P_1) and (P_2), are made automatically at intervals of one or more minutes by a clock-driven commutator. Also it is proposed to construct an apparatus with two counters arranged to operate alternately. The two-second pause may then be utilized without the necessity of waiting over every other minute.

The magnets (M_1) and (M_2) being practically alike, as stated above, the operations of connecting and disconnecting the counter are sensibly identical and the effect of inductive lag is eliminated. Also if (L) meshes to equal depth with the clutches (N) and (O), the errors due to the time required for (L) to free itself from the clutches at the beginning and end counter-balance each other. An error caused by the revolutions lost while (L) is traversing the clearance distance between it and the clutches is, however, present. This error is determined by the amount of clearance and the velocity of (L), the latter depending in turn on the pull of the magnets, the mass of the moving system, and the frictional resistance. Though as yet no separate study of this source of error has been made, the close agreement, within a few revolutions, of the results with those obtained by other methods and elsewhere indicate that the

apparatus is sufficiently accurate for the purpose for which it is intended. The separate readings themselves agree, under the best conditions, to within one-fourth to one-half a revolution.

A second, more complicated, and theoretically less accurate apparatus appears in figure 9. In this apparatus the counter is thrown in and held in by magnetic attraction, but is disengaged by a spring. The operations are timed automatically by electric signals from a clock, the observer having only to press a button twice and throw a switch once.

The counter is mounted on a sliding rod fixed to the armature of an electromagnet, seen at the right of the figure, and is fitted with a star wheel which engages a pin in the end of the shaft whose speed is to be determined. A helical compression spring encircling the sliding rod holds the counter normally out of connection with the shaft.

The arrangement is such that current begins to flow through the electromagnet at the instant of a given time signal, and continues to flow, thus putting the counter into and holding it in connection with the shaft. Another signal, exactly a minute later, breaks the circuit of



FIG. 9.—Time signal apparatus used in calibrating master tachometer.

the electromagnet and the counter is disconnected. The necessary electrical connections for these operations are made by means of the switchboard seen in the center of figure 9.

Ordinarily only the relay (A) is actuated by the time signal. If the push button (D) is pressed, however, the relay (B) is also operated by the signal. (B) is provided with an insulated stud on the inner side of its armature, connected as shown, and when actuated puts itself and the counter magnet in connection with the 110-volt mains through the lamps (L), (M), and (N) in parallel. At the instant of the first signal occurring after (D) is pressed, therefore, the counter magnet is excited and the counter begins to record revolutions. Moreover, since the exciting of (B) itself maintains the connections, the current continues through the counter magnet. The counter is thus held in connection with the shaft and continues to count revolutions.

The switch (C) is now moved to the left. The contact with the central studs, which is made before that with the right-hand studs is broken, disconnects (B) from the mains but maintains the connection with the counter magnet through the lamps (L) and (M), so that counting still proceeds. The contact with the left-hand buttons merely rearrange the connections so that actuation of (B) will now disconnect the counter magnet from the mains

instead of connecting it as before. Accordingly, (D) being pressed, at the time of the next following signal, the counter magnet is disconnected. The counter is thus disconnected and ceases to record revolutions. The time and the revolutions both being known, the speed is readily calculated.

This apparatus has the relative disadvantages of complexity, comparative uncertainty in action, and, theoretically, of error due to the fact that the counter is connected and disconnected by different means—by magnetic attraction and by spring force, respectively. It is, therefore, not considered, on the whole, as desirable as the first apparatus described.

RESULTS OF TESTS ON AMERICAN AIRPLANE TACHOMETERS.

Detailed results of various tests on several types of American airplane tachometers are given below. A brief summary of these results has already been given in an earlier section of this report.

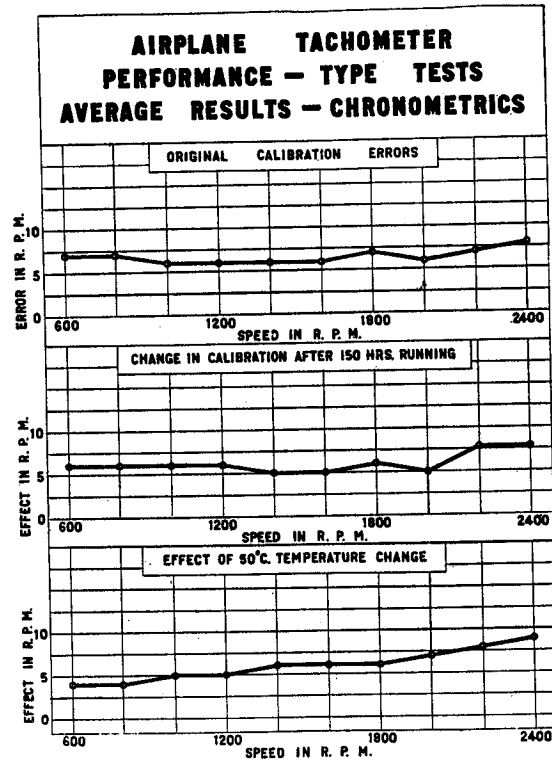

FIG. 10.

The following types were tested thoroughly: Chronometric, centrifugal, and magnetic. Other types, such as air viscosity and electric, were tested less completely but sufficiently to prove that they were not at present well adapted to airplane use. For this reason the second group of instruments were not given certain tests which they could probably pass successfully.

The performance of each of the chronometric, centrifugal, and magnetic types is first discussed separately and then compared with that of the other types.

CHRONOMETRIC TACHOMETERS.

Chronometric tachometers were studied for calibration errors, lag, effect of temperature change, tilting, and running on the calibration. Two makes, based upon the same principle but differing greatly in detail, were tested. In the following discussion these two makes are identified by the letters "A" and "B." A weighted mean of the results for the two makes is tabulated as the performance of the type, and is plotted in figure 10.

Calibration.—The calibration errors of a new instrument of this type are usually small. The average errors of 204 instruments, of which 79 were of make "A" and 125 of make "B," are tabulated below in Table I, together with the average errors of instruments of each make.

TABLE I

Speed in revolutions per minute.	Average errors in revolutions per minute.		
	Make "A."	Make "B."	Type.
600.....	9	5	7
800.....	9	5	7
1,000.....	8	4	6
1,200.....	7	5	6
1,400.....	6	5	6
1,600.....	6	5	6
1,800.....	6	7	7
2,000.....	6	6	6
2,200.....	7	7	7
2,400.....	9	7	8

The average error for all speeds was about 7 revolutions per minute for make "A" and 6 revolutions per minute for make "B."

The percentage of instruments having errors between the following limits—namely, greater than 20, 20 to 10, and 10 to 5, respectively—was 11, 69, and 20 for make "A" and 5, 46, and 49 for make "B."

Effect of running on calibration.—Table II shows the effect of 150 hours running and vibration on the calibration for 35 instruments of make "A" and for 51 of make "B" and also for the type.

TABLE II.

Speed in revolutions per minute.	Average effect in revolutions per minute.		
	Make "A."	Make "B."	Type.
600.....	7	5	6
800.....	6	6	6
1,000.....	6	6	6
1,200.....	7	5	6
1,400.....	5	5	5
1,600.....	6	5	5
1,800.....	6	6	6
2,000.....	5	5	5
2,200.....	8	5	7
2,400.....	8	6	7

It is seen that the average effect in each make is practically that of the type, or 6 revolutions per minute.

Of 35 instruments of make "A" 14 per cent showed maximum changes of 20 revolutions per minute or over, 57 per cent changes between 10 and 20 revolutions per minute, and 29 per cent showed changes less than 10 revolutions per minute.

Of 51 instruments of make "B," 8 per cent showed changes over 20 revolutions per minute, 45 per cent between 10 and 20 revolutions per minute, and 47 per cent less than 10 revolutions per minute.

Temperature.—The average effect of 50° C. change in temperature is tabulated below in Table III for 36 instruments of make "A" and 34 of make "B" and for the type.

TABLE III.

Speed in revolutions per minute.	Average effect in revolutions per minute.		
	Make "A."	Make "B."	Type.
600.....	7	0	4
800.....	8	0	4
1,000.....	9	1	5
1,200.....	9	1	5
1,400.....	10	2	6
1,600.....	11	1	6
1,800.....	11	1	6
2,000.....	13	2	7
2,200.....	13	2	8
2,400.....	15	3	9

It is seen that the effect is greater for instruments of make "A" than for those of make "B." The average effect for the type is small, the maximum being 9 revolutions per minute. It will be noticed that the temperature effect increases slightly with the speed.

Of a group of 36 instruments of make "A" tested for the effect of temperature change 14 per cent had effects equal to or greater than 25 revolutions per minute, 70 per cent between 15 and 25 revolutions per minute, and 16 per cent less than 15 revolutions per minute. Of 34 instruments of make "B" only one instrument showed an effect at any point of 25 revolutions per minute, the remaining 97 per cent having the maximum effect less than this amount.

Tilting.—Instruments of the chronometric type read the same for all positions of the axis with respect to the vertical.

Lag.—The chronometric tachometer has no lag due to friction and inertia such as is found in the centrifugal. A time lag is, however, characteristic, owing to the fact that the pointer is locked in position during each counting period. Consequently, any change in speed during this period, usually one second, will not be shown until its end, and may be considerable. But, if the speed is increased to a given value and held constant for a few seconds, the reading will be practically the same as if the speed had been decreased to the same value and held there.

A pointer-steadying device used in instruments of the type denoted make "A," causes a difference between up and down readings of 20 revolutions per minute or more, due to lost motion. This lost motion is purposely inserted, a steady pointer evidently being deemed by the manufacturers as more desirable than freedom from lag.

If chronometric tachometers do not have this special pointer-steadying device sudden slight jumps of the pointer are usually present. This is due to the fact that the teeth of the fine-toothed pinion do not always mesh correctly with those of the rack or counter gear, and slippage or sliding of one tooth upon its mate until proper mesh is made must occur before the mechanism functions properly. The maximum jump which could occur from this cause is in the neighborhood of 15 revolutions per minute. The jump observed in practice is usually less than 5 revolutions per minute.

Durability.—An idea of the durability of the chronometric tachometer is given by the following data: Of 50 instruments of make "A" tested for endurance, 14, or about 28 per cent, failed before the test was completed. Of 69 instruments of make "B," 14 or 20 per cent failed. The length of the test was 150 hours.

It is only fair to say, however, that of the failures of make "B" the larger number occurred in instruments of the earlier production. The later instruments were improved so that of the latter third of the instruments submitted to the tests the failures were few.

Conclusions.—It is seen that the performance of the chronometric type is very good as regards accuracy under different conditions of temperature, altitude, etc. Owing to the fact, however, that the readings are intermittent, it is not so satisfactory as an indicator for speeds which are changing. For instead of indicating the change in speed gradually as it occurs, it

shows all at once at the end of a given time interval the total change in speed which occurred during that interval. This lack of sensitivity is a serious defect for certain kinds of work and certainly is not a desirable feature for use in airplanes.

CENTRIFUGAL TACHOMETERS.

Centrifugal tachometers were studied for calibration errors, effect of running, tilting, lag, effect of temperature change and durability. Two makes, "C," and "D," both of the so-called governor type, were tested. The results of these tests are given below for instruments of each make, and a weighted mean of these results is tabulated as the average error for the type, and is plotted in figure 11.

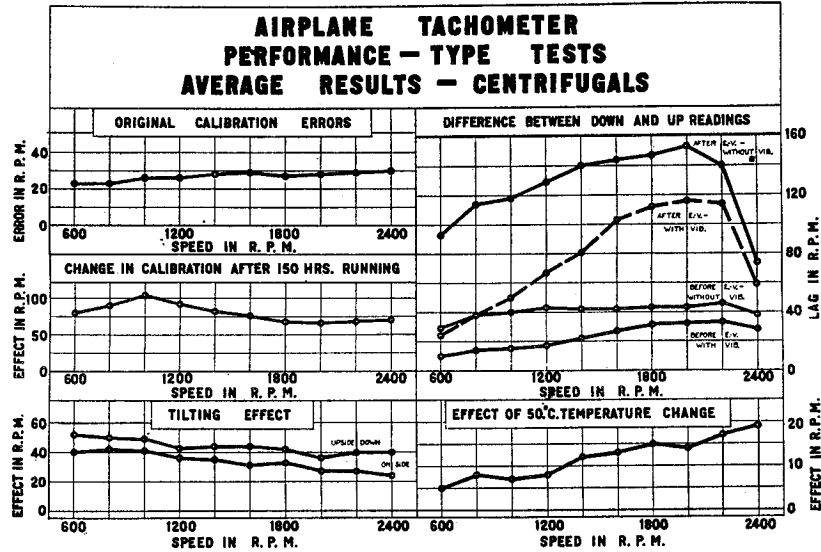

FIG. 11.

Calibration.—The average calibration errors of new instruments of the centrifugal type are somewhat higher than those of the chronometric type. The average errors of 73 instruments, of which 9 were of make "C" and 64 of make "D," are tabulated below, together with the average errors of each make.

TABLE IV.

Speed in revolutions per minute.	Average error in revolutions per minute.		
	Make "C."	Make "D."	Type.
600.....	24	23	23
800.....	20	25	23
1,000.....	20	31	26
1,200.....	23	31	26
1,400.....	25	30	28
1,600.....	28	29	29
1,800.....	27	28	28
2,000.....	27	28	29
2,200.....	30	28	29
2,400.....	31	29	30

The average error for all speeds was 26 revolutions per minute for make "C," 28 revolutions per minute for make "D," and 27 revolutions per minute for the type. Of make "C," 89 per cent had errors at some point of 20 revolutions per minute or more and of make "D," 71 per cent.

Effect of running on the calibration.—The average effect of 150 hours running and vibration on the calibration is shown below for 33 instruments of which 5 were of make "C" and 28 of make "D."

TABLE V.

Speed in revolutions per minute.	Average effect in revolutions per minute.		
	Make "C."	Make "D."	Type.
600.....	26	96	86
800.....	24	90	81
1,000.....	20	104	92
1,200.....	22	92	82
1,400.....	20	82	73
1,600.....	20	75	67
1,800.....	16	68	61
2,000.....	12	66	58
2,200.....	17	69	62
2,400.....	27	70	64

The average change in calibration caused by running is 20 revolutions per minute for make "C" and 81 revolutions per minute for make "D." The average effect for the type is 73 revolutions per minute.

Of make "C," the greatest effect observed at any point was 58 revolutions per minute; 80 per cent of the instruments tested showed an effect at one or more points of over 20 revolutions per minute.

Of make "D," 65 per cent had errors at some point of 50 revolutions per minute or more, 15 per cent between 50 and 20 revolutions per minute, and 20 per cent less than 20 revolutions per minute.

Tilting.—Table VI shows the effect of the position of the instrument with respect to the vertical. The error for each point was determined with the instrument (1) upside down and (2) on its side. In all cases the reading in these positions was higher than in the vertical position.

TABLE VI.

Speed in revolutions per minute.	Average change in reading due to tilting in revolutions per minute.					
	Upside down.			On side.		
	Make "C."	Make "D."	Type.	Make "C."	Make "D."	Type.
600.....	30	63	52	15	53	40
800.....	35	57	50	25	50	42
1,000.....	38	55	49	23	50	41
1,200.....	28	51	43	25	41	36
1,400.....	25	53	44	25	40	35
1,600.....	22	56	44	14	39	31
1,800.....	15	56	42	13	44	33
2,000.....	13	47	36	6	38	27
2,200.....	13	54	40	6	38	27
2,400.....	15	53	40	10	31	24

The average errors for make "C" are 23 and 16 revolutions per minute for the upside down and on side positions, respectively. For make "D" the corresponding average errors are 55 and 42 revolutions per minute.

Lag.—The differences between readings taken with decreasing speed and with increasing speed are tabulated below. Four tables are given showing the lag (1) before the endurance-vibration run without vibration, (2) the same with the instrument being vibrated while calibrated, (3) after the endurance-vibration run without vibration, and (4) after the endurance-vibration run with vibration. These values are shown graphically in the upper right-hand plot of figure 11. The effects of vibrating the instrument during the calibrations before and after the endurance run are evident from the data and plots; also the effect of the run itself.

TABLE VII.

Speed in revolutions per minute.	Average lag in revolutions per minute.											
	Before endurance-vibration run.						After endurance-vibration run.					
	(1) Without vibration.			(2) With vibration.			(3) Without vibration.			(4) With vibration.		
	Make "C."	Make "D."	Type.	Make "C."	Make "D."	Type.	Make "C."	Make "D."	Type.	Make "C."	Make "D."	Type.
600.....	2	36	29	4	13	10	27	129	93	10	29	24
800.....	9	46	38	6	20	14	35	158	114	18	44	38
1,000.....	11	48	40	7	20	15	40	162	118	16	61	50
1,200.....	15	50	43	8	23	17	41	178	129	25	81	67
1,400.....	14	49	42	10	29	22	42	195	140	22	100	81
1,600.....	19	48	42	12	36	27	41	201	144	27	128	103
1,800.....	20	49	43	14	42	31	45	204	147	31	139	112
2,000.....	22	49	43	16	43	32	50	211	153	27	146	116
2,200.....	25	52	46	13	46	33	54	187	140	30	142	114
2,400.....	23	42	38	15	36	28	39	93	74	29	69	59
Number of instruments tested....	9	34	43	9	13	22	5	8	13	2	6	8

For make "C" the average lag before the endurance-vibration run is 16 revolutions per minute without vibration, and 11 revolutions per minute when vibrated. The corresponding values after the endurance run are 41 revolutions per minute and 23 revolutions per minute respectively. The lag was increased by from 100 to 150 per cent as a result of the 150 hours run.

For make "D" the average lag before the endurance-vibration run is 47 revolutions per minute without vibration and 29 revolutions per minute when vibrated. The corresponding values after the endurance run are 172 revolutions per minute and 94 revolutions per minute. For this make the effect of running was to increase the lag by from 200 to 250 per cent.

The averages for the type are (1) 40 revolutions per minute before the run and without vibration, (2) 23 revolutions per minute with vibration, (3) 125 revolutions per minute after the run without vibration, and (4) 76 revolutions per minute with vibration. The average effect of vibration during the calibration is to reduce the lag by about 40 per cent; the average effect of the endurance run is to increase the lag by over 200 per cent.

Temperature.—The average effect of 50° C. change in temperature is tabulated below for 3 instruments of make "C" and 11 of make "D" and for the type.

TABLE VIII.

Speed in revolutions per minute.	Average effect in revolutions per minute.		
	Make "C."	Make "D."	Type.
600.....	1	9	5
800.....	5	10	8
1,000.....	6	8	7
1,200.....	5	10	8
1,400.....	8	16	12
1,600.....	7	19	13
1,800.....	11	18	15
2,000.....	9	19	14
2,200.....	10	24	17
2,400.....	11	25	19

The average effect for make "C" is 7 revolutions per minute, for make "D" 16 revolutions per minute, and for the type 12 revolutions per minute.

Durability.—The centrifugal tachometer is not likely to break down until badly worn. A few instances of the pointer being loosened on its staff were, however, noticed and in one or two instruments defective steel balls in the end bearings caused an unsteady pointer. In all other cases the instruments continued to indicate, although in many cases the reading was in error by several hundred revolutions.

Conclusions.—It is seen that the average performance of instruments of make "C," although poor, is much better in most respects than that of instruments of make "D." This is explained

in part by details of design, make "C" having a light, high speed governor while make "D" has a heavy and comparatively slow speed governor. Most of the difference, however, is due to superior quality of workmanship and finish of critical parts found in make "C."

The average performance of the centrifugal type tachometer is far from satisfactory especially in regard to lag and change of calibration with use. The average errors or effects for all speeds are as follows: Calibration error, 2 per cent; effect of 150 hours running on calibration, 5 per cent; original lag, 3 per cent without vibration and 2 per cent with, and after 150 hours' running 9 per cent without vibration and 5 per cent with; effect of 50° C. temperature change, 1 per cent; effect of tilting, 4 per cent for the "inverted" position and 3 per cent for the "on side" position.

MAGNETIC TACHOMETERS.

Magnetic tachometers were studied for calibration errors, effect of running and vibration, tilting, lag, effect of temperature change, and durability. All instruments tested were of the same make and design. The results are shown graphically in figure 12.

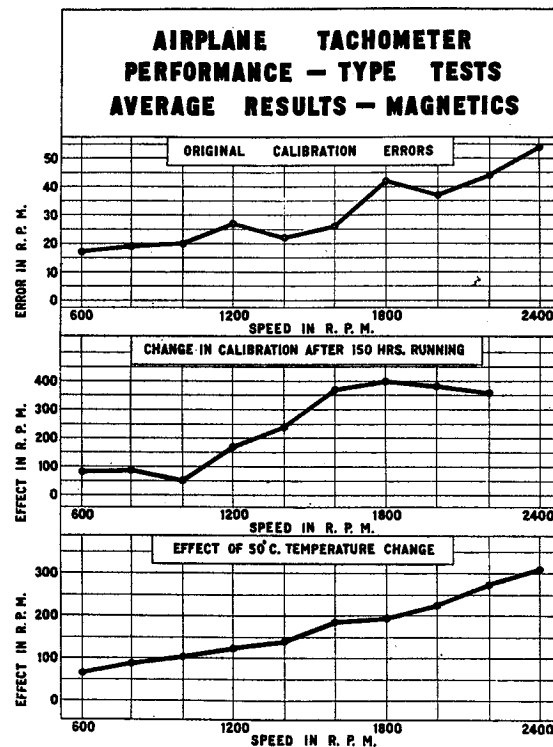

FIG. 12.

Calibration.—The average calibration errors of six magnetic tachometers are tabulated below.

TABLE IX.

Speed in revolutions per minute.	Average error in revolutions per minute.
600.....	17
800.....	19
1,000.....	20
1,200.....	27
1,400.....	22
1,600.....	26
1,800.....	42
2,000.....	37
2,200.....	44
2,400.....	54

The average error for all speeds is 31 revolutions per minute.

No instrument had all errors less than 20 revolutions per minute; 60 per cent had some error over 50 revolutions per minute, one instrument having errors as high as 375 revolutions per minute. The errors of this instrument are not included in the data tabulated above, as they were considered anomalous.

Effect of running on calibration.—The effect of running and vibrating for 150 hours on the calibration of one airplane model magnetic tachometer is shown in the table below.

TABLE X.

Speed in revolutions per minute.	Average effect in revolutions per minute.
600.....	81
800.....	88
1,000.....	50
1,200.....	170
1,400.....	239
1,600.....	367
1,800.....	400
2,000.....	384
2,200.....	360

The average effect is 237 revolutions per minute; the maximum effect is 400 revolutions per minute at a speed of 1,800, or an error of about 22 per cent.

This is considered very poor performance.

Tilting.—The magnetic tachometer reads practically the same for all positions of its axis.

Lag.—The lag in the magnetic tachometer rarely exceeded 20 revolutions per minute. If the speed were held constant after being either decreased or increased the reading would be the same after a second or two, the lag being caused wholly by sluggishness of action.

Temperature.—The average effect of about 50° C. change in temperature is tabulated below for five instruments.

TABLE XI.

Speed in revolutions per minute.	Average effect in revolutions per minute.
600.....	64
800.....	86
1,000.....	103
1,200.....	122
1,400.....	139
1,600.....	184
1,800.....	194
2,000.....	223
2,200.....	273
2,400.....	308

In general the effect of lowering the temperature is to increase the reading for a given speed, that of raising the temperature to decrease it.

The average effect is 170 revolutions per minute. The maximum effect is 308 revolutions per minute at a speed of 2,400, or about 13 per cent.

Durability.—The magnetic tachometers tested for endurance all showed some serious defect as a result of the run. The usual and most serious was a pitting of the lower jewelled bearing in which the electrically conducting drum or disc was mounted. This allowed it to move into a stronger magnetic field and hence give a greater deflection for a given speed.

Conclusions.—It is seen that the performance of the magnetic airplane tachometers was not very satisfactory. The average calibration error was about 2½ per cent for full scale reading; the effect of running was 16 per cent and the effect of temperature was 11 per cent. Also the instruments seemed to be of too delicate construction.

COMPARISON OF THE TYPES.

Data showing the performance of the different types of airplane tachometers under various conditions are given in Table XII. The tests are far from being complete; nevertheless a discussion of such results as are given may be of interest.

TABLE XII.—Airplane tachometer performance—type tests.

Speed in revolutions per minute.	Error or effect in revolutions per minute.																		
	Calibration error.			Effect of 50° C. temperature change.			Effect of 150 hours running.		Lag error.		Tilting error.		Change at 16,000 feet altitude.						
	Chromometric.	Centrifugal.	Magnetic.	Air viscosity.	Electric.	Chromometric.	Centrifugal.	Magnetic.	Width vibration.	With-out.	In-verted.	On side.							
600.....	7	23	17	29	22	4	5	64	50	24	6	86	81	10	58	29	52	40	16,000
800.....	7	23	19	31	29	4	8	86	60	12	6	81	30	14	30	38	50	42	10
1,000.....	6	26	20	50	37	5	7	103	83	9	6	92	50	15	26	40	49	41	
1,200.....	6	26	27	48	41	6	8	122	94	24	6	82	170	17	13	43	46	36	
1,400.....	6	28	22	49	44	6	6	139	111	29	6	73	239	23	11	42	44	35	8
1,600.....	6	29	26	50	43	6	13	184	126	5	67	367	27	13	42	44	31	
1,800.....	6	27	42	45	40	6	15	194	135	5	61	400	31	19	43	42	33	
2,000.....	6	28	37	54	7	14	223	155	5	58	384	32	18	43	36	36	
2,200.....	7	29	8	17	273	5	62	360	33	25	46	27	20	
2,400.....	8	30	54	9	19	308	7	64	28	33	46	27	24	

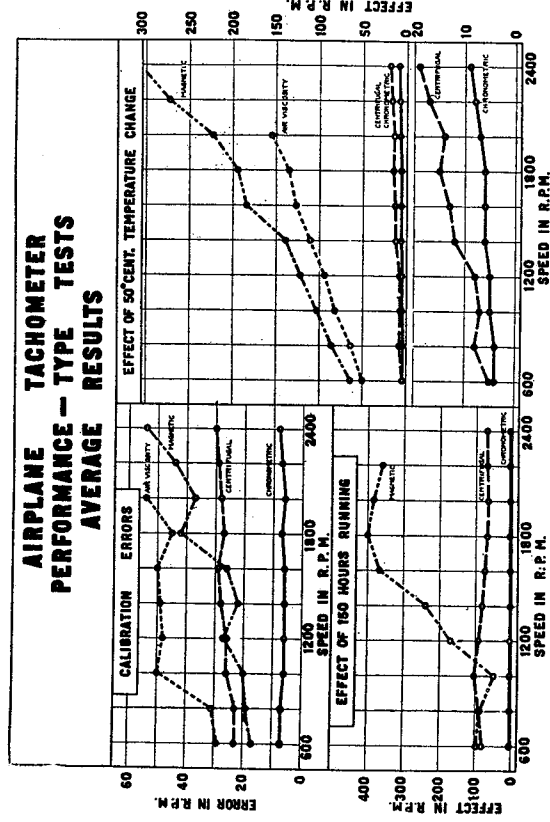

FIG. 13.

The plot, figure 13, shows graphically for comparison (1) the average calibration errors of the chronometric, centrifugal, magnetic, and air viscosity types, (2) the average effect of 150 hours running on the calibration of the chronometric, centrifugal, and magnetic types, and (3) the average effect on the calibration of 50° C. temperature change for the chronometric, centrifugal, magnetic, and air viscosity types. The numerical data for these plots is tabulated in Table XII, mentioned above. The results of the different tests are discussed below.

Calibration.—The type of instrument, number of instruments tested, average calibration error for all speeds in revolutions per minute, average percentage error at speeds of 600 and 2,400, and the percentage of instruments having their average errors in excess of the specification limit of 20 revolutions per minute, are shown below. The percentage error of most instru-

ments is usually less at full scale deflection than at lower speeds, as is evident from the fact that the error in revolutions per minute is more or less constant throughout the scale.

TABLE XIII.

Type.	Number of instruments tested.	Average error.		Percentage instruments having average error over 20 revolutions per minute.	
		Revolutions per minute.	Per cent.		
			600		2,400
Chronometric.....	204	7	1.2	0.4	7
Centrifugal.....	73	27	3.8	1.3	63
Magnetic.....	6	31	2.8	2.3	100
Electric.....	1	37	3.7	2.2	100
Air viscosity.....	2	45	4.8	2.7	100

The instruments are arranged in the order of their apparent reliability for calibration. Allowance must be made, however, for the fact that relatively few instruments of the magnetic and air viscosity type and only one of the electric type were tested.

Temperature.—Table XIV is a summary of data showing the average effect in revolutions per minute for all speeds of 50° C. temperature change and in per cent at speeds of 600 and 2,400 revolutions per minute for five types of airplane tachometers. The last column shows the percentage of the instruments tested which had average effects exceeding 20 revolutions per minute.¹

TABLE XIV.

Type.	Number of instruments tested.	Average effect of 50° C change.		Percentage instruments having average effect over 20 revolutions per minute.	
		Revolutions per minute.	Per cent.		
			600		2,400
Chronometric.....	70	6	0.7	0.4	9
Centrifugal.....	14	12	.8	1.3	15
Electric.....	1	20	4.0	2.1	0
Air viscosity.....	2	101	8.3	7.8	100
Magnetic.....	5	170	11.0	12.8	100

The instruments are arranged in the order of their apparent reliability for temperature effect.

The performance of the air viscosity and magnetic types for different conditions of temperature is very poor, so poor, in fact, as to eliminate the types as they exist from further consideration with those suitable for use in airplanes.

Effect of running on calibration.—Table XV is a summary of data showing the average effect at all speeds, of 150 hours running and vibration in revolutions per minute, and in per cent for three types of airplane tachometers. The last column shows the percentage of instruments tested which had average effects exceeding 20 revolutions per minute.² The averages for the different speeds are given in Table XII.

¹ Error allowed by Air Service specifications.

² Error allowed by Air Service specifications.

TABLE XV.

Type.	Number instruments tested.	Average effect of 150 hours' running.			Percentage instruments having average effect over 20 revolutions per minute.
		Revolutions per minute.	Per cent.		
			600	2,400	
Chronometric.....	86	6	1.0	0.3	10
Centrifugal.....	33	73	14.3	2.7	80
Magnetic.....	1	237	13.5	15.0	100

It is seen that the performance of the centrifugal and magnetic types is very poor as regards consistency of calibration with use.

Lag.—Table XVI shows the average difference in readings for all speeds taken at the same speed with decreasing and increasing speeds. The instruments were vibrated while being tested and had not previously been run. Table XII gives the complete data and also data showing the average lag in the centrifugal type without the vibration.

TABLE XVI.

Type.	Number of instruments tested.	Average lag with vibration.		
		Revolutions per minute.	Per cent.	
			600	2,400
Centrifugal.....	22	23	1.7	1.2
Air viscosity.....	2	24	9.7	1.1
Magnetic ¹				
Electric ¹				
Chronometric ²				

¹ Small; not observed quantitatively.

² See discussion.

At slow speeds the lag in the air viscosity type is much greater than in the centrifugal. However, if the speed be held constant after being raised or lowered the lag will practically disappear in the air viscosity type while in the centrifugal type it will not. Hence actually, the lag effect in the air viscosity type is less serious than in the centrifugal.

Tilting.—The centrifugal type is the only one tested which read differently for different positions of its axis. Data showing the average change at all speeds in the reading at normal or vertical position for two other positions are given in Table XVII and complete data for the different speeds in Table XII.

TABLE XVII.

Type.	Average effect of tilting.					
	In revolutions per minute.		In per cent.			
	Upside down.	On side.	Upside down.		On side.	
			600	2,400	600	2,400
Centrifugal.....	44	34	8.7	1.7	6.7	1.0
Chronometric ¹						
Magnetic ¹						
Air viscosity ¹						
Electric ²						

¹ No effect observed.

² Not tested; believed small.

It is seen that in the centrifugal type the effect of position of the axis of the instrument with respect to the vertical is by no means negligible.

Effect of air-pressure change.—The air viscosity type is the only one of those tested affected by altitude change. Data taken at a barometric pressure corresponding to that at 16,000 feet altitude is given in Table XII.

It is seen that the average effect observed at any speed did not exceed 20 revolution per minute, the maximum average percentage error being 1.0 per cent.

Durability.—Of the four types, chronometric, centrifugal, magnetic, and air viscosity, the centrifugal type gives the best performance as regards durability. The percentage of breakdowns, complete or partial, so that readings can not easily be taken is small. However, the reading may be considerably different from the true speed as is seen from the foregoing discussion of the characteristics of the type.

About 20 per cent of the instruments of the chronometric type broke down so as to necessitate repairs and replacement of parts. Also, in several cases, the escapement failed to start unless the instrument was shaken. In use on a plane this would necessitate dismantling.

Instruments of the magnetic type did not break down completely, but the pointer gradually became more and more unsteady until finally readings could not be taken.

The air viscosity type was not tested for endurance, but it is believed that its behavior under airplane conditions would be similar to that of the magnetic type.

Weights.—The average weights for the different types are given in Table XVIII.

TABLE XVIII.

Type.	Weight in pounds.
Chronometric.....	1.3
Centrifugal.....	1.0
Magnetic.....	2.0
Air viscosity.....	1.4
Electric.....	4.8

Attention is called to the relatively large weight of the electric type.

REPORT No. 129.

POWER-PLANT INSTRUMENTS.

PART III.

THERMOMETERS FOR AIRCRAFT ENGINES.

By E. F. MUELLER and R. M. WILHELM.

SUMMARY.

This part describes the principal types of distance-reading thermometers for aircraft engines, including an explanation of the physical principles involved in the functioning of the instruments and the proper filling of the bulbs. Performance requirements and testing methods are then given, concluding with a discussion of the sources of error and results of tests.

INTRODUCTION.

The term "airplane thermometer" is usually used to designate an instrument, which indicates the temperature of the water or oil at some point in the respective circulating systems of these liquids in an aircraft engine. Thermometers may be used for experimental purposes, to measure temperatures existing in various other regions about the engine or aircraft, but such thermometers will not be discussed in this article.

Thermometers designed for use in the water-cooling system have been used to measure the temperature of the lubricating oil. The use of thermometers for this purpose is not general, although oil thermometers were specified as part of the standard equipment of several types of American airplanes. The discussion which follows will apply more especially to instruments used to measure the temperature of the circulating water.

The bulb of the thermometer is usually placed in the top of the radiator and for this reason these instruments have sometimes been called "radiator" thermometers.

FUNCTIONS.

A temperature indicator for aeronautic engines may serve one or more of the following purposes: To indicate engine trouble, possibly before any of the other instruments would show this; to assist in operating the engine at maximum efficiency; to indicate whether the water is at or near its boiling point, or the oil is at such a temperature that its lubricating properties are impaired; to warn that the engine is becoming too cold to start up again after having been cut off in gliding; to warn that the water is in danger of freezing or that the oil is too thick to flow. The last condition may be encountered in cold climates when the engine is allowed to stand idle for a sufficient period, or on long glides from high altitudes.

REQUIREMENTS.

The requirements for an airplane engine thermometer may be summarized as follows:

1. The indicator must be at a distance from the bulb. This precludes the use of the liquid in glass or other nondistance-reading type of thermometer.
2. The thermometer must indicate temperatures in the range 0° to 100° C. but since the operating temperature of the water in an airplane engine is in the neighborhood of 80° under normal conditions, it is obvious that the instrument should be most reliable over this part of

the scale. Readings in the neighborhood of 0° C. may also be of importance since in long glides or occasionally under other conditions the temperature of the water may be reduced to such an extent that the danger of freezing becomes serious.

3. At high altitude the instrument will be subjected to external pressures much lower than normal atmospheric, and the indications should not be significantly affected by such changes.

4. The gage and connecting tubing may be at various temperatures, since that part of the tubing passing close to the engine may be heated considerably above the other parts of the tubing and gage, while at high altitudes and in winter some parts may be cooled much below the temperature met with at lower altitudes or in summer. The error from this source should be reduced to negligible proportions.

5. The instrument should be light in construction and as small in size as is compatible with strength and visibility. Furthermore, nonferrous materials have been preferred.

POSSIBLE TYPES OF THERMOMETERS.

The types and forms of distance reading thermometers available for practical use may be classified under two general heads; namely, electrical and pressure. A consideration of the relative advantages of these two general types led to the adoption in this country of the pressure instrument for airplanes, on account of smallness in size and weight, ruggedness of construction and immediate availability. This last factor was important since the pressure thermometers on the market could be easily adapted for airplane work, while it would have been necessary to evolve practically a new type of electrical indicator to fulfill the conditions imposed.

A type of electrical thermometer taken from captured German planes consists essentially of a resistance thermometer connected to a small ohmmeter and a battery. It indicates the temperature only at the time when a push button switch is operated.

The advantage of this type of instrument over the pressure thermometers are sensitivity to rapid changes in temperature, absence of errors due to change in atmospheric pressure, or change in temperature of connections. However, its greater complexity, costliness, weight, and inconvenience in that the pilot must operate the push button to observe the reading, offset the advantages above enumerated.

PRESSURE THERMOMETERS.

Pressure thermometers comprise a bulb containing a liquid or gas or both, and connected by means of capillary tubing, to some form of pressure gage.

The pressure thermometers which have been used up to the present time in this country on airplanes are either of the vapor pressure type, with a free surface of the liquid in the bulb, or the liquid filled type, with the liquid completely filling the thermometer.

Two distinct types of gages have also been used, one employing an ordinary Bourdon tube with sector and pinion multiplying mechanism, the other, a long Bourdon tube of many turns which is connected through a bimetallic temperature compensator to the pointer.

Either type of gage could be used for either of these two types of pressure thermometers. The ordinary Bourdon gage, however, has been used up to the present time only for vapor pressure instruments, while the multiple turn Bourdon tube has been used for the liquid filled instruments.

The photograph, figure 1, shows a liquid filled thermometer (A), and two types of vapor pressure thermometers (B and C) used on American airplanes. Interior views of the bulbs and gages of these instruments are also shown.

PRINCIPLES UNDERLYING ACTION OF VAPOR PRESSURE THERMOMETERS.

The action of the vapor pressure thermometer depends upon the fact that the pressure inside the thermometer is determined solely by the temperature of the free surface of the liquid. It follows that the thermometer must be so constructed that one free surface is always in the bulb. If this condition is fulfilled the readings of the instrument will not be sensibly affected by changes in the temperature of the gage and capillary. It must be remembered, however, that the liquid will always accumulate in the cooler parts if possible, i. e., if these parts are not

already filled with liquid (or with noncondensable gas). The two extreme cases to be considered, therefore, are: (1) The bulb is the hottest part of the system. (2) The bulb is the coldest part of the system. The former is the more important and more usual condition. Assuming that the thermometer contains no noncondensable gas, the gage and capillary will fill with liquid and there must still be liquid in the bulb if the thermometer is to indicate properly. It follows that *the volume of liquid must be greater than that of the gage and capillary combined*. An inter-

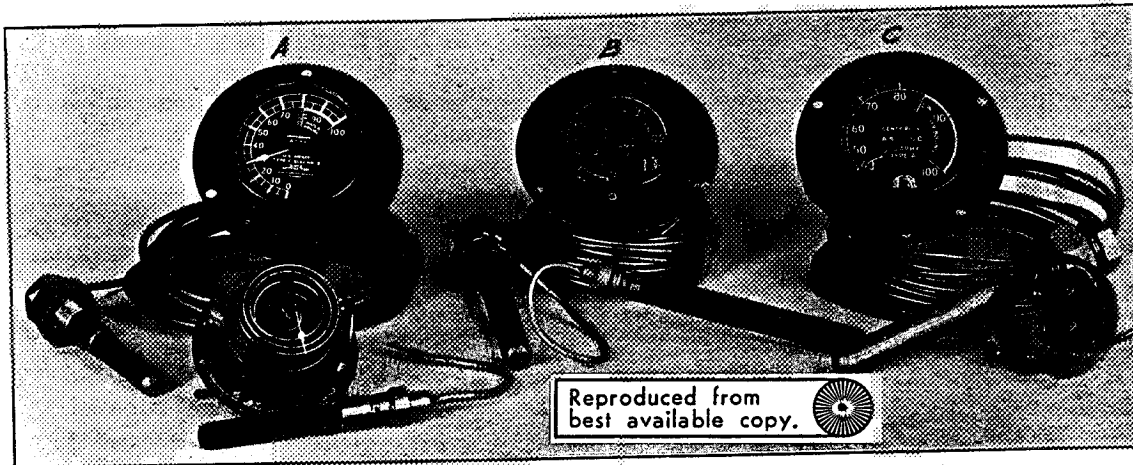

FIG. 1.—Types of thermometers.
A. Liquid filled thermometer with long Bourdon tube.

B. Methyl-chloride vapor-pressure thermometer.
C. Ether vapor-pressure thermometer with ordinary Bourdon gage.

esting variation of this case is that in which the volume of liquid is barely sufficient when gage and capillary are at room temperature, but when these are cooled, the liquid in them contracts, so that all the liquid in the system is insufficient to fill the gage and capillary as shown in figure 2 (a). The thermometer under such conditions indicates properly when the parts other than the bulb are at room temperature but fails when these are cooled. The second condition, in which the bulb is coldest, may occur occasionally. In this case, the liquid goes to the bulb, but if the volume of liquid is more than sufficient to fill the bulb, the free surface will be in the capillary and the thermometer will fail to indicate properly as shown in figure 2 (b). A less extreme case is that in which the capillary or a part of the capillary alone is heated to a higher temperature than either bulb or gage. In this case the liquid will be driven out of the heated parts of the capillary. A thermometer containing more than enough liquid to fill the bulb will fail on the simplest test, namely, it will indicate the temperature of either the capillary or the gage when the bulb is put in ice. It is evident, from the above, that *the volume of the liquid should be insufficient to fill the bulb at any temperature*. From the above two conditions in regard to amount of liquid required it can be seen that *the combined volumes of the capillary and gage must be less than that of the bulb*. It is evident that if a relatively small bulb is required the capillary must be very fine in order that the last-named condition may be fulfilled.

The problem of obtaining proper volume relations may be simplified by the use of a transmitting liquid in the tubing and gage. Such a liquid must have a high boiling point, low freezing point, be noncorrosive, and must neither react with nor mix with the volatile liquid. If such a liquid is used to fill the gage and capillary, the effective volume of these is reduced to practically zero, and the necessary volume of the bulb and of the volatile liquid are greatly reduced.

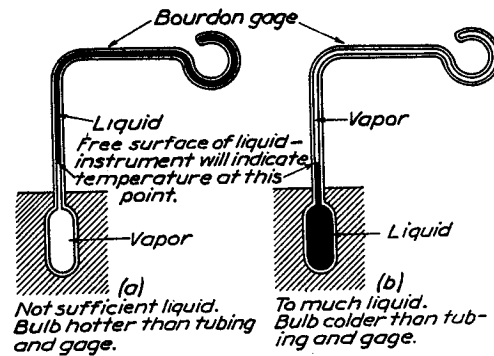

FIG. 2.—Defective vapor pressure thermometers.

The transmitting liquid type of thermometer has not come into use in this country, although some experimental instruments have been made and submitted for test. The transmitting liquid was a mixture of glycerin and water, the volatile liquid being methyl chloride.

Either ethyl ether or methyl chloride is used as the volatile liquid in the majority of the vapor pressure thermometers in use at the present time on American airplanes. A brief consideration of some of the liquids that could be used may be of interest.

The following table gives the properties of some of the liquids which could be considered for use in a vapor pressure thermometer for an airplane engine, and also the number of degrees centigrade that a thermometer using such a liquid would read high at an altitude of approximately 19,000 feet (one-half atmospheric pressure):

Liquid.	Boiling point.	Vapor pressure at 100° C.	Error at 19,000 feet altitude.	
			Bulb temperature 0° C.	Bulb temperature 80° C.
	° C.	Atmospheres.	° C.	° C.
Alcohol (ethyl).....	78.3	2.2	62	10
Ether (ethyl).....	34.6	8.4	27	5
Sulphur dioxide.....	-10	27.8	7	1.3
Methyl ether.....	-24	30 ?	6	1
Methyl chloride.....	-24	30 ?	5	(1)
Ammonia.....	-33.4	61	2.5	.5

¹ Less than 1° C.

The volatile liquid used must be stable, readily obtained and purified, must not act on the metals with which it will be in contact, must have a sufficiently low freezing point, and its critical temperature must be above 100° C. The table shows that the effects of variations in external atmospheric pressure occurring at different altitudes cause smaller variations in the indications of thermometers filled with liquids having lower boiling points, and consequently higher vapor pressures in the working temperature range. The high-pressure gages used with these liquids are also more robust than the low-pressure gages would be. Methyl chloride, methyl ether, and sulphur dioxide fulfill the requirements as regards physical properties. However, on account of availability and ease in handling the liquid, ethyl ether filled thermometers were the only thermometers of the vapor pressure type produced in quantity up to near the termination of the recent war.

PRINCIPLES UNDERLYING ACTION OF LIQUID-FILLED THERMOMETERS.

The liquid-filled thermometers utilize the thermal expansion of a liquid. The increase of pressure with temperature is nearly linear in the range 0° to 100° C. for the liquids used. Alcohol has been used in these instruments, which are made to have an internal pressure at 0° of about 100 pounds per square inch, the pressure increasing to 700 or 800 pounds at 100° C. This large pressure range requires the use of a rugged gage mechanism and makes the indications of the instrument practically independent of the variations of atmospheric pressure with altitude. Since changes in the temperature of the gage and capillary tubing affect the internal pressure, some form of compensator must be used if these parts contain sufficient volume to make the error from this source appreciable, since they are subjected to considerable changes of temperature in use.

A bimetallic compensating helical coil has been employed. This coil is connected at one end to the pointer spindle and at the other end to the Bourdon tube. It may be designed to compensate for changes in the temperature of the gage alone or of the gage and capillary together. This compensator can not eliminate errors due to changes in the temperature of the capillary alone. It is therefore necessary that the volume of the bulb be large relative to the volume of the capillary.

CHOICE OF TYPE.

Since the vapor pressure of a liquid does not change linearly with changes in temperature but increases much more rapidly at higher temperatures, vapor-pressure thermometers have a very open scale in the upper part of the temperature range and a relatively contracted scale in the lower part of the range. If the upper part of the range is the most important this is an advantage, but there is a corresponding disadvantage if readings in the lower part of the scale are of importance. The liquid-filled type has an equally divided scale.

It has been previously pointed out that vapor-pressure thermometers are subject to error if used at high altitudes and that this error is greater the lower the vapor pressure of the liquid used and the lower on the scale the readings are taken. This error for liquid-filled thermometers may be reduced to almost negligible proportions, and is the same regardless of the part of the scale on which the reading is taken.

It may therefore be said that if it is important that the thermometer shall give accurate indications at lower temperatures, the liquid-filled type is to be preferred.

When correctly filled the readings of the vapor-pressure thermometers are sensibly independent of the temperature of the gage and capillary. The liquid-filled thermometer is subject to error if the temperature of the gage and capillary differs from that at which it was calibrated. This error may in some cases be eliminated by employing a compensator as previously mentioned, but in general it may be said that if the most important consideration were that the indications of the thermometer should be independent of the temperature of the capillary, then the vapor-pressure type should be chosen.

SPECIFICATIONS FOR AND TESTING OF AIRPLANE THERMOMETERS.

The discussion of airplane thermometers which has been given is based on data obtained as the result of a considerable amount of investigation extending over about a year and a half, during which time many tests were made for the military branches of the Government and specifications written in cooperation with the War Department.

These specifications, which were revised from time to time, include, apart from the actual details of construction, a series of tests which were devised for the purpose of inspection.

These tests included primarily determinations of (a) the scale errors at various temperatures under ordinary laboratory conditions, (b) the error that would be introduced if the tubing or gage either together or separately were heated or cooled to temperatures corresponding to those that might be encountered under actual conditions of use, and (c) the error caused by the reduction of the external pressure on the gage, the condition met with at high altitudes.

Other special tests were made from time to time including vibration tests to ascertain the comparative effect of vibration on different instruments, tests to determine the mechanical hysteresis due to poor gage mechanism, the lag in the reading when the temperature was changed quickly, tests to determine whether the indications changed with time or in shipment, and chemical analyses of the liquids taken from the instruments.

APPARATUS USED IN TESTS.

Very little special apparatus was required for these tests, since the thermometry laboratory was already equipped for similar work.

A well-stirred water bath, heated by a bunsen burner, served, with the aid of a standard thermometer, for the determination of the scale errors, the mechanical hysteresis in readings due to faulty gage mechanism, and the lag of the readings.

For cooling the tubing and gage, use was made of a low temperature bath cooled by the expansion of carbon dioxide.

For determining the error caused by the reduction of the external pressure on the gage an ordinary vacuum desiccator evacuated to the required extent was used. The pressures were read on a mercury manometer.

RESULTS OF TESTS

As a result of the testing, the following conclusions have been reached in regard to the accuracy of the instruments examined and the magnitude of the errors that may be expected under various conditions:

In general it was found that well-made instruments of either the ether vapor-pressure or the liquid-filled types would indicate the temperature of the bulb to within an accuracy of from 1° to 3° C. under ordinary laboratory conditions.

Although methyl chloride and methyl ether vapor-pressure thermometers were produced in quantity toward the end of the war, only a small number were received at the Bureau of Standards for test and some of these were experimental instruments. The results of tests showed that it was possible to construct methyl chloride or methyl ether thermometers possessing an accuracy comparable with that of the liquid-filled types, but in general the readings, especially in the neighborhood of 0° C., were less reliable in the vapor-pressure thermometers.

Mechanical hysteresis errors can be attributed to backlash and friction in the moving parts of the gage mechanism. The advantages of the directly connected gage as used on the liquid-filled thermometer over that of the sector and pinion type, especially if the latter is poorly constructed, was very clearly demonstrated.

The readings of the vapor-pressure type of instrument are theoretically independent of the temperature of the gage and capillary tubing. The heating and cooling tests previously

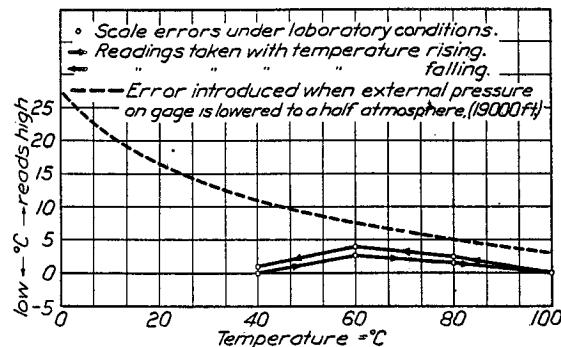

FIG. 3.—Results of tests of ether vapor-pressure thermometers.

mentioned were therefore intended as checks on the filling of the instruments, i. e., to determine whether the proper amount of liquid was contained with reference to the volume of the various parts. Although some of the first thermometers submitted as samples were found not to be properly filled, this defect did not appear in the thermometers furnished under the specifications.

The liquid-filled thermometer is subject to error when the capillary is heated separately from the gage. For lengths up to 12 feet it was found that the capillaries could be made small enough in diameter to permit moderate heating or cooling without introducing excessive error. For longer capillaries the error due to this cause was appreciable, as, for example, a 23-foot tube cooled to -9° C., introduced an error of about 9° C. in the reading. It has been previously stated that a compensator is employed on the liquid-filled thermometers to allow for the expansion or contraction of the liquid in the gage. This compensator may also be so designed as to allow for the expansion and contraction of the liquid in the tubing provided both gage and tubing are heated and cooled at the same time and the same amount. Tests of instruments so designed indicated that it was possible to compensate very accurately for these temperature changes.

The errors caused by decreasing the external pressure on the gage of airplane thermometers depend on the pressure range of the instruments.

The liquid-filled instruments if properly designed will be practically free from error from this source, since the pressure range can be varied at will. Tests of the instruments of the type submitted showed that the error had been reduced to within 1° C. by the use of a suitable gage and sufficient pressure range.

The theoretical errors due to change in external pressure on the gage of vapor pressure instruments have been previously indicated. The errors actually found agreed very closely with those predicted.

Impurities in the liquids used in vapor pressure thermometers may clog up the capillary tubing and render the instruments inoperative. A number of methyl chloride and methyl ether thermometers were found defective from this source. Difficulty in securing pure methyl chloride or methyl ether in sufficient quantities interfered with the manufacture of satisfactory instruments of this type.

Figures 3, 4, and 5 show characteristic calibration curves obtained from observations taken for ether vapor pressure, methyl chloride vapor pressure, and liquid-filled thermometers.

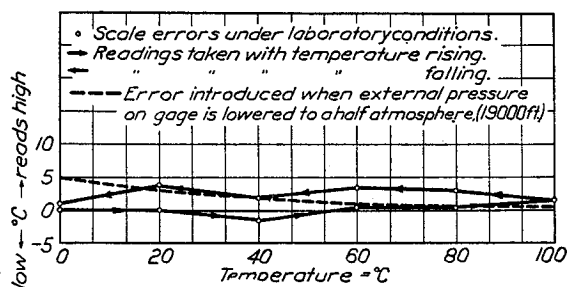

FIG. 4.—Results of tests of methyl chloride vapor-pressure thermometer.

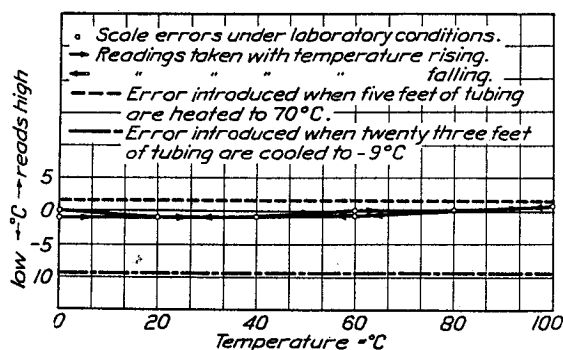

FIG. 5.—Results of tests of liquid filled thermometers.

The charts also indicate the magnitude of the error due to reducing the external pressure on the vapor pressure thermometers and to either heating or cooling the capillary of a liquid-filled instrument.

Vibration tests made in the laboratory failed to indicate the superiority of one instrument over the other from the standpoint of ability to withstand hard usage.

Other reasons for failure of the instruments submitted were loose pointers and the breaking of the capillaries. These are frequent causes of failure of the instruments in the field.

It is unfortunate that very little data could be obtained in regard to the behavior of the instruments under actual conditions of use, although it is understood that those passing the tests proved satisfactory.

REPORT No. 129.

POWER-PLANT INSTRUMENTS.

PART IV.

AIR PRESSURE AND OIL PRESSURE GAGES.

By H. N. EATON.

SUMMARY.

This part discusses briefly the use of air and oil pressure gages on aircraft, and describes the construction of various American, British, and German gages. Methods of testing these instruments at the United States Bureau of Standards are described and sample reports are given.

DESCRIPTION OF AIRCRAFT PRESSURE GAGES.

Air and oil pressure gages are used on aircraft to measure the pressure of the air in the gasoline tank and the pressure in the oil system of the engine. The importance of keeping the air pressure in the gasoline tank at the proper value is obvious when it is remembered that it is this pressure which forces the gasoline to the carbureter. The usual pressure is about 3 pounds per square inch, although a value as great as 5 pounds per square inch may sometimes be reached. A safety valve is used to prevent the pressure from increasing beyond this limit. Since the life of the engine depends upon its receiving a sufficient supply of oil, the gage which indicates the oil pressure is also of very great importance. It shows not only whether the pressure is maintained within the proper range but also any stoppage which may prevent the flow of oil.

The pressure gages just mentioned are of the Bourdon tube type in the great majority of cases. A Bourdon tube is constructed by flattening a circular tube, bending the flattened tube longitudinally to the arc of a circle, and sealing the ends. (See fig. 1.) Now if the pressure is introduced into

the tube, the cross section tends to increase in area and this change in cross section tends to straighten the tube longitudinally. When a Bourdon tube is used in an instrument, one end is mounted rigidly to the case while the other end is left free to deflect and operate the mechanism. Bourdon tubes possess the advantage that the deflection produced is closely proportional to the pressure applied, but they have very little power when utilized as pressure indicators and so are not adapted to use in instruments where the pressure element is called upon to exert an appreciable force. To change the range of pressure for which the gage is adapted, it is simply necessary to use a Bourdon tube of different stiffness.

Figure 2 shows a group of American, British, and German pressure gages. All of these gages are of the Bourdon tube type except the Prerauer and Scholz gage, figure 2(F), which has a corrugated diaphragm element.

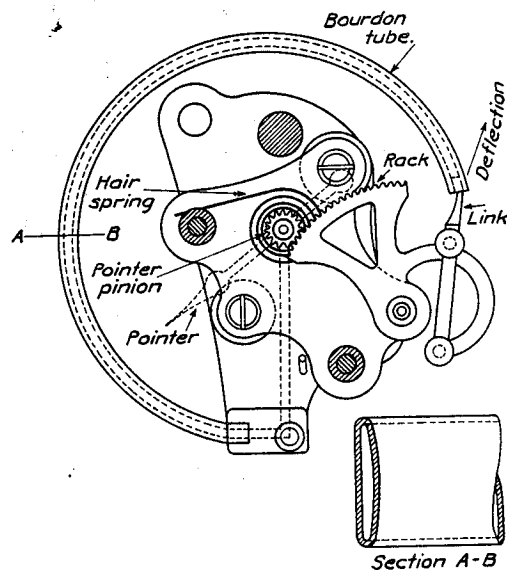

FIG. 1.—Pressure gage.

Figure 2(A) shows an American oil-pressure gage whose construction is typical of that used in American aircraft oil and air pressure gages. This gage is of the concentric type; that is, the axis of rotation of the hand is at the center of the dial. A number of American airplane pressure gages have been built with the hand eccentric with respect to the dial, but the mechanism is not materially different from that shown in figure 2(A).

The pressure is applied to the inside of the Bourdon tube through a screw connection under the main casting. The free end of the tube deflects as indicated in figure 1, thus operating the rack through a connecting link. The rack in turn operates the pointer pinion on which the pointer is mounted. A hairspring is attached to the shaft carrying the pointer pinion so as to eliminate the effect of backlash. The Bourdon tube is usually made of seamless drawn bronze.

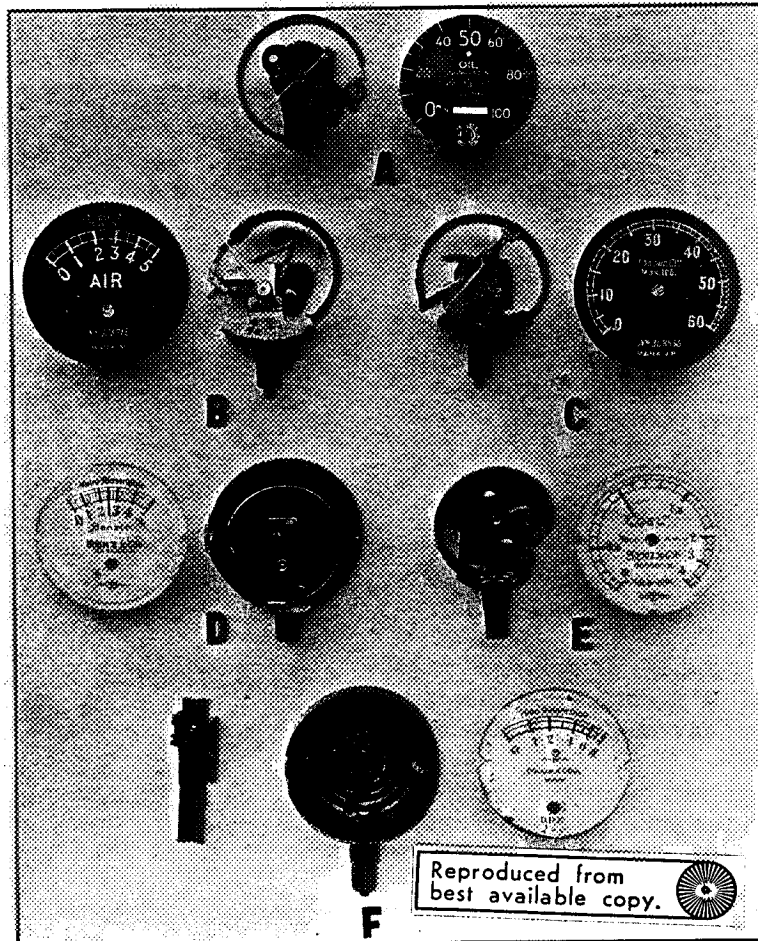

FIG. 2

The graduations on the dial of this particular instrument are not luminous, but it is customary to have the pointer and the principal graduations and figures finished with luminous paint.

A British air-pressure gage is shown in figure 2(B). In this instrument the hand is mounted eccentrically with respect to the dial. Owing to the small angular motion required of the pointer, the rack and pinion are replaced by a linkage which is simpler to construct and will give practically a uniform scale. Stops are arranged for the zero position and for preventing the Bourdon tube from deflecting so far as to overstrain the metal in case of an accidental application of overpressure. The tube is made of seamless phosphor bronze tubing. Neither the pointer nor the graduations on the dial are luminous. A conspicuous red line is printed at the point of the scale corresponding to 2.5 pounds per square inch indicating the proper pressure to be maintained.

Figure 2(C) shows a British oil-pressure gage with a range of 0 to 60 pounds per square inch. A rack and pinion are used to transmit the motion of the free end of the Bourdon tube to the pointer. No hairspring is used to eliminate backlash, but instead the teeth are made V shaped, so that there is practically no lost motion between the rack and the pinion. No stop is provided to prevent the Bourdon tube from being deflected too far. The specifications, however, require this gage to sustain a total pressure of 180 pounds per square inch without damage; consequently the stop is hardly needed.

Figure 2(D) shows a Benz air-pressure gage of German manufacture having a range of from 0 to 5 pounds per square inch. Here, as in the British air-pressure gage, only a small angular motion of the pointer is utilized, and a linkage is used to transmit the motion of the free end of the Bourdon to the pointer.

A German oil-pressure gage is shown in figure 2(E). The instrument has a range of from 0 to 4 kilograms per square centimeter (approximately 0 to 57 pounds per square inch). A rack and pinion are used and a hairspring eliminates backlash in the mechanism. A stop curved to fit the outer surface of the Bourdon tube is mounted on the case. If the Bourdon tube is subjected to overpressure, it comes in contact with this stop for a considerable portion of its length and so overstrain of the metal comprising the thin walls of the tube is prevented.

Figure 2(F) shows a German air-pressure gage of the diaphragm type. As the diaphragm deflects it raises with it a helical surface shown above the diaphragm in the figure. The pointer is mounted on a shaft which carries an arm with a small wheel to provide rolling contact with the helical surface. Consequently, as the surface rises it rotates the arm and the pointer shaft. A hairspring takes up backlash. Owing to the fact that the relation between the applied pressure and the deflection of the diaphragm is not linear, this instrument has a scale whose graduations are far from uniform.

TESTS OF AIRCRAFT PRESSURE GAGES.

The tests to which airplane pressure gages are subjected are designed to bring out clearly any characteristics of an instrument which would make it unsuitable for use under the conditions peculiar to aeronautics. In particular, the gages must work satisfactorily under severe vibration and at low temperatures. The tests specified are as follows:

1. Calibration.
2. Vibration.
3. Temperature.
4. Friction.
5. Endurance.
6. Interchangeability.

CALIBRATION TEST.

When the gages are received they are calibrated at room temperature in order that their scale errors under normal laboratory conditions may be ascertained. The air-pressure gages are calibrated directly against a mercury column, since the range of the instruments (usually 0 to 10 pounds per square inch) is sufficiently small to permit the use of this method. Air pressure is applied sufficient to deflect the pointer to the 2-pound division while the instrument is tapped, and the true pressure is read on the manometer which is graduated in pounds per square inch. This process is repeated for successive 2-pound intervals over the scale, first with increasing pressure, then immediately afterwards with decreasing pressure. The difference in the manometer readings with increasing and with decreasing pressure is a measure of the elastic hysteresis of the instrument (if backlash and friction are eliminated).

Since oil-pressure gages have a much greater range than the air gages, usually from 0 to 120 pounds per square inch, it is not convenient to use a mercury column as the standard for measuring the pressures. Instead a dead weight oil gage tester is used. This tester consists of a vertical cylinder in which a piston of known cross-sectional area floats on oil. An oil-filled tube connects this cylinder with the gage under test. Weights can be placed upon the piston, and since the cross-sectional area of the latter is known, the pressure thus set up in the oil system is

also known for any given weight. For purposes of testing, the weights are designed to alter the oil pressure as they are applied by successive increments of 5, 10, or 20 pounds per square inch.

The calibration of the oil gages is carried out just as described for the air gages. Readings are taken for pressure changes of 20 pounds per square inch over the range of the instrument with both increasing and decreasing pressure.

VIBRATION TEST.

This test is made to determine the effect of prolonged vibration upon the instrument, such as may occur under flight conditions. The result may be simply to change the calibration of the instrument slightly or to loosen parts of the mechanism.

After the calibration test just described has been completed, the gages are fastened rigidly to a vibrating stand and for five hours are subjected to vibration similar to that experienced in actual service. At the end of this time they are recalibrated. A comparison of the two calibrations, one before, the other after, vibration, serves to determine any change produced by this treatment, and a brief examination of the instrument suffices to detect any looseness which may have been produced in the mechanism.

TEMPERATURE TEST.

The effect of temperature changes upon the calibration of each type of gage is determined by tests at approximately -10° C and $+40^{\circ}$ C. For this purpose the gages are mounted in a chamber in which the temperature can be varied over the necessary range. The air in the chamber is brought to the desired temperature and maintained at that point until the gages have acquired the temperature of the air. The calibration is then made in a manner similar to that already described.

FRICTION TEST.

Pressure is applied sufficient to deflect the pointer over a small portion of its range and a reading is taken without tapping the instrument. The instrument is then tapped and a second reading is taken while the pressure is held constant. The difference in the two readings is a measure of the friction at this point of the scale. The process is repeated at several other points of the scale. The average change in reading due to tapping the instrument is taken as the friction error. Friction is rarely serious in pressure gages, as the vibration of the airplane tends to eliminate its effect. Instruments are rarely rejected because of friction unless there is some defect of the mechanism which causes the pointer to stick and move in a jerky manner when the pressure is varied uniformly.

ENDURANCE TEST.

Three distinct endurance tests are given airplane pressure gages at the Bureau of Standards:

- (a) A *drift* test to determine the effect of prolonged application of pressure.
- (b) A *seasoning* test to determine the effect of repeated applications of pressure.
- (c) An *overpressure* test.

(a) *Drift*.—The increase in reading of an instrument when subjected to a given pressure for a prolonged period is called its "drift" or "creep." This effect is due to the yielding under stress of the metal which makes up the pressure element. The gage is subjected for five hours to sufficient pressure to produce approximately one-half of full scale deflection. A reading is taken when the pressure is first applied and another at the end of the five-hour interval. The difference in the two readings is taken as the drift.

(b) *Seasoning*.—A calibration is given immediately after 200 applications of pressure sufficient to produce full-scale deflection have been given the gage. A comparison of this calibration with the room temperature calibration following the five-hour vibration of the instrument shows the effect of repetition of pressure.

(c) *Overpressure*.—In order to test the ability of the gages to withstand the occasional accidental excess pressures which may be given them, both types of gage are subjected to a momentary overpressure. After the application of this overpressure, the gages are rested for

a few minutes so that the worst of the temporary elastic effect caused by the overpressure may disappear; then a final calibration is given. Since the overpressure often causes a permanent change in the calibration of the gage, this final calibration should be taken as characteristic of the instrument at the conclusion of the tests. In the overpressure test a pressure of 25 pounds per square inch is applied to air gages of 10-pound range, while a pressure of 180 pounds per square inch is applied to oil gages of 120-pound range.

It is desirable to rest the instruments for several hours between each two consecutive tests in order to afford time for the disappearance of the temporary elastic effects produced by the last test.

INTERCHANGEABILITY TEST.

Since both the air and oil pressure gages used by the Air Service are of the same size and general construction, certain parts can be made standard for all. Consequently it is required that cases, connections, bezels, and cover glasses shall be interchangeable. On this account the dimensions of such parts are checked at the conclusion of the performance tests of the instruments.

TOLERANCES FOR AIRCRAFT PRESSURE GAGES.

The following table summarizes the tolerances specified for aircraft oil and air pressure gages used by the United States Air Service. The values are in pounds per square inch.

Table of tolerances for aircraft pressure gages.

Gage.	Range.	Vibration.	Scale error -10° C to +40° C.	Friction.	Drift.	Over- pressure (amount).
	<i>Pounds per square inch.</i>					
Air.....	0-6	0.3	0.3	0.3	0.3	15
Do.....	0-10	0.3	0.3	0.3	0.3	25
Oil.....	0-120	3.0	3.0	3.0	3.0	180

The following are typical reports for two American pressure gages, one air and one oil.

REPORT ON AIR PRESSURE GAGE, SERIAL NO. 156.

Range of instrument, 0 to 10 pounds per square inch.

The results of the tests applied to this instrument follow. Corrections are in pounds per square inch and are to be added algebraically to the instrument reading.

Instru- ment reading.	Corrections at +25° C.		Corrections at +25° C.		Corrections at -8.5° C.		Corrections at +46° C.		
	Before vibration.		After vibration.		Cold run.		Hot run.		
	Up.	Down.	Up.	Down.	Up.	Down.	Up.	Down.	
<i>Pounds per square inch.</i>									
2.....	+0.1	0.0	+0.1	0.0	+0.1	+0.1	0.0	0.0	
4.....	+0.1	+0.1	+0.1	+0.1	+0.1	+0.2	+0.1	0.0	
6.....	0.0	-0.1	0.0	0.0	+0.1	+0.1	0.0	-0.1	
8.....	0.0	0.0	0.0	-0.1	+0.2	0.0	-0.1	-0.2	
10.....	0.0		+0.1		+0.1		-0.1		
Change in reading due to—								Average.	
Vibration.....								<i>Pounds per square inch.</i>	
High temperature.....								0.0	
Low temperature.....								+0.05	
Repetition.....								-0.10	
Drift (at 5 pounds per square inch).....								0.0	
Overpressure.....								0.1	

REPORT NATIONAL ADVISORY COMMITTEE FOR AERONAUTICS

REPORT ON OIL PRESSURE GAGE, SERIAL NO. 157.

Range of instrument, 0 to 120 pounds per square inch.

The results of tests applied to this instrument are as follows:

Instru- ment reading.	Corrections at +25° C.		Corrections at +25° C.		Corrections at -6° C.		Corrections at +42° C.		
	Before vibration.		After vibration.		Cold run.		Hot run.		
	Up.	Down.	Up.	Down.	Up.	Down.	Up.	Down.	
<i>Pounds per square inch.</i>									
20.....	+2.0	0.0	+1.5	0.0	+3.0	0.0	+1.5	0.0	
40.....	-1.0	-2.0	0.0	-1.5	0.0	-1.0	-0.5	-2.5	
60.....	0.0	-3.0	-1.0	-2.5	0.0	-1.5	-1.5	-2.5	
80.....	0.0	-2.0	-0.5	-1.5	0.0	0.0	-1.5	-2.5	
100.....	+1.0	0.0	+0.5	0.0	+2.0	+1.5	-0.5	-1.5	
120.....	+3.0	-----	+2.5	-----	+4.0	-----	+0.5	-----	
Change in reading due to--								Average.	
								<i>Pounds per square inch.</i>	
Vibration.....								+0.05	
High temperature.....								+0.75	
Low temperature.....								-0.95	
Repetition.....								+0.05	
Drift (at 60 pounds per square inch).....								0.5	
Overpressure.....								+0.2	

REPORT No. 129.

POWER PLANT INSTRUMENTS.

PART V.

GASOLINE DEPTH GAGES AND FLOWMETERS FOR AIRCRAFT.

BY JOHN A. C. WARNER.

GASOLINE DEPTH GAGES.

The development of a satisfactory gage for indicating the depth of fuel in the reservoirs of aircraft has received much attention from instrument designers both in America and in foreign countries. As yet, however, their efforts have not met with unqualified success owing to the unfavorable conditions under which these instruments function.

Such an instrument must be so designed as to be compact in form, light in weight, easily attached to the tank and removed therefrom, and so mounted as to be accessible to the pilot. Furthermore, it is desirable that the instrument be easily adaptable to tanks of different depths, and that the system allow for mounting the indicating gage at a distance from the tank; this latter feature is necessary in cases where the reservoir is at some distance from the pilot. The ideal instrument should be as simple as is consistent with good operation characteristics; it should have as few working parts as possible, and should function properly under the varying conditions of vibration, temperature, pressure, etc., which are encountered in service.

It is the object of this paper to consider the principal types now in use, to make a general summary of the advantages and disadvantages of each type, and to outline the methods employed in their testing and calibration.

FLOAT TYPE.

Several of the most common and most satisfactory gages incorporate the float principle in their construction (see figs. 1 and 2). In general, this type has the advantage of simplicity of construction and operation, while its greatest disadvantages are found in the tendency of moving parts to stick, and in the structural difficulties which ordinarily result in a more or less cumbersome arrangement not easily adapted to satisfactory installation on aircraft. In spite of the disadvantages, however, the instruments of the float type present a promising basis for the future development of depth gages.

Float-and-swinging-rod gage.—Figures 1 (A) and 2 (A) show assembled and disassembled a gage which combines the float with a swinging rod and suitable indicating head to show the fuel depth. Three vertical stationary rods extend from the base of the indicating head to a stay-plate to which they are rigidly attached at their lower extremities near the bottom of the tank. A fourth rod with a rigid angle-arm at either end is free to swing about a center pin mounted on the stay-plate and fitting loosely through a hole in the extremity of the lower angle-arm. The upper angle-arm is attached at the lower extremity of a vertical indicator spindle extending upward through a protective housing to the indicating head.

The two halves of the split cylindrical shellacked cork float, seen in its lowest position in figure 1 (A), are held apart by an aluminum spacer so as to admit one of the stationary vertical rods at one side of the slotted opening, and the swinging rod at the other. These rods are held in a definite position relative to the float by small guide rollers which also provide a bearing with little friction as the float rises and falls with changes in gasoline level. The float and rods

are so designed and mounted that the free rod is caused to swing in a definite path as the float changes its position. This motion is transmitted through the upper angle-arm to the indicator spindle above mentioned.

At the upper end of this spindle is a toothed sector, figure 2 (A), which engages a pinion mounted upon the vertical center axle of a cylindrical rotating scale, the divisions of which are marked upon the curved surface of the cylinder. A cylindrical glass ring with a diameter slightly larger than that of the rotating scale surrounds the latter and provides an observation window at one side where a section of the indicator housing is cut away.

Inasmuch as this instrument is adapted to use on tanks under pressure it is necessary that the glass ring be mounted upon a gasket which rests upon the inner base surface of the indicator housing. A screw top, also provided with a cork gasket resting upon the upper surface of the glass, covers the indicator and makes it air-tight. An air-tight connection is likewise made

at the joint between tank and gage by means of a fitting mounted on the tank and threaded to accommodate a ring-clamp, shown in the illustration. A cork gasket serves to make the joint free from leaks.

This type of gage generally operates in a reasonably satisfactory manner when properly mounted and handled, and is widely used. However, inasmuch as a very small component of the buoyant force of the float is effectively used in causing the rod to swing, there is great possibility of sticking, with resulting incorrect indications. This type also has the disadvantage of being more or less cumbersome and not well adapted to distant indication.

Float twisted-strip gage.—An older type of gage than the one described above is shown assembled and disassembled by figures 1 (B) and 2 (B). The hollow metal float is seen at its extreme lower position. Two vertical guide rods extending from indicator base to stay-plate at the bottom of the tank restrict the float motion to a vertical path as the float-guide pulleys rest upon the rods. A spiral twisted metal strip passes through a slotted opening through the center of the float so that as the latter moves along its vertical path, the twisted strip is

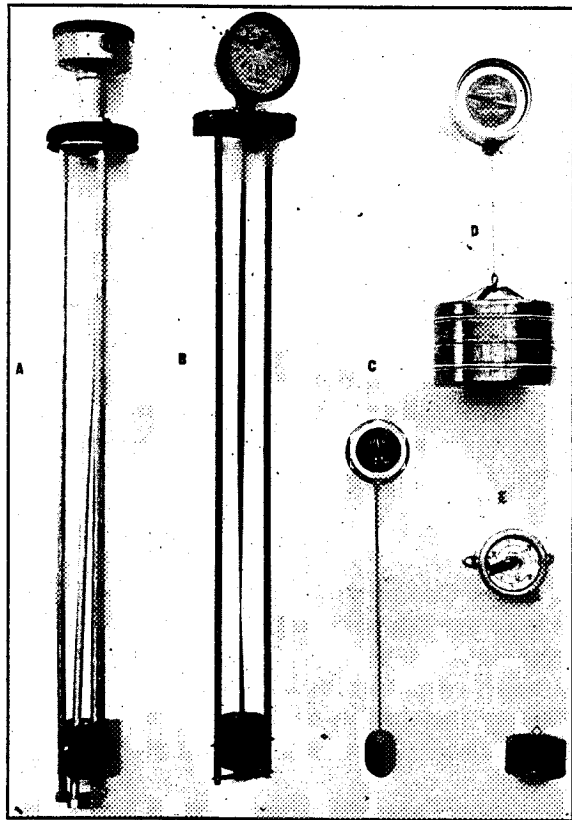

FIG. 1.—Float Type Gasoline Depth Gages—Assembled.

caused to turn like a loose fitting screw of very long pitch in the corresponding nut.

The rotation of the strip which extends upward into the indicator housing is there transmitted through a pair of bevel gears to the indicating pointer. The cover-glass is held in place by a bezel ring. This joint is made air-tight by means of a cork gasket.

The advantages and disadvantages of this gage are practically the same as those of the swinging-rod instrument. The frictional difficulties are usually greater in this type.

Float-and-lever gage.—The float-and-lever type of gage as illustrated assembled and disassembled by figures 1 (C) and 2 (C) is little used on American airplanes. However, it deserves a brief description.

The float composed of balsa wood is attached at the end of a wire lever which extends directly to the gage head, where it is bent at right angle to pass through a brass sleeve which screws into the back of the case. The indicating device with which this instrument is equipped

is one of the simplest. As is clearly shown in figure 2 (C) the float lever carries a magnetized steel bar at the indicator end. This bar rotates with changes of float position and acts magnetically upon the steel pointer through a thin air-tight separating wall case integral with the case. The scale of the instrument shown is graduated to give indications of the last 20 gallons in the tank only. The pointer is centered on the dial by means of a pivot point centrally mounted thereon. A cover-glass held by a bezel ring covers the gage.

It is seen that this type of indicator has the advantage of simplicity, and because of the absence of the necessarily air-tight joint usually found between glass and case is freer from the possibility of leakage. The case is threaded so as to be easily mounted upon a brass tank-fitting shown in the illustration. This gage has the disadvantage of being adapted to comparatively few installations and does not lend itself well to the requirements of distant indication.

Float-and-cord gage.—One of the simplest float gages is that which consists of a cork or sheet metal float, usually in the form of an air-and-water-tight cylindrical or spherical chamber, connected to an indicator by means of a light braided silk cord in such a manner as to give indications

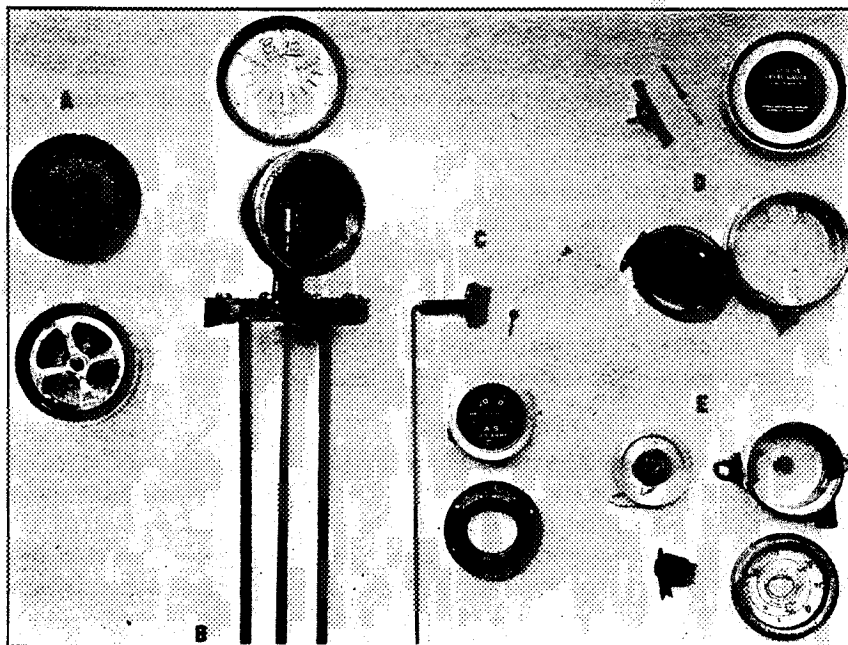

FIG. 2.—Float Type Gasoline Depth Gages—Disassembled.

of the depth of fuel in the tank. Figures 1 (D) and 2 (D) illustrate an instrument of this type recently designed by the Engineering Division, United States Air Service.

The cylindrical brass float has a diameter of 134 millimeters, a depth of 93 millimeters, and weighs approximately 600 grams. When installed on the tank this float is restricted in its motion to a vertical path by means of a fixed sheet metal tube, of diameter slightly greater than that of the float, and reaching from the top of the tank to a point near the bottom. A braided silk cord connects the float with the indicator gage, and the design is such that the gage may be mounted at a distance from the tank. In this case the cord passes through a tube of small diameter with suitable roller fittings at the bends.

At the point of entrance into the case of the gage the cord passes over a roller and thence to the main pulley member, upon which it is wound by the action of a coiled flat metal spring. The motion of this pulley is transmitted to the magnetized pointer bar (see illustration) through a train of gears which are interchangeable so as to make the gage readily adaptable to tanks of different depths. The first set of gears provides a pointer movement of 330° for a 50-inch change in float level, while the second combination gives a pointer movement

of 120° for a 10-inch change of level. The pointer is acted upon magnetically through the dial plate by the magnetized pointer bar mentioned above and moves over the scale marked upon the dial plate as the pointer bar changes its angular position. The case is covered by a glass held in place by a suitable bezel ring, making a tight joint with the case.

A float-and-cord gage of German manufacture is pictured in figures 1 (E) and 2 (E). The cylindrical metal float member has a diameter of 67 millimeters, a depth of 44 millimeters, and weighs approximately 92 grams. As in the design above described this float moves in a vertical path within a guide tube whose diameter is slightly greater than that of the float, and in a similar way connects by means of a cord with the main pulley member of the indicator.

The pointer is attached to a bronze rack (see fig. 2 (E)), which is mounted on the face of the rotating pulley, so as to engage a pinion fixed to the end of the pulley bearing. The rack is free to move radially. When the pulley is rotated by the cord attached to the float, the rack is rotated with it and forced outward radially by the fixed pinion, thereby causing the end of the pointer, which is attached to the rack, to describe a spiral path on the dial. In this way the pointer may make several revolutions without confusing the readings.

Float-resistance gage.—Several of the foreign gages, such as the French Electro-Jauge, depend upon electrical means to show the position of the float in the tank. The float is held in the usual manner by guide rods. An additional vertical column parallel to the guide rods and passing through the cork float has a bare wire resistance winding along its entire length; contact with this resistance element is made by a brush mounted on the float.

As the float changes its position with changes in gasoline level, the amount of resistance cut into the circuit by the float contact varies. A galvanometer, properly graduated and mounted upon the instrument board, shows the pilot the amount of fuel in the reservoir by giving an indication of the current flow through the resistance in the circuit of which the galvanometer forms a part.

This type of gage is well adapted to remote indication. It is too complicated in construction, however, does not hold its adjustment well, and is likely to get out of order.

PRESSURE TYPE.

Gasoline depth gages of the pressure type involve the use of a totally different principle from that of the float type described above. (See figs. 3 and 4.) The principle upon which this design is based is that of the pressure difference between the top and bottom of the gasoline reservoir caused by the head of gasoline. In general, this type is well adapted to distant reading, and the indicator is usually mounted on the instrument board at some distance from the reservoir to which it is connected by means of metal tubing of small bore.

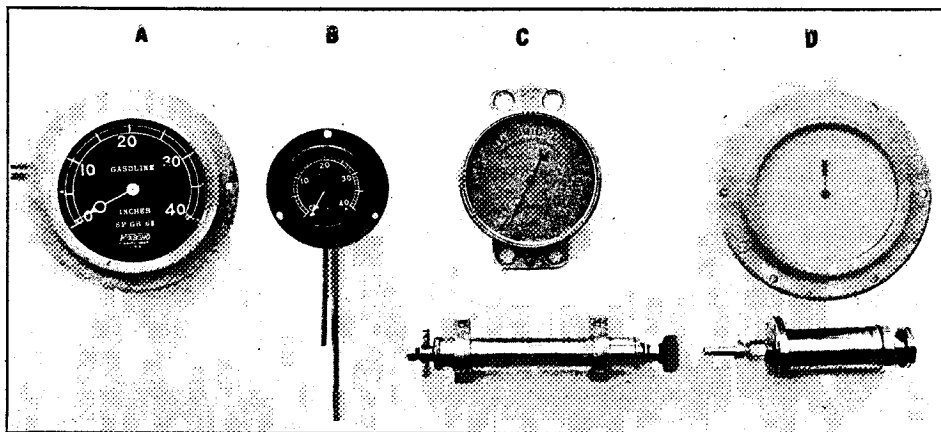

FIG. 3.—Pressure Type Gasoline Depth Gages—Assembled.

This arrangement possesses the disadvantage of being more liable to leakage, and consequent hazard to the aircraft and passengers, a particularly important point with fighting machines, when the tubes are in constant danger of breakage from gunfire.

Aneroid gage.—Figures 3 (A) and (B), 4 (A) and (B) show views of assembled and disassembled American gasoline depth gages of the pressure type which depend on a stack of nine aneroid chambers for pressure indications. Two metal tubes of small diameter lead from the gasoline reservoir to the indicator. One of these tubes extends into the tank to within about one-quarter of an inch of the bottom, while the second tube simply connects to the top of the reservoir above the surface of the liquid. The former then transmits a pressure, equivalent to the air pressure above the gasoline plus that due to the head of gasoline, to the space surrounding the aneroid chambers in the air-tight indicator case to which it is connected. The latter tube transmits the air pressure only to the space inside the aneroid boxes with which it communicates. Thus it will be seen that the elastic aneroid system will assume its position corresponding to the differential pressure existing between the top and bottom of the reservoir—i. e., a pressure equal to that of the hydrostatic head of gasoline.

Two wire coils soldered to the edges of the aneroid chambers at one side prevent that side from moving when pressure is applied, so that the expansion is taken up by a tilting action of

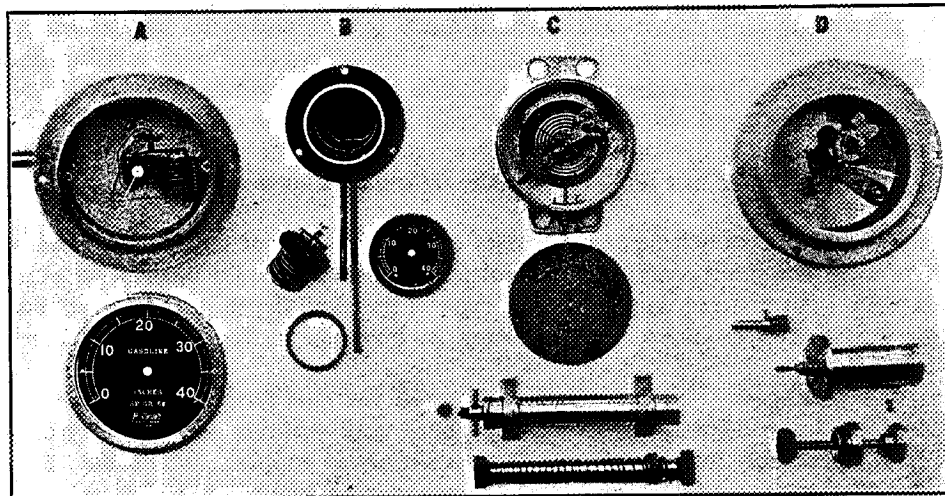

FIG. 4.—Pressure Type Gasoline Depth Gages—Disassembled.

the stack. This motion of the aneroids is preferable to the straight expansion, such as would take place without the restraining wires; for by the tilting action the connecting lever is given a proper motion which it transmits, through a link, to a toothed sector. The sector in turn transmits the motion to the pinion mounted on the pointer arbor. A flat spiral spring holds the pointer in equilibrium and takes up the backlash.

Figures 3 (C) and 4 (C), 3 (D) and 4 (D) show two foreign types of gasoline depth gage for use on reservoirs which are not under pressure. A small hand pump connected to a tube extending from the indicator to the bottom of the fuel reservoir serves to supply enough air to equalize the pressure due to the head of gasoline in the tank. When the pump is operated so as to supply a pressure equal to that of the head of gasoline, bubbles of air are formed at the lower end of the tube and rise to the surface of the liquid. This equalizing pressure is transmitted through a tube to the indicator which is properly graduated to show the depth of fuel in the tank.

The French instrument shown with its pump assembled and disassembled in figures 3 (C) and 4 (C) uses a single aneroid chamber for the pressure element. The action of this type is similar to that described above and will be readily understood after examination of the illustration.

The British type of indicator shown assembled and disassembled in figures 3 (D) and 4 (D) uses, as its pressure element, a specially treated fabric diaphragm approximately 90 mm. in diameter. The air pressure from the hand pump exerts a force upon one side of this diaphragm, which then becomes distended. The resulting motion of the diaphragm is greater or smaller according as the necessary equalizing pressure for the head of gasoline is large or small. A rod supported at the center of the diaphragm transmits its motion to the indicating mechanism which needs no detailed explanation.

As mentioned above, instruments of the pressure type lend themselves readily to remote indication. They are, however, subject to various errors due to several causes, chief among them being leakage, friction, temperature changes, vibration, imperfect elastic properties of pressure element.

TESTING OF GASOLINE DEPTH GAGES.

Tests of float type gages.—Gages of the float type are tested in the laboratory to determine their calibration and operation characteristics, by properly mounting them on a gasoline tank equipped with a water-glass type of gage and provided with means for rapidly filling and emptying.

A careful preliminary inspection of the gage will usually disclose any important causes for poor operation, such as bent parts, etc. The gage which appears to be in good working condition, is first mounted on the tank and a calibration is made by comparing its indications with those of the tank gage as the gasoline level is changed. This is first done with a rising liquid surface and then with a descending surface. Differences in the two readings are usually due to lost motion in the mechanism and should not be excessive. Readings should be taken both with and without tapping so as to determine the frictional error. In case the float or other part sticks so badly that slight jarring will not move it, the instrument should be readjusted before final calibration.

It is sometimes advisable to conduct rough tests of the tightness of metal floats and also of the buoyancy of cork floats, although any difficulties of the kind would usually be noticed in the calibration tests. In making tests of a new type of gasoline depth gage it is advisable to investigate, in addition to the above characteristics, its behavior in flight or in a perturbed liquid.

Tests of pressure type gages.—The apparatus required for the testing of pressure type gages consists of a simple liquid manometer of large bore with suitable scale and with connections and valves to control the air pressure from a source of supply. The scale may be divided to read directly in inches of gasoline, or by the use of gasoline or liquid of equal specific gravity in the manometer the unmodified inch graduations may be used. In testing, the gage is connected with the manometer and the source of air supply. Various pressures are then applied and comparative indications of gage and manometer noted.

The temperature tests are conducted in a thermally insulated chamber equipped with heating and refrigerating coils by means of which the temperature may be varied as desired. Vibration tests are made by mounting the instruments upon a board which is caused to vibrate by an electric motor mounted thereon and with an unbalanced weight upon its shaft. By varying the motor speed the frequency of vibration may be changed and brought to approximately that which the instrument would experience when installed on aircraft. Additional tests which require no explanation will be noted in the report below. This specimen report will afford an understanding of the various tests, and the results will give a notion as to the performance of gages of the aneroid type.

REPORT ON TWO ANEROID TYPE GASOLINE DEPTH GAGES.

Calibration test.—The two gages were calibrated at 22°C, -3°C, +50°C, and also at room temperature before and after being subjected to vibration, repeated stress, and over pressure. In each case the pressures corresponding to a series of scale readings were determined, with increasing pressures to full scale deflection and immediately afterwards with decreasing pressure back to zero.

Numerical results, additive corrections computed for gasoline of specific gravity 0.68, are given in the following tables and the accompanying graphs:

INSTRUMENT No. 13.

Observed reading, inches of gasoline.	Correction at 22° C., reading—		Correction at -3° C., reading—		Correction at 50° C., reading—	
	Up (1).	Down (2).	Up (3).	Down (4).	Up (5).	Down (6).
0.....	-1.2	-1.2	-0.8	-1.2	+0.1	-0.5
5.....	-0.4	-0.5	-0.3	-0.4	+0.7	-0.2
10.....	-0.4	-0.5	-0.1	+0.5	+0.8	-0.2
15.....	-0.2	-0.5	0	+0.4	+0.5	-0.6
20.....	+0.2	-0.3	+0.5	+1.1	+0.6	-0.1
25.....	+0.5	+0.1	+0.6	+1.3	+0.6	-0.3
30.....	+0.1	+1.1	+0.5	+1.2	+0.4	-0.5
35.....	+0.3	+0.4	+0.4	+1.4	-0.2	-0.5
40.....	0	0	+0.7	+0.7	-0.5	-0.5

INSTRUMENT No. 14.

Observed reading, inches of gasoline.	Correction at 22° C., reading—		Correction at -3° C., reading—		Correction at 50° C., reading—	
	Up (1).	Down (2).	Up (3).	Down (4).	Up (5).	Down (6).
0.....	-0.6	-0.5	-0.8	-0.3	-0.1	-0.2
5.....	-0.1	-0.4	-0.1	-0.2	+0.8	+0.1
10.....	+0.3	+0.1	+0.8	+0.4	+1.1	+0.4
15.....	+0.7	+0.6	+0.5	+0.9	+0.9	+0.1
20.....	+0.9	+0.6	+0.7	+1.1	+0.8	+0.1
25.....	+0.8	+0.4	+0.6	+0.9	+0.6	-0.1
30.....	+1.0	+0.7	+0.7	+1.4	+0.4	-0.4
35.....	+0.4	+0.2	+0.4	+1.4	-0.1	-0.4
40.....	-0.7	-0.7	+0.8	+0.8	-0.2	-0.2

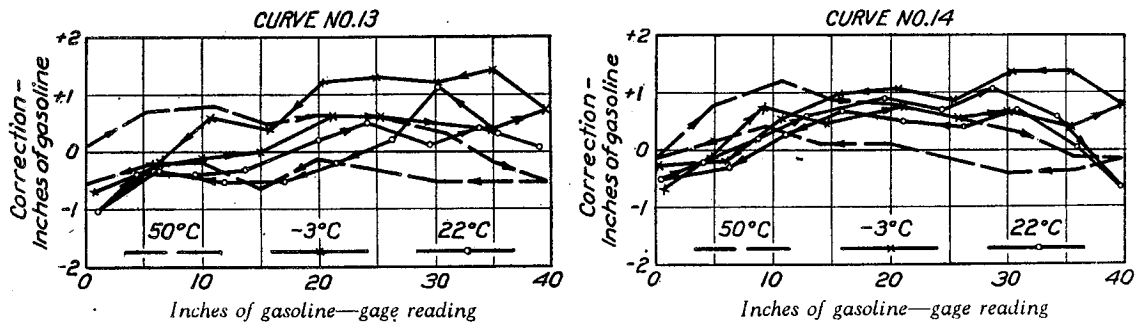

FIG. 5.—Calibration curves for aneroid gasoline depth gages. Temperature tests.

Friction test.—Readings taken with and without tapping with the dials of the instruments vertical showed the following differences:

Instrument Nos.	Differences, inches of gasoline.
13.....	0.0 to 0.7
14.....	0.0 to 0.6

Both gages were slightly irregular in action, but not sufficiently so to warrant rejection.

Inclination test.—The differences of readings taken with the dials first horizontal and then vertical for a series of pressures up to full scale deflection were as follows:

Instrument Nos.	Differences, inches of gasoline.
13.....	0.2 to 0.9
14.....	0.0 to 0.3

Drift and fatigue test.—The error caused by the elastic fatigue of the diaphragms under continuous pressure was determined by maintaining the instruments at a constant pressure equivalent to a scale reading of 20 for five and one-half hours. The drift or increase in readings at this pressure was as follows:

Instrument Nos.	Drift, inches of gasoline.
13.....	+0.9
14.....	+0.9

After subjection to 500 successive applications of a pressure equivalent to half scale deflection, the calibration varied from previous values by not more than 0.7 inch of gasoline in any case. Instrument No. 14 showed after this test an increase in the error of approximately 0.2 inch of gasoline throughout the scale.

Effect of vibration.—The effect of vibration was determined by calibrating the instruments before and after vibration for 18 hours on a machine which simulated the vibrations experienced in an airplane in flight. In general, a slight increase in the errors which reached a maximum of 0.9 inch of gasoline was obtained (see plots). The pointer of No. 13 vibrated excessively—from four to five divisions.

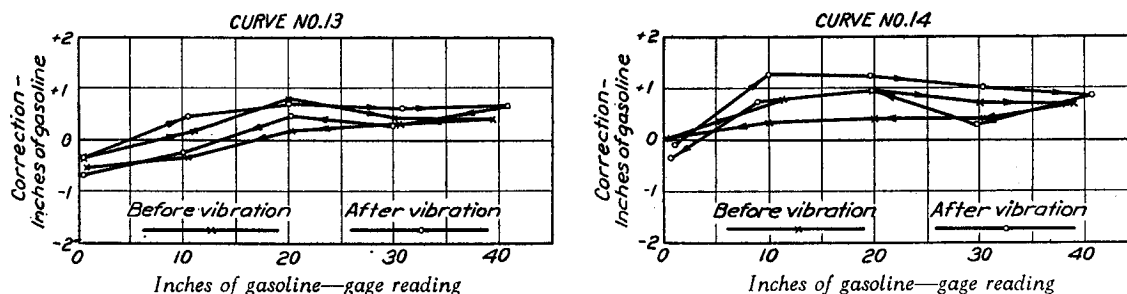

FIG.—6.—Calibration curves for aneroid gasoline depth gages. Vibration tests. (Room temperature.)

Excess pressure test.—The calibrations of the instruments before and after subjection to a momentary pressure of twice the maximum scale value differed in no case by more than 0.4 inch of gasoline.

FLOWMETERS.

In connection with performance tests of aircraft engines it is necessary that the rate of fuel flow be ascertained. It is also often desirable that similar indications be available to the aviator during long flights. Several types of instruments have been designed for this purpose and the following description refers briefly to two typical ones.

SCHROEDER FLOWMETER. (ECONOMETER.)

The instrument shown assembled and disassembled at the right of figs. 7 and 8 is the flowmeter developed by Maj. R. W. Schroeder, of the United States Air Service. The base casting is designed so that the inlet pipe from the fuel reservoir connects directly to the vertical meter tube threaded into the base and held concentrically within a surrounding tube of glass. The latter is firmly held in place upon a cork nonleak gasket seat in the base casting by means of a screw cap threaded at the top of the meter tube and extending over the glass. The cap is also provided with a gasket to make the joint free from leaks. A small adjustable screw threaded centrally into the cap and with hollow shank connecting with the atmosphere through a small radial hole is provided at the top for venting the meter.

The inner vertical tube to which the feed line is connected has an inside diameter of approximately $9\frac{1}{2}$ millimeters and a narrow longitudinal flow-controlling slit cut at one side to allow the entering liquid to flow from it into the annular space included between the inner and outer tubes. From this annular space the gasoline passes through the exit opening in the base and thence to the motor.

A light brass plunger fitting loosely in the central tube has mounted upon it an index pointer extending through the slit and moving over a vertical scale as the flow varies. This scale is fastened to the front flat milled surface of the tube. When the meter is in action the gasoline flowing into the main tube exerts a force upon the lower surface of the plunger sufficient to overcome its weight and thus lifts it to a definite position in the tube. The height to which it rises depends directly upon the rate of flow.

The instrument shown in the illustration weighs 575 grams and has an over-all height of approximately 160 millimeters. The glass tube has an internal diameter of approximately 26 millimeters.

R. A. E. MARK II FLOWMETER.

The instrument shown assembled and disassembled at the left of figures 7 and 8 is the flowmeter developed by the Royal Aircraft Establishment, of Farnborough, England. It is of the vane type and gives indications of rate of flow between the limits of 5 and 30 gallons per hour. Its action may be described as follows:

The gasoline from the fuel reservoir enters the meter case through a two-way valve which may be turned so as to by-pass the gasoline when, for any reason such as breakage of the meter, this procedure becomes desirable. Referring to the detail illustration at the left of figure 8 a fixed guide or baffle plate is seen projecting from the circumference of the case to the center. The gasoline enters the meter through an opening directly at the right of this guide plate and leaves it through an exit opening directly at the left of the guide. In passing from the entrance to the exit side the gasoline impinges upon the surface of a movable vane mounted upon the central pointer spindle. Sufficient clearance is left between the vane and the surrounding parts to allow the liquid to pass, but in so doing it exerts sufficient force upon the vane to move it through a certain angle, the magnitude of which depends upon the amount of flow. A helical coiled spring holds the pointer with the required force against the action of flow.

Inasmuch as the displacement of the vane does not bear a linear relation to the rate of flow when a leakage space of constant area is left around the vane, it is necessary to provide means for compensating for this characteristic. This is effected by having the space between the side wall and the end of the vane vary in depth, thus varying the leakage area at the vane extremity. When the pointer is at its minimum indication the vane occupies a position directly opposite the entrance opening. At this position the space between the wall and the end of the vane is

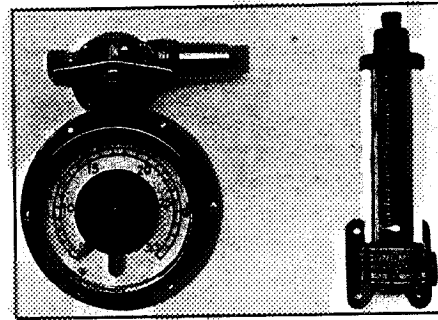

FIG. 7.—Flowmeters—Assembled.

Reproduced from
best available copy.

smallest. From this position it increases uniformly to a point opposite the exit opening, thus giving the instrument a uniform scale. The cover-glass is held in place by a bezel ring, which clamps it tightly against a nonleakable gasket joint at the case rim.

The vane described above has a length from center to end of approximately 36 millimeters and a depth of $13\frac{1}{2}$ millimeters. The wall surrounding the vane has a maximum height of 15 millimeters, an inside diameter of 74 millimeters and an outside diameter of 80 millimeters. The case has an outside diameter of 90 millimeters and depth of approximately 34 millimeters. The instrument complete weighs about 1 kilogram.

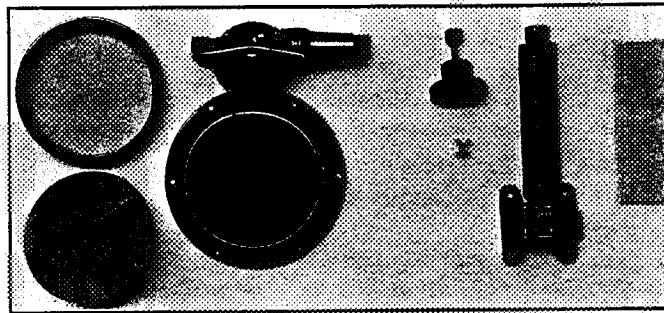

FIG. 8.—Flowmeters—Disassembled.

An older form of flowmeter designed and used in Great Britain consisted of a suitably mounted vertical glass tube through which the gasoline flowed. The tube was ground internally so that the inner surface was conical and with the smaller end at the bottom. A phosphor-bronze ball within the tube assumed a position of equilibrium at a height where the rate of flow through the annular space between the ball and the walls of the tube was such that the upward force on the ball was equal to the weight of the latter in gasoline. The scale fitted beside the glass tube was graduated experimentally to show the different rates of flow. A by-pass valve was provided so that the gasoline could be diverted from the tube in case of breakage.

○

Reproduced from
best available copy.

