

6693

NACA TN 3406

0066468



TECH LIBRARY KAFB, NM

NATIONAL ADVISORY COMMITTEE FOR AERONAUTICS

TECHNICAL NOTE 3406

A SELF-EXCITED, ALTERNATING-CURRENT, CONSTANT-
TEMPERATURE HOT-WIRE ANEMOMETER

By Charles E. Shepard

Lewis Flight Propulsion Laboratory
Cleveland, Ohio



Washington

April 1955

AFM-C
TECHNICAL LIBRARY
AFL 2811

W
NATIONAL ADVISORY COMMITTEE FOR AERONAUTICS

TECHNICAL NOTE 3406

A SELF-EXCITED, ALTERNATING-CURRENT, CONSTANT-TEMPERATURE

HOT-WIRE ANEMOMETER

By Charles E. Shepard

SUMMARY

The hot-wire anemometer described herein was used to study turbojet-engine compressor rotating stall and surge. The system was capable of measuring flow over a frequency range of zero to 500 cycles per second. A self-sustaining, 8-kilocycle-per-second oscillation was used to heat the wire in a constant-temperature system. The relatively rugged, large-diameter wire allowed the use of the anemometer during the full-scale performance testing of compressors and turbojet engines. The commercial audio-frequency amplifier used reduced the cost and the time required to build the anemometer.

INTRODUCTION

The anemometer described in this report was developed for compressor stall and surge indication during the performance tests of compressors and turbojet engines. The principal requirement was the ability to follow large-scale flow fluctuations at frequencies up to 500 cycles per second. Other important specifications were reliability and ease of operation. Although specifically designed to measure stall and surge, the anemometer also proved useful for other applications where the upper frequency limit was not high and where long wire life was necessary.

References 1 and 2 explain the superiority of the constant-temperature anemometer over the constant-current anemometer for high-amplitude flow fluctuations. Flow changes produce simultaneous wire time-constant changes. These changes of time constant with flow variations do not produce any difficulties in the constant-temperature system; however, in the constant-current system serious error in the indicated flow may result if the flow changes are large.

An improved model of the Ossofsky constant-temperature anemometer (ref. 3) has been used extensively at the Lewis laboratory for studies

of various nonsteady flow phenomena, such as compressor rotating stall, blade wake fluctuations, and turbulence (ref. 4). The chief limitation of this Ossofsky anemometer is the short service life of the small diameter wires when the operating conditions are not ideal. The maximum heating current is about 150 milliamperes, which is adequate only for the 0.00015- to 0.0004-inch-diameter wires; these wires are too fragile for many stall and surge measurements.

The requirement of an upper frequency limit of no more than 500 cycles per second for routine compressor-stall studies has permitted development of a simpler constant-temperature anemometer capable of heating a relatively rugged 0.001-inch-diameter wire. A carrier type of operation, utilizing a commercial audio-frequency amplifier, is used. The operation of this anemometer is relatively simple; the only operational control necessary is an on-off power switch.

The alternating current used for heating the wire is produced by a self-excited oscillation of the entire loop composed of amplifier, bridge (including the hot-wire), and transformers. A similar type of self-excited system, operating at about 1.5 megacycles per second and utilizing a specially developed amplifier, was described by Weske in an unpublished memorandum in 1949. The present design operates at about 8 kilocycles per second and thereby allows the use of a commercial audio-frequency amplifier.

THEORY

The simplified heat-transfer equation for the hot wire is

$$I_w^2 R_w = \pi D L H (\bar{T}_w - T_e) + \frac{\pi}{4} D^2 L \rho_w c_w \frac{d\bar{T}_w}{dt} \quad (1)$$

(All symbols are defined in appendix A; see appendix B, eq. (B3), for derivation of eq. (1).) For constant-temperature operation, $d\bar{T}_w/dt$ is zero and the heating current varies as the square root of the heat-transfer coefficient. As discussed in appendix B, various formulas are available to express the heat-transfer coefficient or the Nusselt number in terms of the air flow (refs. 4 and 5). For low velocity flow at constant density, Kings's equation (6) (ref. 6) may suffice. For jet-engine compressor studies, however, the Reynolds number or the mass-flow rate, together with parameters related to the density or Mach number, are used to define the heat loss (ref. 7). A useful approximation for a constant-temperature anemometer is that the heating current varies as the fourth root of the mass-flow rate.

Principle of operation. - The block diagram of the self-excited, alternating-current, constant-temperature anemometer is shown in figure 1. The system includes an audio-frequency amplifier that supplies

electric power to a resistance bridge. This bridge contains the hot wire whose resistance is a function of its temperature. The temperature of the wire is fixed by the balance between the amount of electric power supplied to it by the amplifier and by the cooling effect of air flowing past the wire. The bridge unbalance voltage, which is a function of the hot-wire temperature and the hot-wire current, is stepped up by a transformer and applied to the amplifier input.

The bridge is adjusted so that it will be balanced when the wire is at a "balance temperature" T_b which is higher than the air effective temperature T_e . The electric circuit is arranged to give regenerative feedback when the wire temperature is less than T_b . When the amplifier is connected, a self-induced oscillation occurs at a high audio frequency. As the wire, which is heated by the alternating current, approaches the balance temperature, the bridge unbalance voltage decreases until a stable point is reached where the unbalance voltage is just large enough to provide the heating current to keep the average wire temperature \bar{T}_w near to, but less than T_b . As the gain of the amplifier is increased, the difference between T_b and \bar{T}_w decreases. The expression for the temperature difference is derived in appendix C.

Advantages of a-c system. - The audio-frequency heating current permits the use of transformers and an a-c amplifier. The amplifier output transformer efficiently delivers the amplifier power to the hot-wire bridge. The fact that a commercial audio-frequency amplifier can be used greatly reduces the cost of the anemometer system.

The amplifier input transformer reduces the amount of amplifier gain required and improves the signal-to-noise ratio of the system, since the voltage gain obtained by matching the low bridge impedance to the high amplifier input impedance is achieved without the addition of noise.

Oscillation frequency. - The frequency of oscillation is determined by the frequency response of the entire loop, which includes amplifier, bridge, transformers, cables, and the hot-wire probe. The oscillation will occur at a frequency where the phase shift is zero, or some multiple of 360° , since these values correspond to regenerative feedback. Under the conditions of sustained oscillation, an over-all voltage gain of unity exists. In the self-excited, constant-temperature anemometer, the amount of bridge unbalance will be that value which is associated with an over-all voltage gain of unity.

System instabilities leading to wire burn-out. - The voltage gain and phase shift of the system largely determine the stability of the system. In order to study the stability, assume that the wire is heated

beyond the balance temperature; this corresponds to a phase shift of 180° . When this shift occurs, the feedback becomes degenerative at the frequency where oscillation existed and the oscillation will cease or will change to a new frequency where regenerative feedback can exist with the wire too hot. The operation then becomes very unstable; the small increase in wire temperature results in a larger input signal to the amplifier that causes additional heat to be supplied to the wire which further increases its temperature. In order to prevent this instability, which usually burns out the wire, the system must be designed so that the gain is low at the frequencies where the phase shift with the wire unheated is 180° or some odd multiple of 180° .

Reactive bridge unbalance is another potential source of instability since the unbalance voltage of the bridge will not approach zero as the wire temperature approaches the balance temperature. If the reactive unbalance is too large, the heating current may continue to increase, since the minimum unbalance voltage may be too large to limit the current.

Time response and stability of the system. - The constant-temperature mode of operation inherently produces an appreciable improvement in the response rate over the uncompensated constant-current mode. From equation (1) it can be seen that, if the temperature were kept at exactly the same value, the heat-storage term would vanish and the heating current would follow without lag variations in the air flow. If the gain of the system is high and the electrical lags of the system are small, the changes in wire temperature are very small, and the anemometer is able to follow rapid changes in flow. The extent to which this is accomplished is determined by the gain, and is limited by the fact that stability is impaired when the gain is made too high. (The response time of the hot-wire anemometer described in this report is about one-fortieth that of an uncompensated bare-wire anemometer.)

DESCRIPTION OF ANEMOMETER

General description. - Figure 2 is a photograph of the self-excited, constant-temperature anemometer. The panel voltmeter reads the average voltage appearing at the output terminals. These terminals also supply signals to the cathode-ray oscilloscope for dynamic measurements. A calibration curve is furnished, relating this voltage to air-flow rate for a given probe design.

Figure 3 shows the wiring diagram. The important components and wiring techniques are described in the following paragraphs.

Wire. - The hot-wire material used is 72-percent nickel - 28-percent iron alloy that combines high specific resistivity (20 micro-ohm cm which is twice that of iron) with a high temperature coefficient of resistivity ($\alpha = 0.0029/^{\circ}\text{F}$). The high resistance reduces effects of changes in support resistance. A high-temperature coefficient of resistivity reduces the amount of amplifier gain required for a given difference between the balance and operating temperatures.

A 0.10-inch length of 1-mil diameter wire is used. This length-to-diameter ratio yields an end-conduction effect of about 20 percent at a Mach number of 0.1. This value is calculated from data in references 7 and 8. Since the conduction effect is included in the original calibration of the wire, the presence of this effect produces no serious errors.

Probe. - The hot-wire is mounted on a probe as shown in figure 4. The small probe diameter in the vicinity of the wire permits measurements in compressors without excessive flow blockage; for the radial-type of mounting, the wire will be normal to the axial and tangential components of flow for axial-flow compressors. This configuration renders the wire insensitive to flow angle for the principal flow. Since the wire can be considered to respond only to the component of flow normal to the wire (over an angle range of about $\pm 65^{\circ}$), the alternate wire mounting shown in figure 4 is also useful. Here the wire is mounted normal to the axial flow but parallel to the tangential flow for axial-flow compressors. This configuration permits the measurement of the axial component of flow when radial flow is neglected.

Current and potential leads are provided so that the effect of the resistance of all but a short length of the supporting prongs can be minimized by proper bridge design.

Three-wire bridge connection. - The bridge consists of the hot wire, (3-ohm balance resistor) corresponding to a balance temperature of 700°F , and two 15-ohm ratio-arm resistors. The low resistance of the wire necessitates a bridge connection that will compensate for the lead resistance; in addition, the reactive balance must also be maintained. The major source of reactive unbalance is the cable inductance. The three-wire Siemens connection shown in figure 5 provides both resistive and inductive compensation for the cable since it, in effect, places one of the leads on each leg of the bridge. When this arrangement is used, cable length can be changed from zero to 50 feet without appreciable effect on the bridge balance.

Bridge isolation transformer. - The transformer that connects the bridge output to the amplifier input must isolate the bridge output from the ground to avoid shunting of one arm and a resulting shift in bridge balance. For this reason, a high-quality bridge transformer having a very low unbalanced capacitance to ground was used. A voltage gain of 4 was obtained; this reduced the amount of amplifier gain

required. The transformer has a good high-frequency response so that the phase lag, which would affect the stability, is small. The transformer specifications are:

Primary turns	60
Secondary turns	240
Frequency range, ± 6 decibels, cps	2000 to 500,000
Primary to secondary capacitance, μmf	0.3

Amplifier. - The amplifier used is a slightly modified commercial 10-watt audio amplifier. The modification consists of (a) replacement of the output transformer by one having a better frequency response, and (b) increase of degenerative feedback from the output transformer to the second-amplifier stage to provide a more acceptable amplitude ratio - phase-shift diagram. The modified amplifier has the following specifications:

Input impedance, megohms	5
Output impedance, ohms	2
Voltage gain, maximum	130
Equivalent input noise level, μv	50
Frequency response, ± 3 decibels, cps	100 to 60,000
Rated output power, watts	10

Complete circuit. - The major individual components of the circuit have been discussed in the previous sections. The over-all assembly is shown in figure 3. The resistor-capacitor combination (located at the amplifier input) and the coupling capacitor in the bridge supply circuit are a low-pass and a high-pass filter, respectively. These filters provide the proper drop in amplitude as the frequency varies from the normal operating value. There is also a shunt which gives a voltage proportional to the heating current. The meter-type rectifier and conventional filter circuit provide the d-c output voltage.

The electrical performance of the assembled components is tested by determining the circuit open-loop frequency response. The circuit is opened at the bridge output and a signal is inserted at the bridge isolation transformer. The hot wire is replaced by a fixed resistor whose value gives an over-all voltage gain of approximately unity at the nominal operating frequency. Figure 6 shows typical polar plots of the ratio of the bridge unbalance voltage to the open-loop input signal and the phase shift between these two voltages for various cable lengths. The resistor-capacitor combination at the amplifier input and the coupling capacitor in the bridge supply circuit are adjusted to set the oscillation (zero phase shift) frequency.

Examination of figure 6 also shows the adverse effect of cable length on the frequency response. A cable length of greater than about

25 feet is a source of instability. For example, for a 100-foot cable length, more gain is available at 180° phase shift than at the normal zero-phase-shift operating point. For this condition, a relatively small disturbance can cause a shift from the stable to the unstable point. This shift can cause wire burn-out.

DYNAMIC CHARACTERISTICS

Methods of determining dynamic response. - The dynamic response of the system has been determined experimentally in three ways:

- (1) By the introduction of a small step change in the bridge balance point by means of the circuit of figure 7(a).
- (2) By the introduction of a small step change in heating current by means of the circuit of figure 7(b).
- (3) By exposing the wire to a large-amplitude step change in air flow by use of the shock-tube arrangement shown in figure 8.

Simulated and actual flow changes. - Methods 1 and 2 provide a sudden unbalance, which the system seeks to eliminate. A high-speed relay, driven at 60 cycles per second, is used to produce these changes. These disturbances, if they are small, can be used to simulate a flow change, and hence, to determine the response of the system to small flow changes. The shock tube is used to determine the response to a flow change from zero to a relatively high value of mass-flow rate. In this method, a Cellophane diaphragm, inserted in a tube of constant area, forms two chambers, which are kept at different pressures. When the diaphragm is ruptured, a shock wave travels down the tube at approximately sonic speed. The wave front, which becomes very sharp as it progresses, separates a region of zero air flow from a region of relatively high air flow. When the wire is at a right angle with the flow, the time taken for the shock to pass the wire is negligible. Although the wave travels at about the speed of sound, the air velocity immediately behind the wave front is subsonic. There are numerous reflections and a temperature discontinuity front which, in time, modify the air flow; however, the dimensions of the shock tube were chosen so that a rectangular pulse of about 10-milliseconds duration having negligible rise time was available to check the anemometer response. Reference 9 gives a more complete analysis of the shock tube and tabulates the parameters needed to calculate the mass-flow rate.

Comparison of methods. - Figure 9 shows the time response of the system as determined by methods 1, 2, and 3 for a final flow rate of 20 pounds per square foot per second and for a voltage gain of 40. The photographs of figure 9 show the output voltage of the anemometer together with a 1000-cycles-per-second timing trace. The output voltage is obtained from the rectified and filtered current-shunt voltage drop; except for the slight nonlinearity of the rectifier, the amplitude of the output voltage is proportional to the heating current.

The three methods yield essentially the same time history of response to a step change. In each case there is a damped oscillation superimposed on the exponential change. The effective time constant of the system is that value of time at which the change is 63 percent of its final value; in figure 9 it is about 0.6 millisecond. Methods 1 and 2 offer a convenient means of determining the character of the response and can be justified by their agreement with method 3.

Effect of gain on dynamic response. - For a given system, the dynamic response is largely determined by the voltage gain of the system and by the wire time constant. The shock tube method is used in figure 10 to show the effect of voltage gain at a constant value of wire time constant. The final flow rate produced by the shock tube is about 20 pounds per square foot per second. Overshoot, optimum response, and undershoot can be produced by small changes in voltage gain. The improvement in speed of dynamic response over the uncompensated constant current system is approximately equal to the voltage gain for low values of voltage gain. For higher values of gain, the overshoot imposes an upper limit on the improvement in response. A moderate amount of overshoot appears to give the best response rate; the frequency of the damped oscillation of the overshoot ranges from 600 cycles per second at zero air-flow rate to about 1200 cycles per second at very high flow rates.

Effect of wire time constant on dynamic response. - For a given wire size and material, the wire time constant varies inversely with the Nusselt number, or approximately inversely as the square root of the mass-flow rate. Figure 11 shows this effect, using method 1 of figure 7(a), on the amount of overshoot and on the rapidity of decay of the damped oscillation. If a voltage gain of 50 and a flow of 60 pounds per square foot per second, corresponding to a time constant of 0.01 second are used, there is no overshoot; at the same gain but with lower flows of 20 and 5 pounds per square foot per second, corresponding to wire time constants of 0.02 and 0.03 second, respectively, an increasing amount of overshoot occurs.

Optimum gain setting. - At any flow, and therefore at any wire time constant, there is a gain setting that gives a relatively fast response rate with an acceptably small amount of overshoot. Fortunately, the range of gain settings is small for a wide range of flows so that good response can be obtained with a single gain setting. A voltage gain of about 40 is actually used.

STATIC CHARACTERISTICS

Wire temperature. - The wire temperature is calculated from equation (B4) of appendix B and is plotted in figure 12 as a function of the voltage gain of the system. In the range of gains that are actually used, the wire temperature is reasonably independent of the gain. For a voltage gain of 40 and a balance temperature of 700° F, the wire temperature was 640° F.

Flow calibration. - The anemometer was calibrated experimentally to give the output voltage as a function of mass-flow rate. Figure 13 shows this calibration. The calibration is valid for measurements up to the usable upper frequency limit, as determined experimentally. A voltage gain of 40 was used.

OPERATION AND PERFORMANCE

Auxiliary equipment. - Reference 4 describes the auxiliary equipment and the techniques used for various hot-wire applications. For compressor rotating stall, an oscilloscope is ordinarily used to record the flow pattern and an audio-frequency oscillator is used to determine the fundamental stall frequency by forming Lissajous figures. Determining the number of rotating-stall segments requires the use of two anemometers. The two probes are mounted at the same compressor station but are spaced at a known angle. If there is only one segment of stalled flow, the electrical phase angle between the two patterns will be the same as the mechanical spacing. For an n -segment stall the electrical phase angle would be n times that of the probe spacing.

Effect of anemometer dynamic response on oscilloscope patterns of rotating stall. - The dependence of the anemometer response time on the air flow may result in a certain amount of distortion in the output voltage pattern if the fundamental stall frequency is high. For example, at an air flow of 40 pounds per square foot per second, the effective time constant of the system is about 0.3 millisecond; this corresponds to an upper frequency limit (-3 decibels) of about 500 cycles per second. At a flow of 5 pounds per square foot per second, the upper frequency limit is about 250 cycles per second. If the fundamental component of stall frequency is, for example, 150 cycles per second, there may be a noticeable lag in the response during the low flow part of the stall pattern. This limitation is not a fundamental fault of a self-excited, constant-temperature anemometer system and can be corrected by using a smaller diameter wire, if the application permits.

Wire service life. - The four factors that affect wire life are: (a) aerodynamic loading and shock, (b) bombardment by foreign particles in the air stream, (c) mechanical damage during handling and mounting, (d) vibration effects. Reference 7 discusses some of these problems in detail.

The wire of the length and diameter used in this anemometer is adequately strong for the usual compressor aerodynamic loads. However, wire breakage may occur under very severe conditions such as the periodic passing of a strong shock wave past the wire. Reducing the length-to-diameter ratio will improve the strength for aerodynamic loads, but will result in larger "end losses."

The impingement of particles on the wire at high velocity will cause very high stresses. Wire breakage can be reduced by increasing the diameter to reduce the magnitude of the stress, by reducing the wire length to reduce the probability of hits, or by use of a material having a higher yield point in tension. The effect of these changes would be either an increase in time constant, an increase in "end losses," or the loss of certain desirable electrical characteristics. If the particle happens to be a liquid droplet (such as oil or water) there is the additional effect of a sudden change in the effective heat-transfer coefficient. This change may disturb the operation of the anemometer enough to cause wire burn-out.

Mechanical damage to the hot-wire probes has been minimized by a protective sleeve kept over the wire during handling and storage. The mechanical strength of the wire is high, so that wire breakage is rare during mounting in the typical application. The effects of vibration have not been systematically investigated for the present wire configuration.

With a reasonably clean air supply, wire service life has ranged from 2 to 6 hours, with an average of 4 hours.

CONCLUDING REMARKS

A simple inexpensive constant-temperature, hot-wire anemometer has been described that can be used by personnel who have not been specially trained in hot-wire anemometry. In actual operation it has proven to be a practical instrument for the measurement of compressor rotating stall. One limitation of the performance of this anemometer is the somewhat limited speed of response at low flow which may, if the fundamental stall frequency is high, cause some distortion of the stall pattern. In a typical rotating-stall application, where the air is reasonably clean, a wire service life of about 2 to 6 hours can be expected with an average life of about 4 hours.

Lewis Flight Propulsion Laboratory
National Advisory Committee for Aeronautics
Cleveland, Ohio, January 12, 1955

APPENDIX A

SYMBOLS

The following symbols are used in this report:

A	voltage gain, E_s/E_u
a	surface area of wire
c	specific heat
D	wire diameter
E	rms value of voltage
f	frequency
G	mass-flow rate
H	heat-transfer coefficient
I	rms value of current
k	thermal conductivity of air
L	wire length
M	Mach number
Nu	Nusselt number, DH/k
Pr	Prandtl number evaluated at film temperature
p	static pressure
R	resistance
Re	Reynolds number, DG/μ
T	temperature
t	time
V	volume

- α temperature coefficient of resistance at effective temperature
- λ mean free path
- μ absolute viscosity
- ρ specific density

Subscripts:

- b condition at which bridge is balanced
- e effective, with reference to temperature attained by unheated body in air stream
- f mean film value, based on arithmetic mean of object and effective temperature
- p pressure
- r bridge ratio arms
- s bridge supply
- u bridge unbalance
- w wire
- O amplifier output

Superscript:

- average value over 1/2 cycle of oscillation

APPENDIX B

RELATION BETWEEN AIR FLOW AND HEATING CURRENT

The approximate expression for the heating current as a function of the air flow can be obtained by writing the heat-transfer-rate equation in which radiation and conduction losses are neglected:

$$[\sqrt{2} I_w \sin(2\pi ft)]^2 R_w = aH (T_w - T_e) + V_w c_w \rho_w \frac{dT_w}{dt} \quad (B1)$$

For a wire of circular cross-section

$$I_w^2 [1 - \cos(4\pi ft)] R_w = \pi DLH (T_w - T_e) + \frac{\pi}{4} D^2 L c_w \rho_w \frac{dT_w}{dt} \quad (B2)$$

If the frequency f of the heating current is high compared with the upper frequency limit of the anemometer, the cosine term can be neglected:

$$I_w^2 R_w = \pi DLH (\bar{T}_w - T_e) + \frac{\pi}{4} D^2 L c_w \rho_w \frac{d\bar{T}_w}{dt} \quad (B3)$$

where \bar{T}_w is the average temperature over the period $1/4\pi f$. In terms of the Nusselt number,

$$I_w^2 R_w = \pi Lk Nu (\bar{T}_w - T_e) + \frac{\pi}{4} D^2 L c_w \rho_w \frac{d\bar{T}_w}{dt} \quad (B4)$$

If only the steady-state response is required, the heat-storage term involving the time derivative can be omitted. For constant temperature operation of a hot-wire anemometer in a steady air flow of constant temperature, the current is given by:

$$I_w = \sqrt{\frac{\pi Lk (\bar{T}_w - T_e)}{R_w}} \sqrt{Nu} \quad (B5)$$

Several expressions for the relation between Nusselt number and Reynolds number are to be found in the literature (refs. 4 and 5). Reference 4 gives

$$Nu = 0.19 + 0.52 Re^{0.5} \quad (B6)$$

where the Prandtl number is taken to be 0.72. Reference 5 gives

$$Nu = 0.32 + 0.43 Re^{0.52} \quad (B7)$$

At higher mass-flow rates, equations of this form become inaccurate and an additional parameter must be used to define the Nusselt number. This parameter may conveniently be taken to be either the Mach number, or the ratio of wire diameter to the mean free path D/λ (proportional to Re/M); in general, at a given Reynolds number, the Nusselt number reaches a minimum at about a Mach number of 1.0. An experimentally determined plot of Nusselt number against Reynolds number in reference 7 shows the effect of Mach number.

APPENDIX C

WIRE TEMPERATURE CALCULATIONS

When the effect of cable impedance is neglected, the open-circuit bridge unbalance voltage (fig. 5) in terms of the amplifier output current is

$$E_u = \frac{R_b - \bar{R}_w}{2 + \frac{R_b + \bar{R}_w}{R_r}} I_0 \quad (C1)$$

where it is assumed that the wire resistance is constant over the period $1/(4\pi f)$. But

$$E_s = I_0 \frac{(R_b + \bar{R}_w) 2R_r}{R_b + \bar{R}_w + 2R_r} \quad (C2)$$

and

$$E_s/E_u = A$$

Combining equations (C1) and (C2) and solving for $(R_b - \bar{R}_w)$ yields

$$R_b - \bar{R}_w = \frac{4R_b}{A + 2} \quad (C3)$$

In terms of effective temperature,

$$T_b - \bar{T}_w = \frac{4R_b}{\alpha R_e (A + 2)} \quad (C4)$$

where R_e is the wire resistance at air effective temperature.

REFERENCES

1. Ziegler, M.: The Construction of a Hot Wire Anemometer with Linear Scale and Negligible Lag. *Verhandelingen d. Koninklijke Akademie v. Wetenschappen (Amsterdam)*, vol. XV, no. 1, 1934.
2. Weske, John R.: A Hot-Wire Circuit with Very Small Time Lag. NACA TN 881, 1943.

3. Ossofsky, Eli: Constant Temperature Operation of the Hot-Wire Anemometer at High Frequency. Rev. Sci. Instr., vol. 19, no. 12, Dec. 1948, pp. 881-889.
4. Laurence, James C., and Landes, L. Gene: Auxiliary Equipment and Techniques for Adapting the Constant-Temperature Hot-Wire Anemometer to Specific Problems in Air-Flow Measurements. NACA TN 2843, 1952.
5. McAdams, William H.: Heat Transmission. Second ed., McGraw-Hill Book Co., Inc., 1942.
6. King, Louis Vessot: On the Convection of Heat from Small Cylinders in a Stream of Fluid: Determination of the Convection Constants of Small Platinum Wires with Applications to Hot-Wire Anemometry. Proc. Roy. Soc. (London), ser. A, vol. 214, no. 14, Nov. 1914, pp. 373-432.
7. Lowell, Herman H.: Design and Applications of Hot-Wire Anemometers for Steady-State Measurements at Transonic and Supersonic Airspeeds. NACA TN 2117, 1950.
8. Scadron, Marvin D., and Warshawsky, Isidore: Experimental Determination of Time Constants and Nusselt Numbers for Bare-Wire Thermocouples in High-Velocity Air Streams and Analytic Approximation of Conduction and Radiation Errors. NACA TN 2599, 1952.
9. Huber, Paul W., Fitton, Cliff E., Jr., and Delpino, F.: Experimental Investigation of Moving Pressure Disturbances and Shock Waves and Correlation with One-Dimensional Unsteady-Flow Theory. NACA TN 1903, 1949.

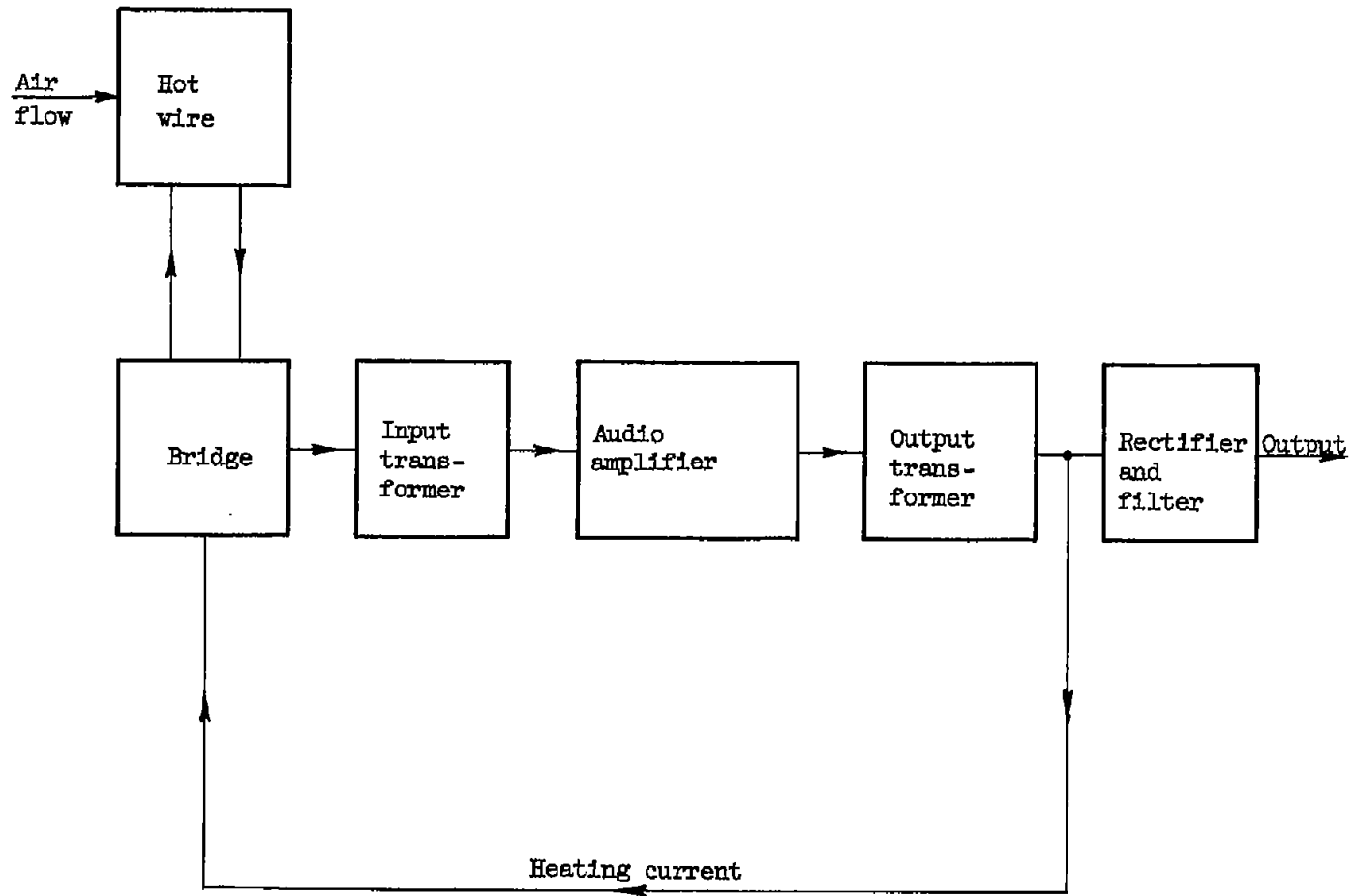

Figure 1. - Block diagram of self-excited, alternating-current, constant-temperature anemometer system.

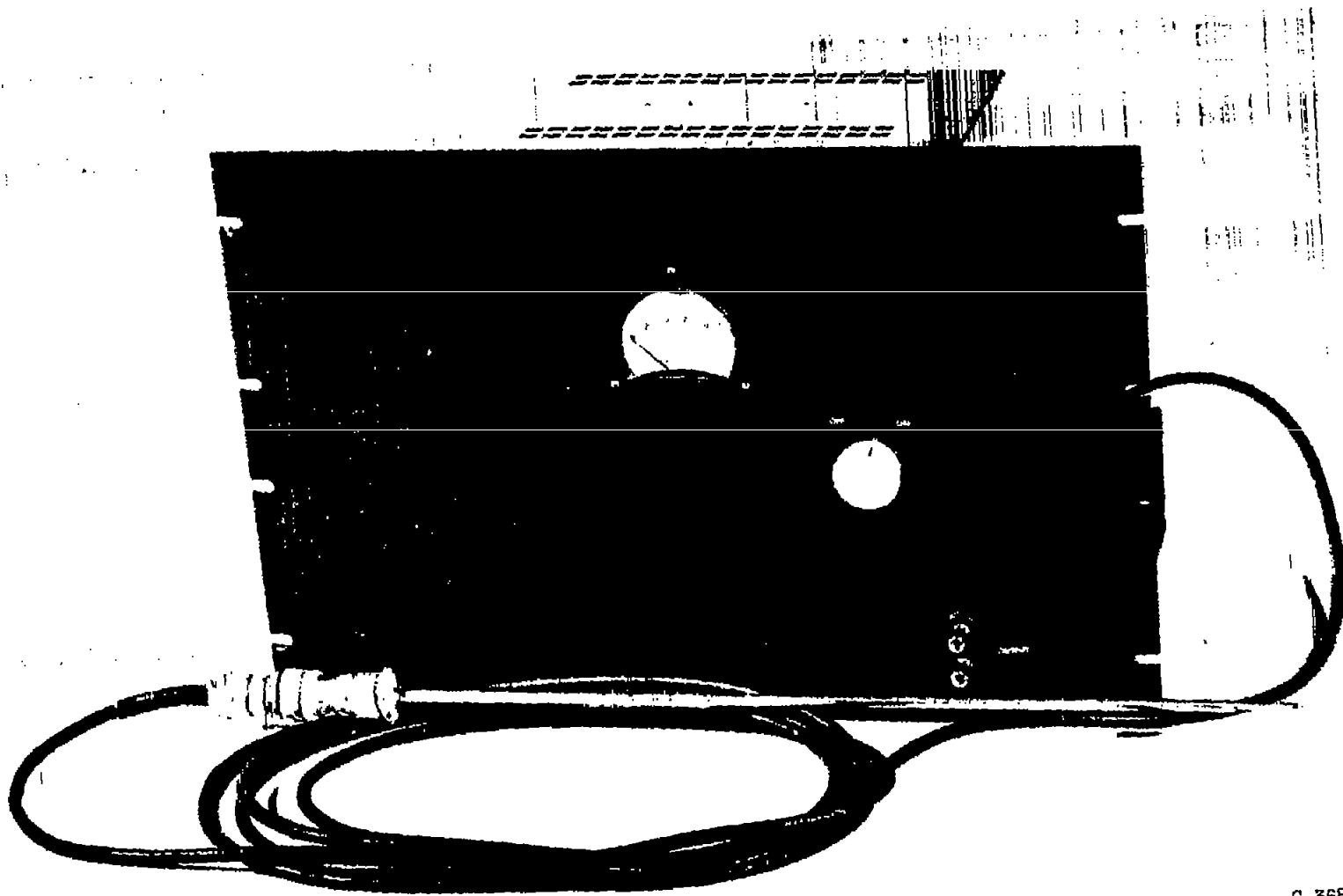
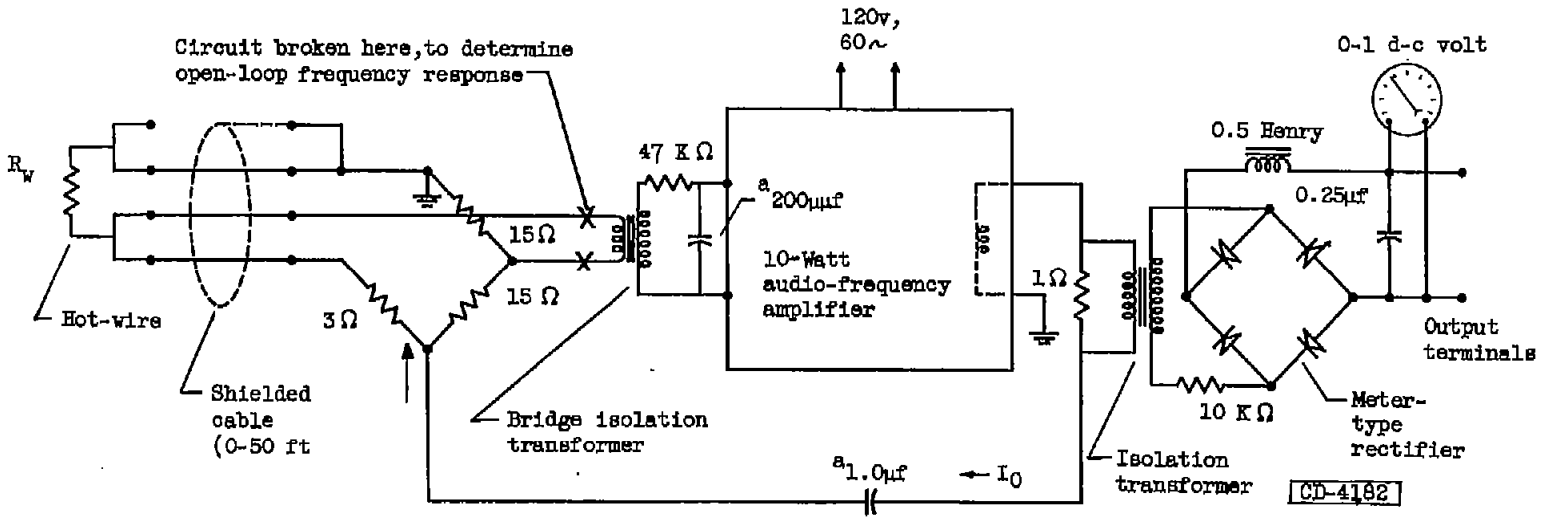

Figure 2. - Self-excited, constant-temperature, hot-wire anemometer.

C-36839

NACA FM 3406



^a These values may be changed to adjust oscillation frequency.

Figure 4. - Wiring diagram of self-excited constant-temperature anemometer.

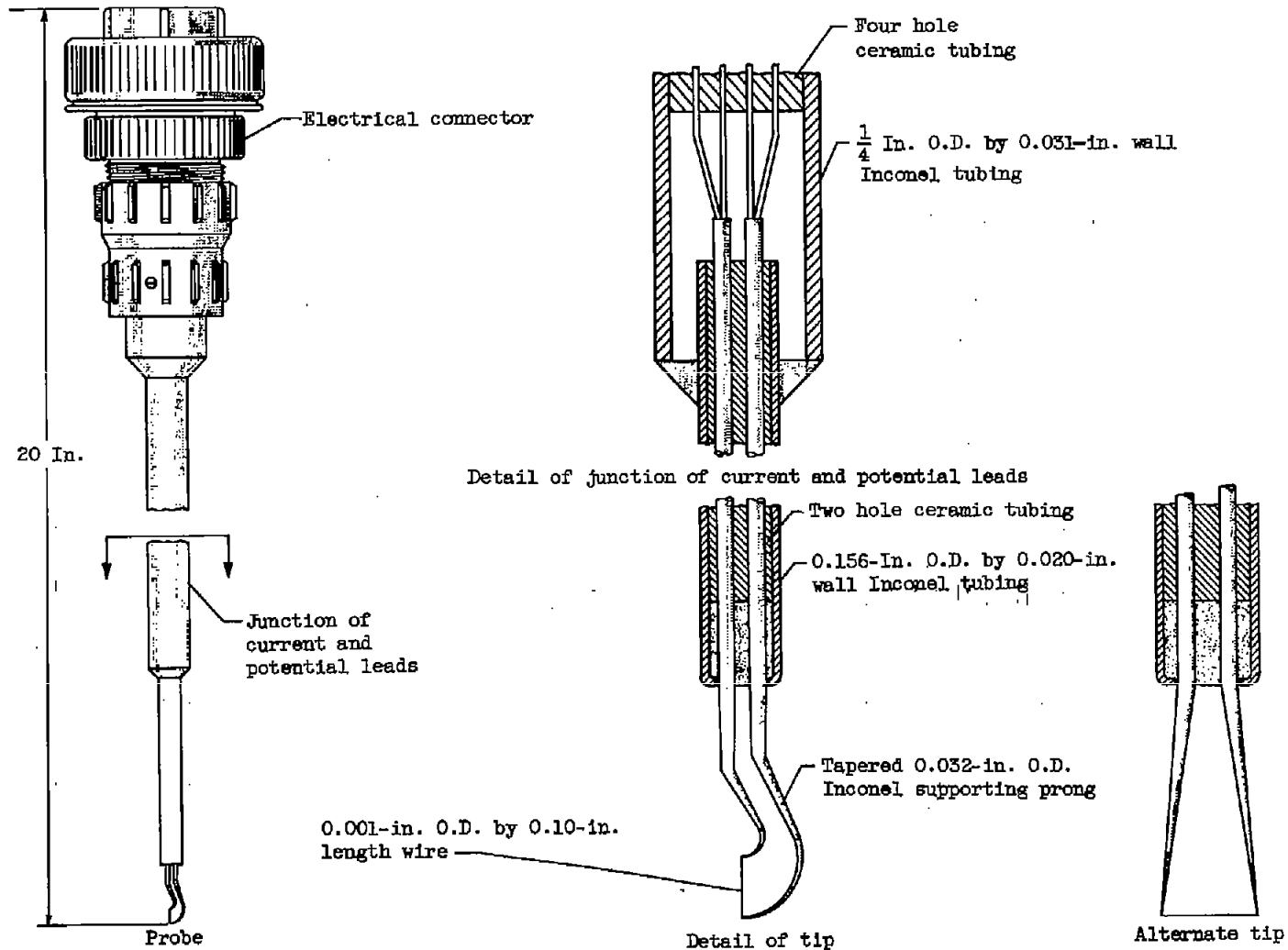

Figure 4. - Hot-wire anemometer probe.

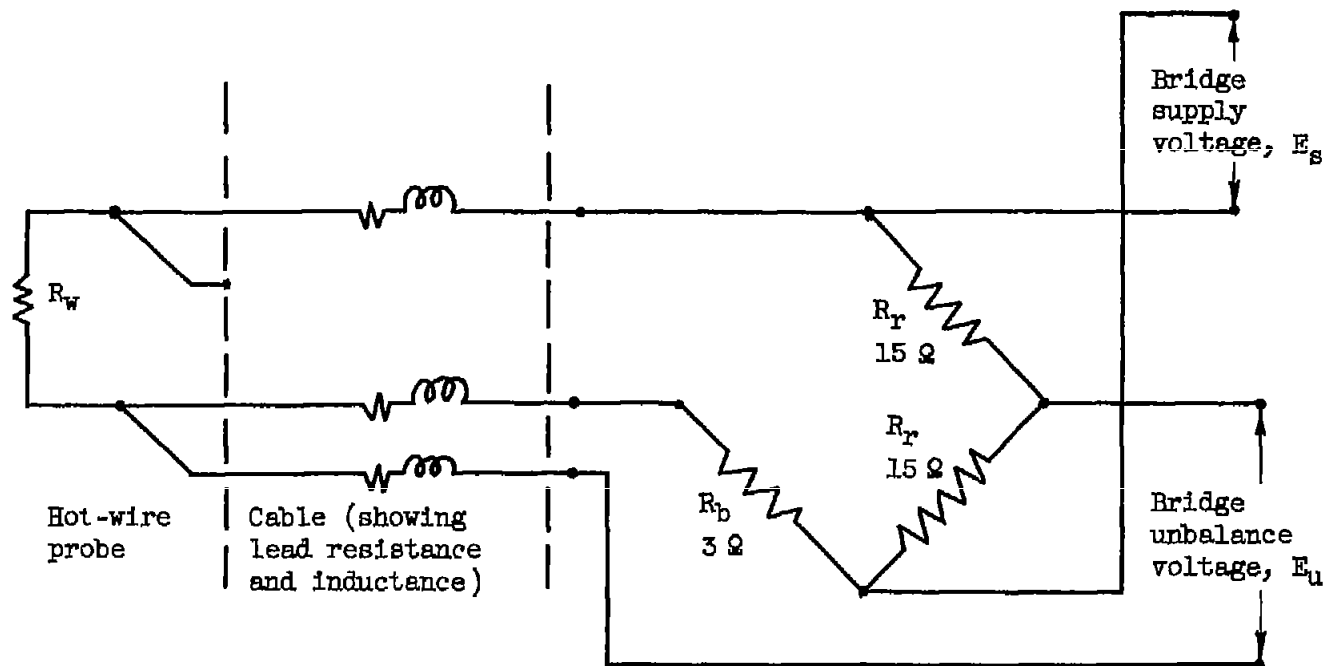

Figure 5. - Three-wire (Siemens) bridge connection. Bridge resistors shown are precision and noninductive (deposited film type).

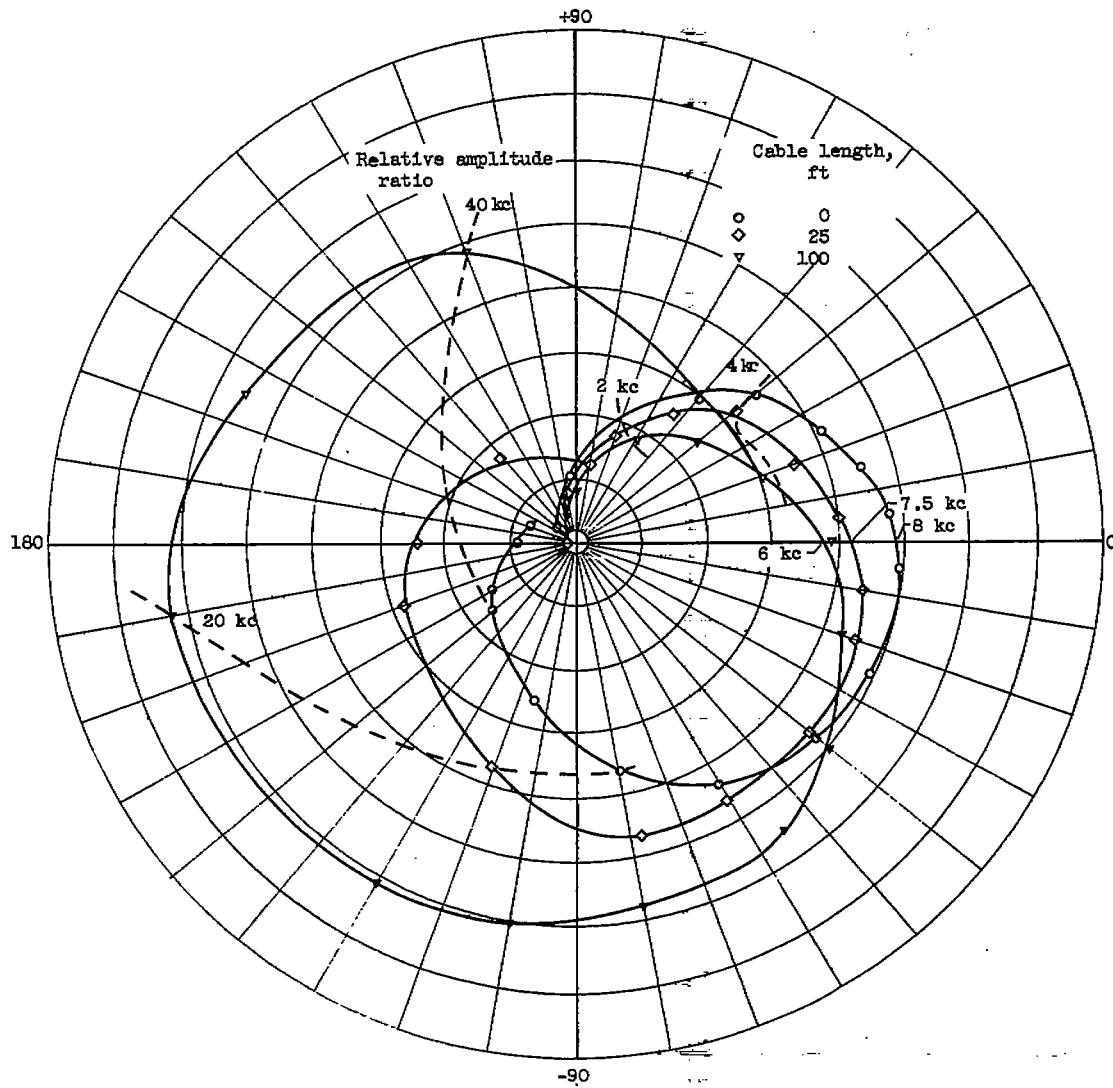
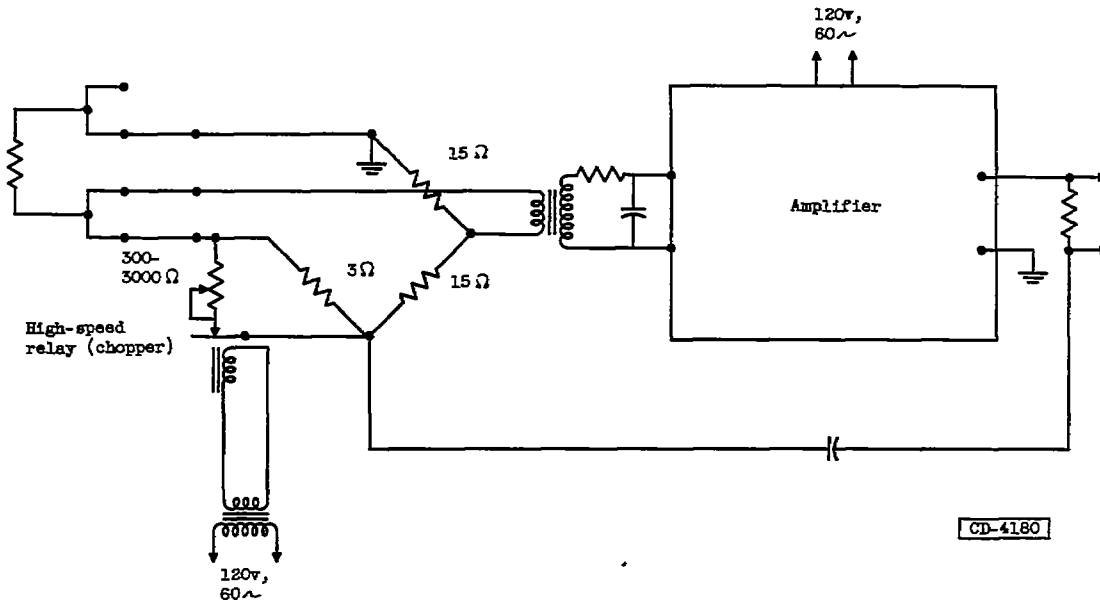
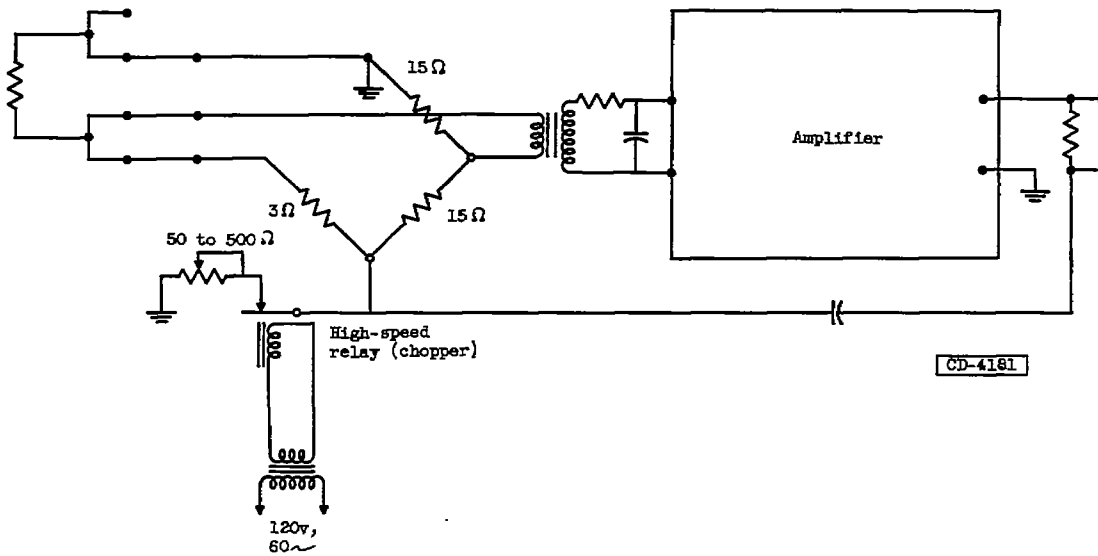

Figure 6. - Amplitude ratio - phase-shift diagrams for various cable lengths.



(a) Determination of response by varying bridge balance.



(b) Determination of response by varying output current.

Figure 7. - Determination of response by simulated flow changes.

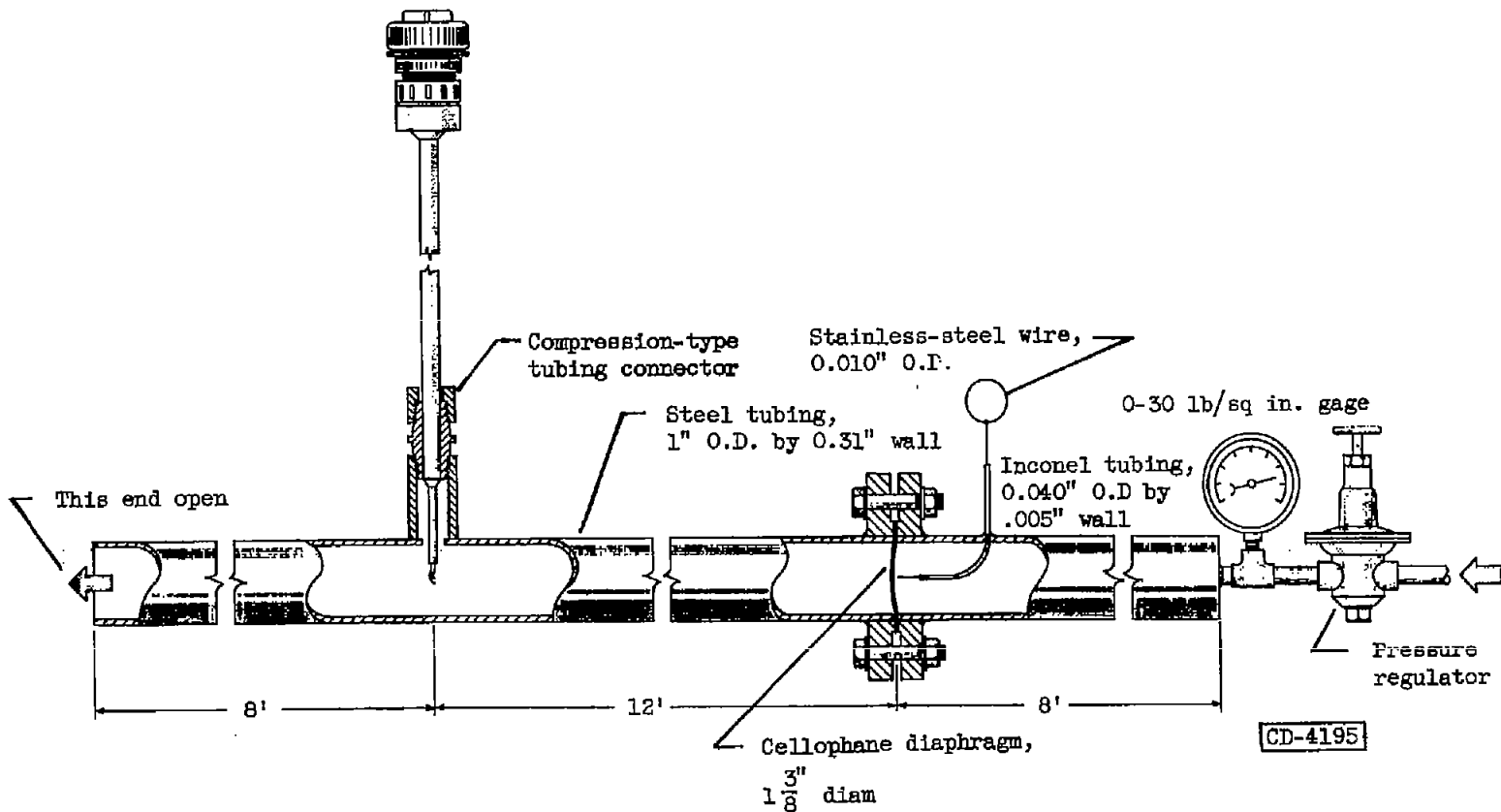
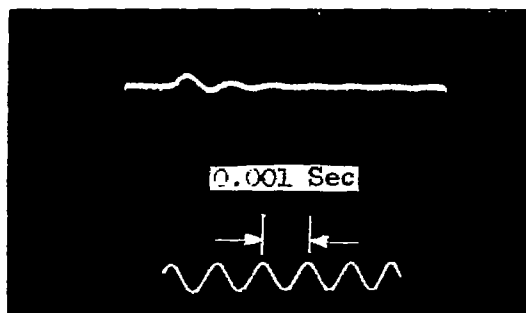
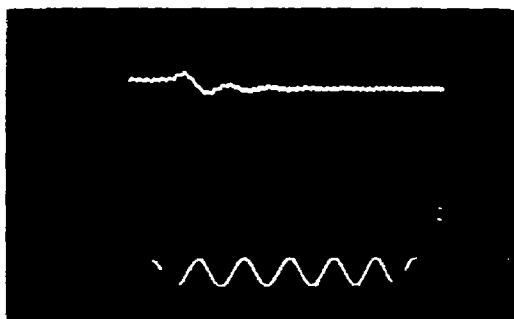

Figure 8. - Shock tube for determination of hot-wire anemometer response.



(a) Simulation of flow change by changing bridge balance point. 1-Percent change in flow rate simulated.



(b) Simulation of flow change by changing heating current. 1-Percent change in flow rate simulated.

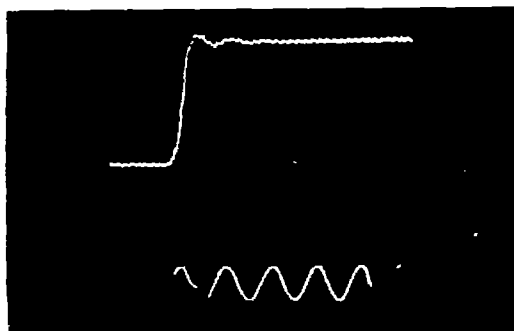

C-37416

Time →

(c) Change in flow introduced by shock tube.

Figure 9. - Oscillograms of three methods of determining anemometer response. Final flow rate, 20 pounds per square foot per second; voltage gain, 40.

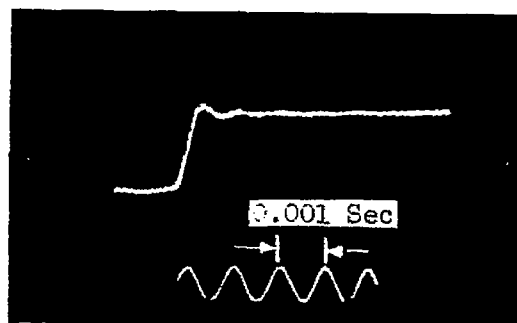

(a) Voltage gain, 50.

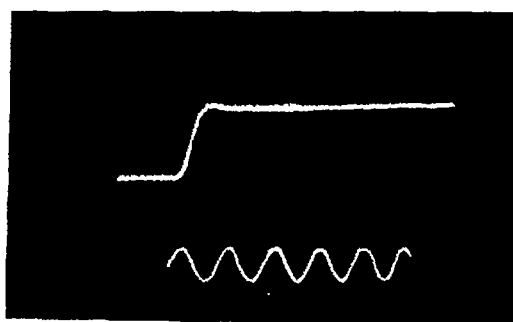

(b) Voltage gain, 40.

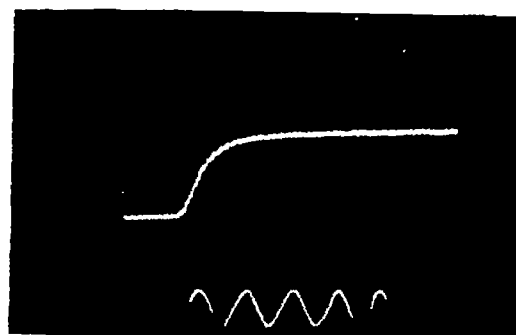

Time →

(c) Voltage gain, 30.

C-37417

Figure 10. - Effect of gain of system on dynamic response of anemometer.
Final flow rate, 20 pounds per square foot per second.

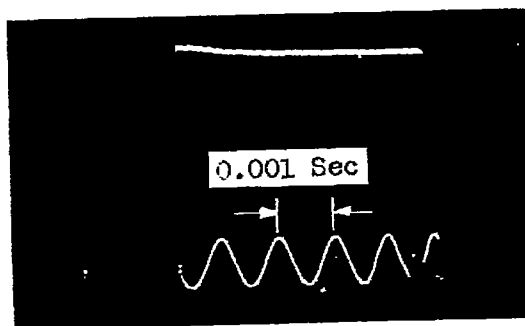

(a) High flow rate, 60 pounds per square foot per second.

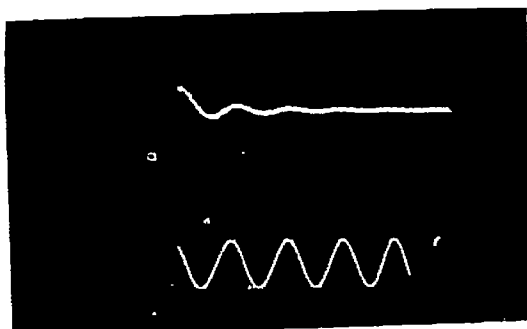

(b) Moderate flow rate, 20 pounds per square foot per second.

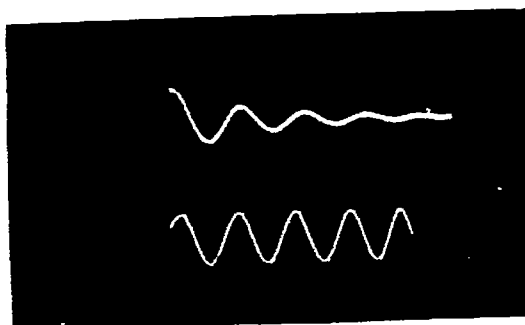

C-37418

Time →

(c) Low flow rate, 5 pounds per square foot per second.

Figure 11. - Effect of flow rate upon dynamic response. Simulated step change introduced by shunting bridge arm. Voltage gain, 50.

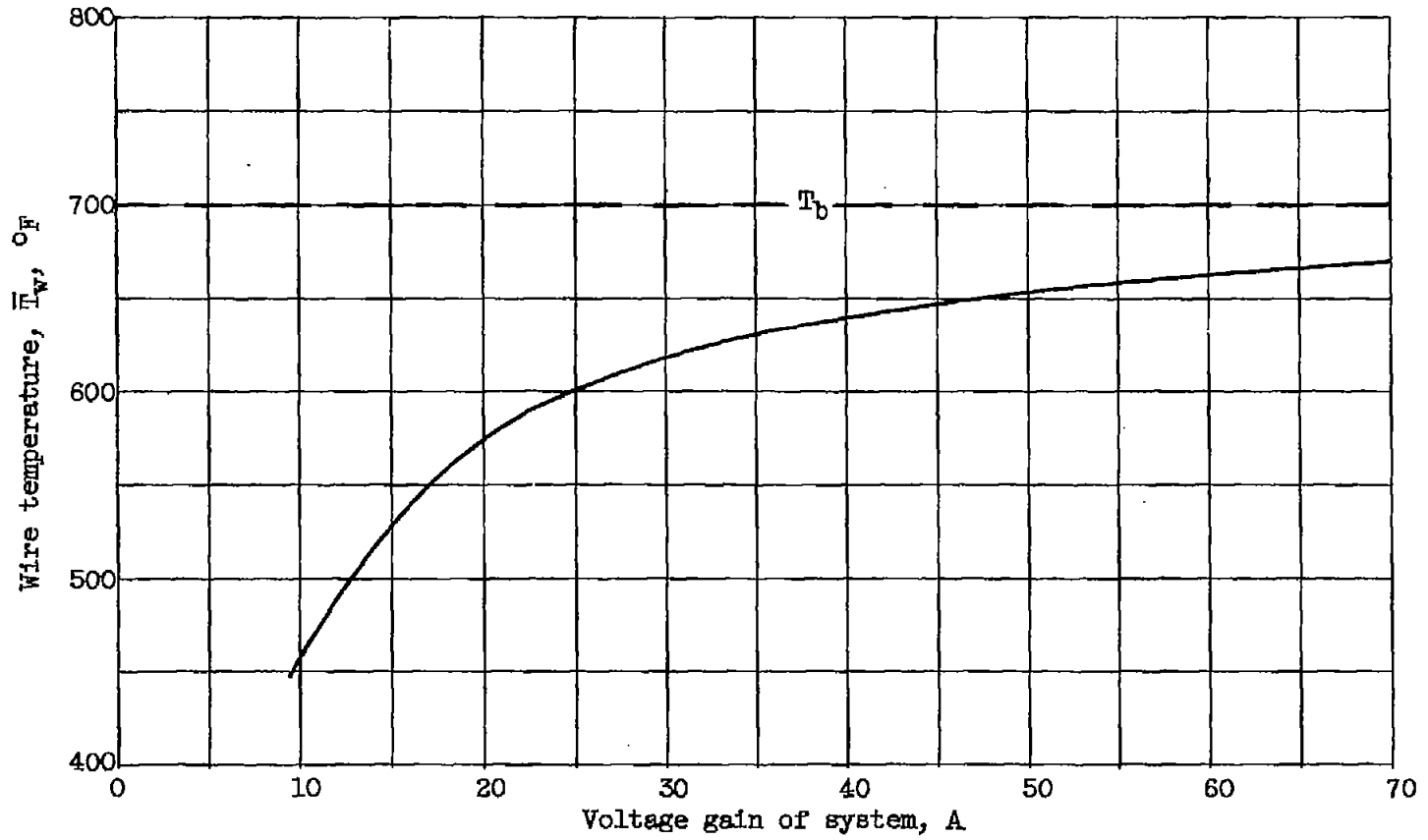

Figure 12. - Average wire temperature as function of voltage gain for balance temperature, 700° F.

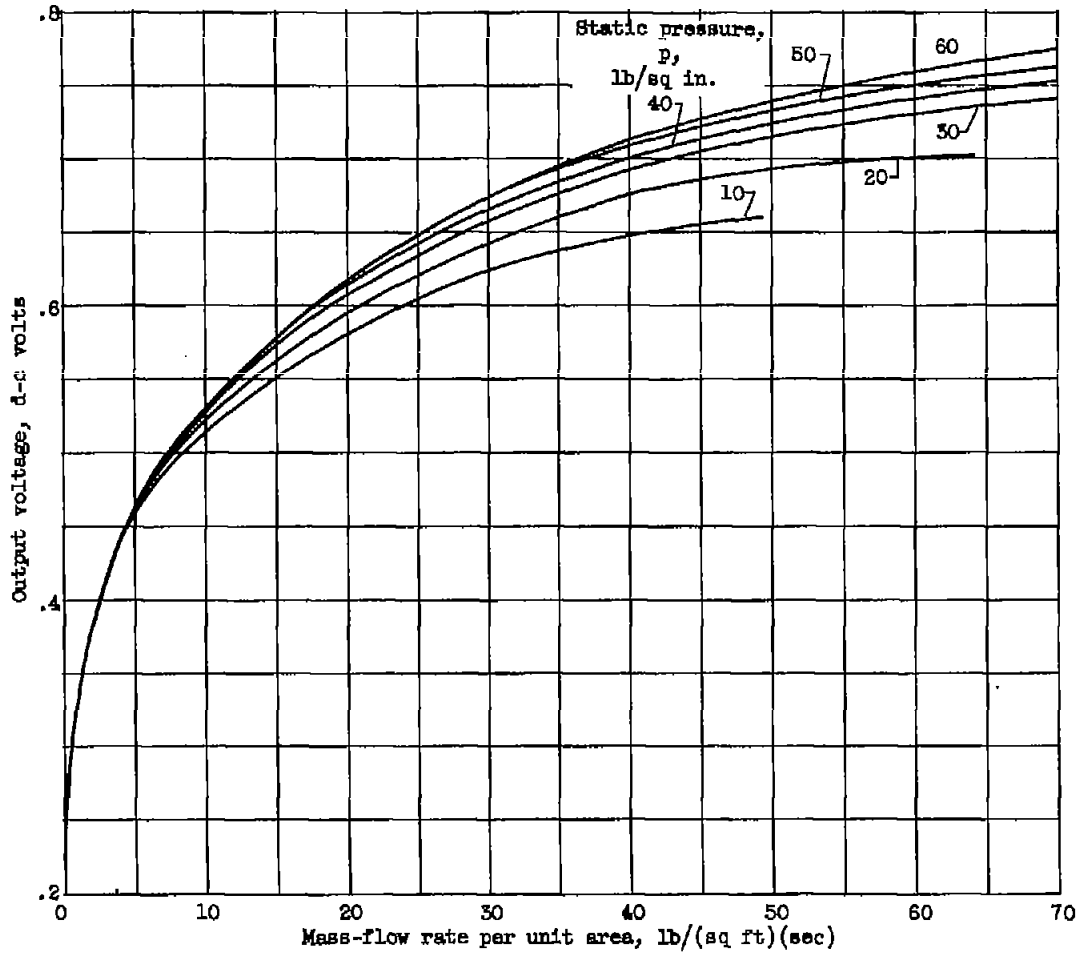

Figure 13. - Output voltage as a function of mass-flow rate for various static pressures.
Air total temperature, 75° F.