

U. S. DEPARTMENT OF COMMERCE

R. P. LAMONT, Secretary

BUREAU OF MINES

SCOTT TURNER, Director

Bulletin 357

SHAFT-SINKING PRACTICES AND COSTS

BY

E. D. GARDNER and J. FRED JOHNSON



UNITED STATES
GOVERNMENT PRINTING OFFICE
WASHINGTON: 1932

For sale by the Superintendent of Documents, Washington, D. C.

CONTENTS

| | Page | | Page |
|---|------|---|------|
| Introduction..... | 1 | Excavating shafts—Continued. | |
| Size, shape, and inclination of shafts..... | 1 | Sinking shafts—Continued. | |
| Size and shape..... | 1 | Methods of removing broken rock—Contd. | |
| Inclination..... | 4 | Shoveling into auxiliary pans..... | 40 |
| Mechanical equipment for shaft sinking..... | 4 | Loading buckets with mechanical scrapers..... | 44 |
| Sinking hoists..... | 4 | Dropping broken rock through borehole..... | 45 |
| Hoists for prospecting..... | 5 | Pumping..... | 45 |
| Hoists for sinking deep shafts..... | 5 | Water rings..... | 47 |
| Cables..... | 6 | Shaft ventilation..... | 47 |
| Hooks..... | 7 | Lighting..... | 48 |
| Crossheads..... | 7 | Shaft support..... | 48 |
| Headframes..... | 8 | Timber lining..... | 49 |
| Excavating shafts..... | 9 | Steel sets..... | 60 |
| Raising shafts..... | 12 | Guniting..... | 65 |
| Sinking shafts..... | 18 | Concrete linings..... | 66 |
| Crews..... | 19 | Guides..... | 82 |
| Routine..... | 20 | Sinking through running ground..... | 86 |
| Drilling..... | 21 | In rock in place..... | 86 |
| Drills..... | 21 | In surface sediments..... | 86 |
| Steel..... | 21 | Piling method..... | 87 |
| Collaring holes..... | 22 | Open-caisson method..... | 87 |
| Manifolds..... | 22 | Pneumatic-caisson method..... | 88 |
| Air and water lines..... | 23 | Sealing water out of shafts... Grouting..... | 88 |
| Hose..... | 23 | Grouting through shaft lining..... | 88 |
| Line oilers..... | 24 | Grouting ahead of sinking..... | 90 |
| Loading supplies in buckets..... | 24 | Sealing water from timbered shafts..... | 92 |
| Shaft rounds..... | 24 | Bonus for labor..... | 92 |
| Blasting..... | 30 | Sinking rates..... | 93 |
| Explosives..... | 30 | Cost of sinking shafts..... | 96 |
| Primers..... | 31 | Cost of concreting..... | 102 |
| Rotation of holes..... | 32 | Summary..... | 104 |
| Wiring rounds..... | 32 | Index..... | 105 |
| Amount of explosive per foot..... | 34 | | |
| Methods of removing broken rock..... | 34 | | |
| Shoveling into buckets or skips..... | 34 | | |

ILLUSTRATIONS

| Fig. | Page |
|---|------|
| 1. Cross section of United Verde No. 7 shaft..... | 2 |
| 2. Cross section of circular shaft..... | 3 |
| 3. Safety crosshead used in sinking Eureka shaft..... | 7 |
| 4. Pilot raise, No. 6 shaft, Morenci, Ariz..... | 13 |
| 5. Compressed-air injector used by Moctezuma Copper Co. for ventilating raises through diamond-drill holes..... | 14 |
| 6. Method of timbering shaft, Utah Copper Co..... | 19 |
| 7. Manifold for drills used at Magma mine..... | 22 |
| 8. Shaft round used at United Verde mine in medium ground..... | 25 |
| 9. Shaft round, Hecla mine..... | 26 |
| 10. Round used in Guadalupe shaft, Moctezuma Copper Co..... | 26 |
| 11. Shaft round used in easy-breaking ground at Morenci..... | 27 |
| 12. Round used in Froid No. 3 shaft..... | 28 |
| 13. Round used in McPherson shaft, Tennessee Copper Co..... | 28 |
| 14. Round for wet shaft of small cross section..... | 29 |
| 15. Round for shaft of small cross section..... | 29 |
| 16. Round used in Randfontein shaft..... | 29 |
| 17. Nineteen-cubic-foot sinking bucket..... | 35 |
| 18. Arrangement for dumping buckets at surface, used by the Walter Fitch, jr., Co., Eureka, Utah..... | 36 |
| 19. Arrangement for dumping buckets at Engels mine, California..... | 37 |
| 20. Arrangement for dumping bucket in inclined shaft..... | 38 |
| 21. Sinking skip used at Froid No. 3 shaft..... | 39 |
| 22. Arrangement for using auxiliary skip at Park Konold mine, Utah..... | 40 |
| 23. Details of cage used in sinking Guadalupe shaft..... | 41 |
| 24. Arrangement for dumping auxiliary pan into skip, North Star mine..... | 42 |
| 25. Skip for sinking combination vertical and inclined shaft..... | 43 |
| 26. Arrangement for sinking shafts at United Verde mine..... | 44 |
| 27. Arrangement of timbering and keyboard lagging, Eighty-Five mines..... | 51 |
| 28. Suspended bulkhead used for shaft sinking by Walter Fitch, jr., Co..... | 53 |
| 29. Shaft set, Magma mine..... | 55 |
| 30. Sets at South shaft, Teck-Hughes mine..... | 55 |
| 31. Standard shaft set, Black Rock mine, Butte & Superior Mining Co..... | 56 |
| 32. Sets at Argonaut inclined shaft..... | 56 |
| 33. Shaft timbering, Rock Springs mines Nos. 4 and 5, Union Pacific Coal Co., Wyoming..... | 57 |
| 34. Jacket set around cribbed shaft, Butte & Superior mine..... | 58 |
| 35. Steel shaft set..... | 61 |
| 36. Steel shaft set, Interior shaft, Santa Margarita mine, Cia. Real del Monte y Pachuca..... | 63 |
| 37. Combination concrete and gunite shaft lining..... | 66 |
| 38. Wooden forms for concreting shaft, used at Calumet and Arizona mine..... | 70 |
| 39. Steel forms with rounded ends for concreting Campbell shaft..... | 71 |
| 40. General shaft plans and standard reinforcement, Magma Copper Co..... | 73 |
| 41. Concrete lining, Chief Consolidated shaft..... | 75 |
| 42. Water rings in concreted coal-mine shaft..... | 78 |
| 43. Closure joints in concrete shaft..... | 78 |
| 44. Combination of concrete and steel sets for shaft lining..... | 79 |
| 45. Ring method of concreting shafts, United Verde Copper Co..... | 80 |
| 46. Precast cribbing used at Zaruma, Ecuador..... | 82 |
| 47. Bolt sockets for attaching guides, Campbell shaft..... | 84 |
| 48. Bolt sockets for attaching guides, skip compartment, No. 7 shaft, United Verde mine..... | 85 |
| 49. Section of shaft showing method of grouting ahead of sinking..... | 91 |

SHAFT-SINKING PRACTICES AND COSTS¹

By E. D. GARDNER² and J. FRED JOHNSON³

INTRODUCTION

This paper describing the methods of sinking shafts is one of a series on mining practices and costs being prepared by the United States Bureau of Mines. As with all mining operations, shaft-sinking practices vary in different fields according to custom. Different methods of sinking are, of course, necessary in specific instances because of variations in the depths and sizes of shafts, the material through which they are sunk, and the purpose they are to serve.

The best methods of performing all phases of shaft sinking are discussed herein, with particular attention to the practices at metal mines.

SIZE, SHAPE, AND INCLINATION OF SHAFTS

SIZE AND SHAPE

The cross section of a shaft is governed by the use to which the shaft is to be put and the material through which it will be sunk. Its size and the number of compartments should be such that the mine tonnage of ore or waste can be hoisted without difficulty in the time available and that men and supplies can be handled promptly. The time lost by men waiting to be hoisted or lowered at the beginning and end of a shift, waiting for cages to go from one level to another, or waiting for supplies before they can start working may be considerable in a year. Generally where such conditions exist the mine has outgrown the hoisting equipment. Ventilation is another important factor, particularly in hot mines. The shaft should be large enough to carry the amount of air required for adequate ventilation.

The present tendency in shaft practice at large metal mines is to provide compartments for skips holding up to 12 tons, depending on the tonnage handled, and one or two service compartments with cages large enough to hold one to four trucks of timber or other supplies on each of one or two decks. A considerable saving is effected by providing cages on which loaded trucks can be run, thus avoiding the handling of supplies by hand at the shaft. Whether such a cage compartment is justified depends, of course, on the size of the operation. An example of a shaft of large cross section is the No. 7 shaft

¹ Work on manuscript completed July, 1931.

² Supervising engineer, U. S. Bureau of Mines, Tucson, Ariz.

³ One of the consulting engineers, U. S. Bureau of Mines, and shaft and tunnel contractor, Eureka, Utah.

of the United Verde Copper Co., Jerome, Ariz. (fig. 1), now being sunk for hoisting 3,000 tons of ore per day and handling the men and supplies necessary to mine this tonnage. The ultimate depth of this shaft will be 5,000 feet.

The Froid No. 3 shaft of the International Nickel Co., Sudbury, Ontario,⁴ which is designed to handle 6,000 tons of ore per day, the men, and supplies, to a depth of 3,000 feet, is about the same size as the United Verde No. 7 shaft but is lined with timber. It is 16 by 28 feet 2 inches outside of timber and contains two 6 by 14 foot 4 inch cage compartments, two 6 by 6 foot skip compartments, a service cage compartment, and the usual ladder, pipe, and counterweight compartments.

The shaft of the Miami Copper Co., Miami, Ariz., through which 8,000 to 18,000 tons of ore per day have been hoisted since 1921, is

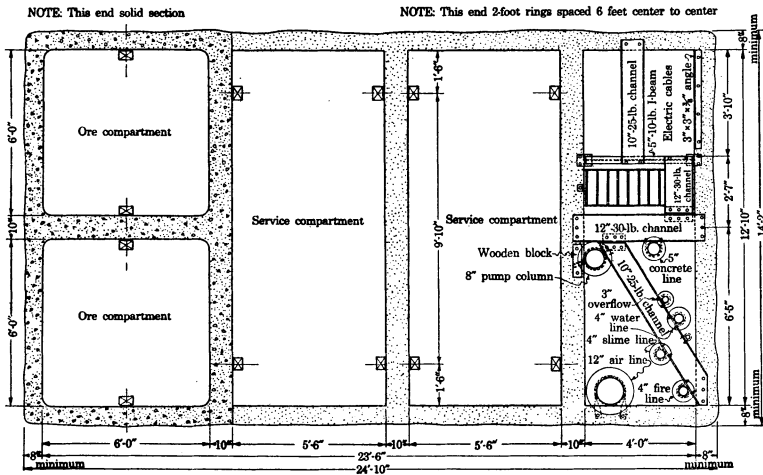

FIGURE 1.—Cross section of United Verde No. 7 shaft

of concrete construction, 13 by 16 feet 4 inches, inside dimensions. It contains one 6-foot 6-inch by 13-foot cage compartment, two 5-foot 6-inch by 6-foot skip compartments, manway, pipe, and counterweight compartments.

The recently sunk Campbell shaft of the Calumet and Arizona Mining Co., referred to later, is another example of shafts of large cross section.

Where a large tonnage is mined from a relatively shallow depth twin shafts may be used to advantage, as at the Inspiration Consolidated Copper Co.⁵ A normal tonnage of 900 tons per hour has been hoisted through these shafts, which have two 5-foot 6-inch by 6-foot skip compartments and a service compartment of the same size. A single shaft at the same property is capable of hoisting 600 tons per hour. This latter shaft has two 5-foot 6-inch by 5-foot 11-inch skip compartments and a 6-foot 9-inch by 12-foot 11-inch cage compartment.

⁴ Brock, A. F., Sinking Froid No. 3 Shaft: Eng. and Min. Jour., vol. 130, Nov. 10, 1930, p. 443.

⁵ Stoddard, Alfred C., Mining Practice and Methods at Inspiration Consolidated Copper Co., Inspiration, Ariz.: Inf. Circ. 6169, Bureau of Mines, 1929, 23 pp.

Where operations of a single company extend over a large area, as at Butte, a number of shafts of relatively small cross section may be used. Moreover, where heavy ground is to be expected a number of shafts of relatively small section may be used rather than fewer shafts of large section because of the difficulty of keeping the large shafts open.

Shafts with one 5 by 7 foot compartment are used in the Tri-State district. Two-compartment shafts are used in some districts, but the usual shaft for metal mines of small or moderate tonnage contains three compartments in a line. Two compartments are used for hoisting and the third for a ladderway and for pipes; a part of the third compartment may be used for a service or "chippy" cage. Cages are generally used below or above the skips for handling men or supplies. The skips may be replaced by cages for handling the shift. At small mines the ore usually is hoisted in cars on the cages, in which case no skips are used. Where a number of products are hoisted in the same shaft skips may not be practical.

Shafts for larger tonnages, particularly if sunk some time ago, generally contain four or five compartments in a row. A number of examples of shafts with the compartments in a row are shown later. Table 1 shows the section, number, and size of the compartment used in representative metal-mine shafts; it also gives the practices followed in sinking these shafts.

Round shafts are favored in some districts, particularly where water measures are penetrated. Apparently a circular section is better able to withstand the hydrostatic pressure without cracking where the water is sealed from the shaft. Circular shafts also have an advantage for ventilation purposes, as less resistance is offered the air currents than in rectangular shafts of the same section. Figure 2 shows a circular shaft.

Rectangular shafts usually are preferred for working shafts, as all of the cross section can be utilized and the cost of lining is less. At Butte shafts of an octagonal cross section are favored strictly for ventilation. Ventilation shafts should be smooth-lined to reduce the air resistance to a minimum.

Shafts at coal mines usually are of larger cross section than those in metal mines. Shafts up to 14 by 31 feet or larger, inside measurements, are used in large coal mines.⁶

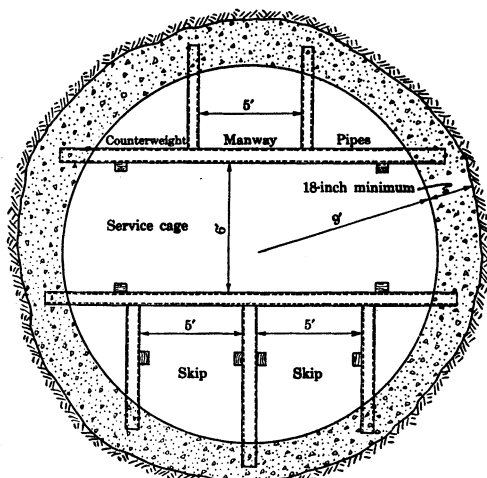

FIGURE 2.—Cross section of circular shaft

⁶ Herbert, C. A., and Young, C. M., Engineering Features of Modern Large Coal Mines in Illinois and Indiana: Trans. Am. Inst. Min. and Met. Eng., vol. 63, 1920, p. 813.

INCLINATION

An inclined shaft has the advantage of requiring less crosscutting to reach a vein at different levels, and it may be the most practical for mining relatively flat veins or beds. Another advantage with flat shafts is that trucks containing timber or other supplies can be run down the incline and off at the levels without rehandling the material. Vertical shafts, however, have so many advantages that they are now used at most places. A vertical shaft is easier to maintain in bad ground than an inclined shaft, as only side pressure must be withstood. Skips are more easily loaded in vertical shafts, and safety devices are more easily installed and surer in their action. Skips or cages running on tracks in a shaft cause vibration of the timbers, which tends to loosen the blocking of the sets. Greater speed of hoisting is possible in vertical shafts. Inclined shafts should not be steeper than 80°, as skips tend to jump the track at a greater pitch.

Both track and guides are used in steeply inclined shafts. In some districts vertical shafts have been continued downward as inclined shafts. This practice in new shafts, however, has been largely discontinued.

MECHANICAL EQUIPMENT FOR SHAFT SINKING

In isolated sections prospect shafts may be sunk by hand drilling up to 100 feet or even deeper and the broken rock hoisted by means of a hand windlass or horse whim. This method of sinking, however, is rarely used except in prospecting and is not discussed in this paper. For depths over 50 feet power hoists are more economical. Power is required for hoisting, for compressing air to operate drills, and for running ventilation blowers. Steam or gas engines are sometimes used for hoisting, but when new equipment is purchased and electric power is available, electrically driven hoists usually are installed. At operating metal mines compressed air generally is available for drilling. Sinking hoists may also be operated by compressed air. If air is not available, compressors must be installed; these usually are electrically driven. In isolated sections hoists and compressors for small operations are in most instances run by gas engines, although if local fuel is available, steam plants may be erected.

SINKING HOISTS

The hoisting equipment used governs in part the speed and cost of sinking shafts. The capacity of the hoist determines the size of the sinking bucket or skip that can be used and the rate of removal of the broken rock from the shaft. A sinking-hoist motor should be about 25 per cent stronger than one required for normal hoisting because it must be run slowly in sinking operations.

As lives depend directly on the working of the hoisting engine only one in good repair should be used. Hoists employed for sinking should be positively geared both for hoisting and lowering. Buckets should not be lowered on the brakes with the clutch disengaged.

For sinking prospecting shafts, winzes, or short lifts of main shafts a small hoist of low cost may be the most economical. For sinking deep shafts in one lift larger hoists give the lowest over-all sinking costs. Frequently a hoist suitable for sinking and for hoisting waste from lateral development will be purchased and a more powerful hoist installed when the mine is put on a production basis.

A small hoist has an advantage underground inasmuch as it can be installed with less excavating and can be moved from place to place with less expense. These factors are especially important where a number of shafts are sunk a lift at a time, one after another.

HOISTS FOR PROSPECTING

Small portable hoists with 10-cubic-foot buckets and $\frac{3}{8}$ -inch cable are frequently used for sinking prospecting shafts of small section. A compressed-air hoist suitable for such work can be purchased for about \$400 (December, 1930). Two shafts, one 185 feet and another 500 feet deep, were recently sunk in Arizona with such a hoist. A 10-hp. electric hoist capable of lifting 2,000 pounds at a rate of 124 feet per minute can be purchased for about \$550. The same type of hoist with a 20-hp. motor and correspondingly greater capacity costs about \$950. Such hoists are suitable for sinking prospect shafts where electric power is available and are frequently used for sinking winzes or shafts being deepened in relatively short lifts. An outfit consisting of a 2-drill portable gasoline compressor and a small air hoist is useful for sinking small prospect shafts remote from other workings. The hoist would not be required to operate while drilling was being done. A single-drum gasoline-driven hoist used by the United Verde Extension Mining Co. in sinking the Vulture No. 3 shaft to a depth of 450 feet at Wickenburg, Ariz., cost \$2,000. The air for the four machines used in drilling was supplied by a 350 cubic foot, 4-cycle Diesel compressor costing \$5,400.

HOISTS FOR SINKING DEEP SHAFTS

Occasionally a hoist for sinking a deep shaft in one lift must be purchased. Such a hoist, with a double drum capable of hoisting from a depth of 2,800 feet, purchased for sinking the No. 6 Magma shaft, cost about \$8,300, including a 100-hp. motor and three 37½-kv.-a. transformers. The cost of installing the hoist, including supplies, was \$2,900.

The Campbell shaft, described later, was sunk to the 2,800-foot level with a 4-foot double-drum hoist run by a 200-hp. motor. A 1-inch cable and a 16-cubic-foot bucket were used. This hoist was originally operated by compressed air but was converted into an electric drive for this job.

The Froid shaft of the International Nickel Co. was sunk 2,800 feet, using a regular mine hoist of 500 hp. with 10-foot double drums and a rope speed of 1,500 feet per minute. Three-ton skips were employed, and more than 200 tons were hoisted per 8-hour shift.

At the No. 5 shaft of the United Verde mine a 75-hp. hoist with a rope speed of 500 feet per minute was used with a 20-cubic-foot bucket. When a 38-cubic-foot skip was substituted for the 20-cubic-foot bucket this hoist did not supply enough power so was replaced by one having a 125-hp. motor.

The McPherson shaft of the Tennessee Copper Co. is sunk in either 250 or 450 foot lifts, using an 8-cubic-foot bucket and a $\frac{3}{4}$ -inch non-twist cable with a 25-hp. electric hoist. A crew of four men loads 393 cubic feet per shift.

The 3-compartment No. 4 shaft of the Christmas Copper Co. was recently completed to the 500-foot level. A compressed-air, 3-foot drum hoist capable of raising a 17-cubic-foot load 200 feet per minute was used for the first 100 feet and a similar hoist with a $4\frac{1}{2}$ -foot drum hoisting at the rate of 400 feet per minute for the rest of the way. A $\frac{3}{8}$ -inch hoisting rope was used for the first lift and a $\frac{7}{8}$ -inch cable for the second. These hoists were used because they were in stock.

CABLES

Wire ropes or cables are nearly always used with power hoists. Manila ropes may be used with hand windlasses or horse whims, but safety regulations and laws in most mining States require the use of wire ropes for shaft sinking where mechanical power hoists are employed.

Generally, relatively small sheaves are necessary in shaft-sinking operations. The average diameter of sheaves recommended by one manufacturer for a 6 by 19 rope is 45 times the diameter of the rope; for an 8 by 19 rope the sheave should be 31 times the diameter. The minimum diameter should be 30 times the rope diameter for 6 by 9 and 21 times for 8 by 19 cables. Because of the relatively small diameters of the sheaves the cables should be made of soft steel.

Ordinary-lay, or, better still, special nontwisting-lay cables should be used in shaft sinking. Lang-lay cable is not suitable for this work because of its tendency to twist under load. Sinking cables ranging from three-eighths inch to 1 inch in diameter were used at the shafts considered in this paper.

A factor of safety for hoisting cables for depths of 500 feet or less has been recommended by the Bureau of Mines.⁷ With depth the spring of the rope decreases the shock of starting and strain of acceleration; therefore a smaller factor of safety is allowable. The change in the safety factor more than compensates for the added weight of cable as depth is attained. The safety factor at 3,000 feet is given as 4.

The following tabulation gives data on nonrotating plow-steel hoisting rope of 18 strands with a hemp center and seven wires to the strand.

| Diameter of cable | Breaking strength, short tons | Safe load, factor of safety of 8, short tons | Weight per foot, pounds | Cost per foot (December, 1930—Arizona) |
|--------------------------|-------------------------------|--|-------------------------|--|
| 1 inch..... | 33.8 | 4.25 | 1.73 | \$0.28 |
| $\frac{7}{8}$ inch..... | 25.9 | 3.25 | 1.32 | .225 |
| $\frac{3}{4}$ inch..... | 19.0 | 2.50 | .97 | .18 |
| $\frac{5}{8}$ inch..... | 13.3 | 1.75 | .68 | .135 |
| $\frac{1}{2}$ inch..... | 10.8 | 1.50 | .55 | .120 |
| $\frac{3}{8}$ inch..... | 8.7 | 1.00 | .43 | .105 |
| $\frac{7}{16}$ inch..... | 6.7 | .80 | .33 | .090 |
| $\frac{3}{16}$ inch..... | 5.1 | .60 | .24 | .085 |

⁷ Ingalls, W. R., and others, Rules and Regulations for Metal Mines: Bull. 75, Bureau of Mines, 1915, p. 112.

The cost of standard plow-steel hoisting cable of six strands of 19 wires each is the same as shown in the above tabulation. The strength of the larger sizes of the standard cable is a little less than for the nonrotating cable.

HOOKS

Safety rules forbid the use of an open hook for attaching the cable to the bucket in shaft sinking. Various designs of closed hooks are in use.⁸ The device most favored in the West for attaching the

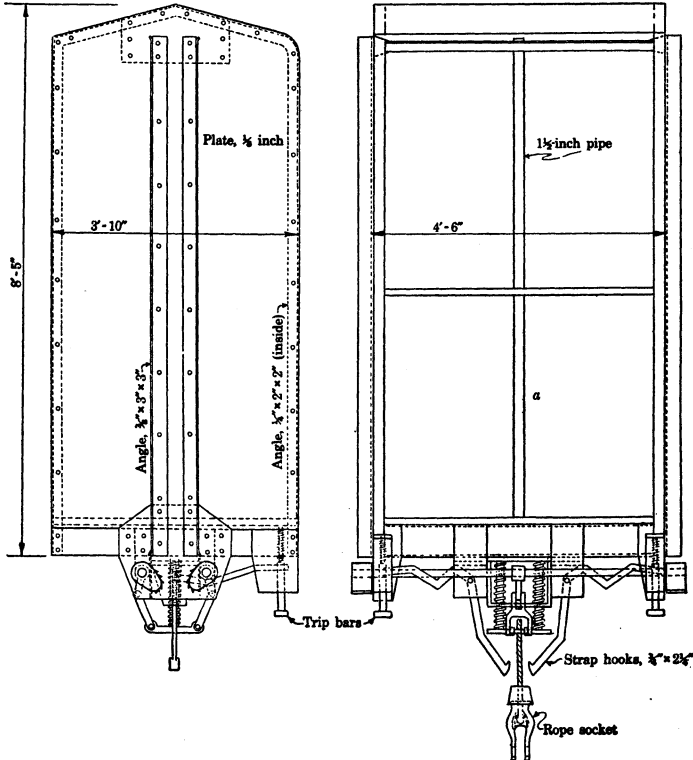

FIGURE 3.—Safety crosshead used in sinking Eureka shaft

bucket is a length of chain with an open link. The chain passes through a loop in the end of the cable and the bail of the sinking bucket. It is convenient for handling other equipment and timber in the shaft.

CROSSHEADS

State laws and safety regulations in most mining States require that crossheads and guides be provided for buckets or skips used in sinking vertical shafts. Crossheads may be constructed of wood or of steel. Their height should be greater than the distance between the guides to insure smooth traveling and freedom from binding against the guides. The crosshead should be secured to the hoist

⁸ Kudlich, R. H., *Safe Mechanical Equipment for Use in Shaft Sinking*: Tech. Paper 276, Bureau of Mines, 1922, Pl. I.

rope so that it can not hang up on an obstruction in the shaft without stopping the bucket. Otherwise it might jar loose after the bucket had descended some distance and cause a wreck.

Figure 3 shows a safety crosshead in combination with a cage used at the Eureka shaft at Ramsay, Mich.⁹ The crosshead is equipped with safety dogs that grip the wooden guides if the rope breaks. In such event the collar of the rope socket would be held up by the hooks shown in the open position. The rope passes through the pipe directly to the rope socket, to which the bucket is attached. The weight of the cage rests upon the top of the rope socket. Near the bottom of the shaft one of the shaft sets is provided with stop blocks upon which trip bars come to rest, releasing the hooks and permitting the bucket to continue to the bottom to be loaded.

At the Magma No. 6 shaft and in some other mines an ordinary mine cage with safety dogs is used in connection with sinking; a separate crosshead is therefore not needed for the bucket. The bucket is attached by means of a length of cable to the bottom of the cage. The timbering, of course, must be kept low enough so that the bucket will reach the bottom before the cage comes off the guides.

In timbered shafts permanent guides are usually installed as the shaft is timbered. If the shaft is concreted as it is sunk temporary guides are installed for the sinking bucket or skip. In large-section shafts one large compartment may be used for hoisting the broken rock. At the Campbell shaft temporary guides were installed at either end of the large compartment for two bucket ways.

In large circular shafts special dividers or buntons may be placed to hold the guides. Wire guides were used in sinking the Randfontein circular shaft; these are sometimes used in sinking coal-mine shafts. A ton or so of cast iron attached to the lower end of the wires and resting on the bottom of the shaft holds the guides taut.

In sinking inclined shafts a set of extension rails is usually laid so that the skip can be run to the bottom where it is loaded. In small inclined shafts buckets traveling on slides may be used. The slides consist of two parallel timbers running lengthwise of the shaft. The timbers are fastened to cross stulls; the distance between them is slightly less than the diameter of the bucket, and the upper inside corners are beveled.

HEADFRAMES

Generally a special headframe is erected for sinking shafts from the surface. The Cananea Consolidated Copper Co., Sonora, Mexico, has developed a standard headframe for this purpose. It is a 2-post or A type constructed of 10 by 10 and smaller standard sizes of mine timber tied together with 1-inch tie-rods. It carries two sheave wheels at a height of 35 feet above the collar of the shaft, giving a working clearance of about 32 feet. The A frame is sup-

⁹ Engineering and Mining Journal, Safety Crosshead Reduces Accidents and Attendant Expenses: Vol. 128, Nov. 16, 1929, p. 780.

ported on four concrete piers, and the guide supports rest on the shaft collar. This headframe can be erected in a few days by the construction crew available at any large mine. For large hoisting engines a larger headframe would be needed.

A saving in the cost of erecting a headframe, particularly where transportation is a problem, can sometimes be made by constructing the members of 2-inch planks nailed together to give the desired size. An A-type headframe of such laminated construction was used in sinking the Water Lily shaft at Eureka, Utah. The posts, backstays, and bracing members were built by nailing and bolting together eight plies of 2 by 12 inch plank. Two sheaves were supported on a framework of solid timber to give a working clearance of about 35 feet above the shaft collar.

EXCAVATING SHAFTS

The first shaft at a mine must, of course, be sunk; subsequent shafts may be sunk or raised, depending on local conditions or individual preferences. In large shafts part of the shaft may be sunk and the rest raised. At the Old Dominion mine, Globe, Ariz., three compartments of a shaft were sunk and the other two raised.

Owing to the difficulty of making exact connections, lower sections of shafts are seldom raised full size. The permanent linings usually are constructed after the connections are made. Long raises may be put up full size from the bottom for working shafts in undeveloped territory. Permanent linings of such shafts can be placed as raising progresses.

In general, sinking is preferred where long lifts are necessary, especially where rock is of high temperature or where a shaft raise would be remote from the main ventilation system of the mine. Enlarging raises to full shaft section in slabby ground may result in serious overbreak, making necessary one or more stringers behind the shaft timber.

In shaft sinking the largest labor cost is for removal of the broken material. If shafts are raised the expense of shoveling is eliminated and hoisting in the completed section above is not hampered. The inconvenience and cost of handling the water in a raise are less than in a shaft. Much greater progress can be made by raising a shaft than by sinking it if a number of crews are working at different levels. Should long crosscuts that would not otherwise be required be run to reach the shaft this method is more costly than direct sinking.

If only one crew is working greater speed can be obtained by straight sinking with full section. The total cost per foot appears to be higher for raising, unless in lifts of about 300 feet or less.

Table 2 shows the system of excavating, rate of progress, and costs of various sections of the Campbell shaft of the Calumet and Arizona Mining Co. As shown in the table, the cost per foot was less with straight sinking than with the other methods followed except for a 100-foot lift.

TABLE 2.—*Cost of excavating Campbell shaft, Calumet and Arizona Mining Co.*

| Section | Dis- tance, feet | Method | Cost | | | | Advance, feet per day |
|-----------|------------------------|---|------------------|---------------|----------------|---------|-----------------------------|
| | | | Sinking crews | Hoist- ing | Top landing | Total | |
| 0-40 | 40 | Sunk..... | \$29.80 | \$15.02 | ----- | \$44.82 | 1.00 |
| 40-575 | 535 | 2 compartments sunk, 1 raised..... | 63.53 | 12.09 | \$1.14 | 76.76 | 2.04 |
| 575-695 | 120 | Large raise and trimmed to section..... | 53.97 | 15.36 | ----- | 69.33 | 2.94 |
| 695-1245 | 750 |do..... | 52.24 | 17.19 | .36 | 70.29 | 2.78 |
| 1245-1363 | 118 | Small raise and ringed to section..... | 33.33 | 4.68 | .86 | 38.87 | 1.82 |
| 1363-1665 | 302 | Sunk..... | 48.57 | 8.83 | 4.13 | 61.53 | 4.35 |

Table 3 gives comparative cost figures in two sections of the Morning shaft at Mullan, Idaho. In one section two compartments were sunk and then the other two raised. In the second section all four compartments were sunk as one operation. Both the time of sinking and cost per foot were less in the second section.

EXCAVATING SHAFTS

TABLE 3.—Cost of excavating Morning shaft from 2,050 to 2,450 foot level

| Operation | Period | | Footage | | Labor | | Supplies | | Total | | | Contractor's average earnings per shift |
|--|--------|------------|------------|----------|----------------|------------|----------|----------------|------------|----------|----------------|---|
| | Feet | Cubic feet | Amount | Per foot | Per cubic foot | Amount | Per foot | Per cubic foot | Amount | Per foot | Per cubic foot | |
| Shaft, from 2,050 to 2,250: | | | | | | | | | | | | |
| Repairs before sinking 1 | 221 | 25,850 | \$2,036.00 | \$9.19 | | | | | | | | |
| Sinking 2 compartments | 221 | 23,850 | 11,511.85 | 48.30 | \$0.443 | \$1,710.04 | \$26.64 | \$0.229 | \$4,648.94 | \$21.03 | \$0.072 | |
| Raising 2 compartments | 221 | | 6,850.89 | 29.13 | .288 | 2,549.05 | 12.89 | .119 | 17,298.45 | 78.27 | | |
| Repairs during sinking and raising | | | 2,477.95 | 11.22 | | 1,006.72 | 4.55 | | 6,728.40 | 44.02 | .407 | \$7.82 |
| Guides and repairs | | | 624.75 | | | 366.86 | | | 3,434.67 | 13.77 | | |
| Total | 221 | 49,700 | 24,331.80 | 110.10 | 4.490 | 11,819.27 | 53.48 | 4.238 | 36,151.07 | 163.58 | 4.728 | |
| Direct cost, sinking and raising only (including repairs during sinking and raising) | | | | 93.98 | | | 44.08 | | | 138.06 | .614 | |
| Sinking 4 compartments, 2,250 to 2,450 | 200.5 | 45,060 | 11,683.70 | 58.27 | .259 | 9,114.86 | 45.46 | .202 | 20,798.56 | 103.73 | .461 | 8.53 |
| Hoisting | 40 | | 1,553.35 | 7.80 | .034 | 577.50 | 2.88 | .013 | 2,140.85 | 10.68 | .047 | |
| Mechanical | 40 | | 562.35 | 2.80 | .012 | | | | 562.35 | 2.80 | .012 | |
| Total | 200.5 | 45,060 | 13,800.40 | 68.87 | .305 | 9,692.36 | 48.34 | .215 | 23,501.76 | 117.21 | .520 | |

¹ All labor items in section include hoist man's time on sinking hoist—retimbered 18 sets.

² Contracted at \$37 per linear foot but paid at day's pay as contractor's earnings were below current wage scale.

³ Contracted at \$27 per linear foot.

⁴ Average.

At the Bunker Hill & Sullivan mine, Kellogg, Idaho, the cost of raising inclined shafts is considerably less than the cost of sinking them. The following tabulation shows comparative figures in sinking No. 1 shaft and raising No. 2 shaft between the eighteenth and nineteenth levels:

| Shaft | Method | Inclination | Cubic feet per foot advance | Cost per foot advance | Cost per cubic foot |
|------------|--------------|-------------|-----------------------------|-----------------------|---------------------|
| No. 1..... | Sinking..... | 50° | 160 | \$58.41 | \$0.36 |
| No. 2..... | Raising..... | 40° 30' | 128 | 17.92 | .14 |

RAISING SHAFTS

The usual method of raising shafts is to run a pilot raise through to make a connection and then to enlarge the section to full size by blasting ring rounds or by shrinkage stoping. The permanent timbering is done from the top down as the broken rock is drawn. Concreting may be done in sections as the broken rock is withdrawn. If connections with the part of a shaft already completed are unnecessary, as was the case when the main Star raise of the Hecla Mining Co., Burke, Idaho, was driven, the shaft is raised the full section. Foreman states:¹⁰

The Star main raise is being driven upward by the shrinkage method, the permanent sets being placed from the top of a completed section as the broken waste is removed.

As the raise is driven one compartment is timbered by placing two caps across the raise 5 feet apart, center to center both horizontally and vertically. This compartment is divided into a manway and a timber slide and is placed directly over one of the center compartments in the completed portion of the raise. The outside of the compartment is lined with a double thickness of 3-inch by 5-foot lagging of random widths, which forms a chute on each end of the raise. A chute gate is maintained at the bottom of a temporary section, and any large bowlders are blasted here before going through a grizzly into the chute in the completed raise.

The raise as driven measures 24 by 9 feet, allowing 1 foot of room around the raise for the blocking of permanent timbers.

A section of the raise is driven to a point about 90 feet above a proposed level. The removal of the temporary timbers and the broken waste is then started, and regular framed shaft timbers are placed, beginning near the top of the raise and leaving room for starting the next lift upward. The permanent timber is added a set at a time, the timbermen working on top of the broken waste, until a connection is made with the timbering of the completed raise below.

As the raise is being driven upward it is checked by the company engineers, so that the axis of the raise will be parallel and directly above the axis of the completed raise below. Considerable care is also necessary in placing the first permanent set of timbers at the top of a lift. This method of timbering was considered necessary because of the length of wall plate used, which is 22 feet, and the desire to have the completed raise timbered with unbroken wall plates for the length of the raise.

Lifts of 200, 400, and 600 feet have been driven in this manner. It is the experience in the Star mine that a lift should not be greater than 400 feet.

The contract price for the Star raise includes driving the raise, with temporary timbers, and also the placing of the permanent timbers. Five per cent of the money earned by the contractors is withheld until the permanent

¹⁰ Foreman, Charles H., *Mining Methods and Costs at the Hecla and Star Mines, Burke, Idaho*: Inf. Circ. 6232, Bureau of Mines, 1930, 21 pp.

timbers are placed, and any expense caused by improper driving of the raise is deducted from the amount due the contractors.

At the United Verde Copper Co. the No. 5 shaft is sunk and other shafts raised. The No. 6 shaft is raised in full section from level to level, using a double-cribbed manway. The walls are checked by the company engineers every second round, and in contract work the contractors were penalized 10 cents per cubic foot for all overbreakage. The shaft above the 1,950-foot level was lined with solid concrete walls, using square-sets and wooden forms. The broken rock was drawn down 20 to 50 feet at a time, depending on the ground. The sets and forms were then placed, and the section was concreted. The part of the shaft below the 1,950-foot level was in good ground requiring little support, and the concrete was placed in 2½-foot rings on 6-foot centers.

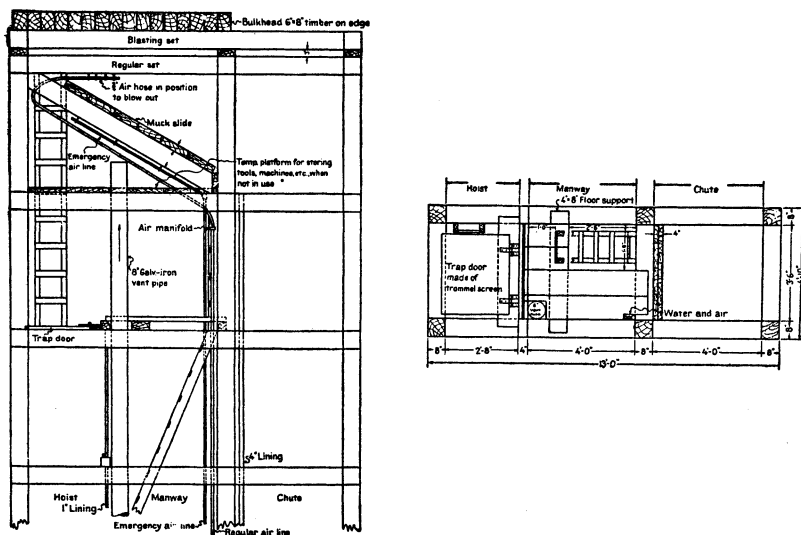

FIGURE 4.—Pilot raise, No. 6 shaft, Morenci, Ariz.

Data on raising the lower part of the shaft follows:

| | | |
|--------------------------------------|-----------|------------|
| Rock section of shaft..... | feet..... | 14½ by 14½ |
| Average depth of holes..... | do..... | 5 |
| Average number of holes..... | | 44 |
| Total footage drilled per round..... | | 220 |
| Average advance per round..... | feet..... | 4 |
| Average advance per shift..... | do..... | 1½ |

The costs of raising were as follows:

| | |
|-------------------|---------------|
| Labor..... | \$52. 07 |
| Shops..... | . 26 |
| Supplies..... | 7. 68 |
| Explosives..... | 8. 47 |
| Air..... | 2. 08 |
| Repairs..... | 6. 55 |
| Total..... | 77. 11 |

At the Morenci Branch of the Phelps Dodge Corporation, Morenci, Ariz.:¹¹

Pilot raises are used for making shaft connections. After the connections are made the raises are enlarged to full shaft size, beginning at the point of connection and carrying the timbering downward.

For distances of over 200 feet raises are run with three compartments. The size of the compartments and the timbering details are shown in the figure (fig. 4). One compartment is used for holding the broken rock, the middle one is a manway, and the third compartment is used for a light cage to handle men and supplies used in the raise. Stations are cut every 100 feet. As soon as a raise has progressed 30 feet above a substation the sheave for the hoist is raised and hoisting is done to that level.

To reduce the excessive weight of broken rock at the bottom of the chute of such a long raise, rock is transferred through auxiliary chutes spaced 100 feet apart.

All raise rounds are blasted electrically, using five delays. Before loading the holes the miner doing the work obtains the only key to the lock of the

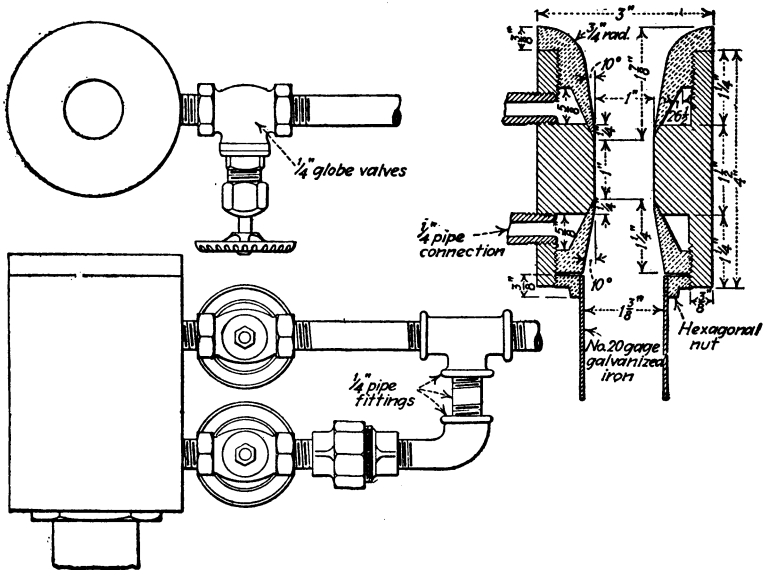

FIGURE 5.—Compressed-air injector used by Moctezuma Copper Co. for ventilating raises through diamond-drill holes

blasting switch. After the round is loaded the man in charge connects the lead wires to the blasting line 25 feet from the bulkhead, where a second man is stationed. These men then descend to an interrupter switch at the bottom of the raise. After the approaches to the raise are guarded the interrupter switch is closed and the round blasted through the main blasting switch.

The back of the raise is never more than 12 feet above the timber. After a round is blasted a 5-foot set is put in place; on top of this a blasting set is installed, and then the next round is drilled. The broken rock in the raise is kept within 6 feet of the bulkhead. Just before blasting, enough rock is drawn from the chute to provide space for the material broken by the blast.

Since the foregoing was written (March, 1929) the company has adopted the practice of drilling a hole with the diamond drill on the true center line of the shaft, through which the heading is venti-

¹¹ Mosier, McHenry, and Sherman, Gerald, Mining Practice at Morenci Branch, Phelps Dodge Corporation, Morenci, Ariz.: Inf. Circ. 6107, Bureau of Mines, 1929, 33 pp.

lated by means of a compressed-air injector. Figure 5 shows the compressed-air injector used for the same purpose at the Pilares mine of the Moctezuma Copper Co.¹²

The Pilares shaft of the Moctezuma Copper Co. at Pilares, Sonora, Mexico, was deepened from the 1,400 to the 1,800 foot level during 1924 and 1925 by the following method:¹³

After drifting to the shaft location on the 1,800, 1,700, and 1,600 levels from the Guadalupe shaft a pilot raise 4 feet by 7 feet in section was driven as closely as possible in the center of the shaft location, from the 1,800 and 1,600 levels. The 1,800 raise connected with the 1,700 level and continued on to the 1,600 level. The raise from the 1,600 level connected with the sump below the 1,400, a total height of 187 feet.

When the pilot raises were completed a shrinkage stope was started 20 feet above the 1,600 level, as near 12 by 20 feet in section as possible, to accommodate the shaft timbers, which required an over-all space of 11 by 19 feet. As the rock broke in large fragments, a "Chinaman chute" shovel way was built on the 1,600 level, so arranged that the raise from below was left open and protected.

All the overbreak was drawn off through the shovel way as the shrinkage operation progressed. The same procedure was carried on with the section between the 1,800 and 1,600 levels.

After breaking through with the shrinkage operation into the bottom of the shaft and prior to starting the timbering, solid bulkheads were placed just below the 1,400 level in all compartments, except in the manway and the center-cage compartment, in order to protect the workmen from possible falling material in the operation section of the shaft, between the surface and the 1,400 level. A bulkhead was placed in the manway compartment just above the level, which allowed free access into this compartment. In the center-cage compartment a bulkhead was placed 50 feet above the 1,400 level, and cage service in this compartment was stopped at the 1,300 level. Cage service in the other two compartments continued to the 1,400 level throughout the deepening process.

A small service hoist was installed on the 1,400 level, and service was maintained in the center compartment, through which all timber and supplies for the job were handled.

The shaft was timbered with redwood throughout. The wall plates, end plates, and posts are 12 by 12 inches; dividers are 10 by 12 inches and 8 by 12 inches. The lagging is 2-inch redwood plank.

As each set was hung, the broken rock was drawn down sufficiently for the placing of an additional set. In some places the walls had sloughed to an extent which made bridging behind the sets necessary. However, little trouble was experienced with overbreak during the shrinkage operation and, due to careful engineering supervision, no extra rock had to be cut to make room for the timbers.

The operations incident to the deepening of this shaft are divided into: (1) Driving of the pilot raises, (2) the shrinkage of the shaft to full size required for timbering, and (3) the placing of the timber.

Following are the cost and efficiency data figures:

Sinking new Pilares shaft from 1,400 to 1,800 levels

| Summary : | Amount | Cost per foot |
|-----------------------------|--------------|---------------|
| Pilot raises..... | \$2, 681. 47 | \$7. 066 |
| Widening and shrinkage..... | 2, 846. 46 | 7. 501 |
| Timber and timbering..... | 15, 998. 29 | 42. 156 |
| Miscellaneous..... | 4, 200. 48 | 11. 068 |
| | 25, 726. 70 | 67. 791 |

¹² Efficient Air Injector for Raise Ventilation: Eng. and Min. Jour., vol. 131, Apr. 27, 1931, p. 368.

¹³ Leland, Everard, Mining Methods and Costs at the Pilares Mine, Pilares de Nacozari, Sonora, Mexico: Inf. Circ. 6307, Bureau of Mines, 1930, 34 pp.

| Statistics: | Miscellaneous |
|--|---------------|
| Distance sunk.....feet..... | 379. 5 |
| Distance timbered.....do..... | 382. 5 |
| Size of shaft excavation.....do..... | 12 by 20 |
| Over-all dimensions of timber.....do..... | 11 by 19 |
| Total labor cost..... | \$9, 111. 65 |
| Total shifts..... | 2, 568½ |
| Shifts per foot of advance (sinking only)..... | 6. 76 |
| Total labor cost, excluding shop expense and timber framing..... | \$7, 272. 99 |
| Total shifts, excluding shop and timber framing..... | 1, 954½ |
| Shifts per foot of advance (timbering and framing)..... | 5. 15 |
| Timber used.....board feet..... | 248, 909 |
| Timber per foot of shaft timbered.....do..... | 650 |
| Total powder used.....pounds..... | 3, 778 |
| Powder per foot of shaft.....do..... | 9. 95 |
| Pilot raises started March 8, 1924. | |
| Shaft in operation December 15, 1925. | |

Details and distribution of costs

Pilot raise:

| Labor— | Amount | Cost per foot |
|-------------------------------|------------|---------------|
| Breaking..... | \$844. 85 | \$2. 449 |
| Mucking..... | 231. 15 | . 670 |
| Supplies..... | 29. 00 | . 084 |
| Drills and tools..... | 802. 40 | 2. 325 |
| Explosives, 1,716 pounds..... | 660. 54 | 1. 915 |
| Timber, 2,640 board feet..... | 113. 53 | . 329 |
| Total..... | 2, 681. 47 | 7. 772 |

| | Miscellaneous |
|---|---------------|
| Feet of raising..... | 345 |
| Feet per shift, contractor breaking only..... | 2. 09 |
| Pounds powder per foot..... | 4. 973 |
| Contract breaking shifts..... | 165 |
| Contract mucking shifts..... | 186 |
| Total shifts..... | 351 |
| Feet per shift..... | . 983 |

Widening and shrinkage:

| Labor— | Amount | Cost per cubic meter (35.3 cu. ft.) |
|--|-------------|-------------------------------------|
| Shaft (277½ shifts)..... | \$1, 831.07 | \$0. 774 |
| Shop (10 shifts)..... | 30. 35 | . 013 |
| Drills and tools..... | 553. 03 | . 234 |
| Explosives and handling..... | 432. 01 | . 183 |
| Total..... | 2, 846. 46 | 1. 204 |
| Tramming cost, 15 cents gold per ton-car, not included in this cost. | | |
| Powder used per cubic meter.....pounds..... | 1. 631 | |
| Volume removed.....cubic meters..... | 2, 364 | |
| Distance shrunk.....feet..... | 379. 5 | |

Timbering:

| Labor— | Amount | Cost per foot |
|--|--------------|---------------|
| Framing (466¼ shifts)..... | \$1, 428. 30 | \$3. 734 |
| Placing (861 shifts)..... | 3, 160. 94 | 8. 264 |
| Shop (38 shifts)..... | 249. 10 | . 651 |
| Total..... | 4, 838. 34 | 12. 649 |
| Timber and supplies, 212,346 board feet..... | 11, 119. 95 | 29. 072 |
| Incline charges..... | 40. 00 | . 105 |
| Total timbering cost..... | 15, 998. 29 | 41. 826 |
| Labor represents 382.5 feet of completed work. | | |

Miscellaneous expenses incident to completing shaft¹⁴

| Labor : | Amount | Total |
|--|--------------|--------------|
| Sundry contracts (485 shifts)----- | \$1, 204. 98 | |
| Shops (59% shifts)----- | 130. 91 | |
| | ----- | \$1, 335. 89 |
| Supplies----- | | 1, 029. 22 |
| Drills and tools----- | | 111. 49 |
| Explosives and handling, 431 pounds----- | | 114. 23 |
| Timber, 33,923 board feet----- | | 1, 609. 65 |
| | | ----- |
| | | 4, 200. 48 |

(All costs are calculated in United States gold.)

The following tabulation gives general and cost data of raising the No. 2 shaft between the nineteenth and eighteenth levels at the Bunker Hill & Sullivan mine, Kellogg, Idaho.

Shaft-raising data

Company: Bunker Hill & Sullivan Mining & Concentrating Co.

Mine: Bunker Hill.

Shaft: No. 2, inclined; total length on incline, 3,075 feet.

Type of deposit: Large, irregular bodies of argentiferous galena and siderite gangue.

Formation: Quartzite.

Character of formation: Sedimentary.

Inclination of shaft: 49° 35'.

Section of shaft: 8 by 16 feet before timbering.

Compartment:

Number: 3.

Size hoisting: Two 4 feet 7 inches wide by 5 feet 0 inches high.

Size manway: One 3 feet 2 inches wide by 5 feet 0 inches high.

Distance raised: From No. 19 to No. 18, 295 feet.

Number of shifts per 24 hours: 1.

Raising crew:

Top: 9.05 men per 8 hours.

Bottom: 0.25 man per 8 hours.

Kind of drills: 108-pound wet stopers.

Kind of rounds: V cut.

Number of holes per round: 24.

Depth of rounds: 5 feet 6 inches.

Explosive: 35 per cent gelatin.

Timbering:

Distance between centers of sets: 5 feet.

Size of timbers: 10 inch by 12 inch by 15 foot caps and sills; 10 inch by 10 inch by 5½ inch posts; 6 inch by 10 inch by 5½ inch dividers.

Kind of timber: Fir.

Kind of framing: V-shaped mortises and tenons.

Wages, per shift: Bosses, \$7.50; timbermen, \$5.50; raise men, \$5.00; helpers, \$4.50.

Drill steel:

Size, inches: 1.

Section: Square.

Starter gage, inches: 2.

Gage reduction: ¼ inch.

Steel changes, inches: 18.

General data:

Date shaft raised: From May 30, 1927, to July 28, 1927.

Character of ground: Medium hard.

Water: Approximately 10 gallons per minute.

Inclination of shaft: 40° 35'.

Tons broken per foot advance: About 8½.

¹⁴Including building bulkheads, safety devices, installing equipment, and incidental supplies and labor.

General data—Continued.

Footage from No. 19 to No. 18: 295.
 Advance per day: 5 feet.
 Advance per round: 5 feet.
 Total shifts: 550½.

Raising costs:

| Labor— | Dollars per foot | Units of labor or supplies per foot (man shifts) |
|---------------------------------------|---------------------|--|
| Raising crews— | | |
| Bosses----- | \$0. 47 | 0. 0625 |
| Timbermen----- | 3. 30 | . 6077 |
| Raise men----- | 5. 41 | 1. 0769 |
| Helpers----- | . 41 | . 1111 |
| Total----- | 9. 59 | 1. 8582 |
| Other labor— | | |
| Framing timber----- | . 64 | . 21 |
| Sharpening steel----- | . 35 | . 10 |
| Total----- | . 99 | . 31 |
| Total labor----- | 10. 58 | 2. 17 |
| Supplies— | | |
| Timber----- | 3. 68 | 153. 3 board feet |
| Explosives----- | 2. 05 | 12. 2 pounds |
| Miscellaneous----- | . 17 | |
| Total----- | 5. 90 | |
| Power— | | |
| Drilling----- | 1. 11 | |
| Hoisting----- | . 33 | |
| Total----- | 1. 44 | |
| Total labor, supplies, and power----- | 17. 92 | |

The junior author recently completed a shaft raise 5 feet 8 inches by 15 feet 10 inches in section for the Utah Copper Co., Bingham, Utah. Figure 6 shows the method of timbering. This raise was 300 feet high with stations every 100 feet. The ground was medium hard to hard quartzite and limestone. The contract price for all labor and insurance was \$0.17 per cubic foot. A 6-inch maximum overbreak was allowed. Assuming a 3-inch average overbreak on all sides, the labor cost per foot of advance was \$17.23.

Because of the heavy sulphide ore to be handled through the chutes this raise was cribbed for 60 feet above the main haulage level. Except on stations ordinary stope timber was used for the remainder of the raise. The sets were 7 feet apart vertically, and rounds were broken 7 feet deep. With five men per shift working on two shifts per day an average advance of one 7-foot set was made every three shifts. One and one-half shifts were used for drilling, one for timber and raising bulkheads, and one-half shift for blasting and miscellaneous repairs. Blasting was done with caps and fuse, because of the necessity of carrying the completed timbering close to the back.

SINKING SHAFTS

Organization plays an important part in the cost and speed of sinking shafts. Proper planning of the work will obviate unwarranted delays which retard work and increase costs. The principle to be followed is that all other workmen connected with the opera-

tions should serve the men at the bottom and keep them supplied with tools and equipment. Mechanics putting in pipes or wiring should plan their work so as not to interfere with the men at the bottom. The only delay permissible should be that required for clearing out the gases after blasting; this time can be kept to a minimum by efficient ventilation. Good equipment kept in repair should be provided. Inadequately serviced drills or poor hose may increase the cost of sinking to a marked extent. The broken rock should be hoisted as fast as the shovelers can fill the buckets. An adequate pump should be supplied so that in wet shafts delays due to water may be kept to a minimum. All work possible should be done on top.

CREWS

In ordinary sinking operations shaft crews are divided into two sections—sinkers and topmen. Bonuses for speed are usually paid only to the men who do the actual excavating. On the Rand¹⁵ the bottom crew in a 23½-foot-diameter circular shaft consisted of 40 men. In a 10 by 42 foot shaft in the same district 82 natives were used at the bottom. In western metal mines a maximum crew of two men for each 4½ by 5 foot compartment works at the bottom. Generally the bottom crew for a 3-compartment shaft would be four men (see Table 1). In sinking the Froid No. 3 shaft, 17 by 29 feet in section, 16 drillers worked at one time.¹⁶

Each man at the bottom usually operates an air drill in drilling rounds; however, in sinking the Saginaw shaft of the Calumet and Arizona Mining Co. a crew of six men ran drills, and two other men "tended chuck" for them.

In wet shafts a pump man may be employed in addition to the sinking crew, and in large shafts other workmen may be regularly employed in the shaft during sinking.

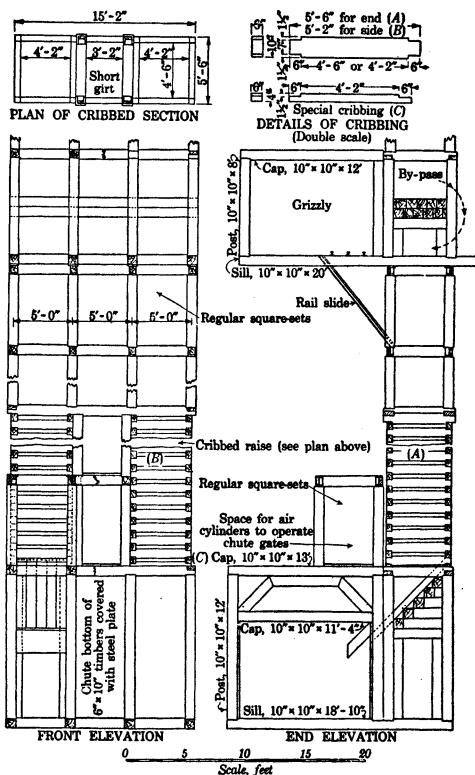

FIGURE 6.—Method of timbering shaft, Utah Copper Co.

¹⁵ Nixon, W. G. C., Sinking of the Randfontein Ventilation Shaft: Eng. and Min. Jour., vol. 124, Oct. 29, 1927, p. 692.

¹⁶ Brock, A. F., Sinking No. 3 Shaft at Froid: Eng. and Min. Jour., vol. 130, Nov. 10, 1930, p. 443.

At some mines special crews do the timbering, either working regularly or called out when a set is to be placed. These men place the timber while other work is being done at the bottom.

A special timbering crew in an ordinary 3-compartment shaft consists of three to six men, depending on the number of sets placed per shift. In the Frood shaft a special crew of 10 men with a leader did the timbering and was called out only when a set was to be hung.

The topmen consist of a hoist engineer and a top lander. In addition, a trammer may be necessary to take away the broken rock. At a small shaft the hoist engineer may also act as a top lander.

As most shafts are sunk in conjunction with other mining operations compressed air is furnished from the main plants, and the steel is sharpened in the mine shops. When shaft sinking is the only mining operation being conducted a drill-sharpening and repair shop must be maintained. The hoist engineer usually looks after the compressor when a separate plant is needed.

Workmen are also needed to frame the shaft timbers. One man usually can frame one set per day for ordinary-size shafts.

ROUTINE

Operations in sinking shafts are generally continuous over 24 hours a day. For rapid sinking apparently the best results can be obtained by completing a cycle each of three shifts per 24 hours. In the Randfontein shaft only as much ground was broken as could be removed on the following shift and still have time for drilling the next round. Shoveling was started at the beginning of the shift and was completed in about $6\frac{1}{4}$ hours. Drilling was begun about mid-shift— $1\frac{1}{2}$ hours before shoveling was finished—and was completed in time to blast the round by the end of the shift. A round consisted of about sixty 4-foot holes. Under a similar routine the world record of 427.5 feet in a 31-day month, described later, was made at the Water Lily shaft. Here timbering was done from a suspended bulkhead while the rounds were being loaded out. In some mines one shift drills the round, the second removes the spoil, and the third places the timber. The same men perform the same duties day after day, thus becoming specialists. This practice is an advantage; but when a breakdown or other delay occurs the routine is upset, and a round may be lost. Where the shovelers, topmen, and timbermen can be employed elsewhere the failure to complete a round does not materially increase the cost per foot. The practice most commonly followed is for each shift to do the work at hand. This method requires men of wider training and experience but is advantageous in that the work is continuous. As soon as a round is finished it is blasted, and after the shaft is cleared of smoke shoveling is started. By this procedure a 5 or 6 foot round can be blasted and the cycle completed in a 3 or 4 compartment shaft each day without impairing the efficiency of the crew by crowding in extra workmen. Apparently lower sinking costs in most cases can be obtained by following this system than by performing the prescribed work at a fixed time. When deeper rounds are broken a cycle can not, as a rule, be completed each 24 hours.

Table 1 shows the routine followed in a number of representative shafts. An exception to the general rule is shown at the Ajax shaft,

where sinking is done only during two shifts per day, which procedure dovetails with the other work in the mine. This effects a saving in wages for compressor men and in supervision. When blasting is done at the end of one of the two shifts the men do not have to wait for the smoke to clear out.

The routine of operations for most shaft-sinking jobs is: Drilling, hoisting tools and steel, blasting, waiting for smoke to clear out, cleaning off timbers of all loose rocks or materials, barring down and trimming section, shoveling, timbering, lowering tools, and connecting hose for drilling.

DRILLING

DRILLS

At present, hand-held drills are used almost exclusively for drilling rounds in vertical shafts. Mounted Leyners are occasionally used in inclined shafts. Various types of sinking drills are employed, the lighter jack-hammer-type machines in easily drilled ground and the heavier drills in harder rock. The heavy machines are more generally used. (See Table 1.) In the past mounted drills were used for drilling hard ground, but the present type of heavy hand-held drills has proved satisfactory for this purpose. In some mines the drills are hoisted and inspected and any repairs made after each round. In others they are left connected to a manifold and removed from the shaft only when a failure occurs. Spare drills are kept handy in case of a breakdown during the drilling shift.

STEEL

As shown in Table 1, $\frac{7}{8}$ to $1\frac{1}{4}$ inch hollow drill steel is used in hexagonal, round, and quarter-octagon sections. One-inch hexagonal steel appears to be generally preferred. The reduction in gage between succeeding bits is one-sixteenth to one-fourth inch, depending mainly on the hardness of the rock and the custom in the district or at the mine. A difference of 10 to 18 inches between steels is used at various places.

One-inch-diameter steel, a difference of one-eighth inch in the gage of bits, and a difference of 12 inches between changes seem satisfactory for drilling in ground of medium hardness. When there is a greater difference in gage or where the gage is not lost in drilling a longer change could be used. In very hard ground breakage may be excessive with 1-inch-diameter steel; then $1\frac{1}{8}$ or $1\frac{1}{4}$ inch steel should be used. Seven-eighths-inch steel is satisfactory in easy-drilling ground, but with the heavy drills required for hard ground the breakage is likely to be excessive. Usually the same steel and the same type of drills are used in shaft sinking as in regular mine operations; the expense of handling a separate class of steel for the shaft work would probably be greater than the saving made by the use of a special lot. At the end of the drilling shift all steel is hoisted in the sinking bucket or skip.

The ordinary cross bit is generally used. In gravelly ground a Carr or chisel bit is more satisfactory. In sinking the Vulture shaft cross bits were used on the starters and the Carr bit on the rest of the steel.

COLLARING HOLES

The present practice, particularly in loose or broken ground, is to start the holes of a shaft round 2½ inches in diameter and drill them 5 to 12 inches deep with the starter. A piece of 2-inch pipe is then placed in the collar of the hole, and the rest of the hole is drilled through the pipe. The pipe prevents mud and small particles of rock from falling into the hole and causing the drill bit to stick. The pipe also keeps the holes clean until time to load. Most of the pipe is recovered during the shoveling operations and is used again.

Where the ground is firm the pipes may not be used, and wooden plugs driven in the collars of the holes keep loose material from falling into them until loading is begun.

MANIFOLDS

One of the devices for permitting rapid resumption of drilling is a combination air-and-water manifold or header to which hose for the drills are attached; this can be lowered and connected up with the minimum delay. It usually consists of two short lengths of 8-inch pipe connected at the ends with blind flanges. At some mines the two sections are placed side by side. The air

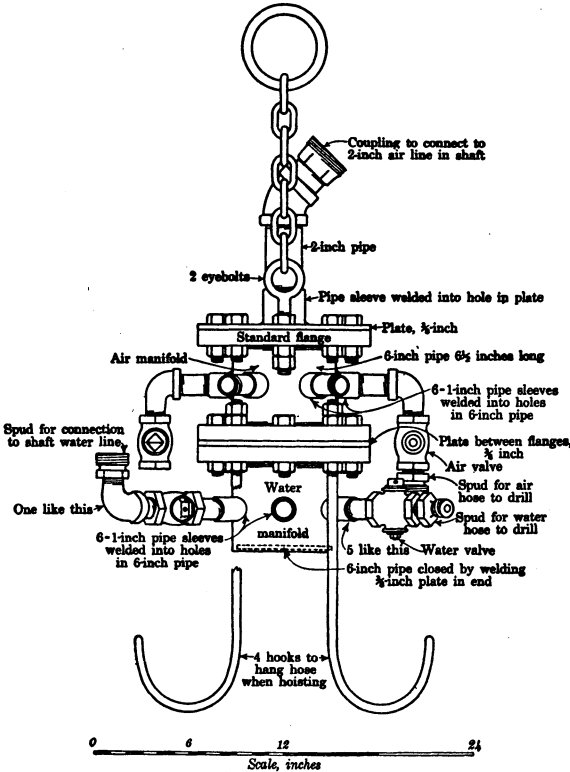

FIGURE 7.—Manifold for drills used at Magma mine

section is tapped for a connection with the main air line and for connections with the hose of each drilling machine and of two blowpipes. In the water section are connections for the main water line and for the water hose of each drill. The pipe connections may be threaded or welded to the manifold; each should have an elbow or bend to permit the hose to hang straight downward. Figure 7 shows the manifold used at the Magma Copper Co.

A more elaborate manifold was used for shaft sinking at the Ojuela mine of the Cia. Minera de Penoles, S. A., Monterey, Mexico. This manifold is designed to distribute compressed air from a 2-inch intake pipe to seven ¾-inch air cocks. No provision is made for water connections. Air under pressure is admitted to a lubricating-

oil chamber to permit the oil to run by gravity through adjustable feeders into the several air lines. The manifold includes a moisture trap to remove water from the air. Seven hooks are spaced around the bottom of the manifold on which the drilling equipment may be hung to be hoisted from the shaft.

At Magma the hose for both air and water are left connected to the manifold; when not in use they are coiled on hooks attached to the bottom of the manifold. When lowered the manifold is connected to the air and water lines with a single hose in each instance. The ends of the coiled hose are dropped to the bottom of the shaft and connected to the drills. While drilling is in progress the manifold is chained to a divider at a convenient distance from the bottom. When drilling is completed and the holes blown out the hose is coiled up and the hoisting cable hooked into a chain on the manifold, which is then hoisted to the sinking level or to a safe distance from the bottom. At the Magma mine the drills are detached and hoisted in the sinking bucket; the manifold is then hoisted to the level and hooked onto a bracket which turns into the shaft. After the cable is detached the bracket, which is fastened to the station set, is turned back into the station where the manifold is out of the way. At the Calumet and Arizona mine when drilling is finished the drills are placed on hooks on the manifold, the hose is tied together with a piece of rope, and all are hoisted to the sinking level, where the manifold is swung into the station by means of a little tigger hoist. In addition to the saving of time, the advantage of hoisting the manifold to the station is that the hose and drills can be inspected and any repairs made without men going into the shaft. At the Magma mine the hose for connecting the manifold to the air line is fitted with a hook clamped to the middle. It is lowered and hoisted by the hoisting cable at the same time that the manifold is handled. The hose for connecting the water line is left connected to the manifold.

AIR AND WATER LINES

Air and water lines should, of course, be large enough so that there is no undue drop in pressure between the supply point and the bottom of the shaft; the size of the pipes will depend upon the depth of the shaft and the number of drills used. Air pipes 2 inches in diameter and water pipes three-fourths inch in diameter are generally used for sinking a 3-compartment shaft and correspondingly larger ones where the demand for air and water is greater. Frequently larger permanent air lines are installed as the shaft is sunk. As room is made extra lengths of pipe are put on, usually at the time that the timbering is done.

HOSE

When the timbering is kept close to the bottom shorter air and water hose for the drills can be used than would otherwise be necessary; 50-foot lengths are used in most shafts. To prevent delays in drilling a good grade of hose is required, but as the hose is not subjected to blasting it need not be armored.

LINE OILERS

Line oilers for lubricating the drills save time and reduce drill repairs. Individual oilers may be used in each air hose below the manifold or a larger one placed on the level where it can be filled by the top lander before each round is drilled. At the Calumet and Arizona mine the manifold is lowered to about 10 feet from the bottom before drilling is begun. The air hose for each drill contains an oiler, about 5 feet below the manifold, which is in reach of the bottom. Each driller keeps his individual oiler filled.

LOADING SUPPLIES IN BUCKETS

In loading buckets with steel or other supplies to be lowered precautions are necessary to prevent men from falling or material dropping down the shaft. At some mines the bucket is hoisted into the station for loading and unloading by a small auxiliary hoist. The general practice is to build a trapdoor or platform which can be dropped over the compartment and on which the bucket rests.

SHAFT ROUNDS

The best type of round and the depth broken per round for any given shaft depend on the character of the rock and the section of the shaft. Rounds seldom can be broken deeper than the width of the shaft. Even in soft ground where deeper rounds would be feasible such a practice probably would result in excessive overbreak. Moreover, in unusually slabby ground still shorter rounds may be necessary to avoid overbreak. In such ground it is sometimes best to break to a section somewhat smaller than that desired and enlarge to full size with moils, leaving the shaft walls solid and free from the shattering effect of blasting. The shaft of the Miami Copper Co., Ariz., was sunk in a conglomerate formation by moiling out the ground with chisel bits in the drilling machines; no explosives were used. As shown in Table 1, the depth of rounds ranges from 4 to 9 feet. Unless the amount of rock broken by the blast must be limited because a fixed routine of sinking operations is being followed, as deep a round as can be broken is usually drilled.

The section of most shafts is large enough that cut holes can be given any desired inclination to obtain the best results in blasting. In ground that breaks with difficulty the first cut holes to be shot should have an inclination of 45° from the horizontal; succeeding holes should be drilled to break into the initial excavation. As in drifts, it is highly desirable that the cut holes break bottom so that a full break of the round can be obtained.

V-cut rounds appear the most satisfactory for rectangular shafts. Where the depth of round is such that the cuts have too much burden to insure a satisfactory break auxiliary cuts or relievers are desirable. In ground that breaks easily single inclined cuts are satisfactory.

In unusually hard ground or in breaking rounds deeper than the width of the shafts the cut holes of the round may be chambered. Chambering weakens the ground to some extent and permits loading of more explosive in the holes where it is most needed. Extra vertical holes may also be drilled and chambered to assist the cut holes in deep rounds. At the Vulture mine 9-foot rounds were broken

for a while in an 8 by 14 foot shaft. A round consisted of 28 holes with four pairs of V cuts. The holes of each pair of cuts bottomed about 3 feet apart, and midway between them a 10-foot vertical hole was drilled. The vertical holes, after being chambered with one-half to one cartridge of 40 per cent strength gelatin, were loaded and blasted with the first delays of the round. Although the charges in the vertical holes had no chance to break much rock the explosive in the chamber shattered the surrounding ground enough that the regular cut holes could break bottom.

Pyramid cuts are favored in small, rectangular shafts and for circular shafts. The detonation of the charges in two or more holes simultaneously, however, is generally undesirable in shafts because of possible damage to the shaft timbers. Where timbering is kept 40 or 50 feet above the bottom, as is sometimes the practice when

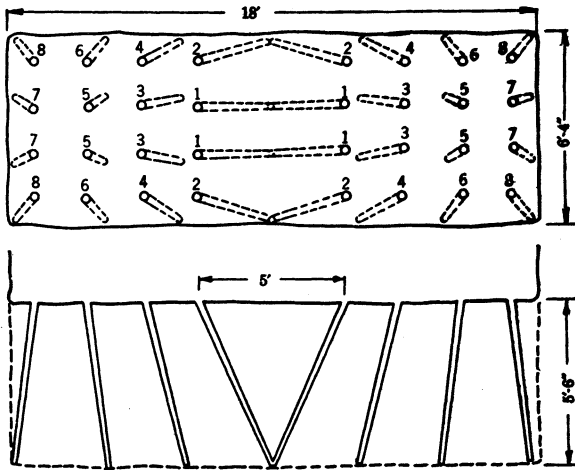

FIGURE 8.—Shaft round used at United Verde mine in medium ground. (Numbers indicate firing order)

sinking is done in hard rock, there is less danger of damage from heavy blasting.

Timber may be broken by blown-out shots or by loading holes too heavily. Care must be taken, therefore, to place the cut holes so that no hole will have too great a burden. Besides the breaking of the ground the rock should be broken into small fragments to facilitate shoveling. To obtain fragmentation a larger number of holes should be drilled and loaded lightly rather than a smaller number of holes loaded heavily. In most shafts cut holes are drilled at such an angle that there is little danger of the explosive blowing large rocks from the collars of the holes upward into the timber.

Figures 8 to 16, inclusive, show rounds representative of those used in sinking metal-mine shafts. Figure 8 shows the V-cut round used in shaft sinking at the United Verde mine. This is typical of metal-mine practice in sinking shafts of this section in medium ground. The depth of round in this instance was such that the broken rock could be removed in one shift. The numbers on the holes indicate the number of the electric delay detonators used in blasting.

A similar round was used in the No. 6 shaft at the Magma Copper Co. except that the round was drilled 7 feet deep and pairs of V-cut holes were bottomed far enough apart that one charge would not detonate the other. Moreover, the rotation in firing the charges was different, as described later. The round used at Magma broke bot-

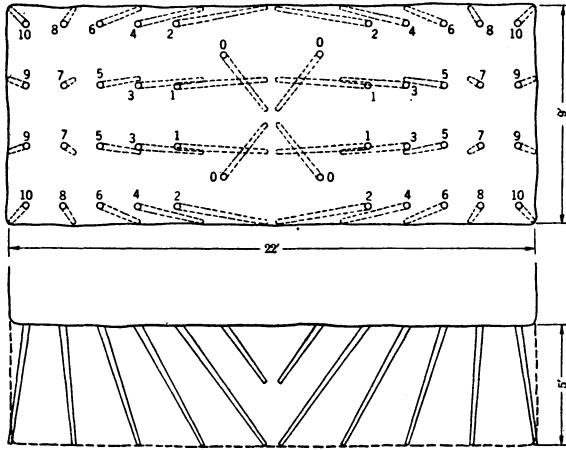

FIGURE 9.—Shaft round, Hecla mine. (Numbers on holes indicate firing order)

tom, but in less favorable rock it is probable that each pair of cut holes would have to detonate together to obtain a full break of the round.

Figure 9 shows a 6-foot round used at the Hecla mine, Burke, Idaho. The four short holes in the center of the shaft relieve the

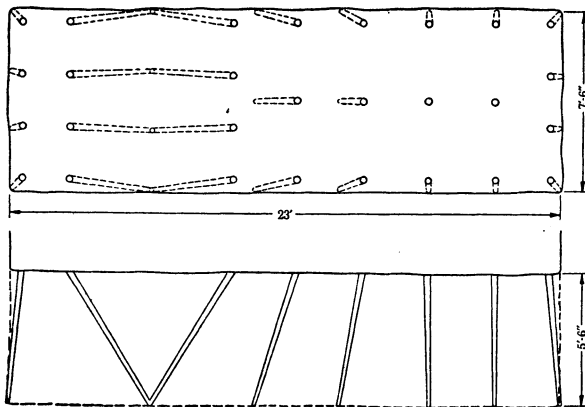

FIGURE 10.—Round used in Guadalupe shaft, Moctezuma Copper Co.

long holes of much of their burden. The four pairs of long V-cut holes may be drilled deeper than the rest of the round to provide a small sump for the suction of the sinking pump.

At the Pecos mine, where a similar round is used, a depression about 18 inches deep is maintained at the middle of the shaft for a sump.

The cut holes may be drilled at one end of a shaft so that the flying rock from blasting is projected partly against the end of the shaft (fig. 10), thus reducing damage to timber.

Figures 11 and 12 show rounds typical of those employed in shafts of large and more nearly square cross section. The former, used at Morenci, Ariz., in easy-breaking ground, could be readily

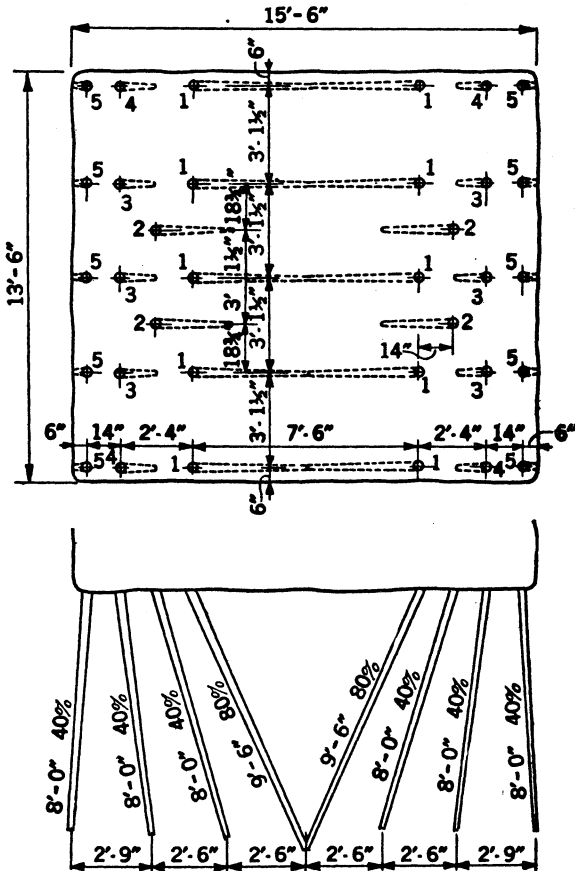

FIGURE 11.—Shaft round in easy-breaking ground at Morenci. (Numbers on holes indicate firing order)

adapted to harder ground by closer spacing of holes or the addition of short cut holes or “relievers.” The round shown in Figure 12 was used at the No. 3 shaft of the Froid mine, Sudbury, Ontario, a large shaft in ground difficult to break. The cut holes were drilled and blasted first. After removal of the broken rock from this operation the remainder of the round was drilled and blasted. When the bottom was reached while the main round was being shoveled out further short holes were drilled and blasted to form a sump at one side of the middle of the shaft.

Rounds for steeply dipping inclined shafts are the same as those for vertical shafts. Where the shaft is of such inclination that mounted drills can be used to advantage the rounds used will be

similar to those for driving horizontal headings of corresponding section in similar ground.

Where it is desired to blast only as much material as can be removed in one shift, or to make a complete cycle in a shift, the round

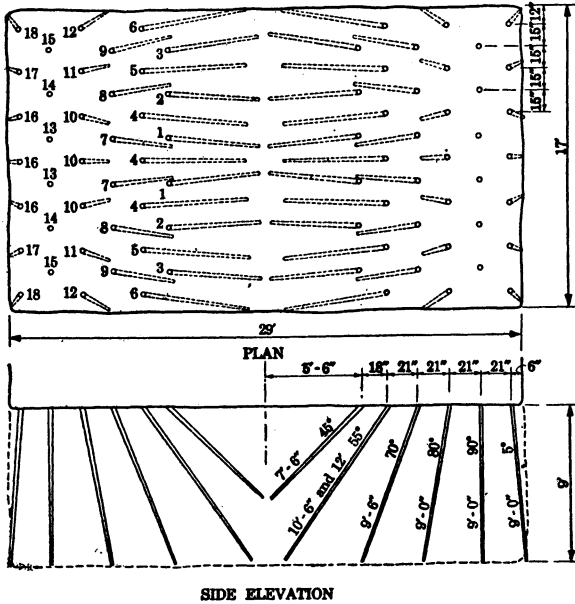
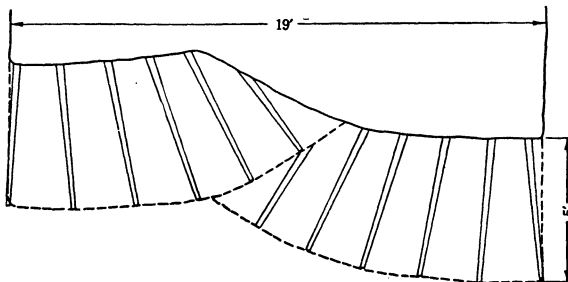

FIGURE 12.—Round used in Frood No. 3 shaft. (Numbers on holes indicate firing order)

shown in Figure 13¹⁷ may be used. This type of round is advantageous where large quantities of water must be pumped, as the low end can be used as a sump while the round is drilled in the other.



ELEVATION SHOWING TWO SUCCESSIVE ROUNDS
FIGURE 13.—Round used in McPherson shaft, Tennessee Copper Co.

Figure 14 shows a similar round for wet shafts of small cross section.

A 12-hole round as commonly used for a shaft of small cross section is shown in Figure 15.

Figure 16 shows a round used in a circular shaft.¹⁸

¹⁷ Weaver, Lamar, Shaft Sinking in Tennessee: Eng. and Min. Jour., vol. 129, Mar. 24, 1930, p. 302.
¹⁸ Nixon, W. G. C., Sinking the Randfontein Ventilation Shaft: Eng. and Min. Jour., vol. 124, Oct. 29, 1927, p. 694.

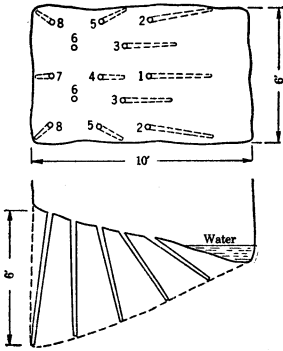

FIGURE 14.—Round for wet shaft of small cross section. (Numbers on holes indicate firing order)

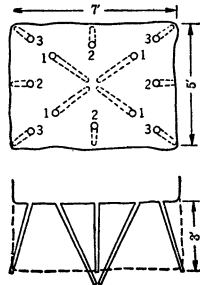

FIGURE 15.—Round for shaft of small cross section. (Numbers on holes indicate firing order)

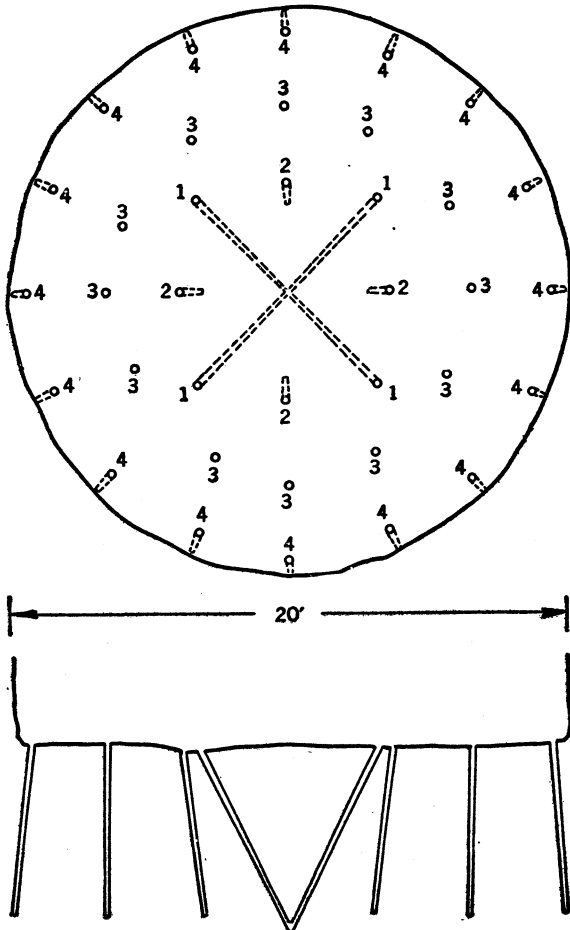

FIGURE 16.—Round used in Randfontein shaft. (Numbers on holes indicate firing order)

A round for an inclined shaft is shown in a recent Bureau of Mines publication.¹⁹

BLASTING

EXPLOSIVES

Blasting in shafts demands greater care in drilling the rounds and a better selection of explosive than in most other development work. Because of its water-resisting qualities gelatin dynamite is usually preferred for shaft rounds. Even where no water occurs in the shaft the water used in drilling is usually sufficient to make the bottom wet.

A grade of explosive that will give the best results in each instance should, of course, be selected. In relatively shallow rounds in ground that breaks easily a 30 per cent strength explosive should prove satisfactory. In ground of medium hardness at least a 40 per cent strength explosive would be needed.

In ground difficult to break 50 or 60 per cent strength explosive may prove more satisfactory than 40 per cent in all of the holes of the round. At Butte and other places two cartridges of 60 per cent strength gelatin are used at the bottom of all holes, and the remainder of the round is loaded with 40 per cent. To break deep rounds 60 to 80 per cent explosive should be used in the cut holes. Eighty per cent was used in the cut holes of a shaft at Morenci to break an 8-foot round in ground that breaks easily (fig. 11). In harder ground than that at Morenci the high-grade explosive may be necessary in all of the holes of the round to break the same depth. If a properly drilled round fails to break with one grade of explosive a higher grade should be employed. Table 1 shows the grades used in shaft sinking at representative mines.

In general, an explosive with a high rate of detonation breaks the rock better than a slower explosive. In some instances substitution of a smaller amount of a higher-grade explosive with a correspondingly greater eruptive force for a lower-grade powder gives greater fragmentation of the rock; as the holes are not as fully loaded there is less likelihood of blown-out shots or of the collars of the holes being blasted up into the timber. In other instances too high a grade may be used for the work to be done. Care should be taken that rounds are not loaded too heavily in ground containing crevices or well-defined horizontal planes of weakness. Instances have occurred where all the holes of a round have detonated together in such ground, thereby wrecking the timber in the lower portion of the shaft.

The explosive in the holes should be well tamped, and the holes should not be more than two-thirds filled in any ground. If the rock does not break with such loading a higher grade of explosive should be used or more holes drilled.

In wet shafts the holes fill with water, which serves for stemming. In dry shafts clay or sand stemming should be used. Stemming not only increases the efficiency of the explosive but in case of a missed hole can be removed with less danger than can the rock fragments that fall into an unstemmed hole.

¹⁹ Vanderburg, William O., *Mining Methods and Costs at the Argonaut Mine, Amador County, Calif.*: Inf. Circ. 6311, Bureau of Mines, 1930, 15 pp.

PRIMERS

All shaft rounds should be blasted with electric delay detonators, as required by law or safety regulations in most mining districts in the United States and other countries. The object is to protect men from being caught in the shaft because of failure of the hoisting equipment after the fuse of a round has been lighted. In any event the best practice demands the use of electric detonators. There is less likelihood of missed holes due to wet blasting caps or to fuse in holes timed to go last being cut off by the first shots of a round to fire. More skill is required to load and wire a round, and if the work is done carelessly or incorrectly more missed holes are likely to result than if fuse and blasting caps had been used. Primers usually are made by the top lander while the round is being drilled in accordance with the head driller's instructions as to number of holes and order of firing. Primers should be made carefully if misfires are to be avoided. The authors recommend that detonators of not less than No. 8 strength be used in all shaft work; their experience has shown that better detonation results when detonators of this strength are used.

At many mines a container with a compartment corresponding to each hole of the round is used for taking the primers to the bottom. As each delay is made up it is placed in the proper compartment. When such a device is used there is less chance of confusion or of a hole being loaded with the wrong delay. There is also a saving of time in loading as the miners do not have to stop to determine the correct delays for the holes. At Butte two box containers are used, one for each end of the shaft. These boxes contain $1\frac{1}{2}$ by 10 inch wooden tubes closed at the bottom end to hold the primers. The tubes are inserted through holes in the cover of the box in a manner to represent the position and inclination at which the holes are drilled for half of the round. If any plugs are to be shot the primers are placed in a third box. Plugging shots are fired with No. 1 delays. At Magma a closed box 5 by 12 by 35 inches is used. Holes for holding the primers are bored in the top cover of the box corresponding to holes of the standard round.

Where practicable, cartridges longer than 8 inches should be used for making primers with No. 7 or higher delay detonators to prevent injury to the detonator in loading the holes. If these can not be procured the primer should be made with two cartridges. In making primers the detonator should not be forced into the cartridges, as the waterproofing may be broken or the detonator damaged to such an extent that a missed hole results. When the explosive is stiff or hard the shell of the cartridge should be cut and a groove gouged out, the detonator laid in the groove, the explosive pressed around the detonator, and finally the paper tied into place with a piece of string. Primer cartridges should be rolled between the hands or on a board to improve the plasticity before being used. Rolling also tends to restore the original sensitiveness of the cartridge, which may have been lessened by age. The primer should be made in such a manner that the detonator will not be pulled from the cartridge while the round is being loaded.

For protection against water the delay detonators should be dipped into some waterproofing compound before being made into primers.

Enough delays should be used in the round to insure the correct rotation of charges. Delays from 0 to 1 to 8 or 10 are generally used in shafts of large section. (Figs. 8 to 10.) Eighteen delays were used in the Frood No. 3 shaft. (Fig. 12.) Instantaneous electric detonators should not be used with the delay detonators, particularly where No. 10 or longer delays are used in the same round, unless it is necessary that the first cut holes fire together to insure breaking the round. At the Magma Copper Co. missed charges were frequent in the holes with the No. 10 delays when the instantaneous caps were used. After No. 1 delays were substituted for the instantaneous detonators no further trouble was experienced with missed holes. When instantaneous detonators are used in more than one hole in a round breakage of timber is likely to be excessive. Opinion differs as to the proper position of the primer in the hole; the authors prefer placing it well down toward the bottom, as they believe that when in this position missed holes due to the charge being cut off are less likely to result.

ROTATION OF HOLES

The usual rotation of firing holes is shown in Figures 11 and 12. In the No. 6 shaft at the Magma mine one hole of each of the two pairs of center cut holes was fired with No. 1 delays and the opposite one with No. 2 delays. The No. 1 detonator in one pair was diagonally across from the same delay in the other pair. Each pair of the side cut holes was blasted with No. 3 and No. 4 delays. The remaining holes of the round were wired so that adjacent holes were fired with different delays in so far as possible with the number of delays used. It is believed at Magma that such a rotation is preferable, as the timber is less likely to be damaged should two charges with the same delays detonate simultaneously. Moreover, better fragmentation apparently can be obtained by this method of firing. As the blasting timbers below the last set 5 feet above the bottom were but little scarred by the flying rock after four rounds this method of firing appears to have merit.

It is desirable to keep most of the charges of the round smothered with loose rock; holes are therefore detonated in such order that the broken material from each shot is thrown over subsequent charges in so far as possible. In some mines the shots at the hoisting end of the shaft are fired last so that shoveling can be started at the bottom of the pile and the bucket be as low as possible. Where the shovelers, because of their number, require all the room available at the bottom this practice is not followed.

WIRING ROUNDS

Most shaft rounds are fired from a lighting circuit of 125, 220, or 440 volts and the holes wired in parallel. Where a blasting machine is necessary the holes are wired in series. In this case greater care is required in wiring, and all connections should be taped. After the wiring has been completed the circuit should be checked from beginning to end to make sure that it is properly done. In any kind of wiring care is necessary to make tight connections and to insure that all possible chances of grounding or short-circuiting the current are eliminated. The authors recommend 440 volts rather than lower voltages and also oversize blasting machines for all shaft work.

Wiring for shooting in parallel is simpler than for blasting the holes in series. Two heavy copper bus wires are strung across the bottom of the shaft, and the individual detonators are connected to both of these wires by twisting one bare end of the leg wires around each of them. Detonators can be obtained with leg wires of two different colors; all the wires of one color are attached to the first bus wire and those of the other color to the second wire. This method tends to prevent the mistake of attaching both legs of a detonator to the same bus wire, thus causing a misfire.

After the wiring at the bottom is completed the bus wires are connected to the firing line running down the shaft. Usually in deep shafts the firing line, consisting of two insulated wires, is extended down the shaft from time to time by the mine electrician. The end of the permanent firing line is kept far enough above the blasting zone to avoid injury. The connection with the bus wires is made with inexpensive wire, which is seldom used a second time. For relatively shallow lifts the lead wires are lowered down the shaft for each blast.

The wires of the firing lines are connected to the wires of the main circuit after the miners are out of the shaft and everything is clear. The round is fired through a safety switch, which is kept locked in an open position. The man in charge of the blasting has the only key to the switch.

At Magma, in preparation for wiring the holes, four stakes are driven either in short holes drilled for the purpose or in "bootlegs" near the four corners of the shaft. The two bus wires are then fastened to these stakes, one above the other, around the two sides and one end of the shaft. The legs of the detonators are then connected to these wires in the usual manner. The advantage of this arrangement is that shorter leg wires from the detonators can be used and that the middle of the shaft where the men work is free of wire. With this method there is less chance of wires from the detonators being inadvertently disconnected by the men while wiring the round.

At Butte the bus wires are supported by two stakes with cross-pieces near the top. This arrangement is locally known as a "fiddle." Each support is made of two pieces of 2 by 4 timber 3 feet long. The bus wires are connected with No. 12 gage copper wire to the end of the firing line, which is lowered down the shaft just before the round is connected up. The firing line consists of No. 12 Tirez insulated wire on a reel, which is kept 10 feet back from the shaft on the station. There are two connections in the side of the reel through which the wires are connected to the main electric circuit of 125 volts. This connection is made just before the round is blasted. In turn, the main current comes through a knife switch, which is kept locked in the open position. The switch is about 100 feet back from the station. The key to this switch box is left in the care of the hoist engineer.

After connecting the main lead wires to the fiddle below, the blasters leave the shaft and next connect the terminals on the side of the reel to the 125-volt line. The knife switch is now ready to be thrown in. One of the shaft men gets the key to the switch box from the engineer; another rings the blasting signal to the main cages, which is answered personally by the station tenders of the

main cages. The man on the level from which the sinking is done is then ready to unlock the box and throw in the switch; the rest of the shaft crew proceed to a safe place to await the blast. After the blast a clearing signal is rung to the station tenders when work is ready to be resumed.

AMOUNT OF EXPLOSIVE PER FOOT

The amount of explosive used per foot of advance ranges from 10 to 70 pounds, depending on the breaking qualities of the rock and the size of the shaft section (see Table 1). An excess of explosive over that required to break the rock generally is used to obtain maximum fragmentation. For this reason more explosive per foot is required to break shaft rounds than to blast raise rounds under similar conditions. At the Bunker Hill & Sullivan mine 12.2 pounds per foot were required to break a raise round in an 8 by 16 foot heading and 23.1 pounds in an 8 by 20 foot shaft in the same formation.

METHODS OF REMOVING BROKEN ROCK

Removal of the material broken by blasting is a major problem in shaft sinking and usually requires more time than all other operations combined.

Mechanical methods of excavating the broken rock have not proved successful, except in the first sections of large shafts being sunk from the surface, mainly because of the restricted area at the bottom and the packing of the blasted material and the large fragments of rock it may contain. Recently, however, the Copper Range Co. at Painesdale, Mich., has been using mechanical scrapers successfully in shafts. Standard excavating machinery is not adapted for work under the conditions existing at the bottom of a shaft. It is possible that a machine could be devised to do the work.

The broken rock must be loaded by hand into containers for hoisting to the surface. Since speed is frequently a factor in sinking shafts as many men are employed to remove the spoil as can work to advantage at the bottom. The best results can be obtained when two compartments are available for hoisting and large buckets or skips are used for receiving the broken rock. In most mines buckets are used, although skips are preferred for some jobs and occasionally the broken rock is loaded into a car. A car may be employed when the waste is to be used for filling stopes. When cars are used the present practice is to shovel the broken rock into auxiliary pans; these are emptied into a car which is lowered on an extension cage. The auxiliary pans may also be used with skips.

Where the hoisting engine has the required capacity, as at the Magma No. 6 shaft, a standard cage can be used to advantage above the hoisting bucket for handling men and supplies in long lifts.

SHOVELING INTO BUCKETS OR SKIPS

In vertical shafts sinking buckets generally are used. When two compartments are available three buckets can be used—one at the bottom, one being hoisted, and one being lowered. At most mines two buckets are used—one at the bottom being loaded and the other being hoisted. When the empty bucket is lowered the hoisting cable is detached and fastened to the other. In a high lift buckets gener-

ally can be filled faster than a small single-drum hoist can take them away. Buckets or skips used for hoisting are stopped by the hoist engineer about 15 feet from the bottom and then rung down by the shaft men.

Buckets.—Sinking buckets of 12 to 26 cubic feet capacity are used in western metal mines. A 60-cubic foot bucket has been used on the Rand. A common type of sinking bucket used at the Calumet and Arizona mine is shown in Figure 17.

Bucket-dumping devices.—Various arrangements are employed for dumping the buckets at the surface or the sinking level. The one most commonly used in United States metal mines is to slide or pivot

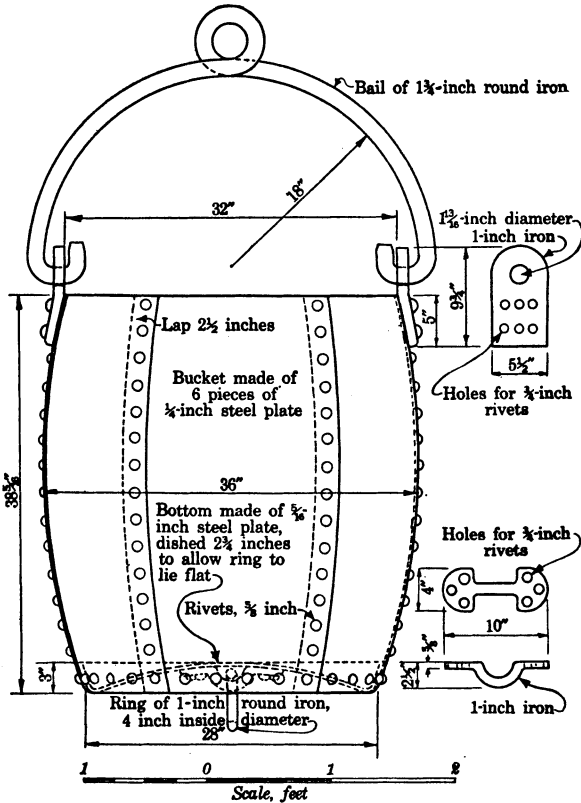

FIGURE 17.—Nineteen-cubic-foot sinking bucket

a chute into the shaft after the bucket is hoisted and then lower the bucket. A ball or a square piece of metal catches into a slot in a metal plate on the chute. As the bucket is lowered the contents are emptied on the chute and pass into a pocket or car. The bucket is then raised, the chute withdrawn, and the bucket lowered. At some places trapdoors are placed below the dumping arrangement to prevent spill into the shaft. Properly constructed and adequately boxed chutes, however, prevent any rock from falling into the shaft.

An improvement in the mechanism for engaging the bucket was devised by A. B. Peach, contractor, in sinking the Vulture No. 3 shaft. Instead of the ball at the bottom of the bucket being en-

gaged into a slot in the chute, a counterbalanced loop of 1-inch iron with a constriction at the lower end swings into the shaft directly under the bucket as the dumping chute is dropped into position. As the bucket is lowered the ball at the end of the chain is held in the constricted part of the hook and the bucket emptied into the chute. This arrangement is positive in its action; with other methods the ball or button occasionally does not engage the slot the first trial.

The chutes may be moved by hand or by means of a compressed-air cylinder. If the hoist engineer has an unobstructed view he usually manipulates the compressed-air dumping device; otherwise it is handled by the top lander.

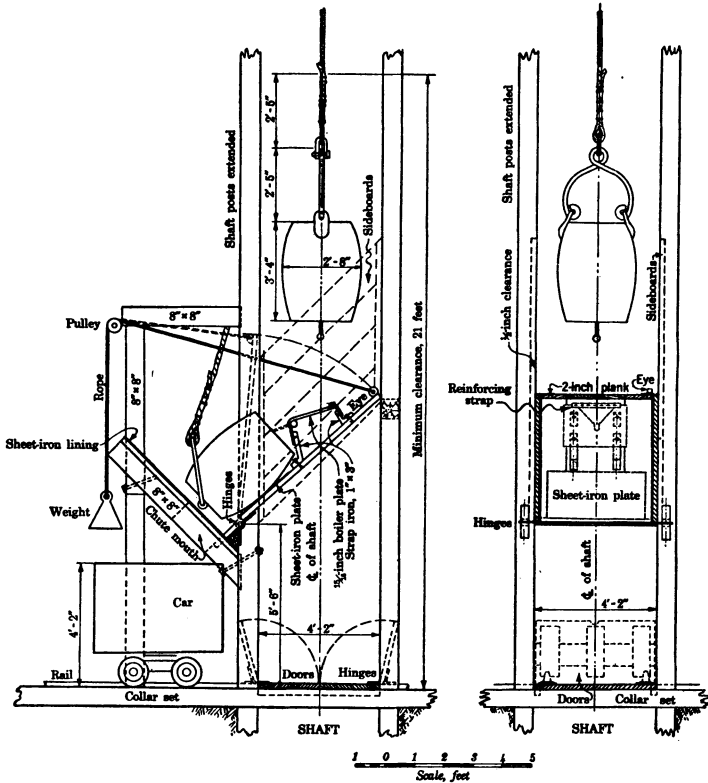

FIGURE 18.—Arrangement for dumping buckets at surface, used by the Walter Fitch, jr., Co., Eureka, Utah

Buckets may be handled at the surface by lowering them onto a truck, which is then run to the dump; or a combination car and bucket may be employed which runs on a track to the dump. The cable may or may not be detached.

Figure 18 shows the standard dumping arrangement used at the surface by the Walter Fitch, jr., Co., of Eureka, Utah. The cost of a similar dumping arrangement at the Christmas mine was \$550.

Figure 19 shows the dumping arrangement used at an underground station at the Engels mine.²⁰

²⁰ Nelson, W. I., Mining Methods and Costs at the Engels Mine, Plumas County, Calif.: Inf. Circ. 6260, Bureau of Mines, 1930, 22 pp.

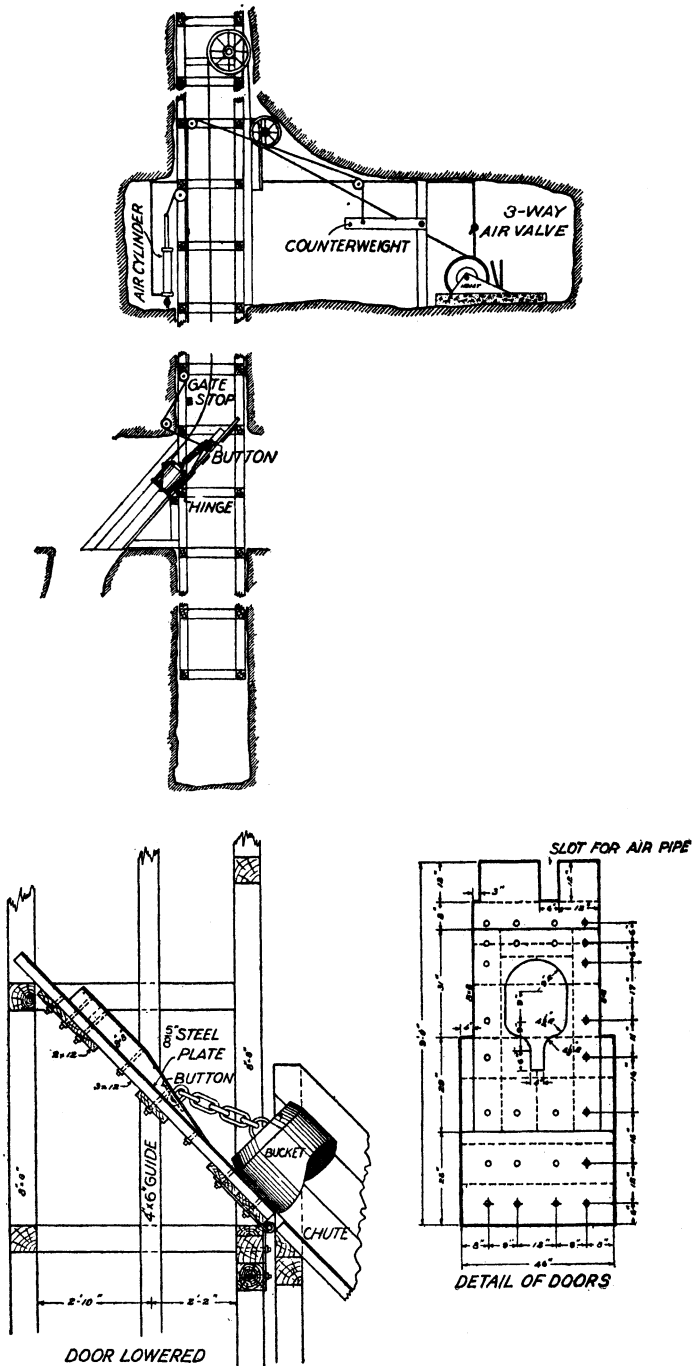

FIGURE 19.—Arrangement for dumping buckets at Engels mine, California

At the Pecos mine, and at some other properties, as the bucket is hoisted the top lander or hoist engineer hooks a chain in a ring in the bottom of the bucket which is then lowered on a trapdoor and dumped.

A device for dumping a bucket with a capacity of 600 pounds, used in sinking a small inclined shaft, is shown in Figure 20.²¹ At the dumping position the widths of the skids are increased to allow the lugs shown on the bucket to drop into notches cut in the skids. As the lugs drop into the notches the hoisting cable is slackened; the bucket is thus allowed to dump. The lugs slide under the strip when the bucket is raised above the dumping position, after which it can be lowered.

Skips.—Skips generally are used in inclined shafts and sometimes in vertical shafts for removing the broken rock. Extension guides

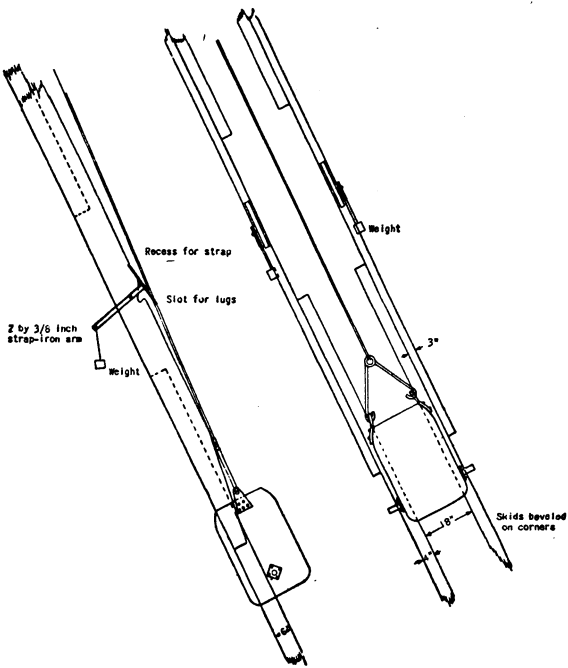

FIGURE 20.—Arrangement for dumping bucket in inclined shaft

or an elongated frame are necessary with skips. Figure 21 shows one of the two skips with a capacity of 3 tons used in sinking the Frood No. 3 shaft. About 42 tons per hour were hoisted, with 25 shovelers working at the bottom. The use of elongated skip frames such as that shown necessitates additional dumping clearance at the surface.

Because of their weight skips are not detached from the cable at the bottom, and one can not be filled while another is being hoisted in the same compartment. The main disadvantages of shoveling

²¹ Heizer, Ott F., Method and Cost of Mining Tungsten Ore at the Nevada-Massachusetts Co. Mines, Mill City, Nev.: Inf. Circ. 6284, Bureau of Mines, 1930, 13 pp.

into skips are their height and the fact that they can not be moved about in the bottom.

Skip-dumping devices.—Skips used for shaft sinking generally are dumped by the standard "cradles" used in operating practice. In vertical shafts a roller near the top of the skip is pulled to one side as the skip is hoisted through the cradle; the skip, which pivots about its axis in the skip frame, is thus overturned. In inclined

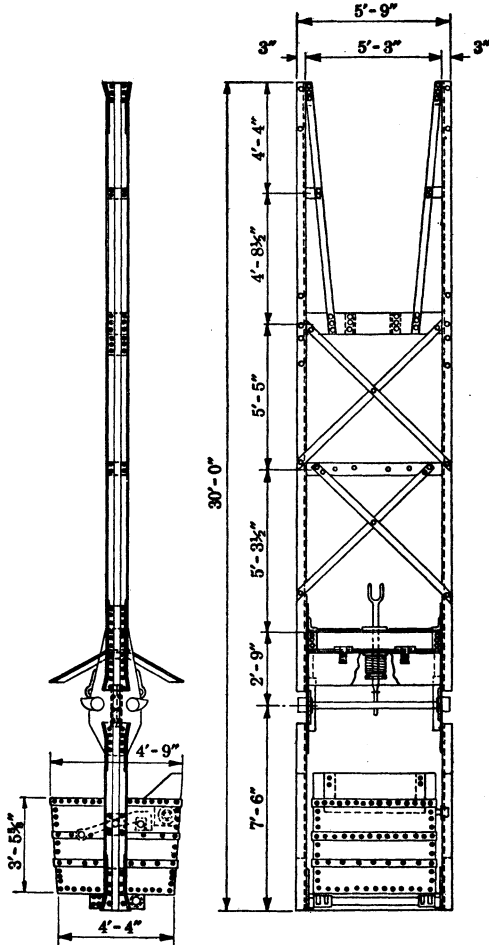

FIGURE 21.—Sinking skip used at Frood No. 3 shaft

shafts the front wheels of the skip follow the track, which is bent down to a nearly horizontal position over the pocket. The rear wheels, however, are provided with extra-wide treads that follow a wider-gage track in the same inclination as the regular track, thus elevating the bottom of the skip and discharging its contents into the pocket. A representative skip-dumping device used in sinking inclined shafts is shown in a recent Bureau of Mines publication.²²

²² Hezzelwood, George W., *Mining Methods and Costs at the Consolidated Cortez Silver Mine, Cortez, Nev.*: Inf. Circ. 6327, Bureau of Mines, 1930, 15 pp.

SHOVELING INTO AUXILIARY PANS

Any device that can speed up the work of shoveling generally is desirable. A plan of shoveling into an auxiliary skip or pan consisting of a shallow steel box and then dumping this receptacle into a car lowered to the bottom on a cage was developed at Butte²³ and has been adopted at other places.

The general layout of the sinking arrangement, with auxiliary pans and cars, used at the Park Konold shaft, Park City, Utah, is

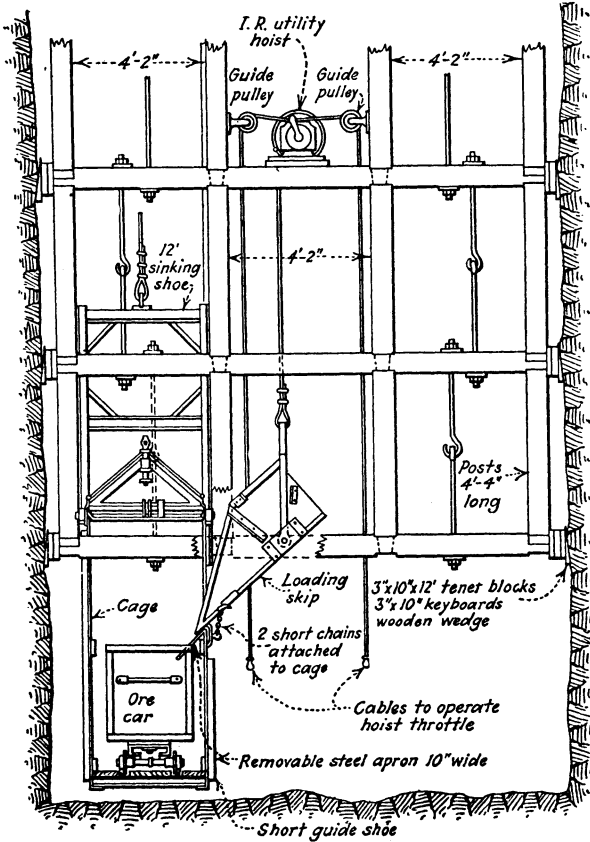

FIGURE 22.—Arrangement for using auxiliary skip at Park Konold mine, Utah

shown in Figure 22.²⁴ The substitution of this device for buckets lowered the cost of sinking one 4-compartment shaft \$5 a foot. At Cananea the adoption of this plan of shoveling increased the rate of sinking 20 per cent. A maximum of 107 tons was loaded out in 8 hours by 6 men; never more than 12 hours was required to clean out the usual 6-foot round.²⁵ At the Pilares de Nacozari mine, by

²³ Drullard, Howard R., Shaft Sinking To-Day at Butte: Eng. and Min. Jour., vol. 123, Feb. 26, 1927.

²⁴ Huttli, John B., Shaft-Sinking Methods at Park Konold and Park Premier: Eng. and Min. Jour., vol. 130, July 10, 1930, p. 23.

²⁵ Catron, William, Mining Practices and Costs of the Cananea Consolidated Copper Co., Sonora, Mexico: Inf. Circ. 6307, Bureau of Mines, 1930, 35 pp.

the same method 6 shovelers handled 1.6 tons per man-hour in a shaft with a 9 by 25 foot rock section.²⁶

At the Morning mine the men shovel directly into buckets until the pile at one end is considerably lower than the rest of the broken rock, after which the pan is used.

The pan is swung to the part of the shaft desired as it is lowered. After being loaded it is hoisted a few feet by means of a single-drum hoist placed on I beams in the shaft, then dumped into a car on a cage or into a skip, which is lowered to receive the load. The pan is designed to hold slightly less than the car or skip so that in hoisting no broken material will spill into the shaft.

Details of pans.—The pan is made of material as light as the service will allow for ease of handling in the bottom and as low as practicable to reduce the work of the shovelers. The pan used at Butte is 48 inches long, 29 inches wide, and 18 inches high. A slightly larger pan was used by the junior author in deepening the North Star shaft.²⁷

A 20-cubic-foot pan used in sinking the Guadalupe shaft at the Moctezuma Copper Co.²⁸ is swung from a bail near its bottom and approximately in the middle of the load. Two angle irons set at an angle on the side of the pan near the closed end prevent the bucket from turning over completely in dumping. When the pan is dumped two hooks fastened to the open end of the pan are engaged in a chute on the cage.

Cages.—The cages used with auxiliary shoveling pans must have extension guides to permit lowering them to the bottom of the shaft and must be of such construction that the pan can be dumped from one or both sides into a car standing on the cage. Figure 23 illustrates the cage used at Nacozari.²⁹ It is of skeleton construction and carries a standard 1-ton, 22-cubic-foot end-dump car. Nine-foot extension guides permit lowering the cage onto the rock pile. The lower guide shoes are flared at their upper end to facilitate engaging the ends of the guides when the cage is hoisted. A chute is fixed to the cage on one side. Short chains on the pan are hooked to the

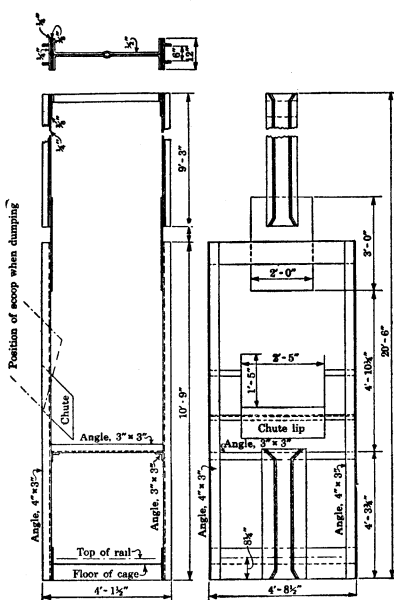

FIGURE 23.—Details of cage used in sinking Guadalupe shaft. (All joints and connections are riveted; standard safety dogs are used)

²⁶ Leland, Everard, *Mining Methods and Costs at the Pilares Mine, Pilares de Nacozari, Sonora, Mexico*: Inf. Circ. 6207, Bureau of Mines, 1930, 35 pp.

²⁷ Johnson, J. Fred, *Deepening the North Star Shaft*: Eng. and Min. Jour., vol. 123, June 11, 1927, p. 960.

²⁸ Leland, Everard, *Mining Methods and Costs at the Pilares Mine, Pilares de Nacozari, Sonora, Mexico*: Inf. Circ. 6307, Bureau of Mines, 1930, 35 pp.

²⁹ Leland, Everard, *Work cited*.

chute as the pan is hoisted, thus tipping the pan and sliding its contents down the chute into the car. The cage is operated from the sinking level, and the cars are transferred at this point.

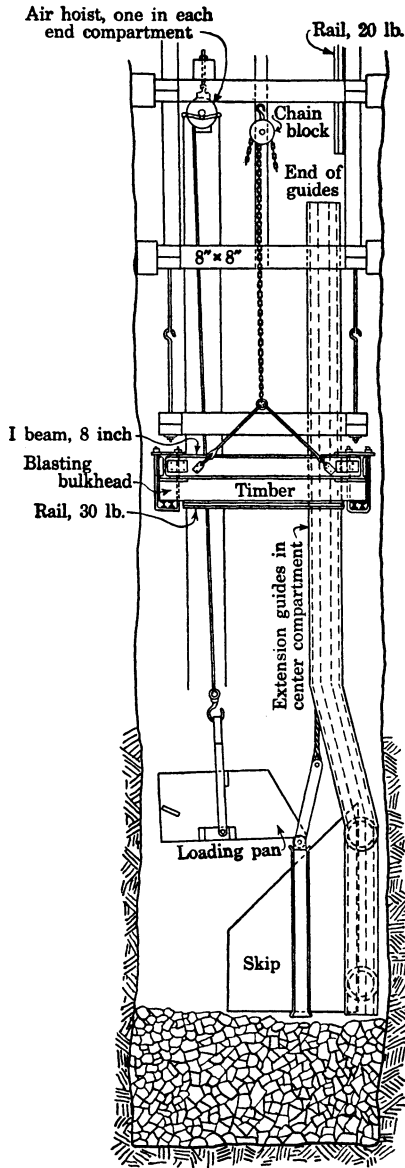

FIGURE 24.—Arrangement for dumping auxiliary pan into skip, North Star mine

space was thus provided for workmen to pass the skip to the other side when it was on the bottom.

Auxiliary hoists.—At Nacozari a small electric hoist was used to operate the auxiliary pan. The men at the bottom operate the hoist by means of two ropes attached to the hoist controls.

With air hoists the control levers for hoisting are operated by ropes passing over pulleys to counterweights. The throttle is held in an off position by the counterweight and must be held open by a pull on the rope. The clutch is held in the engaged position by the spring or counterweight. It is disengaged by a pull on the rope and goes back to the other position as soon as the tension on the rope is relaxed.

Hoisting in skips.—In deepening the Central shaft of the North Star mine at Grass Valley, Calif.,³⁰ the junior author used a different arrangement (fig. 24) for handling the broken rock. A distance of 2,000 feet was sunk without stations, so the spoil had to be hoisted from the bottom the full distance without transfer. An approach at an incline of 45° to the top of the section being sunk made the use of a skip for hoisting necessary; because of the long lift a skip with a capacity of 2½ tons was required (fig. 25).

A guide for the wheels of the skip was designed to be wedged against the lowest set of timbers to take the place of the regular guides below this point. It was 25 feet long and was offset 10 inches to bring the wheels of the skip back under the timbers close to the side wall of the shaft in the center compartment; enough

³⁰ Foote, A. B., Vertical and Inclined Shaft Sinking at the North Star Mine: Am. Inst. Min. and Met. Eng. Tech. Pub. 324, 1930.

A loading pan with a capacity of nearly 1 ton was used in each end compartment. The pans were handled by two 2-ton air hoists above the last set of timber. With both pans full the skip could be loaded in less than 1 minute.

Figure 26 shows the sinking arrangement employed at the United Verde Copper Co. At this mine the spoil is shoveled into an 18-cubic-foot pan; this is dumped into a 38-cubic-foot skip which holds two panloads. The skip has extension guides.

Advantages of auxiliary-pan method.—This plan permits greater speed of removing the broken material where two hoisting compartments are not available for sinking operations. The auxiliary pan

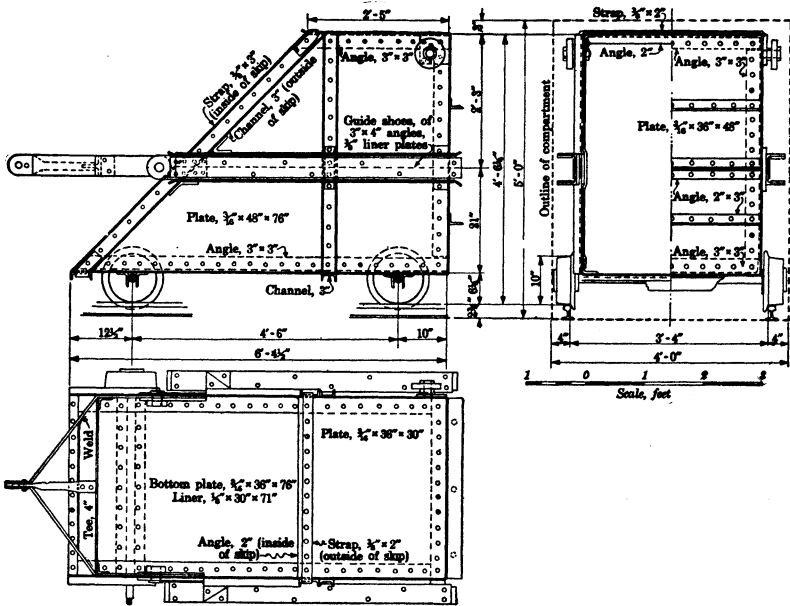

FIGURE 25.—Skip for sinking combination vertical and inclined shaft

can be readily placed at any desired spot in the shaft. Should the last holes of a round throw most of the blasted material at one end of the shaft slides can be placed through which part of the rock can be raked into the pan by picks. Occasionally the pan can be partly loaded by raking the rock directly into it. The dumping of the pan requires only a short time, and a receptacle is always available for the shovelers. Another advantage in operating shafts being deepened is that, as cars can be used and run off at a station, the waste may be used in stopes for filling or dumped into a regular shaft pocket. This practice effects a further saving, as no bucket dump is required.

The plan has no particular advantage where shafts are sunk in relatively long lifts and the shovelers can fill the ordinary sinking buckets faster than they can be hoisted. The use of a skip or car holding two pans of rock requires a relatively large sinking hoist, which may not be practical to install.

Pans can not be used where the condition of the ground requires that timber should be less than 15 feet from the bottom of the shaft.

LOADING BUCKETS WITH MECHANICAL SCRAPERS

Scrapers pulled by small hoists have been successfully used for the last few years in loading the rock broken by blasting in driving drifts. The muck is pulled by the scraper up a metal slide into cars.

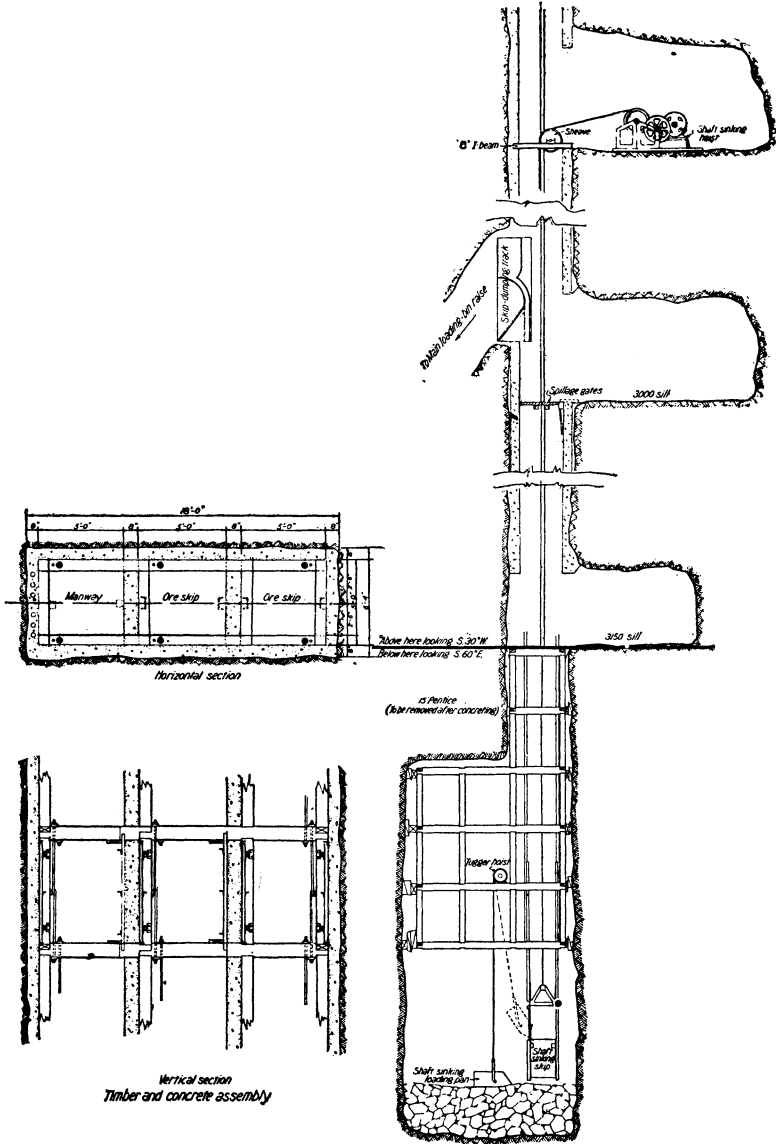

FIGURE 26.—Arrangement for sinking shafts at United Verde mine

Recently the same practice has been applied to shaft sinking at the Champion mine.³¹ The shaft is 10 by 23 feet in cross section and

³¹ Mendelsohn, Albert, Mining Methods and Costs at the Champion Mine, Painesdale, Mich.: Inf. Circ. 6515, Bureau of Mines, Sept., 1931, 16 pp.

has an inclination of 70°. In blasting a round, most of the broken material is thrown into the end of the shaft opposite the hoisting compartment.

The scraper is operated by means of a 25-hp. electric hoist placed on a bulkhead on the timber far enough above the bottom to be safe from blasting. The sheaves for the scraper ropes are fastened to chains strung across the ends of the shaft. The chains are held by eye pins placed in holes drilled at the corners of the shaft at the time the rounds are drilled.

The first operation is to scrape any broken rock from the hoisting end to the other end of the shaft; a slide is then set up as low as possible and the scraper reversed for loading the bucket. The slide is attached by clamps to a stull placed across the shaft. When the bucket is full, a hinged apron of the slide is turned back and the scraper rope pulled to one side to permit hoisting. Two good scraper loads will fill a 1,000-pound bucket in 10 seconds. A larger bucket was contemplated. The scraper is of the hoe type, 30 inches wide, with a 45° angle to the blade.

This method of loading buckets is apparently best adapted to relatively long shafts. In circular or square shafts it would not be as successful and could not of course be used in shafts of a small section.

DROPPING BROKEN ROCK THROUGH BOREHOLE

An innovation was introduced in sinking an 8 by 8 foot shaft 100 feet deep at a coal mine.⁵² The broken rock was dropped into a mine car through a 10-inch churn-drill hole previously drilled from the surface to a level below. A round consisted of four holes drilled to break to the churn-drill hole and eight more holes around the periphery. The crew consisted of two men. Before the blast a plug was placed in the hole below the bottom of the round and afterward withdrawn through the loose material. A 10-inch template placed in the hole after its collar was reached prevented any material too large to fall through from entering it.

This method would be applicable only in relatively shallow shafts from the surface which were to connect to underground workings. The cost per foot should be relatively low, as no mechanical equipment is needed other than for drilling the churn-drill hole and the rounds for blasting.

PUMPING

Even small amounts of water retard shaft sinking, as water makes the muck sticky or causes it to pack. Larger amounts progressively retard all shaft-sinking operations. In amounts up to about 1,000 gallons per 8 hours the water usually can be bailed with the sinking bucket more cheaply than by the use of a pump.

Sinking pumps should be of sufficient capacity to handle any expected flow of water. Not more than one-half of the rated capacity should be expected from a sinking pump. The rating is deter-

⁵² German, W. J., Something New in Shaft Sinking: Du Pont Explosives Service Bull., April, 1930, 4 pp.

mined with clear water, whereas the water pumped is nearly always dirty and frequently gritty.

At the Pecos mine two compressed-air plunger pumps were interchanged after each round to permit inspection and overhauling at the sinking station. There, too, a vertical, electric, centrifugal pump of larger capacity was held in reserve in case of a large flow.

In sinking the last lift of the Campbell shaft about 200 gallons of water per minute had to be handled, and a much larger flow was feared. Two pumps of the plunger type, each having a capacity of 650 gallons per minute, were provided; one was operated constantly except when blasting was in progress, and one was held in reserve. The end of the suction pipe was placed in a depression in the bottom of the shaft and covered with a burlap bag to prevent it from sucking in air when the water level was lowered to such an extent that the intake was not entirely submerged.

As the shaft section was large there was plenty of room to hang both pumps in the shaft; they were suspended by 5-ton chain blocks attached to I beams across the timber. A 4-inch water column was used for each pump. Both were supplied with air from one 4-inch air line. Each pump was connected to the water line by 22-foot slip-joint pipes, thus enabling the line to be extended in 20-foot lengths. At blasting time the suction pipe was detached from the pump and hoisted under the sinking bucket. After the blast the suction pipe was lowered and the upper end pulled up to the pump for connecting by means of a rope block.

Generally the plunger type of pump with a suction hose reaching to the bottom is used in shaft-sinking operations, although centrifugal pumps have been used to some extent. Water containing quartz grit rapidly cuts the valves in plunger-type pumps; under this condition a centrifugal may be more satisfactory. The Christmas Copper Co. found in pumping water containing quartz grit that a hard-rubber valve lasted 4 hours in a plunger pump, a soft one 8 hours, and a medium one 3 weeks.

The exhaust from an air pump is very noisy and occasionally causes trouble by freezing. When the main shaft at the Pecos mine was sunk the exhaust was connected into the water column to eliminate the noise and to prevent freezing.

When a sinking pump of the plunger type loses its suction it is primed, usually by means of a small by-pass pipe from the water column.

For a low head and a relatively small amount of water a vertical centrifugal pump connected directly to a motor proved very satisfactory at the Park Utah mine. The pump was adapted electrically to sinking conditions by Leonard Wilson, consulting electrical engineer to the company. It weighed about 200 pounds and was set directly on the muck pile or the bottom of the shaft. The pump is self-priming where the water is at least 2 inches deep, has a capacity of 175 gallons per minute under a head of 40 feet, and pumps into a horizontal centrifugal pump with a capacity of 175 gallons per minute under a 120-foot head. The second pump in turn raises the water to the level, where it is discharged. The ca-

capacity of the combination is 175 gallons per minute at a depth of 150 feet. Water connections consist of 2½-inch hose in 30-foot lengths.³³

Where a long lift is necessary and a large amount of water is to be handled, sumps, into which the sinking pump discharges, are cut at stations. Station pumps, which are more economical, then handle the water to the surface. In sinking wet shafts lower over-all costs can be obtained by using frequent sump stations.

When water is foreseen in sinking a shaft to connect with underground workings a churn-drill hole in the shaft section will eliminate pumping and thus permit a lower sinking cost. This method, however, is not always successful. In a Wyoming mine an attempt to connect the surface with an underground adit by means of a drill hole before the shaft was sunk cost more than a bid received for sinking the shaft. The holes were deflected in drilling.

The water level in cemented gravel was kept below the advancing face of a shaft sunk at a California drift mine by pumping the water through a churn-drill hole which was put down at one end of the shaft before sinking was begun. The water gained access to the hole through a perforated casing and was raised by a deep well pump.

WATER RINGS

Water running down a shaft usually is collected in water rings and conducted in a pipe to a station sump or to a level below, or if in sufficient quantity it may be pumped from the rings. In constructing a water ring the shaft section is enlarged back of the shaft lining to form a basin. Generally it is lined with concrete to make it water-tight. Such rings usually are constructed below watercourses that have been cut in sinking and continue to flow. If water coming into the shaft is not concentrated at definite points the water rings may be built at appropriate intervals or at levels. Baffle boards are placed under the next set above the ring to catch water running down the timbers. At the Pecos mine a water ring is placed every 100 feet and the water collected and raised to the sump above by means of air eductors. Bearing sets are put in at the same places.

When a section of a shaft is being sunk the part of the shaft in use above may drip considerably. A tank may be placed over the station bulkhead or pentice with another bulkhead above to catch the drip. The efficiency of the sinking operations is thus increased.

SHAFT VENTILATION

After the blast the smoke and fumes must be removed from the bottom before the men return to work. In shallow shafts the gas may be displaced by compressed air from the drilling lines, but this method of ventilation is slow and expensive. One compartment of a shaft may be lined and used for circulating air to the bottom with a fan. In most shafts, however, ventilation is afforded by a small blower forcing air through galvanized-iron or flexible tubing which is carried down as the shaft is extended. Fresh air may be blown down through the tubing or the gases exhausted in the same manner.

³³ Engineering and Mining Journal, An "Electric Sponge" Devised for Shaft Sinking: Vol. 125, May 19, 1928, p. 823.

In most mines the fan is used as a blower, as the bottom can be cleaned out sooner by this method and the men can return to work with less waiting. They may be lowered through the diluted ascending gas without ill effects. The end of the pipe is kept as close to the bottom as possible and still be safe from blasting. When the workmen return an extra length may be connected to blow air directly to the bottom. Tubing 8 to 20 inches in diameter is used, depending on the size and depth of the shaft. A waiting period of 20 minutes to 1 hour, or an average of about 30 minutes, is necessary before the men return to the bottom. At the Campbell shaft of the Calumet and Arizona Mining Co. the pump man returned to the bottom to connect the suction hose and start the pump 10 minutes after the blast.

At the Christmas Copper Co. a 5-hp. blower was used for forcing air through 9-inch tubing down 500 feet. At the Seneca mine a 7½-hp. blower was used with 16-inch tubing.

LIGHTING

Ordinary carbide lamps are used for lighting in most shafts. Electric lighting, however, has the advantage that it furnishes better light with less bother than the carbide lamps. When shafts are sunk in strata that may give off explosive gases approved electric cap lamps or flame safety lamps are used.

At the Engels and Pecos mines light at the bottom is furnished by four 100-watt lamps in a large reflector attached to rubber-insulated drop cord suspended from a reel. The light is disconnected and raised before the round is loaded to avoid stray electric currents.

SHAFT SUPPORT

Shafts are lined for two purposes—to support the walls and to afford support for guides, ladderways, and service pipes and wires. In rock that stands well the second purpose may be the only reason for timbering. It is of paramount importance that shafts be lined in a workmanlike manner and timber kept in line to prevent later trouble in the shaft. Most shafts are timbered in sinking whether or not they are to be concreted later. In most instances the timber is removed as concrete is poured; occasionally, however, it is left in and the concrete placed around it. Steel sets, if used, ordinarily are placed as the shaft is sunk.

Timber lining costs less than either steel sets or concrete and for this reason is used in most metal-mine shafts. In important coal and nonferrous metal mines, where the scope of operations justifies the expense, main shafts usually are concreted. Steel sets are less expensive than concrete but cost more than timber; these are used in important shafts in iron mines.

With respect to cost of maintenance and reduction of fire hazard concreting is preferable to timbering in main shafts. Concrete is also desirable where large tonnages are hoisted, as the spill from loading and dumping cuts and bruises the timber, which in time has to be replaced. Concrete linings are also more rigid and are less likely to get out of alignment. Moreover, concrete shuts out air and moisture, which cause some kinds of rock to slack; in such ground con-

crete is better than timber. Water in soft strata that may otherwise stand well often causes weathering and erosion of the shaft walls; falls of rock result, and the timber is forced out of line. Under such conditions concreting is preferable. Concrete, however, should not be used in moving ground, as it will be crushed by the rock movements and is awkward and expensive to replace. In such ground timber is preferable, as it can be replaced when broken and workmen can get back of it to ease off the pressure from swelling or moving ground. For example, trouble developed in a concreted section of the Morning shaft soon after the lining was placed and gradually increased in spite of repairs. To date (April, 1931) 200 feet of the reinforced concrete have been removed and replaced with jacketed timber sets. When this work is completed the remaining concrete in the shaft is to be replaced. Shaft concreting at the Morning has been a complete failure.

Steel sets are fireproof and have a longer life than timber, except where places are exceedingly wet or where the water is acid. Gunite is used as a partial shaft lining in some mines.

In the early days of mining permanent shafts were sometimes lined with masonry or brick; however, since concrete has come into general use it has almost entirely replaced the older and more expensive form of lining.

TIMBER LINING

As shown in Table 1, timber shaft sets usually are made of 8 by 8, 10 by 10, or 12 by 12 inch timber; 20 by 20 inch material is used in one shaft (the Argonaut) in very heavy ground. The size of the timber used depends on the requirements for supporting the ground and the use to which the shaft is to be put. If large skips operating at high speed are to be employed more substantial timbering will be required to withstand the shock and vibration caused by the rapidly moving skips than where the hoisting is to be done in small skips.

Shaft sets ordinarily are placed on 5-foot centers, although in some places they are placed on as great as 7-foot or as little as 4-foot centers. In bad ground the shaft may be cribbed solidly with 10 by 10 or 12 by 12 inch timber.

Inclined shafts may be timbered only with sills or stulls on which the skip track is laid, but in vertical or nearly vertical shafts in which guides are used regular sets are nearly always placed, whether or not the ground needs support. In the Tri-State district, where hoisting is done in 1,000-pound "cans" (buckets) from relatively shallow depths, 2 by 4 or 2 by 6 inch cribbing in the parts of the shafts needing support is the only timber used.

Methods of placing timber.—Timbering in ground that tends to slough is put in after the round has been loaded out and usually is kept near the bottom. The lowest set seldom is placed closer than 5 feet from the bottom, except in extra-heavy ground. This distance is convenient for the timbermen to block the set. In many mines the timber is placed before shoveling is started, and the men stand on the broken rock to place the set. At the Hecla, where long rounds are drilled shoveling begins after blasting and continues until enough of the broken rock is removed to make room for the set,

which is then put in. After the timber is placed the rest of the round is loaded out.

If speed is important timber may be placed by a special crew while the round is being loaded out or other work is in progress. A suspended platform is used in the shaft on which the timbermen work; this can be designed to protect the workmen in the bottom from falling objects.

As previously stated, in firm ground the timber may be kept 40 or 50 feet above the bottom, the distance depending mainly on the condition of the walls. The practice at some mines is to put in two, three, or four sets at a time. The number of sets that can be placed in a shift depends mainly on the organization of the operations and the method of paying the men. Although placing one set is considered a shift's work when on company time skilled shaft men working under a bonus plan frequently place two or three and sometimes four sets in a shift. If the work is well organized the men will not have to wait for the timber, and the best equipment will be furnished for doing the work.

Timbering practice at metal mines in the Southwest is illustrated at the Magma Copper Co., Superior, Ariz. In sinking No. 5 shaft in firm ground three or four sets were placed at a time while other work in the shaft was suspended. Wall plates were lowered one at a time by the hoisting cable, which was attached to the end of the timber by means of a clevis. The clevis pin went through the hole bored near the end of the timber for a dowel. A length of cable with a threaded piece of pipe socketed on one end and a loop on the other was used for hoisting the wall plates in place. The threaded end of the cable was placed through the center hanger-rod holes of the wall plates of the last set in place and one of the wall plates at the bottom. A nut on the threaded pipe secured the bottom timber. The hoisting cable was then hooked into the other end of the special cable and the bottom wall plate raised 4 feet 8 inches, which corresponds to the distance between the sets. Another wall plate was attached to the first by means of the end hanger bolts; this procedure was repeated for the third and fourth wall plates. Next the lot was hoisted in place and hung onto the last set by means of the hanger bolts. The wall plates for the other side were hoisted in the same manner and attached to the set. A working platform was then built with lagging across the second pair of suspended wall plates. After the wall plates were hoisted the cable was attached to a square bucket which held four posts or dividers and contained a supply of tools, wedges, and blocks. In this bucket the rest of the timber was lowered to the position in the shaft where it was needed. The first set was then completed and blocked into place, the platform moved down, and the next set placed. The last of the series was blocked with the men standing on the bottom of the shaft.

Sets can be blocked tighter by placing one block sidewise with the grain. The wood compresses more in that position than when endwise with the pressure. For maximum pressure on the sets the ends of blocks can be split and wedges driven in. All sets should be fitted on the surface to make sure the different members are correctly framed.

Method of placing lagging.—Figure 27 shows a common method of placing the lagging outside the sets.⁸⁴ Cleats made of 2 by 2 inch lumber are nailed to the middle of the outside of the wall and end plates after the sets are framed to hold the vertical weight of outside lagging until the set is blocked. A so-called keyboard consisting of 2 or 3 inch lumber the same width as the wall and end plates is placed back of the sets to hold the lagging in place. At the Eighty-Five mines the keyboards are nailed to the timbers before being lowered.

At the Magma mine the keyboards are held in place while the set is being placed by means of a pin of tool or hard-rolled steel passing through the eyes of clevises that fit over the wall plates. After the set is blocked the clevises are removed.

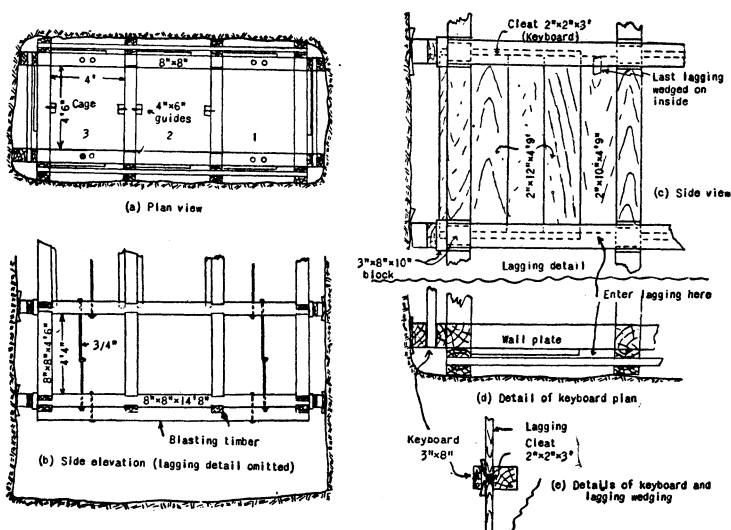

FIGURE 27.—Arrangement of timbering and keyboard lagging, Eighty-Five mines

The sets are blocked at the corners and at the ends of each divider in the usual manner. Short pieces of 2-inch pine lagging are placed between the keyboard and the sets at the blocking points. The cleats reach across each compartment except 12 inches at one end. The lagging, which is 2 inches shorter than the center-to-center distance of the set, is introduced between the timber at the short end of the cleat in each compartment and then pushed sidewise into place over the cleat. The last lagging placed in each compartment is secured in place by a wedge. The other lagging also may be wedged in the same manner. The keyboards are rarely knocked out or loosened by blasting. In addition, they hold the lagging securely in place and prevent it from becoming loosened and falling down the shaft.

At the Saginaw shaft of the Calumet and Arizona Mining Co. the lagging is held in place by two cleats nailed on the top and bottom of the wall and end plates. The lagging is introduced in

⁸⁴ Youtz, Ralph B., *Mining Methods at the Eighty-Five Mines, Calumet and Arizona Mining Co., Valedon, N. Mex.*: Inf. Circ. 6413, Bureau of Mines, 1931, 26 pp.

the same manner as when a keyboard is used but is between rather than back of the shaft timbers.

One cleat may be used back of the lagging, which is then toenailed to the timber. This form of lagging is considered to strengthen the sets when blasting is done near the timber. The lagging is not as secure as when keyboards are used but has the advantage of being easily replaced.

In places where spill is excessive the timber of the hoisting compartments may be protected by lagging placed in the manner just described but flush with the inside of the sets. In the Colorado mine at Cananea the shaft sets are protected from spill by angle irons placed flush with the edges of the wall plates and dividers around the hoisting compartment.

Blasting sets.—The bottom set in a shaft is protected from flying rock by blasting timbers attached to it. The blasting set is detached and lowered or dropped to the bottom before the new timber is lowered. It consists of unframed timbers the same length and width as the horizontal members of the shaft set. At the Calumet and Arizona the blasting set is attached to the shaft set by two pieces of 1½-inch square iron bent to fit over each wall plate at the end of the shaft. The other ends of the irons are bent to hold an 8 by 10 inch timber lengthwise of the shaft 8 inches below each wall plate. Six by eight inch timbers are then placed across the shaft under the end plates and each divider and on top of the lengthwise pieces; they are made fast by wedges driven between the lengthwise and crosswise members. The ends of the irons are bent up 2 inches, which leaves room to slide in the first timbers of the blasting set.

At the Magma, Eighty-Five (see fig. 27), and other mines the blasting set is attached to the shaft by bolts through the hanger-bolt holes. The crosspieces are placed in a manner similar to that described. When the rock is hard and blasting heavy the bottom of the blasting set may be sheathed with iron plate. At some mines the blasting set consists of only two timbers chained to the wall plates a few inches below them. The end plates and dividers are protected by lagging nailed on the lower side.

The junior author favors the use of a suspended bulkhead instead of a blasting set attached to the shaft timbers, as the timbermen can work on the bulkhead to place sets while sinking crews are engaged at the bottom. (Fig. 28.) The bulkhead is nearly the same size as the excavation with only enough clearance to permit its being lowered readily by means of 1-ton chain blocks rigged from temporary timbers two or three sets above. The bottom of the bulkhead is shielded from blasting by ¼-inch steel sheets bolted to the underside of the main members. In hard ground further protection is necessary; a solid layer of 6 by 8 inch timber fastened under the bulkhead by means of steel rails and U bolts (see fig. 28) effectively serves this purpose.

If sinking pumps are used they must be protected from blasting. Usually bulkheads of 8 by 8 inch timber are built across the compartment in the set below the pumps. At the Engels mine a combination blasting set and timbering platform was used. The part of the platform below two compartments consisted of 8 by 8 inch timber, which protected the pump and provided storage for machines

and equipment. The platform was lowered by means of the hoisting cable at one end and chain blocks at the other. It was held in place by $\frac{3}{8}$ -inch sling chains with grabhook ends.

Bulkheads and pentices.—When working shafts are deepened the sinking operations are usually carried on through the manway compartment. The sinking crews must be protected from the spill from the loading of skips above and from other objects that might fall down the shaft. For this purpose either a section or pentice of solid

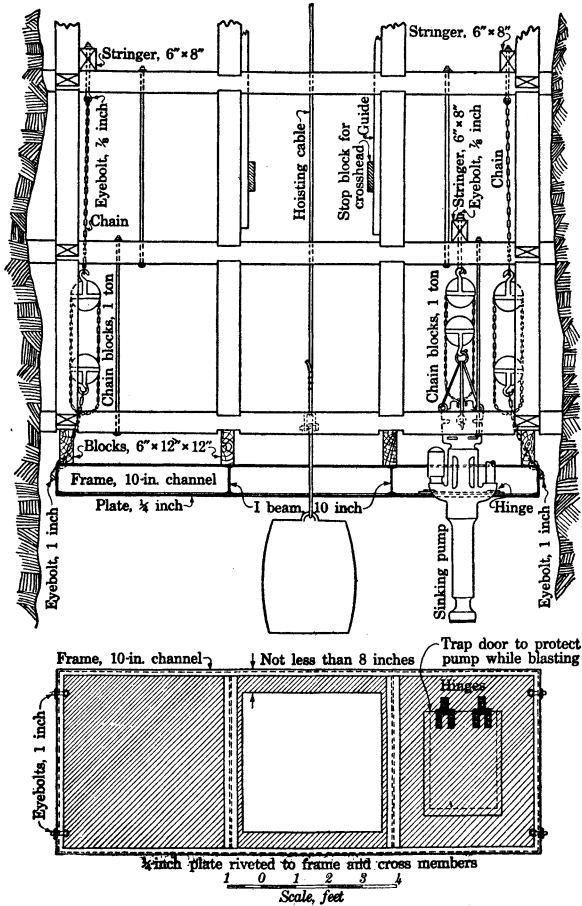

FIGURE 28.—Suspended bulkhead used for shaft sinking by Walter Fitch, Jr., Co.

rock may be left below or at the level from which the sinking operations are conducted or a bulkhead may be built across the shaft. Where skips are used for hoisting from the sinking level the pentice is left or the bulkhead is built below the loading pocket. Where no regular hoisting is done from this level bulkheads may be built above.

Bulkheads are made of one or more solid layers of large timber laid across the main hoisting compartments, generally reinforced

from below by angle braces. Filling two to four sets of the shaft with broken rock on top of the bulkhead will afford further protection from the danger of a skip or cage falling in the upper part of the shaft. The sinking compartment is lined above the level and bulkheaded above the bucket-dumping device.

Pentices are 10 to 25 feet thick, depending on the character of the ground. Figure 26 shows the use of a pentice at the United Verde Copper Co. Here the sinking hoist is on the level above the sinking level; and the waste is dumped into the main shaft pockets, from which it is hoisted in the main skip.

At the Consolidated Cortez silver mine a 6 by 12 foot inclined shaft was deepened 120 feet to open a new level. Shoveling in the shaft was done on night shift, using the regular 20-cubic-foot ore skips, and drilling was done during the day shift while ore was being hoisted. To protect the men in the shaft a bulkhead was built below the skip-loading pocket, with a trapdoor to permit passage of the skip when rock was hoisted from the shaft bottom. While ore was being hoisted this trapdoor was kept closed, and supplies were taken into the shaft by way of a sublevel 20 feet below the bulkhead.

Bulkheads built in the shaft and moved downward as sinking progressed are also used to protect the workmen from falling objects. These are built only in compartments through which no buckets or cages are operated. At the Morning mine such bulkheads are kept 40 to 100 feet from the bottom and cover all compartments except the end one, through which the waste is hoisted.

Timber shaft sets.—Oregon fir usually is the wood most favored for shaft sets, as it is stronger and lighter and resists decay longer than most native timber. Where a mining company is using this timber for general mining purposes selected timber is generally used for shafts. On account of resistance to decay Port Orford cedar or redwood is used at some western mines in shafts where long life is desired and where great strength is not required or where there is to be no wear from spill in hoisting. Hardwoods are used in some eastern districts.

Timber in shafts is subject to decay. Treatment with a preservative prolongs the life of the timber very materially. Creosote preservatives are not washed out by water but have a strong, disagreeable odor when first installed and may increase the fire hazard. The workmen dislike to handle such timber, as it may cause burns. Whether creosote increases the fire hazard or not is a debatable question; however, to be on the safe side, if creosoted timber is used it should be fireproofed by guniting. At some mines zinc chloride preservatives are preferred for shaft timbering, although water may reduce their effectiveness.

Shafts sets are usually framed by hand, as the number used in most mines does not justify installing a special framing machine. Power saws are customarily used for cutting the timber to the proper lengths. Owing to variation in the size of timbers and to warping, all dimensions for cutting mortises and tenons are marked on only one side of each timber. Uniformity of framing is obtained by the use of wooden templates.

The method of framing shaft sets is more or less standard. The Magma Copper Co. uses a method that is representative of the prac-

tice in most western metal mines. (Fig. 29.) Wooden dowels are driven through the holes bored at the ends of the wall and end plates as the sets are placed in position.

Figure 30 shows the timbering details of a shaft at the Teck-Hughes mine in Ontario.

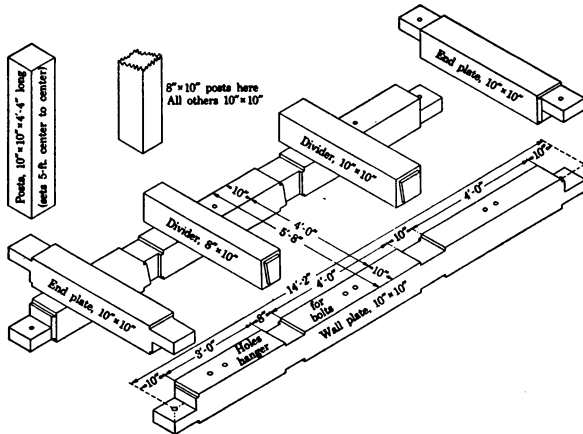

FIGURE 29.—Shaft set, Magma mine. (All daps, 1 inch; corners fastened with wooden dowel pins)

A simpler method of framing at the corners of the sets, as used at the Black Rock mine, Butte, Mont., is shown in Figure 31.

The more elaborate framing shown in Figure 29, although more costly to frame, is easier to install, as there is less likelihood of the set getting out of square while the timbers are being placed. After

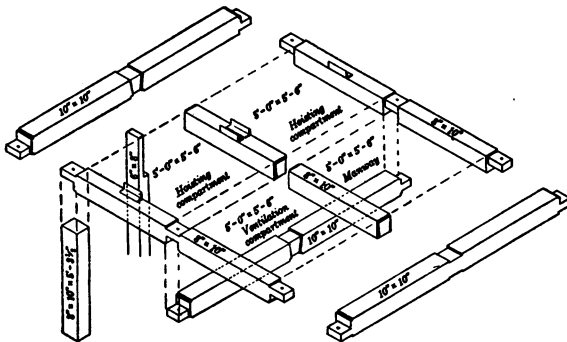

FIGURE 30.—Sets at South shaft, Teck-Hughes mine

the wall plates are hung the end plates can be placed and dowel pins driven in. This squares up the set and holds it together. The dividers can then be dropped into place, the posts stood, and the whole set drawn up in place by tightening the hanger bolts. The set now can easily be aligned and plumbed. Less-elaborate framing should, however, prove satisfactory in some instances.

Apparently shaft-timbering practice could be improved in many cases by a better proportioning of the dimensions of the timbers. Posts can usually be framed of lighter timber than the horizontal

members of the set, as their main purpose is to act as spacers and not to take any ground weight. In heavy ground dividers should be at least as large in cross section as the wall plates.

Figure 32 shows the framing for the heavy timbers used in the Argonaut shaft. Posts are used only at the four corners. As the

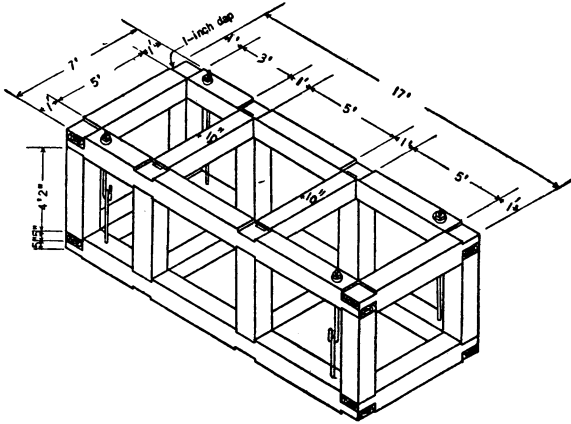

FIGURE 31.—Standard shaft set, Black Rock mine, Butte & Superior Mining Co.

Argonaut shaft is inclined the maximum pressure is withstood by the top wall plate. The framing used is simple, and the wall plates are weakened to a minimum extent.

Figure 33 shows the framing for timbering an 11 by 12 foot ventilation shaft at a coal mine. Redwood timber is used through-

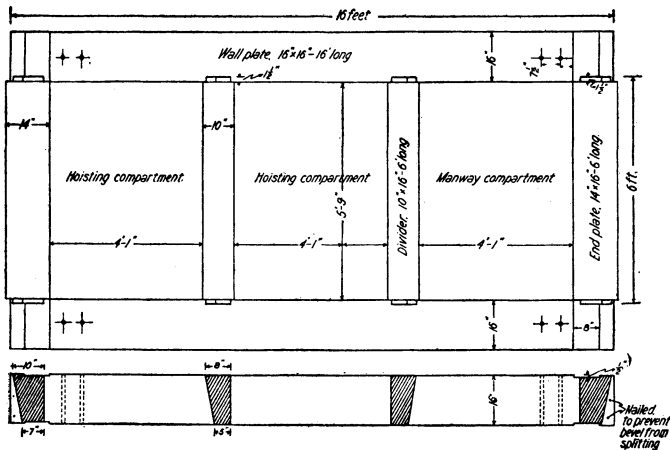

FIGURE 32.—Sets at Argonaut inclined shaft

out. As the shaft is used solely for ventilation the framed sets for supporting guides are not required.

Bearing sets.—As timber sets are put in place they are hung to the next set above with iron hanging rods $\frac{3}{4}$, $\frac{7}{8}$, or 1 inch in diameter. These rods also tie the sets together and prevent settling of sets

should the blocking become loose. However, a long section of timbering may settle as a unit unless the vertical weight is otherwise sustained; bearing sets are therefore placed to provide such support. Sills used in timbering stations usually serve as bearers, and if stations are cut as the shaft is sunk no other support may be needed. In sinking long lifts, however, bearing sets are usually placed at intervals of 70 to 200 feet. At the Engels mine bearers were placed every 72 feet, at a Mesabi range iron mine every 106 feet, and in the Magma No. 6 shaft every 200 feet.

In general, timber for bearing sets is the same size as that used for wall plates. The bearing timbers are placed across the shaft under each cross member of the set. Hitches are cut into the side walls of the shaft to allow the ends of the bearing timber to rest on solid ground. In hard ground a bearing of 6 inches to a foot under the ends of cross timbers may be sufficient; in soft ground 2 or 3 feet may be necessary. If the bearing timbers extend far past the sets

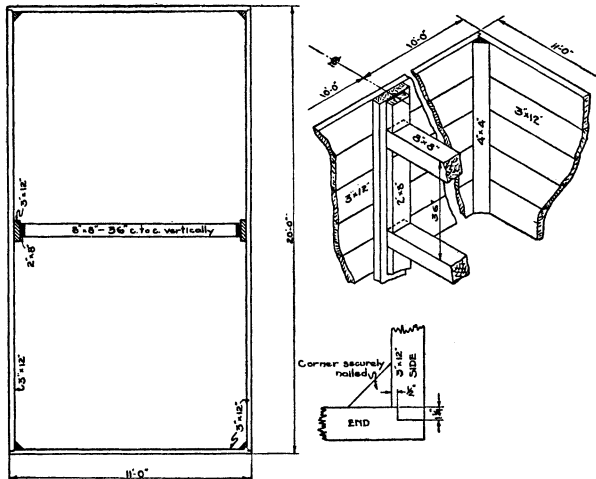

FIGURE 33.—Shaft timbering, Rock Springs mines Nos. 4 and 5, Union Pacific Coal Co., Wyoming

short stulls may be placed under them, outside the wall plates, to give added stability. Occasionally a hitch is cut entirely around the shaft, and sills of wood or steel or a concrete base are laid for supporting the bearers.

The posts of the next set below the bearers are cut shorter, the decrease corresponding to the thickness of the bearing timbers. The posts are dapped into the bearers. Usually a bearing set can be placed in a shift by a shaft crew. After a bearing set is installed the hanging rods above may be taken out and reused.

Timbering in moving ground.—Shaft timbers in moving ground must give the shaft maximum support and should be placed so that broken timbers can be replaced without interfering with other operations in the shaft. Blocking, which will crush before the sets break, should be used back of the sets. Cedar blocks put in sidewise have proved useful for this purpose. In moving ground jacket sets may be used around the regular shaft timbers. The use of long blocks or jacket sets provides space back of the sets where workmen can ease the

rock pressure before the timber breaks; also the shaft timber can be repaired without interfering with hoisting. Jacket sets around a cribbed shaft, as used at the Butte & Superior mine, are shown in Figure 34.

At the Morning mine, as mentioned before, a section of the shaft had been lined with reinforced concrete which failed and had to be removed. The section was then lined with 93 jacket sets at a cost of

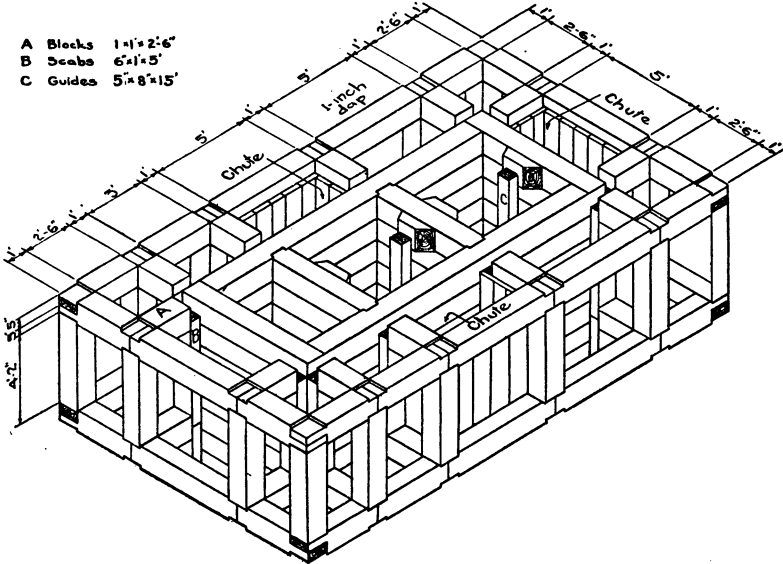

FIGURE 34.—Jacket set around cribbed shaft, Butte & Superior mine

\$347.69 per set, or \$69.54 per foot. The sets were similar to those used at the Butte & Superior mine. (Fig. 34.)

Timbering in moving ground at the North Lily shaft, Eureka, Utah, is described by Finlay as follows:⁸⁵

This 4-compartment shaft, sunk from surface in rhyolite, ran into trouble almost at the grass roots. Large slabs slid in along wet slips, causing trouble and delay for 50 feet, when enough solid ground was found to put in bearing sets. Ten feet below the bearing sets the shaft bottom fell into an open cave—the bottom being mud and boulders. Sinking through this, the hanging rods pulled apart and the timbers settled.

For a considerable distance the west side of the shaft was fairly solid, and angle-braced jacket sets were put in 4 feet back of the wall plates on east side. This also settled and a system of stulls across the shaft was tried. The shaft posts were removed and stulls put across the shaft from hitches on west side to horizontal stringers, with vertical lagging behind them, 3 feet back of wall plate on east side. Between shaft sets eight stulls were placed—four sets of double stulls. On the west side the stulls were in the same hitch, one above the other. On the east side the lower stull and stringer was 1½ to 2 feet higher than on the west side, and east end of upper stull still 2½ feet higher, so that settling of stringers and lagging would tighten the stulls. A 5 by 10 inch crushing block was placed between each stull and stringer to give warning in case sufficient weight developed to break the stulls.

This scheme worked so well that an inspection several months after placing the stulls showed them to have settled 6 inches on the high end, the blocks to

⁸⁵ Finlay, J. S., The North Lily Shaft at Eureka, Utah: Min. Cong. Jour., September, 1928, p. 698.

be crushed a maximum of $\frac{3}{4}$ inch, and that the shaft timbers had not moved. Blocking was placed above the stulls but none below, allowing the stulls to settle without pushing the shaft timbers with them.

At a depth of 450 feet the west wall of shaft dipped west and spoiled the hitch and stull scheme. For 100 feet we put in stringers and lagging behind the wall plates on both sides, holding them apart with stulls placed as high as possible above the wall plates, hoping to strike solid bottom before they settled enough to push the timbers down. However, the settling was so rapid that it was necessary to keep sills on the mud bottom with posts to the shaft timbers, working down a small hole, changing posts as necessary.

Nearly 100 feet of timbering was on the move, and chunks of mud and rock falling down the shaft from openings caused by the movement made it a rather wild job.

When solid limestone was reached, bearing posts were put in and sinking was stopped until the settled shaft sets were jacked up and straightened. This was done with machine bars and two 25-ton jacks. When this job was done and made secure, with posts from the solid ground up through the soft ground, sinking was continued to a depth of 1,240 feet without further difficulty.

Sand filling around sets.—A method of filling the space back of the timbers with sand, devised by the junior author, has proved very successful for preventing broken or twisted sets in swelling ground. The vacant space back of the shaft timber is filled with fine sand, which acts as a cushion and at the same time prevents moisture and air from coming in contact with the shaft walls. The first operation is to align all shaft sets and to replace all old lagging with new 3-inch boards. The space between the lagging and shaft walls should be nowhere less than 8 inches. Each set is kept in line temporarily with wooden blocks and wedges, which are knocked out as the level of the sand rises. The only equipment necessary for the filling operation is a wooden trough, with a screen attached to the open end, placed on a slight angle at the mouth of the shaft, and a 2-inch pipe line, to one end of which is fitted a sheet-iron hopper, installed in the shaft. Fine sand is shoveled into the trough and with an excess of water is washed into the hopper and then conveyed to the bottom of the shaft; here an operator, with the aid of a rubber hose attached to the 2-inch pipe line, distributes the sand evenly behind the lagging. The water from the sand collects in the sump of the shaft and is pumped back to the surface through a centrifugal pump. The pump parts wear rapidly because of the fine sand particles contained in the water. The saving effected by the use of the method, however, more than counterbalances this expense.

In sinking the Hecla shaft at Burke, Idaho, from the 2,000-foot level to the 2,800-foot level considerable difficulty was encountered with "bad ground," starting at a point about 170 feet above the 2,800-foot station and continuing downward to a point approximately 200 feet below that station. This ground condition was caused by the shaft passing through a fault on about the 2,800-foot level. The ground was full of small gouge planes, and the blocks of quartzite broke along these planes and pressed against the shaft timbers. It was difficult to keep the shaft open and in alignment for the cages. The conditions were similar to those in the Morning shaft in the same district where concrete had failed. A section of the shaft in the heavy ground had been concreted, but the concrete failed and had to be removed. To relieve this condition sand has

been filled in back of the shaft timbers in three different sections: (1) Between the 2,800-foot station and 2,800-foot skip pocket, 89.5 feet "sanded" in March and April, 1929; (2) below the 2,800-foot skip pocket to a point about 20 feet above the bottom of the shaft, 88 feet sanded in January, February, and March, 1930; (3) immediately above the 2,800-foot station, 168 feet sanded in January, February, and March, 1930.

No trouble has been experienced in keeping the shaft in alignment since this work was done; the process saved the necessity of putting in jacket sets.

The Star main raise, immediately above the 2,500-foot level, passed through a crushed zone that threatened to give considerable trouble with the raise timbers. This section was sanded over a distance of 52 feet in March, 1929. The present condition of this portion is very favorable, and no complaint has been made of the timbers getting out of line.

STEEL SETS

Steel sets are favored in some districts, such as Pachuca, Hidalgo, Mexico, and the iron districts of the United States. The use of steel eliminates the fire hazard, and the steel lasts longer than timber. The cross section of a shaft can be less when steel sets are used as wall plates, and end plates and dividers can be narrower than wood for equal strength. On the other hand, steel is more expensive than timber. It is difficult to partition off the various compartments to prevent rocks from skips falling into the cage compartment. Generally steel sets have not proved satisfactory in moving or in very heavy ground. A $\frac{1}{4}$ -inch compression at one end causes a wall plate to bow in nearly 4 inches in a 5-foot compartment. In extremely wet shafts or where the water is acid steel sets may fail from corrosion long before timber sets would decay.

Placing steel sets.—Steel sets are usually kept about 30 feet from the bottom of the shaft when sinking is being done. A rough timber staging hung from the bottom set by chains about 7 feet long provides a platform upon which the men work to install the sets, protects the men in the bottom from falling objects, and protects the shaft sets and pumps from damage from blasting. One-half of the staging can be dropped down against the side of the shaft to provide an opening for the sinking bucket. In installing the shaft sets the individual members are lowered to the shaft bottom in their respective positions. The corner angle-iron studdles, which correspond in position to the posts in a timbered shaft, are first bolted in place, the end plates raised and attached to the corner studdles, and place, the end plates raised and connected to the end plates. The dividers, subdividers, and center studdles are next bolted loosely. The set is then plumbed, squared by blocking and wedging at the corners and at the ends of the dividers, and all bolts are tightened. If lagging is used it is next put in place.

Figure 35 shows the details of a steel shaft set.³⁶ The studdles must be cut accurately at right angles so the ends will bear on the wall plates. They are cut with a cold saw running in oil. All rivets

³⁶ Information furnished by Eugene H. Heald, division contracting manager, American Bridge Co., Chicago, Ill.

are three-fourths inch in diameter. The rivet holes are thirteen-sixteenths inch except in studdles and studdle connections, where they are fifteen-sixteenths inch. Nut locks are used on all bolts. Details of typical precast concrete lagging or lath to be used with these steel sets are also shown in Figure 35.

Slabs of six different shapes are used in lagging regular sets, comprising a total of 67 pieces per set. A few pieces of the design marked as slab B (see fig. 35), which are 2½ inches shorter than slab A, are inserted in each panel of lagging. These are the "key" pieces and are held in place by blocking at the top and bottom. The

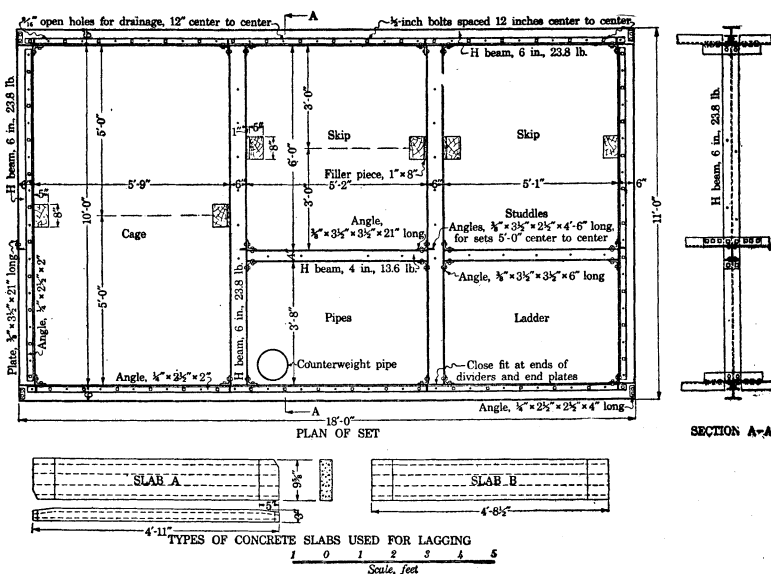

FIGURE 35.—Steel shaft set

majority of slabs have beveled corners (see slab A) so that they can be inserted between the flanges of the H beams, which form the main horizontal members of the steel sets, by tipping them sideways. Bearers, consisting of steel I beams, are placed directly under the end plates and dividers of the sets at the desired intervals. At such places a half dozen special forms of concrete slabs are used to fit around the projecting ends of the bearers.

Gogebic iron range practice.—According to Foss: ³⁷

The use of steel for shaft sets has been a standard practice on the Gogebic iron range, in Michigan, for many years. In fact, the only shafts sunk in the last 20 years in which wooden sets were used have been small prospect shafts. During this period about 12 large operating shafts have been sunk to depths of approximately 2,000 feet, all of which have been lined with steel sets. In recent years the tendency has been to eliminate the use of wood almost entirely, so as to make the shafts fireproof and to reduce the cost of upkeep to a minimum.

The following is a description of a large steel and concrete lined shaft, sunk by the Castle Mining Co. at Ramsay, Mich., which is representative of the present standard method of shaft construction in this district. This shaft was

³⁷ Foss, A. L., *Steel Shaft Sets on the Gogebic Iron Range*: Eng. and Min. Jour., vol. 126, Sept. 29, 1928, p. 497.

started in 1923 and was completed two years later to a depth of 2,207 feet. The outside dimensions of the shaft sets are 12 feet 6 inches by 19 feet 8 inches. The shaft is vertical and has 6 compartments, 2 skip roads, 2 cage roads, a ladder road, and a pipeway. In this shaft the sets are constructed of 6-inch H beams which weigh 23.8 pounds per foot and are installed at 6-foot centers. Studdles used are of 2½ by 3½ by ½ inch angle iron, 12 of these being used on each set of steel. The end plates are attached to the wall plates by a vertical 3 by 3 by ½ by 21 inch angle iron on the inside corner. One leg of the angle is bolted to the end plate and the other leg riveted to the wall plate. The angle iron at the corners protrudes 7½ inches above and below the H beam, and to these ends the studdles are bolted. The angles thus serve two purposes. Attachment of a divider to the wall plate is accomplished similarly, except that there is an angle on each side of the divider, one of which is 6 inches long and the other 21 inches in length, the latter serving to attach studdles. At the junction of two dividers three 6 by 3 by 3 inch angles are used in the corners and one 21-inch angle, the latter also serving to attach studdles.

As this shaft was intended to be fireproof, the only wood used was for the guides and temporary blocking while installing sets. Reinforced-concrete lath or lagging was used for the entire length of the shaft. The lath were made the shape of a plank, 2½ inches by 8½ inches by 5 feet 11 inches, 90 pieces of these being required to lag up a set of steel. Instead of being installed outside the H beams, the lath were installed between the flanges with the butts against the web. To hold the lath against the outside flange of the H beam, it was necessary to attach a small angle to the web of the H beam for this purpose. Key lath, 2½ inches shorter than the others, were required in the center of the wall plates and end plates in order to lath the sides in tight. The lower ends of the key lath rest on a short block. The concrete lath are reinforced by six ¼-inch iron rods, laid lengthways. Between main levels in the shaft the ladder road is boxed in with reinforced concrete lath which are ½ inch thick. Three ¼-inch rods are used for reinforcement in these lath.

Shaft sets are blocked and lined in by means of short wooden blocks and wedges. After the shaft set is thus blocked, cement sacks filled with a wet concrete mix are placed between the steel and the wall rock at various points around the perimeter of the shaft. This constitutes the permanent blocking, and the wooden blocks are allowed to remain as long as they may.

Bearing pieces, installed at irregular intervals whenever needed, consisted of heavy I beams laid parallel to the end plates, and were firmly hitched and concreted in the wall rock.

All attachments of angles to the wall plates and dividers which it was not necessary to make during installation were riveted at the factory. This simplified the work of installation and possessed the additional advantage that it required no additional work at the mine shop.

Pachuca practice.—Steel shaft sets or steel stulls have proved very satisfactory under the conditions existing at Pachuca. At the Cia. Real del Monte y Pachuca the country rock is solid andesite. The walls of vertical shafts in this rock stand perfectly, without support or lagging except where the shafts cut through veins or fault gouges or where sections of a shaft are affected by the subsidence caused by extraction of ore in neighboring veins. Steel sets and steel stulls or dividers are used in vertical shafts in solid ground in this district. Timber sets are used in vertical shafts in heavy ground and in inclined shafts. Timber stulls or dividers are also used both in vertical and inclined shafts. The 16 principal vertical shafts of this company, having a combined depth of 7,600 meters (24,600 feet), are timbered as follows:

| | Meters | Feet |
|--------------------------------|--------|--------|
| Steel sets..... | 2,300 | 7,550 |
| Steel sets or dividers..... | 2,900 | 9,515 |
| Timbering sets..... | 1,700 | 5,575 |
| Timber stulls or dividers..... | 600 | 1,970 |
| | <hr/> | <hr/> |
| | 7,500 | 24,610 |

The three principal inclined shafts are timbered entirely with wood. Their total combined depth is 1,450 meters (4,760 feet), of which 1,100 meters (3,610 feet) are timbered with sets and 350 meters (1,150 feet) with stulls.

Some of the important shafts or portions of them are very old; sections of these shafts near the surface and in heavy ground have been lined with masonry. A number of the shafts have been lined with concrete from the surface down to solid rock. Steel construction is used in the district only in solid ground and is not designed for supporting heavy ground. The Santa Ursula shaft was at one time timbered largely with steel. Movement of ground due to the mining of veins through which the shaft passes developed excessive weight, which the steel sets could not withstand. After the failure

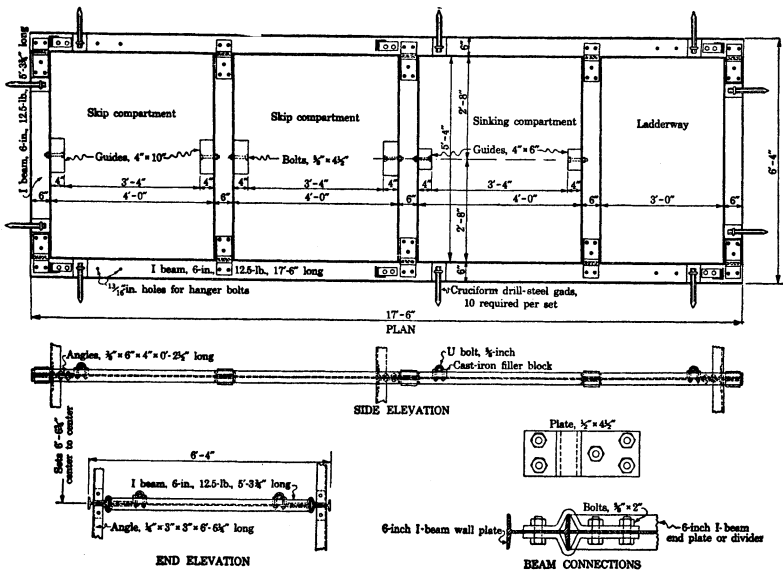

FIGURE 36.—Steel shaft set, Interior shaft, Santa Marghrita mine, Cia. Real del Monte y Pachuca

of the steel about 100 meters (328 feet) of the worst part of the shaft were lined with reinforced concrete approximately one-half meter (20 inches) thick with steel dividers. The concrete also soon failed; it could not be repaired and was difficult to remove so the use of both steel and concrete was abandoned and the shaft relined with Oregon fir. Timber sets need constant repair, but they can be repaired easily while the shaft is in operation.

A steel shaft set representative of Pachuca practice is shown in Figure 36. The principal difference between this set and the one shown previously is in the use of I beams instead of H beams and in the method of making connections. The steel sets are anchored against horizontal movement by scrap drill steel fastened to the sets by cast-iron filler blocks and bolts. The points of the drill steel are driven against the rock. Bearer sets are used at intervals of 24 meters (78.3 feet); these consist of steel beams across the shaft under the dividers and end beams. The bearers are hitched into the solid

rock and set in concrete. The sets immediately above the bearers rest upon them, and the sets below are suspended from them.

Installing steel sets at Pachuca is usually done from platforms suspended from the last set in place, the members of the next set being lowered by the sinking hoist. No work is carried on at the bottom of the shaft while the sets are being installed.

In the Pachuca district lagging is seldom used in conjunction with steel sets except immediately below and above a station. Lagging could be used to prevent sloughing of the ground provided excessive weight is not developed.

Many of the shafts at the Cia. Real del Monte y Pachuca have steel dividers and stulls in place of steel sets to support the guides, ladders, landings, etc.; this construction has been just as satisfactory as steel sets. It does not, of course, provide for any lagging, but in the few instances in which lagging is needed I beams or rails can be used to act as wall plates and to support lagging. The wall plates of steel are fastened to the steel stulls or dividers by U bolts or through-bolts or by welding. The stulls or dividers are set in shallow hitches in the rock, and the hitches are afterwards filled with concrete. This construction is first class, serviceable, and dependable. It costs less than steel sets, but often requires longer time for installation because of the hitch cutting, which is rather tedious. In the shafts where a masonry lining was used hitches can easily be cut in the masonry and steel dividers used; as these old shafts usually have a rather small cross section timber dividers of sufficient strength or steel sets are impracticable.

Where steel dividers are substituted for steel sets either I beams or T rails from the scrap pile are used.

No attempt is made to paint or otherwise preserve steel dividers and sets; such precautions are evidently unnecessary at this property, as steel dividers that have been in some of the shafts at least 20 years have shown no appreciable corrosion.

The primary reason for the use of steel sets or dividers is to give a fireproof and permanent construction. Steel ladders, the sides of which are made of 2 by 2 inch angles and the rungs of $\frac{3}{4}$ -inch round iron, are used in the shafts with both forms of timbering. The landings are made of reinforced concrete slabs, designed to rest snugly on the steel I beams and grouted in place. The landings are three sets or approximately 20 feet apart.

The main objection to the use of steel sets or dividers in shafts of great depth is that in case of ground movement they can not be replaced with timber sets because of lack of space. If loose ground is encountered it is impossible with this class of construction to put in heavy reinforcing timbers between the hoisting and manway compartments to support the ground. Steel dividers must be used between the compartments. These are not entirely satisfactory, as they are inclined to bend, and in making repairs they must be cut with a torch. A better steel construction, but one that so far has not been used in the Pachuca district, would be to put in double dividers of steel either as stulls or as dividers in the steel sets between each compartment. These double dividers should be so placed that they would give at least 12 inches available width between the guides;

then if timber was necessary in any section of the shaft this 12-inch spacing would allow a regular 12 by 12 inch divider to be used.

In solid rock where shafts do not require lagging steel sets cost about 30 per cent more than timber sets. In the La Rica shaft, which measures 19 feet 3 inches by 6 feet 4 inches outside of the sets, the total cost for the steel timbering, including concrete manway landings and screen partitions between counterweight and manway compartments but not including ladders, was \$68.07 United States currency per meter, or \$20.74 per foot of shaft.

In other shafts the cost of steel sets, which were purchased fabricated in the United States, was \$67.04 per set delivered in Pachuca. This included all the steelwork, bolts, U bolts, and rods, but not castings. The weight of the steel was 1,362 pounds per set. As the sets were placed on 2-meter (6.56 feet) centers this made a charge of \$33.52 per meter, or \$10.22 per foot, for the steel.

GUNITING

Some ground is firm when freshly broken but swells and sloughs on exposure to air and moisture. Guniting the ground before this action starts often prevents swelling.

The rhyolite through which the Goldfield Deep Mines shaft was sunk stood very well when dry. After water was encountered in sinking the shaft and bailing was started the water slopping from the bucket wet the walls, which immediately began to swell. Progress in the shaft was delayed, as the entire time of the crew was taken for repair work. Wire mesh was then nailed to the timber and lagging and covered with a 1-inch layer of gunite. The trouble from swelling ground then ceased. Guniting for fire protection is also practiced extensively; however, no open spaces that can act as flues should be allowed behind the timber.

At the Magma mine the timber in shafts and stations was found to have decayed back of the gunite. A set may be entirely decayed without showing any outside evidence before failure. Therefore timber to be gunited should first be treated to prevent decay.

In 1924 the cost of guniting two compartments of the Magma No. 3 shaft from the surface to a depth of 1,600 feet, using metal lath, was as follows:

| | Cost per square foot |
|---------------|-------------------------|
| Labor..... | \$0.039 |
| Material..... | .055 |
| | .094 |

A total of 38,078 square feet was covered at a cost of \$3,579. The cost per foot of shaft was \$2.31. The shaft was not gunited below 1,600 feet. A fire⁸⁸ broke out in the shaft in 1927 at the 2,350-foot level. Although the lining in the gunited section of the shaft was partly destroyed by the fire and had to be replaced the walls did not cave as they did in the section below the gunite. In 1921 the cost of guniting a 3-compartment shaft in Butte was about \$7 per linear

⁸⁸ Gardner, E. D., and Parker, D. J., Shaft Fires—Magma Mine: Rept. of Investigations 2882, Bureau of Mines, 1928, 8 pp.

foot. The area gunited per foot of shaft was 54 square feet. A combination of concreting and guniting is shown in Figure 37.³⁹

The method of applying gunite has been described by George J. Young.⁴⁰

CONCRETE LININGS

The general method of lining shafts with concrete is to use solid concrete walls with dividers. Coal-mine practice has favored the use of buntons, whereas in metal mines the partitions between compartments are usually cast as an integral part of the shaft lining. Curtain walls impart added strength to rectangular shafts and permit thinner outside walls.

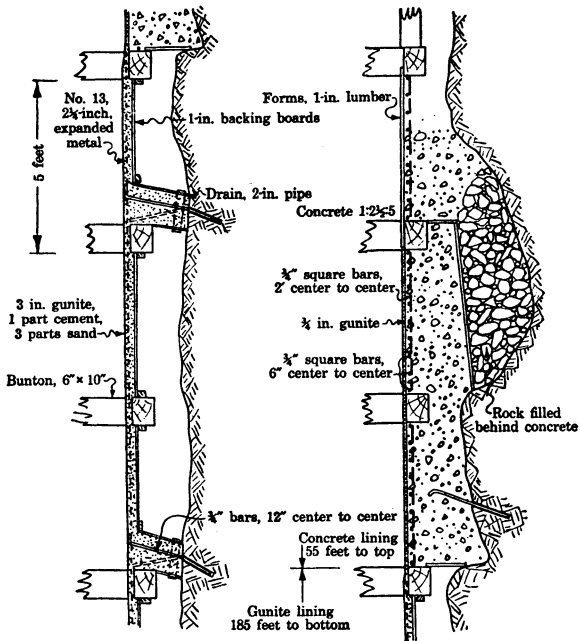

FIGURE 37.—Combination concrete and gunite shaft lining

Precast mine-shaft sets have been used as well as precast cribbing. An innovation of casting solid rings or sets in place has been adopted by the United Verde Copper Co. in ground that stands well.

Mixing concrete—Composition.—The Portland Cement Association recommends:⁴¹ (1) That concrete for shaft linings be mixed for $1\frac{1}{2}$ minutes in a standard revolving-drum type of mixer and (2) that it contain not more than $6\frac{1}{2}$ gallons of water per sack of cement, including the moisture in the aggregate.

The report of the subcommittee of the national standardization committee of the American Mining Congress⁴² on use of concrete

³⁹ Gillespie, R. H., Lining a Shaft with Concrete and Gunite without Interfering with Operations: *Coal Age*, vol. 20, Aug. 25, 1921, p. 287.

⁴⁰ Young, George J., Application of Cement Mixtures by Machinery: *Eng. and Min. Jour.*, vol. 111, Nov. 26, 1921, p. 537.

⁴¹ The Portland Cement Association, *Concrete in Coal-Mining Structures*: New York, 1929, 62 pp.

⁴² Allford, N. G., Concrete Shaft Linings at Pennsylvania Bituminous-Coal Mines: *Min. Cong. Jour.*, January, 1927, p. 61.

in mine timbering gives the mix (the proportion of cement to sand to gravel) for concrete linings at 23 coal-mine shafts as follows: 18 shafts, 1:2:4; 2 shafts, 1:2½:4; 3 shafts, 1:2½:5.

Mixes of 1:2:4, 1:2:5, or 1:3:5 are used at western metal mines and have proved satisfactory. For thin walls the junior author has used a 1:2:3 mix. Calcium hydrate can be added to make the mass flow more readily when tamped. Enough, and only enough, water is generally used in mixing so that the concrete will run readily in the delivery pipe and distributing spout. The delivery spout should be at an inclination of 25 or 30°. To obtain the best results clean and chemically inert sand and gravel or crushed rock should be used. The purest available water should be used and should contain no harmful salts. For important work the water and aggregate should be sent to a testing laboratory to ascertain their qualities before being used.

Washed sand is used for most shaft jobs. Stream gravel, when available, either alone or mixed with crushed rock, appears to be favored for coarse aggregate. Crushed limestone is satisfactory for most shafts, but where acid mine water may come in contact with the concrete some material other than limestone should be used. Iron blast-furnace slag has proved satisfactory for aggregates at Woodward, Ala. Coarse aggregate that will pass a 3-inch grizzly has been used, although the general practice is to use screened aggregate not more than 1 inch in size. This is the maximum size that can be satisfactorily dropped through delivery pipes. The minimum size is generally from ⅜ to ¾ inch. The Magma Copper Co. used stream gravel that contained the right proportion of sand for the mix used at that mine (1:3:5).

In concreting the Chief Consolidated working shaft the water and aggregate were heated before being mixed to shorten the time of setting of the concrete.

Mixing plant.—The mixing plant consisting of material bins, measuring devices, and a standard revolving mixer is placed either at the collar of the shaft or at a station above the section to be concreted.

The plant used at the Campbell shaft of the Calumet and Arizona Mining Co. is an example of an efficient surface installation. The sand and gravel were dumped from trucks into bins with chute gates at the bottom. The cement was emptied into a third bin leading into a 4-inch pipe. The gravel, sand, and cement were drawn separately into a side-dump car with three compartments; each compartment held just the right proportion of each ingredient for a charge of the ⅓-cubic-yard mixer. The mixed charge was dumped into a hopper, from which the concrete ran down a 4-inch pipe in the shaft to the forms.

Installations at stations generally can not be so conveniently placed because of lack of headroom. The material for the concrete is usually lowered in cars and run off the cages at a temporary landing at the top of the station and dumped into bins. It generally has to be shoveled by hand into the mixer.

Solid walls.—Generally only inside forms are used in lining the shaft, and the space behind them to solid rock is completely filled with concrete. Therefore, in sinking, shafts are kept as nearly to section as possible. At the United Verde the contract miners are

penalized 10 cents per cubic foot for all overbreak. In soft or sloughing ground where overbreak is excessive back forms may be used and the space behind filled with broken rock. An uncommon use of back forms is illustrated at the Chief Consolidated shaft, described later.

The method of placing a wall varies. The shaft may be concreted after being sunk, beginning either at stations or from the bottom, or sections of various lengths may be concreted as sinking progresses. The junior author has sunk and concreted shafts where at times only a 10-foot section could be sunk before it was necessary to concrete to within 5 feet of the bottom. Wherever avoidable, however, concreting should not be done within 100 feet of the bottom. Although no apparent damage may be done experience indicates that blasting has a detrimental effect on green concrete.

Delivery of concrete to forms.—The concrete may be either lowered in buckets or cars or dropped through pipes. When a sinking bucket is used the concrete is dumped into a movable hopper above the forms, whence it flows into the forms through a launder or chute. When cages are used the concrete is usually lowered in a hopper-bottom car with a gate at the bottom. The concrete is allowed to run into a funnel-shaped pipe through a hole in the bottom of the cage and thence through a flexible telescoping pipe or through chutes to the forms. Dropping the concrete through a pipe is more economical and is the method generally employed in lining deep shafts. Some operators, however, consider that with adequate hoisting facilities concrete can be as cheaply delivered to the forms by buckets as through a pipe to a depth of 250 feet.

Concrete can be delivered to the forms through 4-inch pipe as fast as it is mixed. No trouble is experienced by the pipe clogging where all oversize in the aggregate is screened out. Elbows can not be used as the falling concrete rapidly cuts them out. A length of 5-inch pipe, telescoped over the 4-inch main pipe, is ordinarily used at the ends of the lines so that the main line need not be shortened or lengthened after each ring is poured. At some mines provision is made at intervals of about 300 feet to break the fall of the charge in the pipe, but this is not necessary. At others concrete is dropped 3,000 feet through straight pipes with satisfactory results. At the Magma Copper Co. mine the speed of dropping is reduced by a piece of rubber belting placed over the top of the pipe immediately after the charge is emptied into it. A partial vacuum is thus formed which retards the falling of the charge through the pipe. Coal-mine practice has been to deliver the concrete from the bottom of the pipe to the periphery of the shaft through a flexible pipe or through wooden chutes. At western metal mines the concrete is usually discharged into an ordinary sinking bucket with a lip or spout riveted to the brim. The concrete runs into the forms through a corrugated-iron launder attached to the spout. The bucket is suspended either from the hoisting cable or by about a 50-foot length of cable attached to the timber above and can be revolved to place the concrete at any desired point in the shaft. The bucket may have a false bottom to facilitate cleaning. The concrete remaining in it after each run is removed by shovels and placed in the forms before it has an opportunity to harden. The use of a bucket corrects the results of any segregation which may take place in falling down a long pipe.

Packing.—The charge must be properly placed to prevent segregation of aggregates and consequent weakening of the structure. In relatively thin walls special care must be taken in placing the concrete. The Portland Cement Association recommends that during placement concrete should be thoroughly spaded in layers not more than 12 inches thick to remove impounded air and water. The association also recommends that the scum which rises to the top of the concrete as each ring is laid should be carefully scraped off before more material is added. If water-tight connections are desired several inches of concrete at the end of each stopping point should be removed just after the concrete has stiffened and before it becomes too hard. The surface at a stopping point should be cleaned with a stiff brush without the use of water to remove all loose particles of aggregate before more concrete is added.

Curing.—Improper conditioning of the concrete is the most frequent cause of failure in shaft walls. The quantity of water used for wetting the concrete and the period during which it must be kept wet depend, of course, upon the condition of the air in the shaft. In an upcast ventilation shaft where the atmosphere is saturated no wetting will be necessary. In a downcast shaft the surface of the concrete should be kept wet from 7 to 10 days. The newly laid concrete should be protected from running water to prevent washing out the cement; sheet-iron-back forms are generally used for this purpose.

Forms.—Two general types of forms are used—built in and removable. When the first type is used the forms are built as the concreting progresses. After the forms are stripped some of the lumber may be reused. Three or more sets of movable forms are required for concreting a shaft.

In rectangular shafts with compartments interior bracing of the forms other than that for forming the dividers or curtain walls is not necessary. However, where a large section is concreted as one compartment interior bracing is required.

Concreting at the Magma Copper Co. mine illustrates the use of built-in forms. The forms are made of ordinary 2 by 10 inch mine lagging placed vertically. The lagging is held in place by 4 by 6 inch framed timber placed at 5-foot intervals and corresponding to the distance between the shaft sets, which are removed one at a time as concreting progresses upward. No back forms are used. A section between two levels is concreted and allowed to set, after which the forms are stripped. The lagging is then used for ordinary mining purposes and the 4 by 6 inch timber reused in concreting. Matched timber was used for the first part of the shaft, but the results obtained were no more satisfactory than when the less expensive lagging was used.

Movable wooden forms have advantages over those made of steel in that they are cheaper, lighter, and easier to handle. They may be moved by hand, whereas the steel ones must be handled by block and tackle, by the sinking hoist, or by both. The advantages of the steel form lie in its rigidity and freedom from breaking and in making a smoother lining. Steel forms appear to be favored for circular shafts and wooden forms for rectangular shafts. The lumber in wooden forms warps between jobs and must be replaced before the forms can be reused. Moreover, wooden forms must be

kept wet for proper conditioning of the concrete, whereas the steel forms are air-tight and retain the moisture.

Figure 38 shows wooden forms used by the Calumet and Arizona Mining Co. for concreting a 3-compartment shaft. The set of forms (12 pieces) shown costs about \$1,000, and three complete sets are needed for continuous progress; otherwise the workmen would have to wait for the concrete to harden. Considerable machining is necessary in fitting the steel or iron parts. In building movable wooden forms the lumber should be soaked before fitting to prevent the effects of subsequent swelling.

Figure 39 shows the forms used in the Campbell shaft of the Calumet and Arizona Mining Co. The forms are each 6 feet 8 inches long, three equaling the length of a 20-foot guide. The separate parts of the forms used for each compartment are hinged together

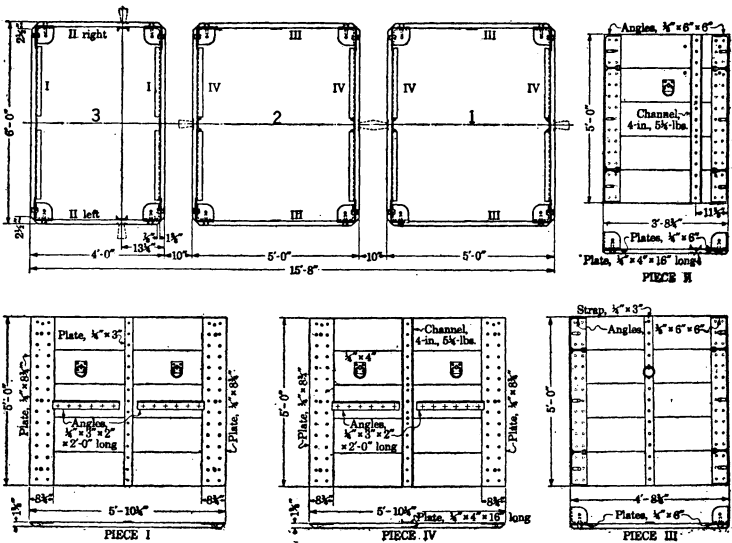

FIGURE 38.—Wooden forms for concreting shaft, used at Calumet and Arizona mine

at the corners. They are made of $\frac{1}{4}$ -inch plate, and each section is strengthened by vertical angle irons at the edges and by horizontal 3 by 3 by $\frac{5}{16}$ inch angles at the top, bottom, and two intermediate positions. In addition, at both top and bottom edges heavy angles of the same size are used to support the ring sections, one on top of the other.

The Campbell shaft is oval and has two skip compartments, each 5 feet by 4 feet $7\frac{1}{2}$ inches, and a large service compartment, 10 feet 8 inches by 5 feet 3 inches. An 8-inch concrete partition separates the skip compartments from each other and from the cage compartment. The curved ends of the shaft provide extra area for ventilation and probably increase the structural stability of the shaft.

The forms for the cage compartment are in two parts bolted together at the apex of the curved section and at the guide on the opposite side of the compartment. The forms for the skip compartments are also in two parts divided by the guides on either side.

To remove the forms they are unbolted and pulled from the wall by means of a turnbuckle. They are then raised in the clear by means of chain blocks, placed on the crosshead platform, and hoisted approximately to the next position. They are lowered into place by means of the chain blocks.

In concreting a section of shaft, the bottom of the first form is placed 18 inches above the junction between guides. The guides are lined in position on the shaft timbers before concreting and are left in place.

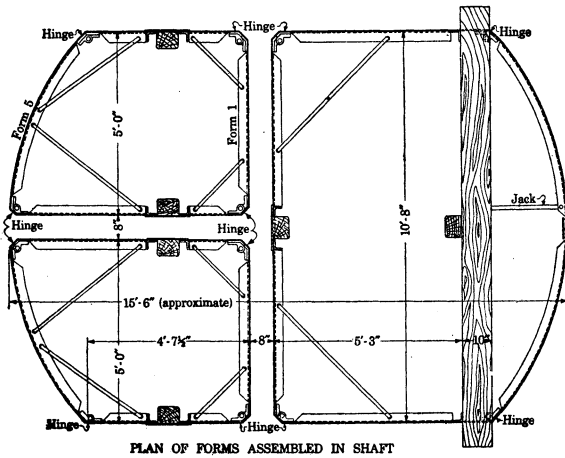
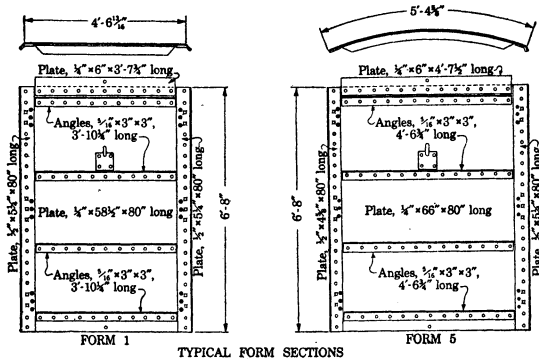

FIGURE 39.—Steel forms with rounded ends for concreting Campbell shaft

In the skip compartments the forms are braced and held in position at the corners by bars; the bent ends of these are placed in holes in the top of the angle reinforcement. As the bars are of fixed length, the contiguous parts of the form are placed in exact position. The cage compartment is similarly arranged. A special jack is used as a brace for the curved segment of the large compartment.

The forms are carefully made and are as rigid as possible. The joints are made tight by milling adjacent segments. Rivets are countersunk on the face next to the concrete. Rings are provided for handling. Three complete sets of the steel forms shown in Figure 39 cost \$5,000 to \$10,000.

Steel forms used by the Oliver Mining Co.⁴³ in a rectangular shaft were of small paneled sections easily handled by ropes and block and were made of $\frac{3}{16}$ -inch plate stiffened at the edges by $2\frac{1}{2}$ by $2\frac{1}{2}$ by $\frac{3}{16}$ inch angles. The panels ranged in size from $6\frac{1}{2}$ by 12 inches to 2 feet 11 inches by 5 feet $11\frac{1}{2}$ inches. In all, 46 panels were required for one complete 6-foot set and 32 for one 4-foot set. The panels were bolted together to make the form. Six panels were used in an end, eight for a wall plate, and nine small filling panels between the end pieces and dividers. Keys of $\frac{1}{2}$ by 4 inch flat steel were used between the panels to facilitate removal of the forms. Braces of 2-inch pipe and spacers of 3 by 6 plank were used within the forms to keep them in alignment. Six sets of forms were used, making a section of 24 feet of lining in bad ground or 36 feet in uniform rock. Precast concrete dividers and end pieces reinforced with steel rods and of sufficient length to be well imbedded in the lining were placed at intervals. The reinforcement extended beyond the end of the cast pieces. These precast pieces supported the forms. Alignment was obtained by bolting the forms to the end pieces through holes left for the purpose.

Aligning forms.—The same general method of aligning forms is used as in aligning shaft sets. Three plumb lines of piano wire are usually dropped in the shaft, two at the corners in one end and one in one corner at the other. In lining shafts through which considerable air passes difficulty is experienced in keeping the plumb lines from vibrating. At the Campbell shaft the fans were shut down and the plumb lines hung. After becoming stationary the wires were fastened in place at about 100 feet above the section being concreted by wedging them as they hung free in slots in the ends of strips of sheet iron nailed to a shaft set. The fans were then started up, and no more trouble was experienced with vibration. At the Magma Copper Co. the plumb lines are secured above and below each section being concreted. Otherwise, an accidental touch during the process of checking the alignment of the forms starts the plumb bob swinging, and time is lost in steadying it.

Thickness of walls.—The thickness of concrete shaft walls depends mainly on the rock conditions. At the shafts considered in this paper the minimum thickness is $4\frac{1}{2}$ inches and the average about 12 inches.

According to the report of the national standardization committees of the American Mining Congress⁴⁴ on the use of concrete in mine timbering, the thickness of shaft walls at a number of coal mines is as shown in the following tabulation.

| State | Number of shafts reported | Maximum thickness, inches | Minimum thickness, inches |
|-------------------|---------------------------|---------------------------|---------------------------|
| Illinois..... | 35 | 36 | 8 |
| Wyoming..... | 5 | 24 | 12 |
| Pennsylvania..... | 6 | 30 | 12 |
| New Mexico..... | 1 | 16 | 12 |

⁴³ Engineering and Contracting, Method of Lining Shafts with Concrete: Mar. 19, 1919, p. 1259.

⁴⁴ See footnote 43.

The thickness of the shaft walls at representative metal mines is given later in the description of specific installations.

Reinforcing.—Reinforcement in concrete shaft walls tends to prevent spalling and gives additional strength where the concrete may be subjected to bending or put under tensile stress. The reinforcement is usually placed near the inside of the walls where the tensile stress is most likely to develop. In rectangular shafts the partitions or curtain walls usually fail first. In ground where heavy pressures

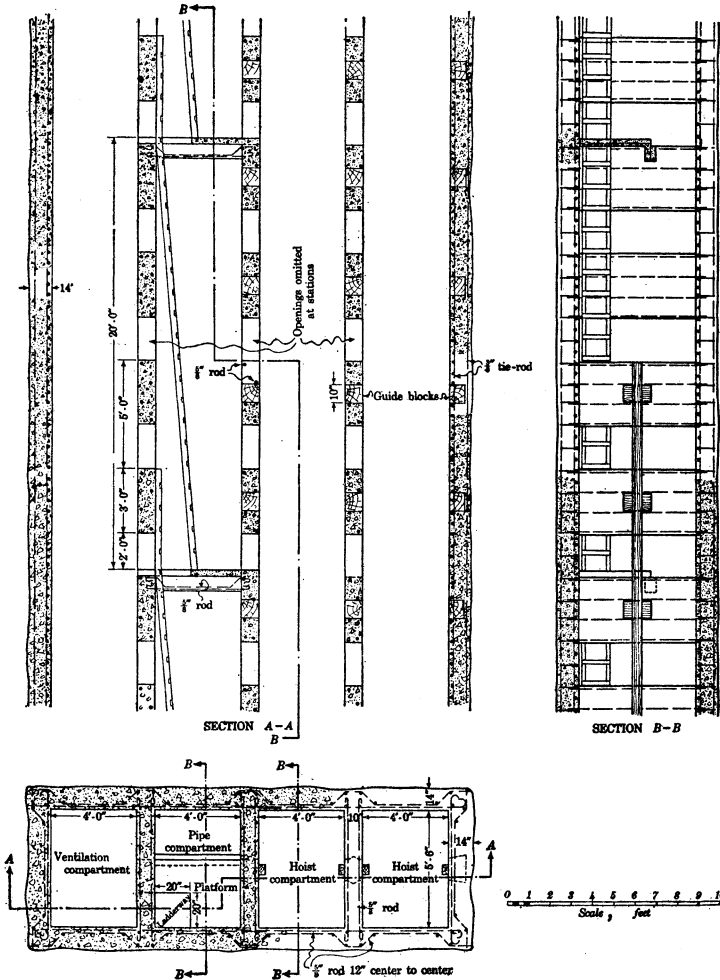

FIGURE 40.—General shaft plans and standard reinforcement, Magma Copper Co.

are expected the curtain walls are reinforced with I beams or T rails, the ends of which are either upset or placed against iron plates in the side walls. Ordinary reinforcing steel bars are $\frac{3}{8}$ to $1\frac{1}{2}$ inches in diameter and may be placed 6 inches to 1 foot apart. Old rails and other scrap iron are frequently used as reinforcement. Figure 40 shows the method of placing the reinforcement in the No. 2 shaft of

the Magma Copper Co. The reinforcing iron may be fabricated into mats on the surface before being lowered into the shaft. Reinforcement in a coal-mine shaft in New Mexico consisted of $\frac{3}{8}$ -inch rods placed 12 inches apart. Reinforcement was used in 18 of 27 coal-mine shafts listed in the foregoing tabulation.

About half of the concrete linings of metal-mine shafts are reinforced. Metal-mine shafts are reinforced less often than coal-mine shafts mainly because of the added strength imparted by casting curtain walls as an integral part of the lining.

Methods of placing concrete.—The United Verde No. 6 shaft was raised in full size and left full of broken rock. In concreting, the broken rock was drawn down 50 feet or until bad ground was encountered; sills were then laid and forms, supported by square-sets, placed. The concrete was next poured in through a 4-inch wrought-iron pipe from a mixer on the main level above. On completion of a 50-foot section the operation was repeated.

In the United Verde No. 5 shaft concreting was begun at each station and progressed upward. The section from the 1,950-foot to the 800-foot levels was raised but was not timbered. Steel forms 5 feet high, made up of $\frac{3}{8}$ -inch plate backed with $2\frac{1}{2}$ by 2 by $\frac{5}{8}$ inch angle iron and split at the middle line of the shaft, were used. The second section, from the 1,950 to the 2,550 foot levels, was sunk and timbered with 8 by 8 inch shaft sets. The timber was removed as concreting advanced; the forms were made of 1-inch sheathing on 3 by 3 inch studs.

The third section to the 3,150-foot level was timbered with special 8 by 10 inch shaft sets placed on 6-foot 8-inch centers with the outside of the face of the timber set to finished concrete lines. Panels of 2-inch plank backed by 3 by 3 by $\frac{3}{8}$ inch angles were set between the shaft timbers and held in place with angle irons spiked to the wall plates. Wooden boxes were placed above the wall plates where they passed through the curtain walls to permit reclaiming the shaft sets after concreting. The guide-bolt sockets were aligned with plumb lines, and a uniform vertical spacing was maintained by strap-iron spacers which remained in the concrete. This latter method of facing the shaft proved the most economical and quickest.⁴⁵ Twenty-one men, working on three shifts, were employed—18 shaft miners, 2 mixers, and 1 man at the receiver. The total cost per cubic yard of concrete placed was \$22.50.

The concrete was mixed in a 9-cubic-foot mixer in a permanent plant below the 500-foot level and delivered into a receiver through a 5-inch pipe in the manway compartment. The standard mix was 1 part cement, 3 parts sand, and 5 parts gravel. The cross section of the United Verde No. 5 shaft is shown in Figure 26.

The Campbell shaft of the Calumet and Arizona Mining Co. was concreted from the bottom station to the completed section above, using steel forms previously described. No reinforcement was used except at the guide-bolt receptacles, each of which had two short pieces of reinforcing steel. The minimum thickness of the wall was 6 inches, the maximum 3 feet, and the average about 18 inches, depending on the amount of overbreak. The concrete con-

⁴⁵ Mills, C. E., Shaft Practice and Hoisting Methods at the United Verde: Min. Cong. Jour., vol. 16, April, 1930, p. 327.

sisted of 1 part cement, $2\frac{3}{4}$ parts sand, and $4\frac{1}{2}$ parts broken rock. Six to eight men per shift working on two 8-hour shifts each, separated by four hours, placed 13 feet 4 inches each 24 hours. Two men in each of the 4-hour periods placed braces and made ready for the regular crews.

Windows 20 feet apart on alternate sides of the guide of the cage compartment were left in the wall separating the cage and skip compartments. In addition, windows were left in the partition between the skip compartments on each alternate form. The windows are 30 inches wide and 42 inches high.

Platforms in the cage compartment were carried below the three forms on timber placed in sockets left in the side walls. In placing the concrete a second platform was constructed and supported upon the angles of the last form in place. The concrete was then tamped into place in the forms and the shaft stripped for the next form above. The crossheads used in shaft-construction sinking were small enough to pass through the forms.

Sockets were provided in the skip compartment for placing buntons for emergency use after the shaft is in operation. Sockets were also provided in the walls of the cage compartment for the 10 by 12 inch divider.

At each station a space was left in the concrete lining for bell boxes and for 6 by 12 inch timbers to which chain links for holding the cage at the station were attached. Iron castings were set in the walls back of these spacers to hold bolts for fastening the bell boxes and timbers.

The Alpha shaft of the Consolidated Coppermines, Kimberly, Nev., was concreted while hoisting was in progress. Enough ground was taken out around the shaft timbers to provide room in which the men could work.

An example of concreting without removal of the timbers is shown in the working shaft of the Chief Consolidated Mining Co., Eureka, Utah.⁴⁶ An unusually thin shaft lining of reinforced concrete with precast dividers was used. (Fig. 41.) The concrete was cast as a shell and was in contact with the shaft walls only for the necessary support. The first 1,600 feet of the shaft passes through a soft rhyolite porphyry which, when exposed to air and water, slacks and swells.

It was decided that an air-tight shaft with suitably arranged drainpipes would decrease the slacking; and if properly reinforced, the concrete would withstand any pressure that might develop. The shaft is divided into three compartments—two hoisting compart-

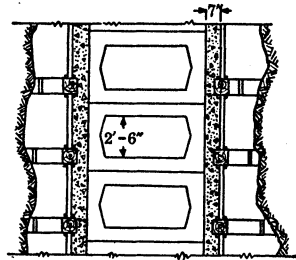

CONSTRUCTION USED
IN RHYOLITE

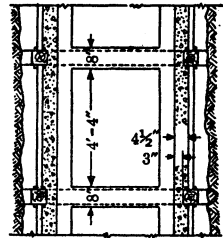

CONSTRUCTION USED
IN SOLID LIMESTONE

FIGURE 41.—Concrete lining,
Chief Consolidated shaft

⁴⁶ Parsons, Arthur B., *The New Concrete Shaft of the Chief Consolidated Mining Co.*: Min. and Sci. Press, vol. 122, Apr. 30, 1921, pp. 595-600.

ments, each 4 feet 4 inches by 4 feet 6 inches, and the third, 6 feet 1 inch by 4 feet 6 inches, for a "chippy cage," ladders, pipe lines, and cables. The procedure was as follows: The shaft was sunk and timbered for a distance of 35 to 75 feet, depending on the condition of the ground in the particular section and the strain being put upon the timbers. Concreting was started from a bulkhead 12 feet from the bottom and a connection made with the bottom of the previously completed concrete lining, the reinforcement interlocking to form a virtual monolith.

Timber sets of 6 by 6 inch material were placed on 2½-foot centers in porphyry and on 5-foot centers in the underlying limestone. Where pressures developed during sinking the lagging was removed and 6 or 8 inches of ground excavated. Reinforcing iron was placed, new lagging put in, and the area back of the lagging concreted from above. This procedure was followed frequently, as it was effective, did not interfere with operations at the bottom of the shaft, left the walls in such shape that rapid progress could be made when the concrete for the main lining was poured, and permitted sinking a longer section of shaft before concreting became necessary. This concrete became a part of the completed wall when the concrete for the regular walls was poured.

The regular concrete walls were 7 inches thick in the porphyry and 4½ inches thick in the limestone (fig. 41). The diagram shows the form of the timbering and the method of placing the concrete. The first 50 feet of the shaft was cast solid back of the timber line. Three bearers for supporting the vertical weight of the concrete were placed. A hitch was cut which entirely surrounded the shaft; it extended 3 feet into the rock and was about 30 inches high, with a square shoulder at the bottom and a 45° taper back to the regular excavation at the top. Precast concrete beams and reinforcing iron were placed, and concrete was poured to fill the hitch, thus making a heavy concrete collar.

The concrete lining was supported against the walls by 5-foot sections cast solid to the wall rock at 10 to 30 foot intervals. One 40-foot section in bad ground was concreted solid. Where additional strength was desired no open space was left in the precast dividers. In the solid limestone 6 by 8 inch precast struts were used instead of the heavy divider frames.

In concreting a section the temporary bulkhead was supported from the rock bottom by four posts in the corner of the shaft. The exact position of the inside corners of the lining was determined by plumbing from the concrete above. The precast concrete dividers were then put in position with the heavy lugs on the lower side wedged against the wall plates. The timber dividers of the shaft sets were purposely spaced so that they could remain until the concrete dividers were in place, after which they were removed. Eight mats of reinforcing steel were then hung in position and eight corresponding sectional forms for the inside walls placed. The mats were fabricated on the surface and held together by wire. They were carefully designed to assume the tensional strain and to hold the successive vertical sections together by means of interlocking one half inch round bars. The forms were made of 2-inch plank and were oiled on the inside. The corners were braced by triangular strips

made independent of the forms to facilitate stripping. The forms were held in place by 4 by 4 inch wooden braces, while the concrete spacer blocks insured the proper spread between the forms and the wall plates. No back forms were used for the first two or more courses; the concrete was thus allowed to extend to the walls and give solidity to the new section. The guides were set about one-half inch from the concrete, thin wooden shims being used to compensate for any slight irregularities of the wall. The average progress of concreting was 6.46 feet per day with a shaft crew of six men on each of three shifts. The concrete mixture was in the proportion of 1:2:4, although a richer mixture was used for special work. Selected sand and quartzite tailing from an old mill were used for aggregates.

Bearers.—In hard ground irregularities of the sides of the shaft prevent any settling of the concrete lining. In addition the concrete used at a station, which usually is an integral part of the shaft lining, serves as a bearer for the concrete in the shaft. In soft ground bearing sets are necessary. Steel beams are used for bearers in some districts. Bearers may be placed about every 500 feet, as at the Chief Consolidated, previously described; in soft ground a bearer may be necessary for each section concreted, as in the No. 2 shaft of the Detroit Rock Salt Co., described later.

Holders for pipe lines.—Pipe lines are held in vertical concreted shafts by clamps fastened to buntions in the shaft or attached to rods placed in holes drilled in the walls.

Water lines should not be cast in the concrete walls. At one mine in the Southwest where they were embedded holes rusted through the pipes after about 10 years, and the pipes could not be repaired or replaced because of their inaccessibility.

Back drainage.—Leakage of water through concrete shaft linings is undesirable; it can be prevented by the use of bleeder pipes, by back drainage, or by grouting. Bleeder pipes are set in the concrete as it is poured or put in holes drilled through the finished lining. To prevent the water pressure from building up behind green concrete or washing the cement from aggregate sheet-iron back forms are placed to collect the water which is then drawn through bleeder pipes. A survey of failures of concrete shaft linings in eastern mines showed that the principal cause was poor back drainage.

Where a large flow of water is encountered water rings may be excavated around the shaft section before the lining is placed. The water from the ring is (1) allowed to escape into the shaft through bleeder pipes in the concrete walls, (2) pumped to a level above or to the surface, as previously described, or (3) conducted through a pipe to the drainage system below. Rings are usually located just below water-bearing strata; they should be concreted and means provided for supporting the rock to prevent it from caving into the ring and reducing its capacity. A water ring should not be located at a closure joint of a concrete lining because of the possibility of leakage through the joint.

Figure 42 shows the method of placing water rings around a concreted shaft through water-bearing strata in a coal mine.⁴⁷

⁴⁷ Brosky, A. F., Lining a Shaft in Sixty-Foot Sections, Starting from Near the Top Downward, Gradually Reduces Cost: Coal Age, vol. 21, Apr. 6, 1922, p. 563.

A closure joint recommended by the Portland Cement Association, to be used at the end of each day's work, is shown in Figure 43, *A*. A joint for subsequent sections of shaft in ordinary rock is shown in Figure 43, *B*, and one for use in wet shafts is shown in Figure 43, *C*.

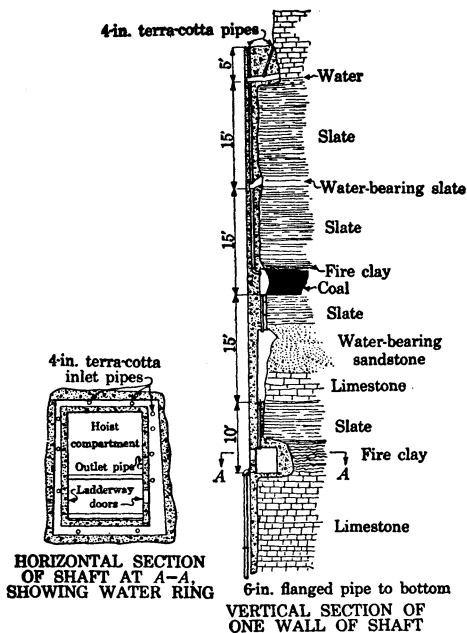

FIGURE 42.—Water rings in concreted coal-mine shaft

When a section of concrete lining was started at the Brier Hill shaft in Michigan a wooden curb was built around the shaft on which to seat the starting ring. Just above the curb wooden boxes

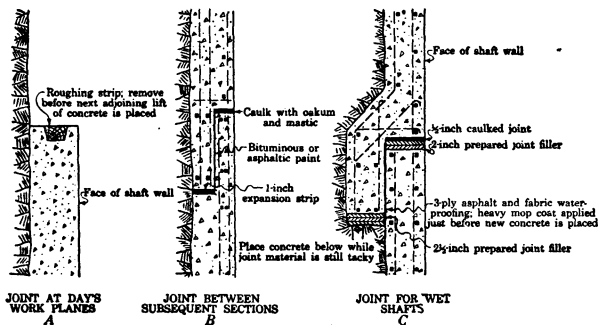

FIGURE 43.—Closure joints in concrete shaft

were inserted through the ring and across the lining space. These boxes left holes in the lining through which the closure joint from the next section below was concreted.

Concreting in combination with steel sets.—The Pyne shaft of the Woodward Iron Co., Woodward, Ala.,⁴⁸ was lined with steel sets and concrete. The shaft is rectangular in section, 13 feet 1 inch by 21 feet 1 inch outside measurements, and has 6 compartments—2 skip ways, 2 cage ways, 1 ladder way, and 1 pipe way. The steel sets were placed on 6-foot centers; 6-inch H beams weighing 23.5 pounds to the foot were employed for wall plates, end plates, and dividers,

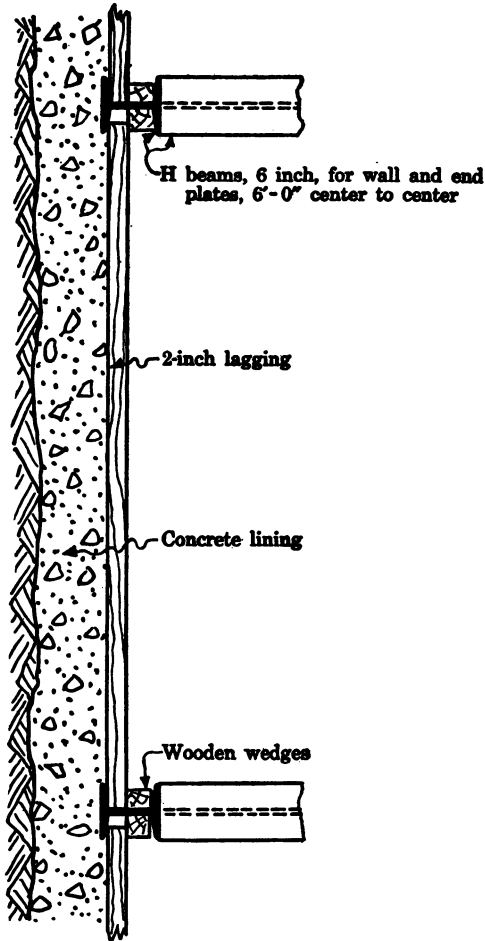

FIGURE 44.—Combination of concrete and steel sets for shaft lining

and 3 by 4 inch angles were employed to connect the sets. The different members of the sets were bolted together in the shaft. Twelve-inch I beams were used for bearers at about 100-foot intervals. The end plates and wall plates were set with the flanges in the vertical plane, and the shaft was lagged as shown in Figure 44. The lagging was used as the forms for lining the outside section of the

⁴⁸ Stovel, J. H., Sinking and Concreting Pyne and Songo Shafts: Eng. and Min. Jour. vol. 111, Apr. 23, 1921, p. 698.

shaft with concrete. No reinforcement other than the steel sets was used.

Ring method of concreting.—A ring method of concreting shafts has been devised at the United Verde Copper Co. for the No. 5 shaft below the 1,950-foot level. This consists essentially of casting the wall plates in place (fig. 45). Mills states:⁴⁹

The section of shaft below the 1,950-foot level was in good ground, requiring little support, and the concrete placed in 2½-foot rings at 6-foot centers. The chief difficulty in developing the ring method of concreting was the problem of hanging forms and sealing the forms to the irregular ground line. This was solved by suspending a sill frame of 4 by 10 inch material from the steel form

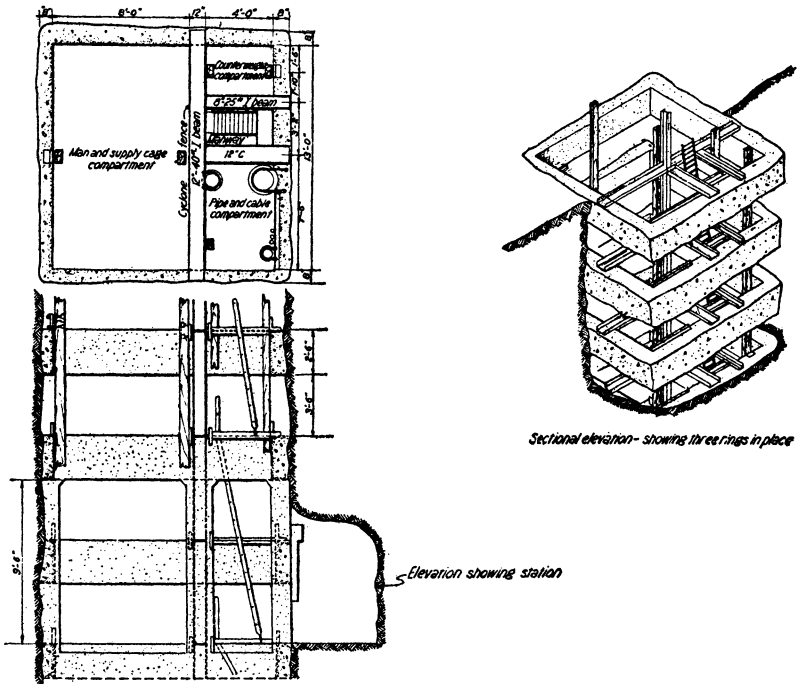

FIGURE 45.—Ring method of concreting shafts, United Verde Copper Co.

above by means of adjustable hanging rods with brackets to support the sills. The sills are leveled, lined, and sealed to the wall by 1-inch ship lap laid at right angles to the rock line and scribed to fit the irregular walls. If the walls are over 2 feet from the form, it is necessary to use additional bracing below the sheathing.

The reinforcing steel consists of six ¾-inch bars, with ⅝-inch vertical rods spot welded to make an easily handled unit. The reinforcing is next placed on the sills and overlapping corners wired together. The eight sections of steel forms are then lowered from the top or fifth ring above and held in place on the sill by pins. The corners fasten together with gusset plates and the centers are supported by angle braces. The ring is then checked for alignment, bolts set for steelwork by templates, and the ring poured.

As each ring is finished, the muck is drawn down, the walls trimmed, the cribbing stripped, and the cycle repeated. Eighteen men, working on three shifts, will pour a ring every day, except at stations which require special farm work. After each level is concreted, the steelwork and ladders are placed and the guides installed prior to removing the pentice.

⁴⁹ Mills, C. E., Shaft Practice and Hoisting Methods at the United Verde: Min. Cong. Jour., vol. 16, April, 1930, p. 330.

Data on raising the lower portion of the shaft are as follows:

| | | |
|---------------------------------------|------|-----|
| Average depth of hole | feet | 5 |
| Average number of holes | | 44 |
| Total footage drilled per round | feet | 220 |
| Average advance per round | do. | 4 |
| Average advance per shift | do. | 1½ |

The following tabulation shows the comparative cost between the ring and solid concrete method, also the detailed costs on the ring method per foot of shaft:

| Method | Feet | Excavation, per foot | Concrete, per foot | Total, per foot | Cost per cubic yard of concrete |
|------------------------|-------|-------------------------|-----------------------|--------------------|---------------------------------------|
| Solid, 1:3:5 mix | 1,550 | \$68.17 | \$146.84 | \$215.01 | \$58.80 |
| Ring, 1:2:4 mix | 450 | 77.11 | 50.11 | 127.22 | 61.30 |

Detailed cost per foot of shaft by ring method

| | Excavation | Concreting |
|---------------------|------------|------------|
| Labor | \$52.07 | \$16.60 |
| Shops | .26 | 5.90 |
| Supplies | 7.68 | 26.51 |
| Engineers | --- | 1.05 |
| Explosives | 8.47 | --- |
| Air | 2.08 | --- |
| Repairs | 6.55 | --- |
| Miscellaneous | --- | .05 |
| | 77.11 | 50.11 |

Precast concrete sets.—Precast concrete sets have been used at some mines. They are cheaper than solid concreting but are more difficult to install, inasmuch as after being put in position the sets must be concreted to the walls.

Precast concrete cribbing.—The use of this method of shaft support is illustrated by the installation at the American shaft of the South America Development Co., Zaruma, Ecuador.⁵⁰ The shaft contains two 50 by 60 inch compartments, except between the 7th and 9th levels, where it contains three. The compartments were enlarged 2 inches each way after being relined. Originally the shaft was timbered with sets of 7-inch native timber placed on 6-foot centers. Owing to the decay of the timbers the lining had to be replaced. It was necessary to keep the shaft in operation for hoisting two 8-hour shifts per day. The relining was done on the third shift; only five hours were available for the shaft work. Because of this condition precast concrete cribbing was employed. The crib members were 6 by 6 inches in cross section, reinforced with ½-inch deformed bars (fig. 46). The 2-compartment wall plates were cast in one piece and the 3-compartment members in two. The upper edge of each member in the hoisting compartment was protected with a 2-inch angle iron. The corners of the compartments were protected from falling rock with either wooden or concrete block bricking between the cribs. As the old timbers had rotted and the blocking had fallen away the old shaft sets were secured by scabbing

⁵⁰ Ganghart, Marcus D., Shaft Concreting at Zaruma, Ecuador: Eng. and Min. Jour., vol. 130, Sept. 25, 1930, p. 277.

sets and temporary blocking. These sets were suspended by old hoisting cables fastened in the rock about 90 feet above by eyebolts set in drill holes. The cables were looped around the timbers, and the slack was taken up with turnbuckles. After this preliminary work a concrete beam consisting of a solid ring of concrete was secured to the walls by old rails upset and hammered at one end to fit into drill holes. The bearers were 2 to 6 feet thick.

Six sets of concrete cribbing were then placed for each set of timber removed. The next set of timber above the cribbing was blocked to the concrete, the cables were moved up to the next one above, and the procedure was repeated.

The space behind the cribbing was back-filled with rock lowered in the cage as each set was replaced. The rock was in fragments that would not go through the 6-inch space between the cribbing. In bad ground the cribbing was blocked by concrete cast around steel cemented into holes drilled in the walls. In some instances

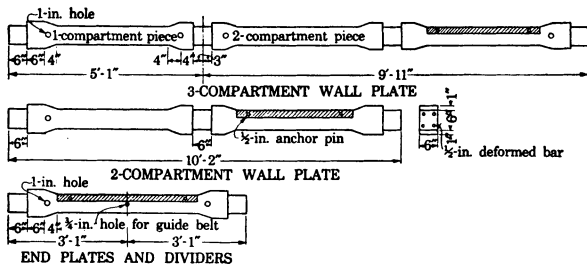

FIGURE 46.—Precast cribbing used at Zaruma, Ecuador

cement grouting was mixed with the back fill. The average progress was about 7 meters per month; when no time was lost, because of shaft repairs in other sections, the progress was 10 to 15 meters per month.

The shaft crew, in charge of a salaried employee, consisted of six to eight natives whose wages ranged from \$0.80 to \$2.00 per day.

The precast members and the bearers were made of concrete of a 1:2:4 mixture. The concrete for bearers was dropped through a 4-inch pipe from the station above. The materials for a complete 2-compartment set of cribbing cost \$15 and for a 3-compartment set, \$22. The average price of cement was \$2.85 per sack and steel reinforcement \$0.045 per pound. Total costs per foot including installation were: Labor, \$23.57; supplies, \$34.09; total, \$57.66.

GUIDES

Guides usually are installed on end plates and dividers. A single pair is used for skips and for cages in ordinary-size compartments; two pairs may be used in large-cage compartments. Guides generally consist of selected straight-grain timber; Oregon fir is preferred in the West, whereas hardwoods are used at some eastern mines.

As timber is more resistant to wear along the edge of the grain than flatwise the individual pieces should be selected to have the edge

of the grain on the side coming in contact with the shoes of the cage or skip. Guides usually are made of 4 by 6 inch timber dressed to $3\frac{1}{2}$ to $5\frac{1}{2}$ inches for 1-ton cages and for skips with capacities up to 4 or 5 tons. For larger installations the guides usually consist of either 6 by 8 inch timber dressed to $5\frac{1}{2}$ by 7 inches or 4 by 8 inch timber dressed to $3\frac{1}{2}$ by $7\frac{1}{2}$ inches. Ship or channel iron is used for guides in skip compartments at some metal mines. Railroad rails are sometimes employed as guides in coal mines. Eighty-pound rails 30 feet long are used at the New Orient coal mine. The rails are fastened together with splice plates ground to fit.

Iron guides cost more than wooden ones, but they last longer. Guides are cut to correspond to the distance between 3, 4, or 5 sets in timbered shafts and are 20 to 35 feet long in concreted shafts. They usually are fastened to the timber by lag screws or bolts through each end. The guides in the Teck-Hughes shaft are secured to the timber by angle plates (fig. 30). The guide practice at the United Verde Copper Co. is as follows:⁵¹

Guides as first installed in No. 5 ore hoisting shaft were 4 by 8 inches clear Oregon pine, fastened with $\frac{7}{8}$ -inch bolts and shimmed with oak shims. The life was approximately eight years, with an additional $1\frac{1}{2}$ years' service by repairing with wedge-shaped oak strips 3 inches wide and fastened to the worn edge of the guide with 2-inch wood screws.

It is to be noted that practically all wear is on one edge of the guide, due to the twist in the cable. Recent guide practice is to use $3\frac{3}{8}$ by 7 inch Oregon pine guides, with a 1 by $3\frac{3}{8}$ inch clear white oak wearing strip on one edge to take this wear.

The lower part of the No. 5 shaft is equipped with 8-inch, 21.5-pound ship channel guides with backs out. Plates $\frac{3}{4}$ by 5 by 8 inches are welded to the flanges for fastening to the guide-bolt sockets. These steel guides cost \$2 per foot in place, or about double the cost of Oregon pine guides, but they have given very good service and are justified.

Guide fastenings in concreted shafts.—In concreted shafts the guides are fastened to sockets or timber blocks cast in the concrete. The exact spacing and aligning of guide sockets in concrete shafts during construction are very difficult, and slight variations increase the time required to fit the guides. Moreover, after the guides are installed they may not be in perfect alignment; as a result, the shaft is "bumpy." This unevenness can be avoided (1) by framing each guide separately according to an engineer's measurements, (2) using an adjustable socket, or (3) concreting wooden blocks into the walls to which to fasten the guides.

In the Campbell shaft cast-iron receptacles are provided for the bolts for attaching the guide timbers (fig. 47). Four are used for each 20-foot guide. A double receptacle is used in the 8-inch wall between the skip compartments for holding the guides on the opposite sides of the wall, and single receptacles are used elsewhere in the shaft. The receptacle is shaped like a truncated wedge and thus provides a large bearing surface on the concrete. As stated before, short pieces of reinforcing steel are placed through the holes in the projecting lugs of the casting. Guides in this shaft are bolted to the fasteners before the concrete is poured. With this method all guides can be framed alike, but in spite of the most careful work in concreting there is some deviation from alignment. In the new Sagi-

⁵¹ Mills, C. E., Shaft Practice and Hoisting Methods at the United Verde: Min. Cong. Jour., vol. 16, April, 1930, p. 330.

naw shaft it is planned to place the guides after the concreting is finished; each guide will be framed separately to give perfect alignment. A chart will be prepared, showing the framing of each guide, so that new guides can be made for replacements without measuring the worn ones in the shaft.

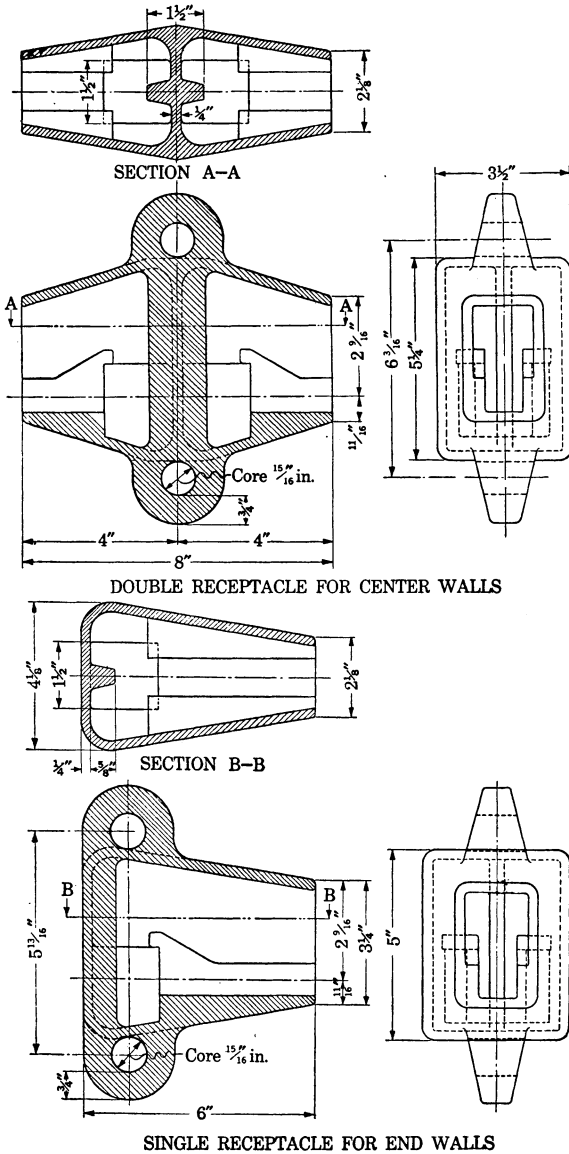

FIGURE 47.—Bolt sockets for attaching guides, Campbell shaft

In the No. 7 shaft being sunk at the United Verde a new type of receptacle or box has been designed in which the holes for the bolts holding the guides can be bored after the receptacles are in place; the guides can thus be properly aligned. Figure 48 shows the type of

guide-bolt pocket and steel guide to be used for skip compartments.⁵² These pockets will be concreted in the shaft on 6-foot centers vertically. The bolt holes are to be burned out and reamed to size after all the pockets are set; all the guides can thus be made the same. The steel guides, 6-inch ship channels weighing 15.3 pounds per foot,

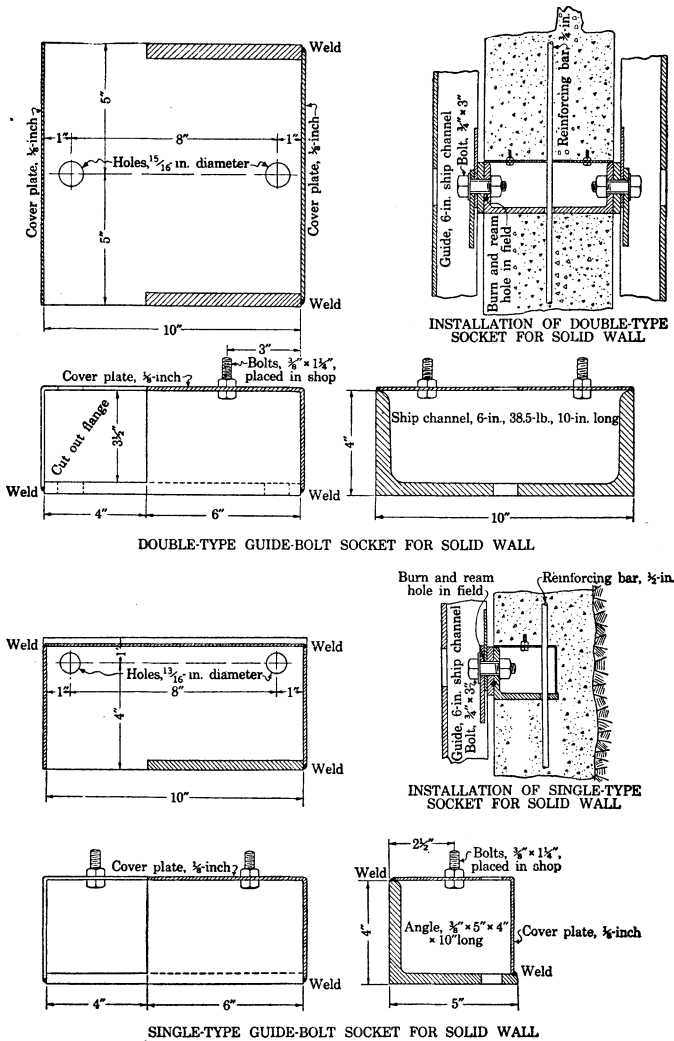

FIGURE 48.—Bolt sockets for attaching guides, skip compartment, No. 7 shaft, United Verde mine

are held to each pocket by a single 3/4-inch bolt passing through a plate welded between the flanges of the channels. Guide splices are made at the pockets by overlapping the end plates of the guides and fastening with one bolt. This method is considered simpler and more convenient than the customary method of using two pockets or 2-bolt pockets at splices.

⁵² Information furnished by H. V. Kruse, mechanical engineer, United Verde Copper Co.

In previous shaft work at this property cast-iron and cast-steel pockets have been used. The use of cast iron has been discontinued because of excessive breakage. Although satisfactory, the cast-steel pockets were expensive—about \$3.50 each. The pockets shown in the figure are being made for about \$1.25 apiece.

The cage guides will be made of wood measuring about 3½ inches by 5½ inches. The cages will be 4½ feet wide by 12½ feet long; because of this unusual length four guides are to be used in the cage compartment. The walls thereof (see fig. 1) will not be solid concrete, but rings 2 feet deep and 6 feet apart center to center. The guide supports will be short angles and channels bolted to the top of the rings. These guides will be spliced between supports. At the Magma Copper Co. mine blocks of timber are concreted in the shaft walls for guide fasteners, as shown in the longitudinal section of Figure 40. The guides are fastened to the blocks by lag screws as ordinarily used in timbered shafts. The wooden blocks have proved satisfactory under conditions at the Magma mine.

SINKING THROUGH RUNNING GROUND

IN ROCK IN PLACE

In shaft sinking running ground under hydrostatic head is occasionally encountered. At metal mines this usually occurs in faults or fractured zones where the rock has been brecciated by earth movements. Under such conditions shaft sinking is difficult. Frequently the water can be drained out and the sinking continued by ordinary methods; otherwise, spiling or forepoling must be used.

Beginning at the last set above the running ground, a bridge set is placed around or inside the regular shaft timbering and spiling of 4 by 6 inch timbers driven at an outward angle completely around the shaft. The spiling may be driven by hand or by means of a drilling machine with a special tool in the chuck.

The material within the spiling is then excavated, and breast boards are placed at the corners as the sinking progresses. Another regular set with a bridge around it is placed as soon as room is made. As excavating is continued the side pressure brings the spiling to rest on the outside of the bridge set. The next ring of spiling is then driven. The process is repeated until firm ground is reached. If the ground is so broken as to approach quicksand in character tongue-and-groove or splined spiling may be necessary. If the shaft is to be concreted the area of the shaft within the timbering should be such that the concrete can be placed without disturbing the spiling. After the concreting is finished the water may be sealed off as described later and ordinary sinking methods followed.

IN SURFACE SEDIMENTS

Most metal mines are in mountainous country where the distance to bedrock is relatively short, and as the surface soil usually is well drained no difficulties are presented in starting shafts. Frequently, however, coal, iron, and salt mine shafts and shafts for nonmining purposes such as foundations must be sunk in valley fill that con-

tains large amounts of water. Where the fill consists of silt, sand, or loose gravel the hydrostatic head increases as depth is attained and forces the material into the shaft from the sides. In such cases special methods of sinking must be followed. To avoid surface subsidence it is important to prevent any considerable flow of outside material into the shaft. Usually an almost water-tight lining must be provided.

Grouting around the shaft can not be used in loose sediments for sealing off the water. Freezing the material around the shaft to seal the water has been employed in Europe and to some extent in the United States. Usually, however, one of the two following methods is employed in sinking shafts through such material: (1) Sheet or interlocking piling is driven around the shaft section; or (2) caissons, either open or pneumatic, are constructed. The open caisson or drop shaft generally is employed.

PILING METHOD

With the piling method two sets are erected at the surface to serve as a guide; special splined or sheet-steel piles, which make a nearly water-proof joint, are then driven by a pile driver. After a row of piles is driven the shaft is excavated and timber sets placed as room is made. If solid ground is not reached by the first set of piling a second set is driven within the shaft, thus making a reduction in section of the shaft necessary. Timber piling of 6 by 12 inch material can be driven about 25 feet. Interlocking steel piling can be driven as deep as 50 feet without undue spreading at the bottom.

OPEN-CAISSON METHOD

The open-caisson method is used for relatively shallow depths in running ground. In sinking with a caisson method a permanent concrete or masonry lining with a cutting shoe is built at the surface and sunk by excavating within the lining. As the lining sinks it is built up at the surface. The advantages are that no further lining is necessary and that it can be built aboveground. The main disadvantage is that in sinking the caisson it is hard to keep it aligned, and in some instances it has been extremely difficult to sink it the required distance to solid ground. A typical example of this method of sinking was the first section of the New Orient coal shaft.⁵³ The shaft section in the clear was 9 feet by 27 feet 10½ inches, with rounded ends. The caisson was made 10 feet 6 inches by 31 feet 6 inches in section to allow for irregularities. The design showed a concrete wall 3 feet thick and heavily reinforced. The steel shoe was of angle and plate construction. The first 43 feet of material penetrated consisted of clay and loam, under which were 32 feet of running sand to bedrock. The sand contained very little water. The clay and loam were removed by a clamshell excavator; an orange-peel dipper was used in the sand. Considerable added weight had to be piled on the caisson at the surface to sink it to bedrock. It was 19 inches out of plumb at 83 feet; this distance

⁵³ Harrington, George B., *New Orient, an Unusual Coal Mine*: Trans. Am. Inst. Min. and Met. Eng., vol. 72, 1925, p. 819.

was reduced to 5½ inches at about 87½ feet from the surface, at which place a seal to the rock in place was effected.

PNEUMATIC-CAISSON METHOD

This system of sinking is similar to the open-caisson method except that the men work in a chamber at the bottom, in which a sufficient air pressure is maintained to exclude the water from the shaft. This method of sinking is employed for penetrating water-bearing measures such as silt or quicksand that could not be successfully penetrated by other methods. This method of sinking in the mining industry was illustrated at a coal mine in Indiana in sinking two shafts to bedrock where a water seal was effected.⁵⁴ The water level was at a depth of 24 feet. An open caisson was used for the first 47 feet; the next 82 were excavated by the pneumatic method. The final work was done under an air pressure of 51½ pounds to the square inch. Most of the material from within the lining in the lower section was blown to the surface through a 4 or 6 inch pipe; only a small percentage was hoisted in buckets. This method of sinking is expensive, but its use permits excavation that otherwise would not be practicable. Here the final air pressure used was the upper practicable limit under which men can work. For greater depths, where the outside hydrostatic pressure would be higher, sealing off the water would be necessary. In quicksand a method of freezing would appear to be the only practicable one.

Firms with experience in this line of work usually are given the contracts for sinking a shaft under these conditions.

SEALING WATER OUT OF SHAFTS

In countries of heavy rainfall or in valleys containing rivers or lakes shafts frequently must be sunk through consolidated strata containing large flows of water. To avoid prohibitive pumping costs or to keep the water out of soluble beds, such as in salt mines, the water must be sealed off.

As in other phases of shaft sinking a specialist should be consulted in regard to any particular problem in sealing out the water.

GROUTING

GROUTING THROUGH SHAFT LINING

Grouting the rock around the shaft apparently is the most common method of sealing out water. Two general methods of grouting are used. In the first one the shaft is sunk through the water-bearing rock and concreted either the full distance or part way at a time, depending on the conditions in the shaft and the distance to be covered. Grouting is then done through pipes laid in the concrete for the purpose. This method is effective against all heads commonly encountered in mine work. The concrete lining must be designed to resist the pressures developed. A cylindrical lining should be used where very high pressures are to be expected.

⁵⁴ Mundorf, R. F., Concrete Caisson Used to Sink Shaft Through Wet Sand: Eng. and Min. Jour., vol 116, Sept. 29, 1923, p. 535.

The second method of grouting consists of sealing off the water in the ground below the advancing face of the shaft through holes drilled for the purpose. This method is employed where the ground is open and the water pressure is such that the shaft would be flooded by water coming up through the bottom.

Grouting mixtures.—Neat cement in the form of paste as thick as can be pumped ordinarily is used for grouting ground containing small fissures or fractures. Cement and sand mixtures are adaptable for plugging large seams. The sand should pass a $\frac{1}{8}$ -inch screen, and at least 50 per cent should pass a 50-mesh sieve. Cavities or badly broken ground are sometimes temporarily stopped with sawdust, manure, or grain, and finally grouting is done with cement. Under certain conditions the rock acts as a filter and does not take enough of the cement to shut off the water. Then solutions of sodium silicate and aluminum sulphate forced into the ground in alternate pipes may effect a seal; the gelatinous precipitate which is formed when these solutions combine fills the voids. Hot asphalt may be used for the same purpose, but the fumes from the asphalt are objectionable in the confined space of a shaft.

Grout pipes.—Grout pipes are usually $1\frac{1}{2}$ or 2 inches in diameter; they are threaded on the outer ends and equipped with quick-acting valves. The spacing of the pipes depends on the amount of water and the condition of the rock. Too many pipes rather than too few should be used. Pipes for use in drill holes should be roughened on one end and wrapped with cotton wicking, burlap, or oakum before being driven into the holes.

Example of grouting through lining.—Sealing the water by grouting through the concrete lining of a shaft is illustrated in the sinking of the No. 2 shaft of the Detroit Salt Co.⁵⁵ Two shafts were sunk on this property through 100 feet of glacial fill of quicksand consistency, highly impregnated with hydrogen sulphide. Below this are about 600 feet of sandstone and limestone with numerous water-courses which are more or less continuous and connected with the Great Lakes. The hydrostatic pressure of the water at a depth of 550 feet was more than 235 pounds to the square inch. Before reconstruction No. 1 shaft was rectangular in cross section. The lining had cracked from the water pressure. Efforts to seal the water out of this shaft by grouting were unsuccessful.

No. 2 shaft was sunk 16 feet in circular section inside the lining. The lining ranged from 18 inches to 3 feet 6 inches in thickness. The minimum thickness was increased in steps of 6 inches as the shaft progressed through the water-bearing measures and reduced to 18 inches when the dry rock was reached at a depth of 672 feet. The first 92 feet of the shaft were excavated by the open-caisson method and the material inside the shaft removed with a clamshell excavator as the sinking progressed in the soft strata. From this point to the point at which dry rock was encountered sinking conditions were particularly difficult. Bearing notches were cut in the walls to support the weight of each section of concrete lining poured. When a section of the shaft was to be concreted a framework of 2 by 4 inch timber was erected to conform to the surface of the shaft. Sheet

⁵⁵ Keiser, H. D., *Mining Rock Salt in Michigan*: Eng. and Min. Jour., vol. 130, July 10, 1930, p. 16.

iron was fastened to this framework, after which the inside circular forms were placed. Grouting pipes which extended from the space back of the sheet iron carried the water through the forms. Concrete for the lining was then poured, and after it had set grout under pressure was forced into the lower grouting pipes until it flowed out of the pipe at the top, indicating that the water passages had been filled. All pipes were then plugged, and construction of the next segment was begun.

In reconstructing No. 1 shaft two circular compartments, 42 inches inside diameter, in each of which ran cages carrying three men, were left, and the remaining area of the old rectangular shaft was filled with concrete. The shaft consists essentially of a concrete monolith pierced with the two compartments. The tubes through the water-bearing strata were lined with 12-foot sections of cast-iron pipe. In reconstructing the shaft the pipe was built up from the bottom, the joints were calked, and concrete was poured around the pipes as the work progressed. A method of grouting similar to that used in No. 2 shaft was used to seal off several flows of water.

GROUTING AHEAD OF SINKING

By this method holes are drilled around the shaft section at an angle into the wall rock and extending below the next section to be sunk. Grout is forced into these holes at high pressure up to refusal, and the section is then sunk and concreted. The bottom of the shaft may also be concreted. The disadvantage of this method is that the shaft sinking is slow, as considerable time is required in drilling the holes and pumping in the grouting to effect a complete seal of the water. The use of this method is illustrated in sinking a shaft in a salt mine in Texas.⁵⁶ The shaft was sunk to a depth of 107 feet by lowering an open concrete caisson of 15 feet inside diameter, with a 4-foot wall to a sandy shale where a water seal was effected without difficulty. Sinking was then continued in dry rock to the 157-foot level. To allow sufficient cover over the expected water-bearing cap rock 40 feet below, the drilling of grouting holes was begun at this point (fig. 49). Eight holes equally spaced on a circle 15 feet in diameter were drilled with a radial slope sufficient to finish them on a 29-foot circle at the salt 57 feet below. For the first 18 feet each hole was bored 3¼ inches in diameter and a 2-inch pipe inserted, calked, and grouted in position. Drilling was then continued through these pipes with sectional rods of 1⅞-inch steel. Four holes on two lines at right angles to each other were carried down in advance of the others to allow a continuous program of alternate drilling and grouting without waiting for the grout to set. Down to 209 feet small amounts of water were encountered. These were grouted off with 127 barrels of cement; a horizontal joint 2 feet below took 168 barrels. Drilling was resumed in three holes down to 214 feet, where 200 gallons of water per minute at 80 pounds pressure with flows of sand were tapped in each hole. It became evident that the bottoms of the holes were in a 1-foot layer of running sand which made sealing the water extremely difficult. It was decided to remove the sand and replace it with grout.

⁵⁶Taylor, M., *Shaft Sinking at a Texas Salt Mine: Min. and Met.*, December, 1930, p. 580.

The shaft was sunk an additional 18 feet to decrease the length of the drill holes and still allow sufficient cover. Sixteen additional holes were drilled to 212 feet and 3,400 pounds of chemicals, consisting of sodium silicate and aluminum sulphate, and 115 barrels of cement injected to effect a seal in the rock above the sand. The holes

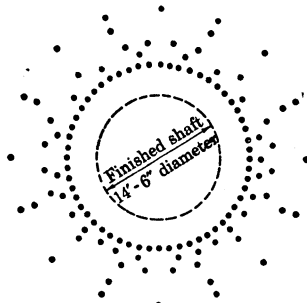
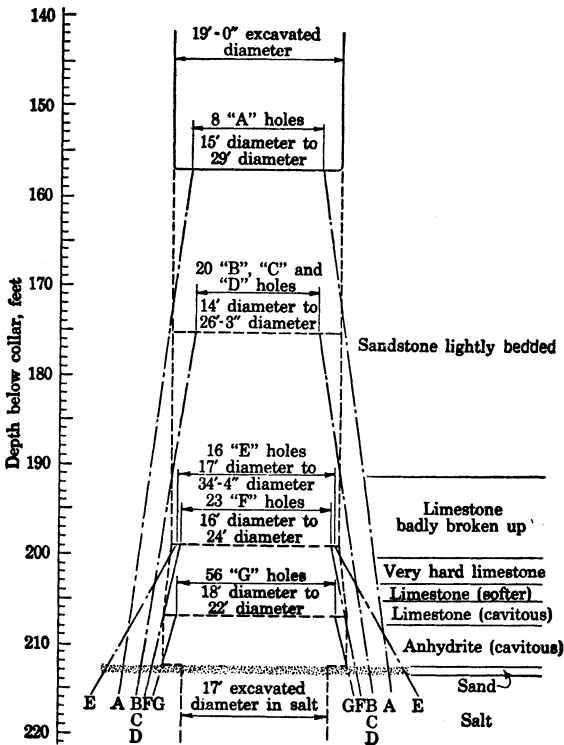

PLAN OF GROUT HOLES AT SAND

FIGURE 49.—Section of shaft showing method of grouting ahead of sinking

were then projected into the sand. The water pressure forced the sand out through the holes. At 1,000 pounds pressure 3,500 pounds of chemicals and 330 barrels of cement were injected into 14 of the holes. After the two remaining holes were drilled into the sand the water broke through the bottom of the shaft and flooded it. The

crack through which the water came was sealed with grout through a pipe, while a reverse head of water was maintained in the shaft. After the water was pumped out the shaft was sunk to the 199-foot level, after which two rows of holes were drilled, the sand jetted out, and the ground grouted. After the water was sealed the shaft was sunk an additional 8 feet, and 56 more holes were drilled and grouted. The shaft was then continued to 212½ feet and the bottom leveled with solid grout. A concrete ring was poured, the grout pierced, and the shaft sunk into the shale, where a seal was effected after some further difficulties were overcome.

Before the Longyear Co., working under contract, began sinking the Pyne shaft of the Woodward Iron Co., Woodward, Ala., a 3-inch diamond-drill hole was bored 400 feet in the center of the shaft section to allow sealing off the water ahead of sinking.⁵⁷ This hole discharged a full bore of water under a small head. To grout the water-bearing area 1,006 sacks of cement mixed with water in as thick a mixture as a Cameron pump would handle were pumped down the hole in 12 hours without the pressure gages on the pump showing any perceptible rise in pressure. Not more than 20 gallons per minute were handled from the shaft at any time, so it is assumed that the grouting stopped a considerable amount of water. The shaft section was 13 feet 1 inch by 21 feet 1 inch, outside dimensions, and had six compartments.

SEALING WATER FROM TIMBERED SHAFTS

Relatively narrow watercourses may be sealed in timbered shafts where the hydrostatic pressure is not too great by placing a puddled cement wall back of the timber lining. The shaft is first enlarged to permit two wooden forms 12 to 18 inches apart to be placed back of the regular shaft lining. A bearer set is then placed at the bottom of the water-bearing stratum and a tapered concrete ring, the bottom of which extends 4 or 5 feet from the shaft lining, is poured around the shaft. The top of the ring connects with and is an integral part of the cement wall which is extended to above the watercourse. Drainage pipes are placed above the ring to allow drainage while the cement sets. A second ring connected with the one above by a cement lining may be placed about 10 feet below the watercourse as a precautionary measure in case water gets past the first ring.

BONUS FOR LABOR

Shaftmen are highly skilled workmen and usually receive higher wages than men doing similar work elsewhere in the mine. One of the men at the bottom, acting as a leader, is customarily paid \$0.50 to \$1 per day more than the other men on the shaft crew. If the work is divided between different crews the shovelers receive less than the drillers and timbermen. Most shafts are sunk either under contract or under a bonus method of paying the workmen. Contractors usually pay the workmen \$0.50 to \$1 per day more than the standard scale in the district or allow them to participate in the earnings in accordance with some bonus plan.

⁵⁷ Stovel, J. H., *Sinking and Concreting the Pyne and Songo Shafts*: Eng. and Min. Jour., vol. 111, Apr. 23, 1921, p. 698.

When a contract is given to sink a shaft the company generally supplies timber, compressed air, tools, incidental supplies, and sometimes explosives. Under a bonus plan the men working in the bottom—that is, the drillers and shovelers—usually are guaranteed day's wages and then paid a bonus or so much per foot over a fixed standard. The standard varies at different mines. The following rates are representative of those paid.

| Mine | Number of men participating | Amount per man daily for each foot over standard | Standard, monthly average, feet per day |
|------------------------------------|-----------------------------|--|---|
| Tennessee Copper Co..... | 12 | \$2 | 2 |
| Magma Copper Co..... | 12 | 3 | 13 |
| Calumet and Arizona Mining Co..... | 18 | 2 | 3 |
| Christmas Copper Co..... | 12 | 2 | 3½ |
| Vulture Mining Co..... | 15 | 1 | 5 |

¹ 15-day average.

² Including six topmen who also participate in bonus at one-half the rate of the shaft men.

The bonus paid in sinking the Water Lily shaft, in which a world's record was made, was as follows:

| Footage made in 31-day period | Monthly bonus | | Footage made in 31-day period | Monthly bonus | |
|-------------------------------|-----------------------------------|------------------|-------------------------------|-----------------------------------|------------------|
| | Shaftmen, timbermen, shift bosses | Hoistmen, topmen | | Shaftmen, timbermen, shift bosses | Hoistmen, topmen |
| 212..... | \$15 | | 362..... | \$90 | 45 |
| 262..... | 30 | \$15 | 387..... | 105 | 45 |
| 287..... | 45 | 15 | 412..... | 120 | 60 |
| 312..... | 60 | 30 | 437..... | 135 | 60 |
| 337..... | 75 | 30 | 462..... | 150 | 75 |

The bonus paid in sinking the Seneca shaft was 2 cents per day per foot to each man for all progress made above 100 feet per month up to 150 feet. Three cents per foot was paid for footage sunk over 150 feet and not exceeding 200 feet and 4 cents per foot for all over 200 feet.

SINKING RATES

Table 4 shows sinking rates of 0.92 to 8.2 feet per day. Under adverse conditions, such as a sudden excess of water or bad ground, the rate may be lower over a month. Under the best conditions as high as 13.8 feet per day have been made over a period of a month.

In sinking the Ajax shaft a round was drilled and blasted in one shift and shoveled out in the next. Only two shifts were worked each day. The following tabulation gives the rate of sinking and other data of the shaft.

| | | |
|--------------------------------|-----------|-------|
| Total advance..... | feet..... | 502.5 |
| Elapsed time..... | days..... | 293 |
| Number of rounds..... | | 166 |
| Advance per round..... | feet..... | 3.03 |
| Advance per day..... | do..... | 1.72 |
| Average holes per round..... | | 40 |
| Footage drilled per round..... | | 158 |

| | |
|------------------------------------|--------|
| Total pieces of steel used..... | 21,004 |
| Total buckets of muck..... | 9,346 |
| Total machine shifts..... | 665 |
| Total sinking-hoist shifts..... | 430 |
| Best month's advance.....feet.. | 95 |
| Next best month's advance.....do.. | 85 |
| Poorest month's advance.....do.. | 11 |

The rate of advance in sinking No. 5 shaft of the United Verde Copper Co. is shown in the following:

| | |
|---|---------|
| Drilling speed.....inches per minute.. | 10 |
| Number of holes..... | 32-35 |
| Advance per round.....feet.. | 4.5 |
| Advance per shift.....do.. | 1.0 |
| Powder used, 1½ by 8 inch sticks per round..... | 260 |
| Powder.....cost per foot.. | \$5.20 |
| Labor excavating and timbering.....do.. | \$31.85 |

Sinking data of the Froid No. 3 shaft are as follows:

| | |
|--|---------|
| Average rate.....feet per month.. | 199.3 |
| Average length of round.....feet.. | 8.8 |
| Average time to complete a round.....hours.. | 33 |
| Record advance sinking month.....feet.. | 232 |
| Powder per foot advance: | |
| 75 per cent.....pounds.. | 50.3 |
| 40 per cent.....do.. | 18.5 |
| Total powder..... | 68.8 |
| Rock broken per foot of shaft.....tons.. | 52.5 |
| Rock broken per round.....do.. | 462 |
| Total rock broken in shaft.....do.. | 153,000 |
| Timbermen per 7-foot set.....shifts.. | 17.6 |

At the Teck-Hughes mine the advance per month in large shafts was as much as 200 feet and in winzes, including station work, 125 feet per month.

The world's record in shaft sinking was made in the Water Lily shaft at Eureka, Utah.⁵⁸ The rock conditions were favorable. Sinking was started from the surface, and no other work interfered. A description of the conditions under which the shaft was sunk and the method employed follows.

The shaft was sunk 427.5 feet in a 31-day period by the Walter Fitch, jr., Co., in 1921 for the Chief Consolidated Mining Co. The shaft contained three 4-foot 4-inch by 4-foot 6-inch compartments and had a rock section of 5 feet 9 inches by 15 feet 6 inches. The rock was porphyry and limestone. The last 60 feet of the shaft during the period the record was made was in limestone. The rounds were drilled with an average of five machines in a shift. Thirty-five per cent strength gelatin dynamite was used in the porphyry, which broke up well for shoveling, and 50 per cent strength in the limestone. The rounds were detonated with No. 8 blasting caps and fuse. Seven-eighths-inch hexagon hollow steel with the double-taper bit was used. An average of 23.9 holes was drilled per round, and an average of 15½ pounds of explosive was used per foot. An average of 2.8 sets was placed and an average of 72.5 buckets hoisted per day.

The shaft was timbered with 8 by 8 inch sets spaced at 5-foot intervals. The entire shaft was lined on the outside with 2 by 12 inch plank. The two hoisting compartments were lined on the inside

⁵⁸ Engineering and Mining Journal: Vol. 113, Jan. 14, 1922, p. 61.

with 2-inch vertical lagging to prevent the buckets from catching on the timber. Nonrotating hoisting cable was used. Hoisting was done in 17½-cubic-foot buckets in two compartments, and a manway was maintained in the third. Ventilation was through 8-inch galvanized iron pipe.

Plans were laid at the beginning to attain record speed in the work. Drilling a round, removing the spoil, and timbering, which usually are distributed over 24 hours, were shortened to 8 hours, making 3 cycles per day. It was considered that better results could be obtained by using three short rounds each day than by using one or two longer ones. Short rounds drill and break better and save explosives.

The use of two compartments with two separate hoists and the automatic dumping of the buckets accelerated the hoisting.

The timber was protected against blasting by a set of steel I beams suspended by two chain blocks below the last regular set. The blasting set when lowered served as a platform on which the timbermen worked without interfering with the drilling or shoveling below.

A bonus based on the footage sunk encouraged the men to do their best. The wage rate was as follows: Shaftmen, \$5.25; hoistmen, \$5; topmen, \$3.75.

The following gives the results obtained :

| | |
|---|-------|
| Footage sunk in 31 days..... | 427.5 |
| Average footage per day..... | 13.80 |
| Powder per foot..... pounds..... | 15.25 |
| Buckets hoisted, per shift..... | 72.5 |
| Sets installed per day..... | 2.8 |
| Timbermen per day..... | 4.8 |
| Shaftmen per shift..... | 5.7 |
| Holes drilled per round..... | 23.9 |
| Rounds per day..... | 3 |
| Delay on account of power failure and hoist repairs..... hours..... | 13 |

The following tabulation shows the number of men employed per day :

| Classification | Shift | | | Total |
|-------------------|-----------------------|------------------------|------------------------|-------|
| | 8 a. m. to 4 p. m. | 4 p. m. to 12 a. m. | 12 a. m. to 8 a. m. | |
| Shift bosses..... | 1 | 1 | 1 | 3 |
| Timbermen..... | 4 | 2 | 0 | 6 |
| Shaftmen..... | 6 | 6 | 6 | 18 |
| Hoistmen..... | 2 | 2 | 2 | 6 |
| Topmen..... | 2 | 2 | 2 | 6 |

The following tabulation gives data on sinking the McIntyre No. 11 shaft,⁵⁰ excluding stations and crosscuts. The figures are monthly averages for 25 months.

| | | |
|--|-----------|----------|
| Rock section of shaft..... | feet..... | 17 by 20 |
| Depth sunk..... | do..... | 4,071 |
| Rock hoisted..... | tons..... | 160,000 |
| Water hoisted..... | do..... | 40,000 |
| Average monthly advance..... | feet..... | 161.1 |
| Average advance per round..... | do..... | 10.2 |
| Average number of holes per round..... | | 66.6 |

⁵⁰ Kee, H. A., Sinking Operations at the McIntyre No. 11 Shaft, Porcupine District, North Ontario: Canadian Min. and Met. Bull., April, 1928, p. 510.

| | |
|---|-------------------------|
| Feet drilled per round..... | 772.2 |
| Feet drilled per steel sharpened..... | 7.2 |
| Average number of steels used per round..... | 113.5 |
| Explosives, 40 and 50 per cent gelatin: | |
| Per foot of advance..... pounds.. | 50.10 |
| Per ton rock broken..... do..... | 1.51 |
| Holes reblasted..... per cent.. | Less than $\frac{3}{4}$ |
| Number of known missed holes..... | 3 |
| Rock broken per foot of hole drilled..... cubic feet.. | 5.41 |
| Rock broken per pound of explosive..... do..... | 8.21 |
| Average number of buckets hoisted per round..... | 220.7 |
| Board feet of timber per foot of shaft..... | 546 |
| Per shaft man-shift: | |
| Rock hoisted..... tons.. | 4.75 |
| Water hoisted..... do..... | 1.8 |
| Timber placed..... board feet.. | 79.1 |
| Holes drilled..... feet.. | 10.7 |
| Rock hoisted per man per mucking hour..... tons.. | 1.10 |
| Average bonus paid per shift to each shaftman..... | \$2.00 |
| Average daily earnings all men below collar..... | \$7.98 |
| Hoist: 600 hp., 8-foot drums; hoisting speed, 1,850 feet per minute. | |
| Actual working days, including 19 stations and 600 feet of crosscutting.. | 761 |
| Lost time, for mechanical reasons..... per cent.. | 3.2 |
| Lost time, Sundays and holidays..... do..... | 4.8 |

COST OF SINKING SHAFTS

As discussed previously, the cost of sinking a shaft depends on the size and depth of shaft, hardness of rock, sinking equipment available, organization, and the amount of water to be pumped. The labor cost of removing the broken rock usually is more than all other labor charges combined in connection with sinking. As the amount of material hoisted is in direct proportion to the cross section of the shaft the size directly affects this part of the expense of sinking. Other charges—drilling, timber, and explosive—also increase with the size of the shaft but not in direct proportion. The proportional increase in cost usually is between 60 and 70 per cent of the increase in size. As shown by Table 5, the direct cost of sinking the Magma No. 5 shaft was \$104.50 per foot and the No. 6, \$79.28. Except for size, conditions were nearly comparable at both places. In sinking these two shafts the costs are almost in direct proportion to the size of the shafts.

The depth of the shaft affects the cost of sinking, as more expensive equipment is required for sinking long lifts and more time is required to hoist the broken rock. Hard rock requires more time to drill and more explosive to break. This extra cost may be partly offset by a saving in timbering; in hard rock the sets are not kept so near the bottom and two or more may be placed at a time.

Delays resulting from poor equipment increase the cost of sinking. A balance must be drawn between first cost of equipment and the work to be done. More expensive machinery can be bought for sinking a long distance than for sinking a short one.

Poor organization and supervision increase the cost of shaft sinking to a marked extent. A bonus paid to the workmen for speed usually results in a lower over-all cost. Costs generally are lowered as the organization is completed and sinking technique perfected.

Water in shafts increases the costs of sinking, usually in proportion to the amount of water to be handled. With adequate pumping equipment, however, delays due to water can be kept to a minimum.

Where sinking a shaft is the only mining work in progress sinking costs are naturally higher, as all the time of compressor men, blacksmiths, surface labor, bosses, and other workmen is charged against the operation. In some instances costs have been 50 to 100 per cent higher than if other operations had absorbed part of the overhead.

As no two mining companies keep cost records in the same manner all of the individual operations in shaft sinking can not be compared accurately. Some companies charge such items as drill repairs and incidental shop work to shaft sinking, whereas others do not.

Direct sinking costs only are comparable, as new equipment and surface preliminary work, which should be justly charged against the job, are not the same at any two places. For example, if a company has a sinking hoist in stock only the cost of installing may be charged against the shaft. A new hoist may be purchased and charged against the first section of the shaft sunk at one place and against the ultimate depth at another.

Table 5 gives sinking costs at representative shafts. Some of the figures shown as totals are only partial costs, as all items of expense are not included. It will be noted that direct costs range from \$15.63 in the Tri-State district for sinking a 5 by 7 foot shaft 260 feet deep to \$120.74 at the Teck-Hughes for sinking a 14 by 15 foot shaft 3,600 feet deep. Partial costs of raising shafts are shown under the section, Raising Shafts. Complete costs at a few mines are shown in Table 5.

TABLE 5.—Total sinking costs per foot

| | Capote shaft, Cananea Consolidated Copper Co. | No. 5 shaft, Magma Copper Co. | No. 6 shaft, Magma Copper Co. | No. 5 shaft, United Verde Copper Co. | Average of 3 shafts, Tri-State district | Saginaw shaft, Calumet and Arizona Min. Co. | Main shaft, Pecos mine American Metal Co. of New Mexico |
|---------------------------------------|---|-------------------------------|-------------------------------|--------------------------------------|---|---|---|
| Total direct costs ¹ | \$104.95 | \$104.50 | \$79.28 | \$101.09 | \$15.63 | \$63.39 | \$101.50 |
| New equipment charged to sinking: | | | | | | | |
| Drills, steel, hose..... | 7.89 | | | | 1.37 | | 8.57 |
| Hoists..... | | 1.95 | ² 9.09 | | | ³ 5.86 | |
| Pumps..... | | 1.10 | ² 3.17 | | | | |
| Motors..... | | .84 | | | | 4.15 | |
| Skips and cages..... | | 1.48 | | | | 2.05 | |
| Miscellaneous..... | | | | | 3.20 | ⁴ 7.96 | |
| Total..... | 7.89 | 5.37 | 12.26 | | 4.57 | 20.02 | 8.57 |
| Preparatory expenses: | | | | | | | |
| Labor— | | | | | | | |
| Shaft collar..... | | .34 | | | | | |
| Headframe..... | | .47 | .55 | | | ⁵ 5.53 | 1.55 |
| Buildings..... | | 1.19 | .73 | | | 2.00 | |
| Miscellaneous..... | | 1.25 | ⁶ 9.79 | | | | 1.21 |
| Total..... | 4.47 | 3.25 | 11.07 | ⁷ 9.03 | | 7.53 | 2.76 |
| Supervision..... | | | | 2.00 | | | |
| Supplies— | | | | | | | |
| Shaft collar..... | | .97 | | | | | |
| Headframe..... | | .65 | .49 | | | | |
| Buildings..... | | .20 | .64 | | | 1.62 | |
| Miscellaneous..... | | 1.50 | ³ 3.88 | | | | |
| Total..... | 5.33 | 3.32 | | ⁸ 11.56 | | | |
| Total preparatory..... | 9.80 | 6.57 | 5.01 | ⁸ 11.59 | | 9.15 | 2.76 |
| Grand total sinking..... | 122.66 | 116.44 | 107.62 | 112.68 | 20.20 | 92.56 | 112.83 |

¹ See Table 4.² Includes motors and installation.³ Moving and erection only.⁴ Power lines and moving compressor.⁵ Moving and erection.⁶ Adit and station.⁷ Includes electric power lines, dumps, skips, shaft collar, excavation, moving hoist, and miscellaneous.⁸ Preparatory expense prorated over 600 feet—the total distance to be sunk in lift.

TABLE 5.—Total sinking costs per foot—Continued

| | No. 3 shaft, Vulture mine, United Verde Ex- tension Mining Co. | No. 1 shaft, Bunker Hill & Sul- livan Min- ing & De- velopment Co. | Water Lilly shaft, Chief Consoli- dated Min- ing Co. (Walter Fitch, jr., Co.) | 700 winze, Grand Central mine, Chief Consoli- dated Min- ing Co. | No. 2 shaft, Errington mine, Treadwell Yukon (Ltd.) |
|---------------------------------------|--|--|--|--|--|
| Total direct costs ¹ | \$47. 00 | \$54. 20 | \$57. 71 | \$10. 64 | \$93. 39 |
| New equipment charged to sinking: | | | | | |
| Drills, steel, hose..... | | 1. 82 | 1. 92 | . 81 | . 69 |
| Hoists..... | | . 93 | . 89 | . 17 | |
| Pumps..... | | 1. 11 | | | |
| Motors..... | | | | | |
| Skips and cages..... | | . 13 | . 08 | . 07 | |
| Miscellaneous..... | | . 20 | . 13 | | |
| Total..... | 26. 00 | 4. 19 | 3. 02 | 1. 05 | . 69 |
| Grand total sinking..... | 73. 00 | 58. 39 | 60. 73 | 11. 69 | 94. 08 |

¹ See Table 4.

The following tabulations show partial costs which have been given in as unsegregated form.

| | | | | | |
|--|--|--|------------|----------|----------|
| Shaft (Waco district): ⁶⁰ | | | | | |
| Shaft section..... | | | feet.. | 4 by 6 | |
| Contract price, labor and explosives..... | | | | | \$10 |
| Hartley-Grantham shaft (Tri-State district): ⁶¹ | | | | | |
| Shaft section..... | | | feet.. | 6 by 6 | |
| Contract price, labor and explosives— | | | | | |
| In shale..... | | | per foot.. | | \$7 |
| In limestone..... | | | do..... | | \$10. 50 |
| Total cost to company..... | | | do..... | | \$18 |
| Mine shaft (Tri-State district): ⁶² | | | | | |
| Shaft section..... | | | feet.. | 5 by 7 | |
| Depth..... | | | do..... | | 270 |
| Contract price, labor and explosives— | | | | | |
| In shale..... | | | | | \$12 |
| In solid rock..... | | | | | \$18 |
| Quapaw lease (Tri-State district): ⁶² | | | | | |
| Shaft section..... | | | feet.. | 6 by 6 | |
| Depth..... | | | do..... | | 255 |
| Contract price— | | | | | |
| In rock..... | | | per foot.. | | \$13 |
| In overburden..... | | | do..... | | \$9 |
| Cribbing (where timbered)..... | | | do..... | | \$5. 86 |
| Power and general cost..... | | | do..... | | \$3. 32 |
| Total cost..... | | | do..... | | \$16. 50 |
| (NOTE: The contract for this shaft included every item of cost except power, timbering materials, and general expenses.) | | | | | |
| Nevada-Massachusetts shaft (Nevada): ⁶³ | | | | | |
| Shaft section..... | | | feet.. | 5½ by 10 | |
| Inclination..... | | | degrees.. | | 75 |
| Contract price for sinking (dry), shaft men only..... | | | | | \$15 |
| Contract price for sinking (wet), shaft men only..... | | | | | \$25 |
| Mineville shaft (New York): ⁶⁴ | | | | | |
| Shaft section..... | | | feet.. | 10 by 20 | |
| Inclination..... | | | degrees.. | | 25 |

⁶⁰ Banks, Leon M., Mining Methods and Costs in the Waco District: Inf. Circ. 6150, Bureau of Mines, 1929, 10 pp.

⁶¹ Keener, Oliver W., Methods and Costs of Mining at Hartley-Grantham Mine, Tri-State Zinc and Lead District: Inf. Circ. 6236, Bureau of Mines, 1930, 8 pp.

⁶² Original sources.

⁶³ Heizer, Ott F., Method and Cost of Mining Tungsten Ore at the Nevada-Massachusetts Co., Mill City, Nev.: Inf. Circ. 6284, Bureau of Mines, 1930, 13 pp.

⁶⁴ Cummings, A. M., Method and Cost of Mining Magnetite in the Mineville District, New York: Inf. Circ. 6092, Bureau of Mines, 1928, 12 pp.

| | |
|-----------------------------------|----------|
| Direct sinking costs— | |
| Drilling and blasting | \$13. 10 |
| Mucking and hoisting | 12. 40 |
| Track, air, and water lines | 4. 00 |
| Miscellaneous | 2. 80 |

Total

32. 30

Argonaut shaft (California):⁶⁵

| | | |
|--|---------|---------|
| Shaft section | feet | 9 by 17 |
| Inclination | degrees | 70 |
| Progress per month | feet | 80 |
| Contract price for shaft, labor only | | \$45 |

Ajax shaft, Cripple Creek (Colo.):⁶⁶

| | | |
|---------------------|------|---------|
| Shaft section | feet | 7 by 16 |
| Depth sunk | do | 502. 5 |

| Labor costs | Average wage | Total cost | Cost per foot | Per cent |
|--------------------------------|--------------|--------------|---------------|----------|
| Machine men | \$5. 25 | \$3, 271. 84 | \$6. 511 | 11. 4 |
| Muckers | 4. 50 | 3, 251. 18 | 6. 470 | 11. 3 |
| Timbermen | 5. 25 | 2, 567. 89 | 5. 110 | 8. 9 |
| Sinking hoistmen | 4. 13 | 1, 885. 56 | 3. 753 | 6. 6 |
| Shaft bosses | 5. 00 | 756. 67 | 1. 506 | 2. 6 |
| Machinist and blacksmith | 4. 50 | 246. 79 | . 491 | . 8 |
| Topmen and skippers | 4. 00 | 598. 94 | 1. 192 | 2. 1 |
| Pipemen and repairmen | 4. 00 | 369. 58 | . 735 | 1. 3 |
| Totals | | 12, 948. 57 | 25. 768 | 45. 0 |

McPherson shaft, Tennessee Copper Co. (Tennessee):⁶⁷

| | | |
|---------------------------------------|------|----------|
| Shaft section | feet | 10 by 19 |
| Advance per day | do | 2. 3 |
| Total labor | | \$41. 02 |
| Explosives | | 5. 80 |
| Material (excluding explosives) | | 14. 63 |
| Total power | | 4. 09 |

Total direct cost

65. 54

Colorada shaft, Cananea Consolidated Copper Co. (Mexico):⁶⁸

| | | |
|----------------------|------|----------|
| Shaft section | feet | 8 by 22 |
| Direct sinking cost— | | |
| Labor | | \$43. 46 |
| Supplies | | 27. 26 |
| Power | | 2. 44 |
| Sundries | | 1. 02 |

Total

74. 18

Randfontein ventilation shaft (South Africa):⁶⁹

| | | |
|--|----------|----------|
| Shaft-section (round) diameter | feet | 23½ |
| Progress, 4-foot rounds, per shift | | 1 |
| Rock hoisted per round | tons | 180 |
| Three-ton buckets | per foot | 13 to 15 |
| Depth sunk | feet | 3, 421 |
| Thickness concrete lining | inches | 9 |

⁶⁵ Vanderburg, W. O., Mining Methods and Costs at the Argonaut Mine, Amador County, Calif.: Inf. Circ. 6311, Bureau of Mines, 1930, 15 pp.

⁶⁶ Black, W. S., Cost of Shaft Sinking at Cripple Creek: Eng. and Min. Jour., vol. 120, Aug. 15, 1925, p. 255.

⁶⁷ Weaver, Lamar, Shaft Sinking in Tennessee: Eng. and Min. Jour., vol. 129, Mar. 24, 1930, p. 302.

⁶⁸ Catron, William, Mining Methods, Practices, and Costs of the Cananea Consolidated Copper Co., Cananea, Sonora, Mexico: Inf. Circ. 6247, Bureau of Mines, 1930, 41 pp.

⁶⁹ Nixon, W. G. C., Sinking of the Randfontein Ventilation Shaft: Eng. and Min. Jour., vol. 124, Oct. 29, 1927, p. 692.

| | | |
|--|---------------------|----------------|
| Costs per foot— | | |
| Sinking | ----- | \$72. 00 |
| Concrete lining | ----- | 37. 32 |
| Hoisting | ----- | 14. 97 |
| Shaft equipment | ----- | 10. 01 |
| Surface equipment | ----- | 24. 12 |
| Total | ----- | <u>158. 42</u> |
| Magma No. 7 shaft (Arizona): ⁷⁰ | | |
| Shaft section | ----- feet | 7½ by 16½ |
| Footage sunk | ----- | 1, 465 |
| Preliminary to sinking— | Amount | Cost per foot |
| Labor | \$2, 494. 15 | \$1. 71 |
| Supplies | 1, 730. 64 | 1. 19 |
| Total preliminary cost | <u>4, 224. 79</u> | <u>2. 90</u> |
| Sinking— | | |
| Jiggers | 6, 384. 64 | 4. 39 |
| Shaft men | 15, 100. 75 | 10. 37 |
| Top landers | 3, 810. 76 | 2. 62 |
| Bonus | 32, 075. 98 | 22. 03 |
| Explosives | 8, 062. 34 | 5. 54 |
| Timber material | 14, 857. 93 | 10. 20 |
| Pumping and drainage— | | |
| Labor | 113. 57 | . 08 |
| Supplies | 74. 25 | . 05 |
| Air and water lines— | | |
| Labor | 179. 75 | . 12 |
| Supplies | 934. 50 | . 64 |
| Ventilation— | | |
| Labor | 34. 10 | . 02 |
| Supplies | 492. 00 | . 34 |
| Power lines— | | |
| Labor | 39. 12 | . 03 |
| Supplies | 26. 76 | . 02 |
| Dump— | | |
| Labor | 377. 81 | . 26 |
| Supplies | 76. 70 | . 05 |
| Sinker hoist operation and repairs— | | |
| Labor, operation | 4, 927. 43 | 3. 38 |
| Labor, repairs | 1, 984. 44 | 1. 36 |
| Supplies | 985. 14 | . 68 |
| Power | 318. 91 | . 22 |
| Telephones and signals— | | |
| Labor | 44. 97 | . 03 |
| Supplies | 63. 51 | . 04 |
| Skips and cages— | | |
| Labor | 153. 04 | . 10 |
| Supplies | 37. 11 | . 03 |
| Miscellaneous— | | |
| Labor | 1, 588. 81 | 1. 09 |
| Supplies | 1, 202. 95 | . 83 |
| Timber framing— | | |
| Labor | 2, 062. 61 | 1. 42 |
| Compressed air | 1, 685. 16 | 1. 16 |
| Total direct sinking | <u>97, 695. 04</u> | <u>67. 10</u> |
| Total direct cost | <u>101, 919. 83</u> | <u>70. 00</u> |
| Hoist installation— | | |
| Labor | 886. 22 | ----- |
| Supplies | 567. 99 | ----- |
| Headframe— | | |
| Labor | 975. 70 | ----- |
| Supplies | 574. 14 | ----- |

⁷⁰ Original sources.

EXCAVATING SHAFTS

101

| | Amount | Cost per foot |
|--------------------------|---------------------|---------------|
| Change room— | | |
| Labor..... | 317. 81 | ----- |
| Supplies..... | 440. 05 | ----- |
| Concreting collar..... | 1, 623. 30 | ----- |
| Stations— | | |
| Labor..... | 928. 04 | ----- |
| Supplies..... | 211. 30 | ----- |
| Tail drifts— | | |
| Labor..... | 913. 33 | ----- |
| Supplies..... | 231. 36 | ----- |
| Total indirect cost..... | <u>7, 669. 24</u> | <u>5. 24</u> |
| Total cost..... | <u>109, 589. 07</u> | <u>75. 24</u> |

Bisbee Queen shaft (Arizona):⁷¹

| | | |
|--|-----------|--------------|
| Rock section..... | feet..... | 7 by 17 |
| Depth sunk..... | do..... | 0 to 823 |
| Depth per round..... | do..... | 5 |
| Depth per day..... | do..... | 7 |
| Depth per month..... | do..... | 235 |
| Contract, breaking and explosives..... | | \$40. 00 |
| Bonus made by shaftmen per day..... | | <u>3. 50</u> |

Cost—

| | |
|---------------------------|--------------|
| Shaft labor per foot..... | 30. 93 |
| Blacksmiths (2)..... | 2. 07 |
| Timber framers..... | 2. 84 |
| Hoist engineers..... | <u>2. 77</u> |

Total labor..... 38. 61

| | |
|---------------------|--------------|
| Explosives..... | 5. 49 |
| Timber..... | 7. 60 |
| Other supplies..... | <u>7. 40</u> |

Total supplies..... 20. 49

| | |
|-------------------------|--------------|
| Power..... | 2. 39 |
| Insurance..... | 2. 15 |
| Trucking..... | 1. 31 |
| Office and general..... | 2. 06 |
| Preliminary work..... | <u>2. 14</u> |

10. 05

Total sinking..... 69. 15

Bawdwin 3-compartment shaft (Upper Burma):⁷²

| | | |
|---------------------------------|--------------------|----------------|
| Size of shaft..... | feet in clear.. | 4½ by 11 |
| Water..... | gallons per hour.. | 5,000 to 5,500 |
| Labor, 461 coolies on 3 shifts. | | |
| Advance per month..... | feet..... | 33 |
| Cost per foot— | | |

| | Rupees (\$0. 20) | Dollars |
|------------------------------|---------------------|---------|
| Labor..... | 58. 0 | 16. 82 |
| Supervision..... | 36. 0 | 10. 44 |
| Explosives..... | 34. 0 | 9. 86 |
| Timber..... | 28. 0 | 8. 12 |
| Pumping..... | 36. 0 | 10. 44 |
| General expenses..... | 4. 5 | 1. 31 |
| Engineering..... | 1. 5 | . 43 |
| Mine ventilation..... | 1. 0 | . 29 |
| Repairs and maintenance..... | 29. 0 | 8. 41 |
| Lighting..... | 8. 0 | 2. 32 |
| Compressed air..... | 3. 0 | . 87 |
| Hoisting..... | 2. 5 | . 72 |

⁷¹ Original sources.

⁷² Calhoun, A. B., Mining Methods at the Bawdwin Mine: Trans. Am. Inst. Min. and Met. Eng., vol. 69, 1923.

| | Rupees (\$0.29) | Dollars |
|--|--------------------|----------------|
| Assaying and sampling..... | 2. 0 | 0. 58 |
| Steel..... | 1. 0 | . 29 |
| Sundries..... | 10. 0 | 2. 90 |
| Total..... | 254. 5 | 73. 80 |
| Homestake interior shaft (South Dakota): | | |
| Size of shaft..... feet rock section.. | | 8 by 14 |
| Number of compartments..... | | 2 |
| Size of compartments..... feet.. | | 5½ by 5½ |
| Size of timber in sets..... inches.. | | 12 by 12 |
| Depth of rounds..... feet.. | | 6 to 7 |
| Number of holes to a round..... | | 32 |
| Explosive used—40 per cent gelatin dynamite.. pounds per foot.. | | 23. 1 |
| Number of men on contract..... | | 9 |
| Number of topmen paid on company account..... | | 2 |
| Contract price for labor and explosives, per foot..... | | \$35. 00 |
| Cost of explosives, detonators, wire, etc., per foot..... | | \$6. 64 |
| Vallecito drift mine (California): | | |
| Size of shaft..... feet in clear.. | | 4 by 7½ |
| Depth of shaft..... feet.. | | 143 |
| (Shaft sunk through cemented gravel.) | | |
| Number of compartments..... | | 2 |
| Size of compartments..... feet.. | | 4 by 4½ |
| Size of timber of sets..... inches.. | | 4 by 2½ |
| Cost of timber per M board feet..... | | 8 by 8 |
| (Water pumped from 12-inch churn-drill hole, put down prior to sinking, by means of a deep-well pump.) | | \$42. 00 |
| Pump motor..... hp.. | | 20 |
| Water handled..... gallons per minute.. | | 35 |
| Sinking progress per day..... feet.. | | 1 |
| Total cost of sinking per foot..... | | \$39. 50 |
| Fresnillo Co., general shaft (Fresnillo, Mexico):⁷³ | | |
| Size of shaft..... feet rock section.. | | 8 by 33 |
| Number of compartments..... | | 5 |
| Distance apart of sets..... feet.. | | 6 |
| (Sets 6-inch H-steel; no lagging used—ground hard.) | | |
| Costs per foot— | | |
| Excavation..... | | \$41. 94 |
| Timbering..... | | 116. 61 |
| Tramming and hoisting..... | | 11. 10 |
| Explosives..... | | 9. 50 |
| Miscellaneous..... | | 14. 93 |
| Total..... | | 194. 08 |
| Recapitulation— | | |
| Labor..... | | \$90. 18 |
| Supplies..... | | 99. 02 |
| Power..... | | 4. 88 |

These figures include all items chargeable against the shaft. The cost of the concrete collar, the loading pockets for the 105-m and 165-m levels, and the construction of the surface bins is included. The cost of the headframe, hoist, and other equipment is not included.

COST OF CONCRETING

Table 6 gives segregated costs of concreting in six shafts. The prices per foot of shaft in these cases range from \$31.35 to \$196.61. The average cost per cubic yard of concrete is about \$25. Costs of concreting by the ring method and by using concrete cribbing are given under Concreting.

⁷³ Livingston, A., Mining Methods and Costs at Fresnillo, Mexico; Inf. Circ., Bureau of Mines (in prep.).

EXCAVATING SHAFTS

TABLE 6.—Costs of concreting at representative shafts

| Mine | United Verde Extension | | United Verde Copper Co. | | Magma Copper Co. | | Calumet and Arizona Mining Co. (1921) | Morning mine, Federal Mining & Smelting Co. (1925) | Sevier Valley Coal Co. (1931) |
|---------------------------------|------------------------|------------------|---------------------------------|-------------------------------|---------------------------------|---------------------------------|---------------------------------------|--|-------------------------------|
| | Cost plus plan | Bonus plan | Solid walls | Rings | 1922 | 1930 | | | |
| Shaft | Edith, 5 by 14-6 | Edith, 5 by 14-6 | No. 6, 1-13 by 13, 14-4 by 14-4 | No. 6, 13 by 13, 14-4 by 14-4 | No. 2, 4-6 by 12-9, 5-4 by 14-7 | No. 2, 4-6 by 12-9, 5-4 by 14-7 | Campbell, 10-8 by 15-8, 216 sq. ft. | Main, 5 by 22.5, 9 by 26 | Main, 12-6 by 25, 17 by 25 |
| Section inside concrete | 0 | 3 10 | 8 | 8 | 3 | 3 | 12-24 | 12-36 | 12-48 |
| Section, rock | 1:2:5 | 1:2:5 | 1:3:5 | 1:2:4 | 1:2:4 | 1:2:4 | 1:2:5 | 1:2:3 | ----- |
| Number of compartments | 0 | 3 | 4 | 4 | 3 | 3 | 0 | 2, 450 | 0 |
| Thickness of concrete | 1:2:5 | 1:2:5 | 1:3:5 | 1:2:4 | 1:2:4 | 1:2:4 | 1:2:5 | 2, 560 | 182 |
| Feet | 0 | 575 | 500 | 1, 950 | 590 | 2, 886 | 0 | 2, 560 | 182 |
| From | 575 | 1, 205 | 1, 950 | 3, 000 | 1, 200 | 3, 184 | 1, 520 | 2, 110 | 182 |
| Distance considered | 575 | 1, 630 | 1, 080 | 1, 550 | 610 | 2, 298 | 1, 520 | 1, 8 | 182 |
| Average daily advance | 7.19 | 9.13 | ----- | ----- | 7.2 | 10.0 | ----- | ----- | 1.0 |
| Costs per foot | \$15.35 | \$8.04 | ----- | 4 \$22.50 | \$19.65 | \$12.71 | \$14.81 | \$71.44 | \$42.00 |
| Labor | 5.34 | 3.26 | ----- | 1.36 | 1.36 | 5.31 | ----- | 5.88.11 | 5.43 |
| Engineering and supervision | 19.07 | 16.62 | ----- | 19.76 | 19.76 | 20.43 | ----- | 6 49.95 | ----- |
| Concrete | 1.00 | 1.00 | ----- | 5.13 | 5.13 | 5.00 | 24.99 | 7.6.20 | ----- |
| Reinforcing iron | 1.50 | 1.50 | ----- | 2.70 | 2.70 | 2.88 | 8 8.52 | 9 13.50 | ----- |
| Form lumber | 26.91 | 22.38 | ----- | 26.51 | 32.90 | 40.71 | 34.08 | 69.65 | 117.50 |
| Total supplies | 8.88 | 9.83 | ----- | ----- | 3.18 | 4.28 | ----- | 3.43 | ----- |
| Power | 43.14 | 31.35 | ----- | ----- | 3.79 | 4.28 | ----- | 13.98 | ----- |
| Miscellaneous | 68.17 | 68.17 | \$146.84 | 50.11 | 60.88 | 57.80 | 48.89 | 10 196.61 | 164.93 |
| Total | ----- | ----- | 215.01 | 77.11 | 70.99 | 51.60 | 95.51 | 115.45 | 51.60 |
| Excavation | ----- | ----- | 61.30 | 127.22 | ----- | 128.79 | 144.60 | 312.06 | 216.53 |
| Grand total | ----- | ----- | ----- | 58.80 | ----- | ----- | 18.31 | 11 49.63 | 23.00 |
| Cost per cubic yard of concrete | ----- | ----- | ----- | ----- | ----- | ----- | ----- | ----- | ----- |

1 Shaft raised full section. Costs do not include steelwork (see fig. 44), ladders, or pipe lines.
 2 Shaft contained 6 pipes in sizes ranging from 2 to 4 inches set in concrete in 1 wall.
 3 2½-foot rings on 6-foot centers.
 4 Includes \$5.90 for shop labor.
 5 Includes contractor's profit.
 6 Cost of handling material to mixer was \$25.71 per foot, not included.
 7 Cost of handling iron to shaft was \$1.35 per foot, not included.
 8 Forms of steel.
 9 Includes \$5.48 per foot for surface labor.
 10 Indirect costs, including preparing shaft for concreting, building bulkheads, making designs, and testing materials, was an additional \$27 per foot.
 11 Total cost per cubic yard, including indirect costs, \$56.91.

SUMMARY

The present tendency is to sink shafts with a more nearly square section than those formerly sunk to provide large compartments for cages on which loaded timber trucks can be run. Round shafts are used where hydrostatic pressure is to be withstood. Vertical shafts are preferred except in bedded deposits and veins dipping about 45°.

The practice differs in various places in regard to sinking or raising shafts where either is practicable. In general, sinking is preferred where long lifts are necessary, especially in rock of high temperature. The usual method of raising shafts is to first run a pilot raise through to a connection and then enlarge the raise to full shaft section either by blasting out rings or by shrinkage stopping.

Specialists are required for all shaft-sinking operations to obtain low costs. Proper planning of the work as well as trained crews are necessary. A bonus plan by which the workmen receive extra compensation for speed or extra effort usually lowers the sinking costs. At American metal mines sinking crews usually consist of one man to about each 20 square feet at the bottom. Where coolie or similar labor is employed three to four times the number of men per square foot may be used. Top crews consist of one to three men.

Sinking operations usually extend over 24 hours per day. The men at the bottom usually perform the work at hand, whether drilling, shoveling, or timbering. Apparently the best results ordinarily are obtained where the depth of round is such that a cycle can be made each 24 hours.

Generally shafts are timbered as sunk. Important shafts at coal and nonferrous metal mines usually are lined with concrete. Steel sets are favored at iron mines.

The cost of sinking shafts depends on the size of the shaft, the length of the lift, the sinking equipment available, the material through which the shaft is sunk, and the amount of water handled. The rate of sinking ranges from less than 1 foot to 13.6 feet per day. A trained crew under normal conditions will sink between 5 and 6 feet per day in a 3-compartment shaft. The direct cost of sinking a shaft ranges from \$16 per foot in 4 by 6 foot shafts less than 300 feet deep to several hundred dollars for deep shafts under adverse conditions.

For a 3-compartment shaft under average conditions the direct cost should be about \$70 per foot and the total cost \$90 to \$125, depending on the necessary preparatory work and amount of new equipment purchased. Concreting costs will range from \$30 to \$300, depending on conditions.

INDEX

| | Page | | Page |
|---|----------------|---|--------------------|
| Air lines, for drills, size----- | 23 | Arizona, Magma Copper Co., Magma | |
| Ajax mine. <i>See</i> Colorado, Ajax Gold | | mine, concreting----- | 67, |
| Mining Co.; Colorado, | | | 68, 69, 72, 73 |
| Tonopah-Ajax Mining | | costs----- | 103 |
| Co. | | diagram----- | 73 |
| Alabama, Woodward Iron Co., Pyne | 67, 79 | guides----- | 86 |
| shaft, concrete linings----- | | guniting----- | 65 |
| diagram----- | 79 | diagram----- | 66 |
| water, sealing----- | 92 | manifold for drills, diagram----- | 22 |
| Alaska, Alaska-Juneau Gold Mining | | practice----- | 23 |
| Co., Alaska-Juneau | | primers----- | 31, 32 |
| mine, sinking costs, | 93 | rotation of holes----- | 32, 33 |
| table----- | | shaft rounds----- | 26 |
| sinking practice, table----- | 1 | sinking costs, table----- | 93 |
| Alaska-Juneau Gold Mining Co. | | sinking practice, costs----- | 96, 100 |
| <i>See</i> Alaska. | | table----- | 1 |
| Alaska-Juneau mine. <i>See</i> Alaska, | | timbering----- | 50, 51, 52, 55, 57 |
| Alaska-Juneau Gold | | diagram----- | 55 |
| Mining Co. | | Miami Copper Co., Miami mine, | |
| Alford, N. G., work cited----- | 66 | shaft, dimensions----- | 2 |
| Alpha shaft. <i>See</i> Nevada, Consoli- | | rounds----- | 24 |
| dated Coppermines. | | Phelps Dodge Corporation, Mor- | |
| American Metal Co. <i>See</i> New Mex- | | encel Branch, explosives----- | 30 |
| ico. | | pilot raise, diagram----- | 13 |
| American shaft. <i>See</i> Ecuador, South | | raising shafts, description----- | 14 |
| American Development | | shaft rounds----- | 27 |
| Co. | | diagram----- | 27 |
| American Zinc Co. <i>See</i> Tennessee. | | United Verde Copper Co., United | |
| Andesite, sinking costs, direct, table----- | 93 | Verde mine, concret- | |
| sinking practice, table----- | 1 | ing----- | 66, 67, 74, 80 |
| Argonaut Consolidated Mining Co. | | costs----- | 103 |
| <i>See</i> California. | | diagram----- | 80 |
| Argonaut mine. <i>See</i> California, Ar- | | guides----- | 83, 85 |
| gonaut Consolidated | | diagram----- | 85 |
| Mining Co. | | raising shaft, description----- | 13 |
| Arizona, Bisbee Queen Mining Co., | | shaft cross section, diagram----- | 2 |
| Bisbee Queen mine, | 101 | hoist----- | 5 |
| sinking costs----- | | rounds----- | 25 |
| sinking practice, table----- | 1 | diagram----- | 25 |
| Calumet and Arizona Mining Co., | | sinking costs, table----- | 93 |
| Calumet and Arizona | | sinking practice, rate----- | 94 |
| mine, concreting----- | 70 | table----- | 1 |
| costs----- | 103 | skip----- | 43 |
| diagram----- | 70 | diagram----- | 44 |
| guides----- | 84 | timbering----- | 54 |
| manifold for drills----- | 23, 24 | diagram----- | 44 |
| sinking bucket, diagram----- | 35 | United Verde Extension Mining | |
| sinking costs, table----- | 93 | Co., Vulture mine, | |
| sinking practice, crews----- | 19 | bucket-dumping device----- | 35 |
| table----- | 1 | concreting, costs----- | 103 |
| timbering----- | 51, 52 | drilling, steel----- | 21 |
| Campbell mine, concrete lin- | | shaft rounds----- | 24 |
| ing----- | 67, 70, 72, 74 | sinking costs, tables----- | 93, 99 |
| diagram----- | 71 | sinking practice, table----- | 1 |
| cross section of shaft----- | 2 | Banks, Leon M., work cited----- | 98 |
| excavating, costs----- | 10 | Basalt, sinking costs, direct, table----- | 93 |
| guides----- | 83 | sinking practice, table----- | 1 |
| diagram----- | 84 | Bawdwin shaft. <i>See</i> India, Burma. | |
| hoists, for deep sinking----- | 5 | Bearing sets, timber used----- | 57 |
| pumping water from shaft----- | 46 | Bisbee Queen mine. <i>See</i> Arizona, | |
| Christmas Copper Co., Christmas | | Bisbee Queen Mining | |
| mine, hoists----- | 6 | Co. | |
| pumps, abrasion, by grit----- | 46 | Bisbee Queen Mining Co. <i>See</i> Ari- | |
| sinking costs, table----- | 93 | zona. | |
| sinking practice, table----- | 1 | Black, W. S., work cited----- | 93, 99 |
| ventilation----- | 48 | Black Rock mine. <i>See</i> Montana, | |
| Globe, Old Dominion mine, exca- | | Butte. | |
| vating practice----- | 9 | Blasting, procedure----- | 30 |
| Inspiration Consolidated Copper | | Blasting sets, use----- | 52 |
| Co., Inspiration mine, | | Bonuses, for labor, discussion----- | 92 |
| twin shafts, for han- | | tables----- | 93 |
| dling large tonnages----- | 2 | | |

| Page | Page | | |
|---|------------|---|-----------------------|
| Borehole, dropping broken rock----- | 45 | Canada, Teck-Hughes Gold Mines | |
| Breccia, sinking costs, direct, table-- | 93 | (Ltd.), Teck-Hughes | |
| sinking practice, table----- | 1 | mine, guides----- | 83 |
| Brier Hill shaft. <i>See</i> Michigan. | | sinking costs, tables----- | 93, 97 |
| Brock, A. F., work cited----- | 2, 19 | sinking practice, rate----- | 94 |
| Brosky, A. F., work cited----- | 77 | table----- | 1 |
| Buckets, description----- | 35 | timbering----- | 55 |
| diagram----- | 35 | diagram----- | 55 |
| loading, precautions----- | 24 | Cananea Consolidated Copper Co. | |
| with mechanical scrapers----- | 44 | <i>See</i> Mexico. | |
| shoveling into----- | 34 | Cananea mine. <i>See</i> Mexico, Cananea | |
| Bucket-dumping devices, description-- | 35 | Consolidated Copper Co. | |
| diagrams----- | 36, 37, 38 | Carper, A. F., work cited----- | 93 |
| Bulkheads, as safety measure----- | 53 | Catron, William, work cited----- | 40, 93, 99 |
| diagram----- | 53 | Champion mine. <i>See</i> Michigan. | |
| Bunker Hill & Sullivan mine. <i>See</i> | | Chief Consolidated Mining Co. <i>See</i> | |
| Idaho, Bunker Hill & Sullivan Mining & Concentrating Co. | | Utah. | |
| Bunker Hill & Sullivan Mining & Concentrating Co. <i>See</i> Idaho. | | Christmas Copper Co. <i>See</i> Arizona. | |
| Burra-Burra mine. <i>See</i> Tennessee, Tennessee Copper Co. | | Christmas mine. <i>See</i> Arizona, Christmas Copper Co. | |
| Butte. <i>See</i> Montana. | | Clark, S. S., work cited----- | 93 |
| Butte & Superior Copper Co. <i>See</i> Montana. | | Colorado mine. <i>See</i> Mexico, Cananea Consolidated Copper Co. | |
| Butte & Superior Mine. <i>See</i> Montana, Butte & Superior Copper Co. | | Colorado, Ajax Gold Mining Co., Ajax mine, sinking costs, tables----- | 93, 99 |
| Cables, diameter----- | 6 | Stratton Cripple Creek Mining & Development Co., Stratton mine, sinking costs, table----- | 93 |
| use----- | 6 | sinking practice, table----- | 1 |
| Cages, for shaft sinking, diagram----- | 41 | Tonopah-Ajax Mining Co., Ajax mine, sinking practice, rate----- | 93 |
| use----- | 41 | routine----- | 20 |
| Calhoun, A. B., work cited----- | 101 | table----- | 1 |
| California, Argonaut Consolidated Mining Co., Argonaut mine, sinking costs----- | 99 | Compania Minera de Penoles. <i>See</i> Mexico. | |
| sinking practice, table----- | 1 | Cia. Real del Monte y Pachuca. <i>See</i> Mexico. | |
| timbering----- | 49, 56 | Concrete, bearers to prevent settling-- | 77 |
| diagram----- | 56 | costs----- | 102 |
| California-Rand Silver (Inc.), California-Rand mine, sinking costs----- | 93 | table----- | 103 |
| sinking practice, table----- | 1 | curing----- | 69 |
| Engels Copper Mining Co., Engels mine, bucket-dumping device----- | 36 | delivery to forms----- | 68 |
| diagram----- | 37 | forms used----- | 69 |
| lighting----- | 48 | diagram----- | 70, 71 |
| sinking practice, table----- | 1 | mixing----- | 66 |
| timbering----- | 52, 57 | packing----- | 69 |
| North Star mine, auxiliary pans-- | 41 | placing, methods----- | 74 |
| diagram----- | 42 | diagram----- | 75 |
| hoisting, in skips----- | 42 | reinforcement----- | 73 |
| diagram----- | 43 | diagram----- | 73 |
| Vallecito mine, sinking costs----- | 102 | ring method----- | 80 |
| California-Rand mine. <i>See</i> California-Rand Silver (Inc.). | | diagram----- | 80 |
| California-Rand Silver (Inc.). <i>See</i> California. | | with steel sets, use----- | 79 |
| Calumet and Arizona mine. <i>See</i> Arizona, Calumet and Arizona Mining Co. | | diagram----- | 79 |
| Calumet and Arizona Mining Co. <i>See</i> Arizona; New Mexico. | | Concrete cribbing, precast, use----- | 81 |
| Campbell mine. <i>See</i> Arizona, Calumet and Arizona Mining Co. | | diagram----- | 82 |
| Canada, International Nickel Co., Frood mine, primers----- | 32 | Concrete linings, method----- | 66 |
| shaft, depth----- | 5 | Concrete sets, precast, use----- | 81 |
| dimensions----- | 2 | Consolidated Coppermines. <i>See</i> Nevada. | |
| rounds----- | 27 | Consolidated Cortez mine. <i>See</i> Nevada, Consolidated Cortez Silver Mines Co. | |
| diagram----- | 28 | Consolidated Cortez Silver Mines Co. <i>See</i> Nevada. | |
| sinking practice, crews----- | 19, 20 | Copper Range Co. <i>See</i> Michigan. | |
| rate----- | 94 | Costs, excavating, tables----- | 1, 10, 11, 12, 15, 93 |
| table----- | 1 | Crossheads, safety----- | 7 |
| skips----- | 38 | diagram----- | 7 |
| diagram----- | 39 | Cross section, shaft, determination-- | 1 |
| McIntyre Porcupine Mines (Ltd.), McIntyre mine, sinking practice, tables----- | 1, 95 | large----- | 2 |
| | | diagram----- | 2 |
| | | Cuba, Matahambre Mining Co., Matahambre mine, sinking practice, table----- | 1 |
| | | Cummings, A. M., work cited----- | 98 |
| | | Dacite, sinking costs, direct, table-- | 93 |
| | | sinking practice, table----- | 1 |
| | | Detroit Salt Co. <i>See</i> Michigan. | |
| | | Diabase, sinking costs, direct, table-- | 93 |

| | Page |
|---|----------|
| Diorite, sinking costs, direct, table | 93 |
| sinking practice, table | 1 |
| Dolomite, sinking practice, table | 1 |
| Drilling, description | 21 |
| Drill steel, discussion | 21 |
| Drills, types in use | 21 |
| Drullard, Howard R., work cited | 40 |
| Ecuador, South America Development Co., American shaft, concrete lining diagram | 81 82 |
| Eighty-Five mines. <i>See</i> New Mexico, Calumet and Arizona Mining Co. | |
| Elm Orlu mine. <i>See</i> Montana, Elm Orlu Mining Co. | |
| Elm Orlu Mining Co. <i>See</i> Montana. | |
| Engels Copper Mining Co. <i>See</i> California. | |
| Engels mine. <i>See</i> California, Engels Copper Mining Co. | |
| Errington mine. <i>See</i> Nevada, Treadwell Yukon (Ltd.). | |
| Eureka shaft. <i>See</i> Michigan, Ramsay. | |
| Explosives, amount per foot | 34 |
| selection | 30 |
| Federal Mining & Smelting Co. <i>See</i> Idaho; Kansas. | |
| Finlay, J. S., work cited | 58 |
| Fitch, Walter, Jr., Co. <i>See</i> Utah. | |
| Footo, A. B., work cited | 42 |
| Foreman, Charles H., work cited | 12 |
| Forms, aligning | 72 |
| steel, for concrete | 70 |
| diagram | 71 |
| wooden, for concrete | 69 |
| diagram | 70 |
| Foss, A. L., work cited | 61 |
| Fresnillo Co. <i>See</i> Mexico. | |
| Frood mine. <i>See</i> Canada, International Nickel Co. | |
| Ganghart, Marcus D., work cited | 81 |
| Gardner, E. D., work cited | 65 |
| German, W. J., work cited | 45 |
| Gillespie, R. H., work cited | 66 |
| Globe. <i>See</i> Arizona. | |
| Gogebic iron range. <i>See</i> Michigan. | |
| Goldfield Deep Mines shaft. <i>See</i> Nevada, Goldfield district. | |
| Goldfield district. <i>See</i> Nevada. | |
| Grand Central mine. <i>See</i> Utah, Chief Consolidated Mining Co. | |
| Granite, sinking costs, direct, table | 93 |
| sinking practice, table | 1 |
| Graywacke, sinking practice, table | 1 |
| Greenstone, sinking costs, direct, table | 93 |
| sinking practice | 1 |
| Ground, running, sinking through | 86 |
| Grouting, methods | 88 |
| diagram | 91 |
| Grout pipes, size | 89 |
| Guadalupe shaft. <i>See</i> Mexico, Mochtezuma Copper Co., Pillares mine. | |
| Guides, bolt sockets for attaching, diagrams | 84, 85 |
| on end plates and dividers, use | 82 |
| Gunite, for treating swelling ground | 65 |
| Harrington, George B., work cited | 87 |
| Headframes, purpose | 8 |
| Hecla mine. <i>See</i> Idaho, Hecla Mining Co. | |
| Hecla Mining Co. <i>See</i> Idaho. | |
| Heizer, Ott F., work cited | 38, 98 |
| Henry, R. J., work cited | 93 |
| Herbert, C. A., work cited | 4 |
| Hezzelwood, George W., work cited | 39 |
| Hoists, auxiliary, use | 42 |
| for deep shafts, description | 5 |

| | |
|--|----------------|
| Hoists, for prospecting, description | 5 |
| sinking requirements | 4 |
| Holes, collaring | 22 |
| rotation | 32 |
| Homestake mine. <i>See</i> South Dakota. | |
| Hooks, closed, use | 7 |
| Hose, requirements | 23 |
| Huttl, John B., work cited | 40 |
| Idaho, Bunker Hill & Sullivan Mining & Concentrating Co., Bunker Hill & Sullivan mine, excavation costs, table | 12 34 |
| explosives per foot | 34 |
| raising shaft, data | 17 |
| sinking costs, tables | 93, 98 |
| sinking practice, table | 1 |
| Federal Mining & Smelting Co., Morning mine, concreting costs, table | 103 11 |
| excavation costs, table | 11 |
| shaft support | 49 |
| shoveling into auxiliary skips | 41 |
| sinking costs, table | 93 |
| sinking practice, table | 1 |
| timbering | 54, 58 |
| Page mine, sinking costs, table | 93 |
| sinking practice, table | 1 |
| Hecla Mining Co., Hecla mine, raising shafts, description | 12 26 26 |
| shaft rounds | 26 |
| diagram | 26 |
| sinking costs, table | 93 |
| sinking practice, table | 1 |
| timbering | 49 |
| sand filling | 59 |
| Illinois, New Orient coal mine, guides | 82 |
| sinking in running ground, open-caisson method | 87 |
| Rosiclare, fluorspar mine, sinking practice, table | 1 |
| Inclined shafts, advantages | 4 |
| India, Burma, Bawdwin shaft, sinking costs | 101 |
| Ingalls, W. R., work cited | 6 |
| Injector, compressed air, for ventilating raises | 14 14 |
| diagram | 14 |
| Inspiration Consolidated Copper Co. <i>See</i> Arizona. | |
| Inspiration mine. <i>See</i> Arizona, Inspiration Consolidated Copper Co. | |
| International mine. <i>See</i> Utah, International Smelting Co. | |
| International Nickel Co. <i>See</i> Canada. | |
| International Smelting Co. <i>See</i> Utah. | |
| Iron King mine. <i>See</i> Utah, Iron King Mining Co. | |
| Iron King Mining Co. <i>See</i> Utah. | |
| Jacket set, for moving ground, description | 58 |
| diagram | 58 |
| Johnson, J. Fred, work cited | 41 |
| Kansas, Federal Mining & Smelting Co., Quapaw lease, sinking costs, table | 98 1 |
| sinking practice, table | 98 |
| Kee, H. A., work cited | 98 |
| Keener, Oliver W., work cited | 98 |
| Keiser, H. D., work cited | 89 |
| Kruse, H. V., acknowledgment | 85 |
| Kudlich, R. H., work cited | 7 |
| Lagging, keyboard, placing, diagram | 51 |
| Lamps, carbide, use in illumination | 48 |
| Leland, Everard, work cited | 15, 41 |
| Lighting, with carbide lamps | 48 |
| Limestone, sinking costs, direct, table | 93 |

| | Page | | Page |
|--|------------|--|------------|
| Limestone, sinking practice, table----- | 1 | Montana, Butte, octagonal shafts-- | 3 |
| Line oilers, uses----- | 24 | pans, auxiliary, details----- | 41 |
| Livingston, A., work cited----- | 102 | Butte & Superior Copper Co., | |
| Magma Copper Co. <i>See</i> Arizona. | | Butte & Superior mine, | |
| Magma mine. <i>See</i> Arizona, Magma | | sinking practices, table----- | 1 |
| Copper Co. | | timbering----- | 58 |
| Magnetite, sinking practice, table----- | 1 | diagram----- | 58 |
| Manifolds, for drills----- | 22 | Elm Orlu Mining Co., Elm Orlu | |
| diagram----- | 22 | mine, sinking practices, table----- | 1 |
| Matahambre mine. <i>See</i> Cuba, Mata- | | Montreal mine. <i>See</i> Wisconsin, | |
| hambre Mining Co. | | Montreal Mining Co. | |
| Matahambre Mining Co. <i>See</i> Cuba. | | Montreal Mining Co. <i>See</i> Wiscon- | |
| McIntyre mine. <i>See</i> Canada, McIn- | | sinn. | |
| tyre Porcupine Mines (Ltd.). | | Morenci Branch. <i>See</i> Arizona, | |
| McIntyre Porcupine Mines (Ltd.). | | Phelps Dodge Corpora- | |
| <i>See</i> Canada. | | tion. | |
| McPherson shaft. <i>See</i> Tennessee, | | Morning mine. <i>See</i> Idaho, Federal | |
| Tennessee Copper Co., | | Mining & Smelting Co. | |
| Burra-Burra mine. | | Mosier, McHenry, work cited----- | 14 |
| Mendelsohn, Albert, work cited----- | 44 | Mundorf, R. F., work cited----- | 88 |
| Mesabi range mine. <i>See</i> Minnesota. | | Nelson, W. I., work cited----- | 36 |
| Metagabro, sinking costs, direct, | | Nevada, Consolidated Coppermines, | |
| table----- | 93 | Alpha shaft, concrete | |
| sinking practice, table----- | 1 | lining----- | 75 |
| Mexico, Cananea Consolidated Cop- | | Consolidated Cortez Silver Mines | |
| per Co., Cananea mine, | | Co., Consolidated Cor- | |
| headframe----- | 8 | tez mine, sinking | |
| shoveling into auxiliary skip- | 40 | practice, table----- | 1 |
| sinking costs, table----- | 93 | skip-dumping device----- | 39 |
| sinking practice, table----- | 1 | timbering----- | 54 |
| Colorado mine, sinking costs---- | 9 | Goldfield district, Goldfield Deep | |
| timbering----- | 52 | Mines shaft, guniting----- | 65 |
| Cia. Minera de Penoles, Ojuela mine, | | Nevada-Massachusetts Co. (Inc.), | |
| manifold for drills----- | 22 | Nevada-Massachusetts | |
| Cia. Real del Monte y Pachuca, | | mine, sinking costs----- | 98 |
| Santa Margarita mine, | | sinking practice, table----- | 1 |
| steel shaft sets----- | 62 | Treadwell Yukon (Ltd.), Errington | |
| diagram----- | 63 | mine, sinking costs, | |
| Fresnillo Co., sinking costs----- | 102 | tables----- | 93, 98 |
| Moctezuma Copper Co., Pilares | | Nevada-Massachusetts Co. (In c.), | |
| mine, cages----- | 41 | <i>See</i> Nevada. | |
| diagram----- | 41 | Nevada-Massachusetts mine. <i>See</i> | |
| compressed-air injector, for | | Nevada-Massachusetts | |
| ventilating raises----- | 15 | Co. (Inc.). | |
| diagram----- | 14 | New Mexico, American Metal Co., | |
| deepening shafts----- | 15 | Pecos mine, bucket- | |
| hoists, auxiliary----- | 42 | dumping device----- | 38 |
| pans, auxiliary, details----- | 41 | lighting----- | 48 |
| shaft rounds, diagram----- | 26 | pumping----- | 46 |
| shoveling into auxiliary | | shaft rounds----- | 26 |
| skips----- | 40 | sinking costs, table----- | 93 |
| Pachuca district, steel sets, for | | sinking practice, table----- | 1 |
| timbering----- | 60 | water rings----- | 47 |
| Miami Copper Co. <i>See</i> Arizona. | | Calumet and Arizona Mining Co., | |
| Miami mine. <i>See</i> Arizona, Miami | | Eighty-Five mines, sink- | |
| Copper Co. | | ing costs, table----- | 93 |
| Michigan, Brier Hill shaft, concrete | | sinking practice, table----- | 1 |
| lining----- | 78 | timbering----- | 51, 52 |
| Champion mine, loading buckets | | diagram----- | 51 |
| with mechanical | | New Orient coal mine. <i>See</i> Illinois. | |
| scrapers----- | 44 | New York, Witherbee, Sherman & | |
| Copper Range Co., removal of | | Co., Mineville mine, | |
| broken rock----- | 34 | sinking costs----- | 98 |
| Detroit Salt Co., soft ground, con- | | sinking practice, table----- | 1 |
| creting----- | 77 | Nixon, W. G. C., work cited----- | 19, 28, 99 |
| water, sealing----- | 89 | North Lilly shaft. <i>See</i> Utah. | |
| Gogebic iron range, Eureka shaft, | | North Star mine. <i>See</i> California. | |
| safety crosshead----- | 8 | No. 2 mine. <i>See</i> Tennessee, Ameri- | |
| diagram----- | 7 | can Zinc Co. | |
| steel shaft sets----- | 61 | No. 8 mine. <i>See</i> Missouri, St. Louis | |
| Mills, C. E., work cited----- | 74, 80, 83 | Smelting & Refining Co. | |
| Mineville mine. <i>See</i> New York, | | Ojuela mine. <i>See</i> Mexico, Cia. Mi- | |
| Witherbee, Sherman & | | nera de Penoles. | |
| Co. | | Old Dominion mine. <i>See</i> Arizona, | |
| Minnesota, Mesabi range mine, sink- | | Globe. | |
| ing practice, table----- | 1 | Ontario. <i>See</i> Canada. | |
| Missouri, St. Louis Smelting & Re- | | Open-caisson method, discussion---- | 87 |
| finery Co., No. 8 mine, | | Pachuca district. <i>See</i> Mexico. | |
| sinking practice, table----- | 1 | Page mine. <i>See</i> Idaho, Federal Min- | |
| Moctezuma Copper Co. <i>See</i> Mexico. | | ing & Smelting Co. | |
| Montana, Butte, Black Rock mine, | | Pans, auxiliary, advantages----- | 43 |
| timbering----- | 55 | cages, for use----- | 41 |
| diagram----- | 56 | diagram----- | 41 |
| explosives----- | 30 | | |

| | Page |
|---|----------------|
| Pans, auxiliary, details----- | 41 |
| use----- | 40 |
| Parker, D. J., work cited----- | 65 |
| Park Konold mine. <i>See</i> Utah. | |
| Park Utah mine. <i>See</i> Utah. | |
| Parsons, Arthur B., work cited---- | 75 |
| Peach, A. B., work----- | 35 |
| Pecos mine. <i>See</i> New Mexico, American Metal Co. | |
| Pentices, use----- | 54 |
| Phelps Dodge Corporation. <i>See</i> Ari- zona. | |
| Pilares mine. <i>See</i> Mexico, Mocte- zuma Copper Co. | |
| Piling methods, discussion----- | 87 |
| Pilot raise, diagram----- | 13 |
| Pipe lines, holders----- | 77 |
| Pneumatic-caisson method, discus- sion----- | 88 |
| Porphyry, sinking costs, direct, table-- sinking practice, table----- | 93 1 |
| Portland Cement Association, con- crete specifications----- | 66 |
| Primers, use----- | 31 |
| Pumps, for removing water----- | 46 |
| Pyne shaft. <i>See</i> Alabama, Wood- ward Iron Co. | |
| Pyramid cuts, for small shafts----- | 25 |
| Quapaw lease. <i>See</i> Kansas, Federal Mining & Smelting Co. | |
| Quartz, sinking costs, direct----- | 93 |
| sinking practice, table----- | 1 |
| Quartzite, sinking costs, direct, table-- | 93 |
| sinking practice, table----- | 1 |
| Raises, ventilation----- | 14 |
| diagram----- | 14 |
| Raising shafts, costs----- | 15, 16, 17, 18 |
| methods----- | 12 |
| Ramsay. <i>See</i> Michigan, Gogebic iron range, Eureka shaft. | |
| Rand. <i>See</i> South Africa. | |
| Randfontein shaft. <i>See</i> South Af- rica, Rand. | |
| Rectangular shafts, preference----- | 3 |
| Rhyolite, sinking costs, direct, table-- | 93 |
| sinking practice, table----- | 1 |
| Ring method, of concreting shafts-- diagram----- | 80 80 |
| Rock, broken, removal----- | 34 |
| in place, sinking through----- | 86 |
| Rock Springs mines Nos. 4 and 5. <i>See</i> Wyoming, Union Pacific Coal Co. | |
| Rosiclare, fluorspar mine. <i>See</i> Illi- nois. | |
| Rounds, wiring----- | 32 |
| Round shafts, in water measures-- diagram----- | 3 3 |
| Saginaw shaft. <i>See</i> Arizona, Calu- met and Arizona Min- ing Co., Calumet and Arizona mine. | |
| St. Louis Smelting & Refinery Co. <i>See</i> Missouri. | |
| Sand filling, for swelling ground-- | 59 |
| Sandstone, sinking costs, direct, table----- | 93 |
| sinking practice, table----- | 1 |
| Santa Margarita mine. <i>See</i> Mexico, Cia. Real del Monte y Pachuca. | |
| Schist, sinking costs, direct, table-- | 93 |
| sinking practice, table----- | 1 |
| Scrapers, mechanical, for loading buckets----- | 44 |
| Sedimentaries, sinking costs, direct, table----- | 93 |
| sinking practice, table----- | 1 |
| surface, sinking through----- | 86 |
| Sericite, sinking costs, direct, table-- | 93 |
| Sevier Valley Coal Co. <i>See</i> Utah. | |

| | Page |
|---|------------------------|
| Sevier Valley mine. <i>See</i> Utah, Se- vier Valley Coal Co. | |
| Shaft rounds, adapting to locality-- | 24 |
| Shaft sets, diagrams----- | 55, 56, 57 |
| steel, advantages----- | 60 |
| timber, treatment with preserva- tive----- | 54 |
| wood used----- | 54 |
| Shale, sinking costs, direct, table-- | 93 |
| sinking practice, table----- | 1 |
| Shape, shaft, determination----- | 1 |
| Sherman, Gerald, work cited----- | 14 |
| Shoveling, into buckets----- | 34 |
| Sinking costs, direct, table----- | 93 |
| discussion----- | 96 |
| tables----- | 97, 98 |
| Sinking practice, table----- | 1 |
| Sinking rates, tables----- | 93 |
| Sinking shafts, crews----- | 19 |
| planning----- | 18 |
| routine----- | 20 |
| Skips, auxiliary, diagram----- | 40 |
| use----- | 40 |
| hoisting, diagrams----- | 42, 43, 44 |
| discussion----- | 42 |
| in inclined shafts, diagram----- | 39 |
| use----- | 38 |
| Skip-dumping devices, description-- | 39 |
| Smoke, after blasting, removal----- | 47 |
| Snow, Fred W., work cited----- | 93 |
| South Africa, Rand, Randfontein shaft, shaft rounds, diagram----- | 29 |
| sinking costs----- | 99 |
| sinking shafts, crews----- | 19 |
| routine----- | 20 |
| South America Development Co. <i>See</i> Ecuador. | |
| South Dakota, Homestake mine, sink- ing, costs----- | 102 |
| Steel sets, advantages----- | 60 |
| combined with concrete, diagram-- | 79 |
| diagrams----- | 61, 63 |
| placing----- | 60 |
| Stoddard, Alfred C., work cited----- | 2 |
| Stovel, J. H., work cited----- | 79, 92 |
| Stratton Cripple Creek Mining & Development Co. <i>See</i> Colorado. | |
| Stratton mine. <i>See</i> Colorado, Strat- ton Cripple Creek Min- ing & Development Co. | |
| Taconite, sinking practice, table---- | 1 |
| Taylor, M., work cited----- | 90 |
| Teck-Hughes Gold Mines (Ltd.). <i>See</i> Canada. | |
| Teck-Hughes mine. <i>See</i> Canada, Teck-Hughes Gold Mines (Ltd.). | |
| Tennessee, American Zinc Co., No. 2 mine, sinking prac- tice, table----- | 1 |
| Tennessee Copper Co., Burra-Burra mine, hoists----- | 6 |
| shaft rounds----- | 28 |
| diagram----- | 28 |
| sinking costs----- | 99 |
| sinking practice, table----- | 1 |
| Tennessee Copper Co. <i>See</i> Tennes- see. | |
| Texas, salt mine, grouting ahead of sinking----- | 90 |
| diagram----- | 91 |
| Timbering, importance----- | 48 |
| in moving ground, installation-- | 57 |
| placing----- | 49 |
| diagrams----- | 19, 51, 55, 56, 57, 58 |
| Tomlinson, H., work cited----- | 93 |
| Treadwell Yukon (Ltd.). <i>See</i> Nevada. | |
| Tri-State district, multiple shafts, use----- | 3 |
| sinking costs, tables----- | 93, 98 |
| sinking practice, table----- | 1 |

| | Page | | Page |
|--|----------------|--|--------------------|
| Tri-State district, timber lining----- | 49 | Utah, Sevier Valley Coal Co., Sevier | |
| Waco shaft, sinking costs----- | 98 | Valley mine, concreting | |
| Tuff, sinking costs, table----- | 93 | costs----- | 103 |
| Union Pacific Coal Co. <i>See</i> Wyo- | | sinking costs, table----- | 93 |
| | | Utah Copper Co., timbering, dia- | |
| | | gram----- | 19 |
| Utah, Chief Consolidated Mining Co., | | Vallecito mine. <i>See</i> California. | |
| Chief Consolidated | | Vanderburg, William O., work cited-- | 30, 99 |
| mine, sinking practice, | | V cuts, for rectangular shafts----- | 24 |
| table----- | 1 | diagrams----- | 25, 26, 27, 28, 29 |
| Grand Central mine, sinking | | Ventilation, methods----- | 47 |
| costs, tables----- | 93, 98 | Vulture mine. <i>See</i> Arizona. | |
| sinking practice, bonus----- | 95 | Waco shaft. <i>See</i> Tri-State district. | |
| rate----- | 94 | Water, disposal----- | 45 |
| table----- | 1 | leakage, through concrete linings, | |
| Fitch, Walter, jr., Co., Chief Con- | | prevention----- | 77 |
| solidated mine, bucket- | | diagrams----- | 78 |
| dumping device----- | 36 | sealing from shafts----- | 88, 92 |
| diagram----- | 36 | Water Lily shaft. <i>See</i> Fitch, | |
| concrete lining----- | 67, 68, 75, 77 | Walter, jr., Co., Chief | |
| diagram----- | 75 | Consolidated mine. | |
| headframe----- | 9 | Water lines, for drills, size----- | 23 |
| sinking costs, tables----- | 93, 98 | Water rings, use----- | 47 |
| sinking shafts, bonus----- | 93 | Weaver, Lamar, work cited----- | 28, 99 |
| routine----- | 20 | Wisconsin, Montreal Mining Co., | |
| timbering----- | 52 | Montreal mine, sinking | |
| diagram----- | 53 | practice, table----- | 1 |
| International Smelting Co., Inter- | | Witherbee, Sherman & Co. <i>See</i> New | |
| national mine, sinking | | York. | |
| practice, table----- | 1 | Woodward Iron Co. <i>See</i> Alabama. | |
| Iron King Mining Co., Iron King | | Wyoming, Union Pacific Coal Co., | |
| mine, sinking practice, | | Rock Springs mines | |
| table----- | 1 | Nos. 4 and 5, timber- | |
| North Lily shaft, timbering----- | 58 | ing----- | 56 |
| Park Konold mine, auxiliary skip- | | diagram----- | 57 |
| diagram----- | 40 | Young, C. M., work cited----- | 4 |
| Park Utah mine, pumping, small | | Young, George J., work cited----- | 66 |
| amounts of water----- | 46 | Youtz, Ralph B., work cited----- | 51, 93 |