

DOE/UMTRA--350124 1

DE91 005819

PROJECT
SURVEILLANCE AND MAINTENANCE
PLAN

SEPTEMBER, 1985

U.S. Department of Energy
UMTRA Project Office
Albuquerque Operations Office
P.O. Box 5400
Albuquerque, New Mexico 87115

John G. Themelis
UMTRA Project Manager

MASTER *JGT*

DISTRIBUTION OF THIS DOCUMENT IS UNLIMITED

TABLE OF CONTENTS

<u>Section</u>	<u>Page</u>
SUMMARY	
1.0 INTRODUCTION	1
1.1 Relationship to licensing and objectives.	1
1.2 Approach.	1
1.2.1 Final site conditions	2
1.2.2 Site inspections.	3
1.2.3 Ground-water monitoring	3
1.2.4 Aerial photography.	3
1.2.5 Maintenance/contingency plans	3
1.2.6 Reporting and recordkeeping	4
1.3 Responsibilities.	4
1.4 Surveillance and maintenance process.	5
2.0 FINAL SITE CONDITIONS.	7
2.1 Introduction.	7
2.1.1 Baseline data	7
2.1.2 Surveillance features	7
2.2 Ground photographs.	8
2.2.1 Construction photographs.	8
2.2.2 Baseline photographs.	9
2.3 Baseline data maps.	9
2.3.1 Vicinity map.	9
2.3.2 Site map.	9
2.4 Aerial photos	10
2.5 Site atlas.	10
2.6 Monuments, markers, and signs	11
2.6.1 Horizontal and vertical control	11
2.6.2 Boundary monuments.	11
2.6.3 Site markers.	15
2.6.4 Signs	15
2.6.5 Survey standards.	17
2.6.6 Aerial photography.	17
2.7 Monitor wells	17
2.7.1 Well drilling and coring procedures	18
2.7.2 Monitor well installation and development	19
[2.8 Settlement plates	25]
[2.9 Additional requirements	25]
3.0 SITE INSPECTION.	27
3.1 Introduction.	27
3.2 Types of inspections.	27
3.2.1 Phase I and Phase II inspections.	27
3.2.2 Contingency inspections	27
3.3 Inspection procedures (Phase I)	29
3.3.1 Preliminary considerations.	29
3.3.2 Site inspection.	31
3.3.3 Ground photography.	37
3.4 Phase II inspections.	39
3.4.1 Relation to Phase I	39
3.4.2 Phase II procedures and objectives.	40
[3.4.3 Schedule and reporting.	41]

TABLE OF CONTENTS (Continued)

<u>Section</u>	<u>Page</u>
4.0 GROUND-WATER MONITORING.	43
4.1 [Guidelines] to determine need and extent	43
4.2 Background and baseline ground-water quality.	46
[4.3 Data acceptability and statistical procedures	55]
[4.4 Response to excursions.	59]
[4.5 Monitoring schedule and reporting	59]
5.0 AERIAL PHOTOGRAPHY	61
5.1 Introduction.	61
5.1.1 Objectives.	61
5.1.2 Comparison of aerial photography formats.	61
5.2 Flight planning and aerial photography specifications	62
5.2.1 Color infrared stereo contact prints.	62
5.2.2 Low oblique photographs	62
5.2.3 Timing of aerial photography flights.	64
5.3 Aerial photography interpretation	64
5.3.1 Use of existing photo interpretation keys	64
5.3.2 Development of photo interpretation keys.	64
5.3.3 Qualifications for photo interpreters	66
5.3.4 Identification and recordation of features.	66
6.0 CUSTODIAL MAINTENANCE AND CONTINGENCY PLANS.	69
6.1 Institutional procedures.	69
6.2 Site conditions requiring maintenance or repair	69
6.3 Maintenance and contingency repair action	69
6.4 Notification to affected parties.	69
6.5 Certification of maintenance or contingency repair.	72
7.0 REPORTING AND RECORDKEEPING.	73
7.1 Introduction.	73
[7.2 Site file	73]
[7.3 Final site conditions	74]
[7.4 Site inspection	74]
[7.4.1 Records	74]
[7.4.2 Reports	74]
[7.5 Ground-water monitoring	75]
[7.5.1 Records	75]
[7.5.2 Reports	75]
[7.6 Aerial photography.	77]
[7.6.1 Records	77]
[7.6.2 Reports	77]
[7.7 Maintenance and contingency repair.	77]
[7.7.1 Records	77]
[7.7.2 Reports	77]

TABLE OF CONTENTS (Concluded)

<u>Section</u>	<u>Page</u>
REFERENCES	79
GLOSSARY	
ACRONYMS	
Appendix A, Inspection Photo Log	A-1
Appendix B, Modifying Processes.	B-1
Appendix C, Phase I Inspection Checklist	C-1
Appendix D, Ground-Water Instructions.	D-1
Appendix E, Aerial Photography Quality Assurance	E-1

LIST OF FIGURES

<u>Figure</u>	<u>Page</u>
1.1 Surveillance and maintenance process	6
2.1 Berntsen RT-1 marker	12
2.2 Precast station monument set in soil	13
2.3 Typical above grade UMTRA site	14
2.4 Berntsen A-1 monument.	16
2.5 Typical observation well	20
2.6 Borehole/well construction log	21
2.7 Well completion record	22
[2.8 Borehole log (soil).	23]
[2.9 Borehole log (rock).	24]
[2.10 Typical settlement plate	26]
3.1 Surveillance and maintenance process	28
3.2 Typical route for site inspection.	34
4.1 Ground-water monitoring for uniform, homogeneous, isotropic conditions	45
4.2 Ground-water monitoring for highly stratified conditions	47
4.3 Ground-water monitoring for heterogeneous conditions	48
4.4 Ground-water monitoring for anisotropic conditions	49
4.5 Ground-water sampling record	51
4.6 Static ground-water level record	54
4.7 Water-quality analytical results	56
4.8 Soil/rock analytical results figure.	57
4.9 Slug test data	58

LIST OF TABLES

<u>Table</u>	<u>Page</u>
Summary Table	
4.1 Background, baseline, and compliance monitoring constituent list.	50
5.1 Aerial photography specifications.	63
5.2 Photo interpretation keys and aids	65
5.3 Comparison of feature identification (ease of detection)	67
6.1 Examples of site conditions that may require custodial maintenance	70
6.2 Examples of site conditions that may require contingency repair	70
6.3 Custodial maintenance or repair actions which could be needed at sites	71
7.1 Aerial photographic records.	78

SUMMARY

The Project Surveillance and Maintenance Plan describes the procedures that will be used by the U.S. Department of Energy (DOE), or other agency as designated by the President, to verify that [Uranium Mill Tailings Remedial Action (UMTRA) Project] disposal sites remain in compliance with the U.S. Environmental Protection Agency standards [(40 CFR Part 192)]. The UMTRA Project Office will conduct surveillance and maintenance activities until March 7, 1990. At that time, the DOE or other agency as designated by the President will maintain the sites as required by the NRC.

The approach of this plan is to specify surveillance requirements and maintenance procedures for a 10-year period following completion of remedial action at a site. The 10-year period has been selected to establish trends in changing site conditions. Based upon regularly scheduled surveillances over the 10-year period, and maintenance as necessary, the DOE (or other agency) will have a basis from which future (beyond year 10) requirements can be established.

The plan addresses five primary activities:

1. Definition and characterization of final site conditions.
2. Site inspections.
3. Ground-water monitoring.
4. Aerial photography.
5. Custodial maintenance and contingency repair.

Final site conditions will be defined and characterized prior to the completion of remedial actions at a site. As-built drawings will be compiled, a final topographic survey will be performed, a vicinity map will be prepared, and ground and aerial photographs will be taken. Survey monuments, site markers, and signs will be established as will a network of monitoring wells (if required).

Site inspections will be of three types: Phase I, Phase II, and contingency inspections. Phase I inspections will be conducted by a small team to identify conditions that may lead to non-compliance with the standards. Phase II inspections are unscheduled and are dependent upon potential problems identified during a Phase I inspection. Team members of a Phase II inspection will be specialists in the potential problem areas (e.g., soil mechanics for settlement). Contingency inspections will also be unscheduled and will occur when information has been received that indicates that site integrity has been, or may be, threatened by natural events (e.g., severe earthquake) or other means.

Monitoring of ground-water conditions may be necessary as part of the surveillance. Monitoring will be conducted in two phases, detection monitoring and compliance monitoring. Detection monitoring is designed to detect changes in ground-water quality attributable to the tailings. If a change is apparent, compliance monitoring will be initiated. Compliance monitoring will be more extensive and will quantify the rate and magnitude of the change of conditions.

Surveillances will include the acquisition and interpretation of aerial photography. The principal purposes of aerial photography are to aid inspectors in the field and to provide a permanent, visual record of site conditions. Color infrared stereo photos, high oblique prints, and low oblique, natural color photographs will be taken at the completion of remedial action and at years three and eight within the 10-year period.

Custodial maintenance such as grass mowing or fence repair will be required at some sites. Extreme natural events or purposeful intrusion may occur at a site which would require immediate repair. When compared with contingency repair, maintenance will be less costly, smaller in scale, and more frequent in occurrence. In contrast, contingency repairs are very unlikely to be needed; however, repair costs may be substantial.

The Summary Table provides an annual listing of surveillance and maintenance activities during the 10-year period.

SUMMARY TABLE

	Time (year)										
	0	1	2	3	4	5	6	7	8	9	10
Final site conditions	X										
Phase I inspections		X	X	X		X		X		X	D
Phase II inspections						As needed					
Contingency inspections						As needed					
Aerial photography									X		D
Ground-water monitoring Baseline and background Detection Compliance		X-Q	X-Q	X-Q	X-Q	As needed					D
Custodial maintenance						As needed					
Contingency repair						As needed					

X = Year of occurrence.
D = Reevaluation and decision point.
Q = Quarterly sampling.

1.0 INTRODUCTION

1.1 RELATIONSHIP TO LICENSING AND OBJECTIVES

The Project Surveillance and Maintenance Plan (PSMP) describes the procedures that will be used by the U.S. Department of Energy (DOE), or other agency as designated by the President (collectively referred to as responsible agency), to verify that inactive uranium tailings disposal facilities remain in compliance with licensing requirements and U.S. Environmental Protection Agency (EPA) standards for remedial actions (40 CFR [Part] 192).

The PSMP will be used as a guide for the development of individual Site Surveillance and Maintenance Plans (part of a license application) for each of the UMTRA Project sites. The PSMP is not intended to provide minimum requirements but rather to provide guidance in the selection of surveillance measures. For example, the plan acknowledges that ground-water monitoring may or may not be required and provides the [guidance] to make this decision.

The Site Surveillance and Maintenance Plans (SSMPs) will form the basis for the licensing of the long-term surveillance and maintenance of each UMTRA Project site by the NRC. Therefore, the PSMP is a key milestone in the licensing process of all UMTRA Project sites. The Project Licensing Plan (DOE, 1984a) describes the licensing process.

1.2 APPROACH

The approach as put forth in this [Plan] is to specify surveillance and maintenance requirements for 10 years following remedial action in order to establish a trend in changing conditions at a site. The recording of site conditions on a regular basis for several years following remedial action will form the basis for the NRC and the DOE (or other agency) to modify surveillance and maintenance requirements to ensure continued long-term compliance with the EPA standards. This approach recognizes the difficulty in predicting the necessary surveillance and maintenance requirements beyond the next several years.

It is recognized that the procedures and guidelines in this plan [will] require modification after the 10-year interval because of other phenomena that may influence the sites. For example, chemical and physical weathering of rock covers, [or other geological processes,] would be observable only over the very long term.

Based upon this approach, the PSMP addresses five primary activities that the DOE or other agency may conduct following completion of remedial action at all UMTRA Project sites:

1. Definition and characterization of final site conditions.
2. Site inspections.
3. Ground-water monitoring.
4. Aerial photography.
5. Custodial maintenance and contingency repair activities.

The details and procedures of these activities as described in this Plan must be viewed within the context of the design standard; that is, remedial actions must be designed to last for 200 to 1000 years. The Plan for Implementing EPA Standards for UMTRA Sites (DOE, 1984b) states:

"In establishing the longevity requirement, EPA concluded that existing knowledge permits the design of control systems that have a good expectation of lasting at least 1000 years. Therefore, a design objective of 1000 years was established to be satisfied whenever reasonably achievable, but in any case with a minimum performance period of 200 years."

However,

"The standards recognize the need for institutional controls such as custodial maintenance, monitoring, and contingency response measures."

1.2.1 Final site conditions

Prior to completion of remedial action at an UMTRA Project site, the final site conditions will be defined and characterized as the first step in the surveillance and maintenance process. After completion of the remedial action, information will be assembled into a "site file" that will be reviewed by the responsible agency prior to surveillance activities. The features of the final site conditions that are necessary for surveillance are described in detail in Section 2.0 of this [Plan].

Generally, documents and materials used to characterize final site conditions will include:

- o As-built engineering drawings.
- o Topographic maps and surveys.
- o Vicinity maps.
- o Photographs (both on the ground and aerial).
- o Records and surveys of monuments and site markers.
- o Ground-water monitor well records including water-quality data.

[o Results of construction audits.]

The extent of information regarding final conditions in the site file will be dependent upon the conditions at each site. For example, an irregularly shaped above-grade pile will require more monuments and site markers than a buried pile; multiple, nested monitor wells (and baseline data) will be required to monitor complex hydrologic conditions (e.g., potable aquifer, anisotropic conditions) at some sites whereas no wells may be required at other sites.

1.2.2 Site inspections

For the site inspection phase of surveillance, a team of inspectors will be assembled to conduct on-the-ground examinations of the disposal sites and facilities, and surrounding areas. Three types of inspections are considered:

1. Phase I inspections.
2. Phase II inspections.
3. Contingency inspections.

Phase I inspections will be conducted during years 1, 2, 3, 5, 7, and 9 by a small team of qualified inspectors to identify conditions that could lead, if left unattended, to damage to the tailings cover, diversion ditches, or other design features. Phase II inspections would be a follow-up visit, if appropriate, to a site to further investigate and quantify particular conditions that were observed during a Phase I inspection. Contingency inspections would be unscheduled, and would be conducted at the request of the NRC or responsible agency when information is received from other agencies (e.g., National Oceanic and Atmospheric Administration (NOAA)) that indicates that site integrity has been or may be threatened by natural events (e.g., severe earthquake) or other means. Site inspections are explained in detail in Section 3.0.

1.2.3 Ground-water monitoring

At some UMTRA Project sites, monitoring of ground-water conditions may be necessary as part of the surveillance activities. Monitoring will be conducted in two phases: detection monitoring and compliance monitoring. Detection monitoring will detect changes in ground-water conditions attributable to the tailings pile after remedial action. If such a change is detected, compliance monitoring will be undertaken to further quantify the rate and magnitude of this change. The ground-water monitoring program is described in Section 4.0.

1.2.4 Aerial photography

Surveillance will also include the acquisition and interpretation of aerial photography to aid site inspectors and to provide a permanent record of site conditions. Comparison of photographs taken over several years will provide a means to measure changes in site conditions which could affect site integrity. The use of aerial photography in site surveillance is discussed in Section 5.0.

1.2.5 Maintenance/contingency plans

Custodial maintenance such as mowing of the grass cover in "wet" climates or repair of the damaged perimeter fence is

expected to be required at the sites. Extreme natural events, intentional intrusion, or other events may occur at a site which would require contingency repair to ensure that the tailings facility continues to function as intended. Site-specific contingency plans will be developed as part of a license application.

Custodial maintenance and contingency repair plans are explained in Section 6.0.

1.2.6 Reporting and recordkeeping

Information in the form of an inspection checklist with appended field notes, ground and aerial photographs, water-quality analyses, field measurements, field notations on base maps, and the resulting reports will be compiled in a site file. The site file will be compiled and retained by the responsible agency for review by the NRC.

Details of the reporting and recordkeeping requirements are discussed in Section 7.0.

1.3 RESPONSIBILITIES

The following defines the various major responsibilities of the responsible agency (DOE or other agency as designated by the President) and the NRC to satisfy the requirements of this surveillance and maintenance plan. The UMTRA Project Office will conduct the surveillance and maintenance program until termination of the UMTRA Project, which under the enabling legislation is to be March 7, 1990. At that time, the DOE, or another agency to be designated by the President, will maintain the sites as required by the NRC. Between the present date and March 7, 1990, the DOE will be assisted by the Technical Assistance Contractor (TAC) and the Remedial Action Contractor(s) (RAC, state, or private contractor).

Responsibilities pursuant to the surveillance and maintenance process can be summarized as follows:

DOE (including TAC, RAC) or other designated agency:

- o Prepare site-specific license application (including surveillance and maintenance plan).
- o Design and construct final site conditions.
- o Perform site inspections.
- o Conduct ground-water monitoring program.
- o Perform aerial photography.
- o Perform custodial maintenance and contingency repairs.
- o Maintain records [and reports].

c Certify maintenance or contingency repair.

NRC

o Issue license (includes surveillance and maintenance requirements).

o Review responsible agency reports.

1.4 SURVEILLANCE AND MAINTENANCE PROCESS

Although the various primary aspects of this plan (i.e., site inspection, aerial photography, ground-water monitoring) are discussed as separate components, it is the duty of the responsible agency to ensure complete integration of each component. The responsible agency will coordinate component activities, and will consider the results of each report from the various component activities prior to a determination of need for [a] Phase II inspection, compliance monitoring, additional aerial photography, maintenance, or contingency repair. This process (i.e., intraprogram coordination) is depicted in Figure 1.1.

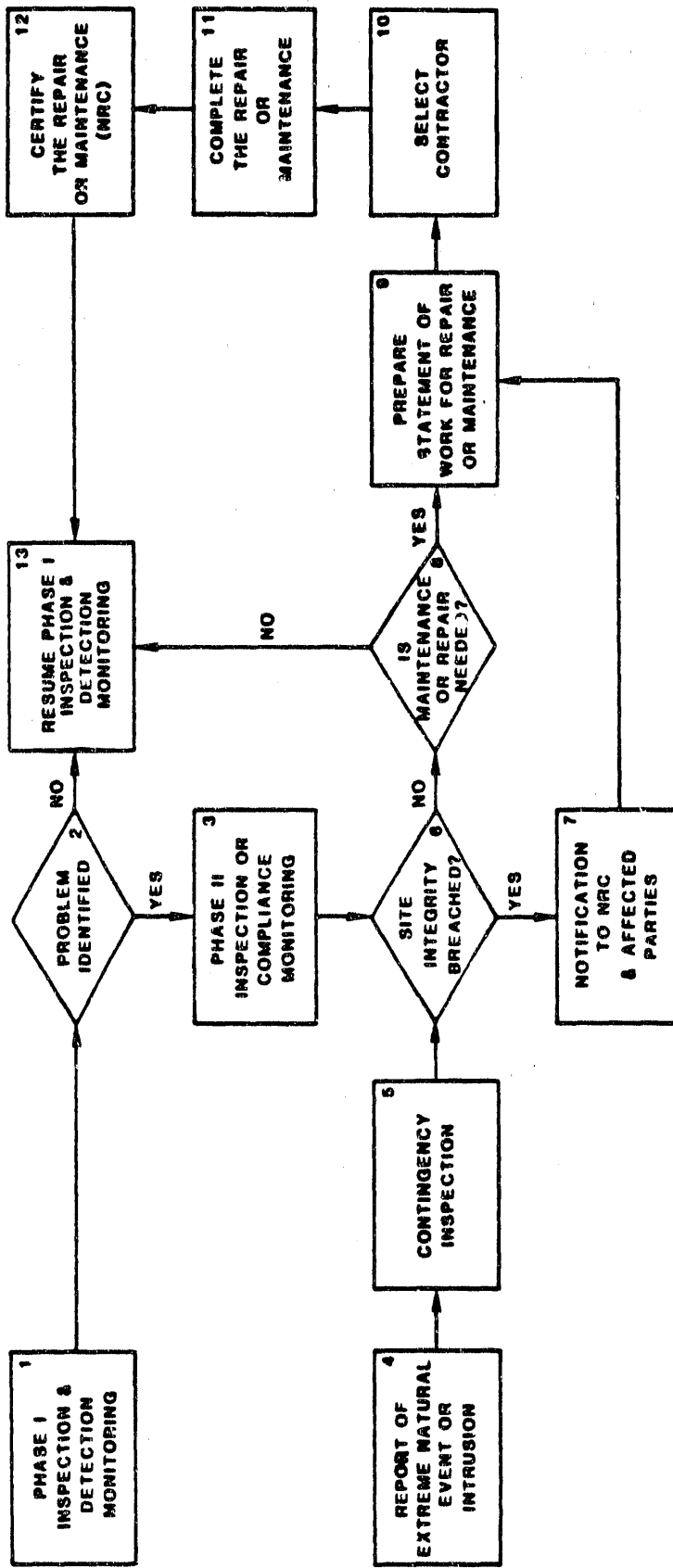

**FIGURE 1.1
SURVEILLANCE AND MAINTENANCE PROCESS**

2.0 FINAL SITE CONDITIONS

2.1 INTRODUCTION

This chapter describes the methods for defining and establishing final site conditions required for the conduct of post-remedial action surveillance (includes monitoring) and maintenance. Final site conditions consist of baseline data and [surveillance] features, ground and aerial photographs, baseline data maps, site atlas, monuments, markers and signs, monitor wells[, settlement plates, and other additional instrumentation.] This information will be part of a site file [(see Section 7.2).]

2.1.1 Baseline data

Baseline data constitute documents that describe the as-built site from a surveillance and maintenance perspective. These documents will describe the baseline conditions against which surveillance and maintenance results will be compared. Baseline data documents include:

- o As-built drawings.
- o Ground photographs (see Section 2.2).
- o Site baseline data maps (i.e., site vicinity map and final topographic survey) (see Section 2.3).
- o Site aerial photographs (see Section 2.4).
- o Site atlas which consists of the final topographic survey (i.e., base map) and a set of overlays (see Section 2.5).

2.1.2 Surveillance features

Surveillance features are features built into the site to facilitate surveillance and maintenance. Surveillance features include:

- o Monuments, site markers, and signs (see Section 2.6).
- o Ground-water monitor wells (see Section 2.7).

[o Settlement plates (see Section 2.8).]

Other features that may be necessary at specific sites will be determined as part of a specific license application site surveillance and maintenance plan. Such features may include, but are not limited to, gauging stations to monitor streamflow, erosion pins and chains, and bank wear rods [(see Section 2.9).]

2.2 GROUND PHOTOGRAPHS

Two sets of ground photographs will be included in the baseline data package; construction photographs and baseline photographs. Both sets of photographs will be incorporated in[to] the site file. The original prints and negatives for each set will be preserved in accordance with current archival procedures and maintained in the archives of the responsible agency.

2.2.1 Construction photographs

Construction photographs constitute a series of photographs taken during the remedial action to illustrate implementation of the final design and site construction methods. These photographs will be useful in familiarizing the site inspectors with construction details and characteristics. The number of photographs taken during construction will be dependent on the complexity of the design under construction. At a minimum, construction photographs will include:

- o Photos taken of the site prior to initiation of remedial action. Photos will be taken from observation points that will be undisturbed, or minimally disturbed, by the remedial action.
- o Photos of temporary construction structures or features such as vehicle washdown pads, diversion dikes, or evaporation ponds while in service and of the same areas immediately after the structures or features are removed.
- o Photos of excavated areas prior to the emplacement of tailings materials in the excavation.
- o Photos of razed structural material emplaced in the excavation along with the tailings.
- o Photos of the site after tailings are emplaced in the excavation, but before any cover layers are established.
- o Photos of the site after each layer of cover material is constructed.

If the remedial action is such that an area of a site is completed while other areas are in earlier phases of remedial action, representative photos will be taken of each area.

Construction photographs will be taken with equipment described in Section 3.3.3a. A Photo Log Form (Appendix A) will be completed for all photographs. The observation point from which each photo was taken will be recorded on a plan view drawing dedicated to recording such information. More than one plan view will be used if a particular position is used repeatedly during the remedial action.

2.2.2 Baseline photographs

Baseline photographs will be a full and complete set of ground photographs taken upon the completion of remedial action. The observation point from which each photo was taken will be recorded on a plan view drawing; this drawing will become an as-built, which in turn will become an overlay to the base map (see Section 2.5). Photo equipment, procedures, and point selection criteria are provided in Section 3.3.3.

2.3 BASELINE DATA MAPS

The baseline data maps for each site will include a vicinity map and a detailed site map. These maps will be used during site inspections.

2.3.1 Vicinity map

The vicinity map will include an area extending a minimum of three miles in all directions from a disposal site. The base for the vicinity map will be a USGS 1:24,000 topographic quadrangle sheet(s). If USGS quadrangles are not available, the best available alternate will be obtained. Information to be shown on the vicinity map will include community boundaries, land subdivision, longitude and latitude, state plane coordinates, topography, drainage, works of man such as roads and buildings, nearby wells and boreholes, and land ownership (land ownership includes only broad categories such as private, Indian, military, and Forest Service). If the data cannot be illustrated on a single map, transparent overlays to the vicinity map will be used to depict various features.

Descriptive information will be appended to the vicinity map for inclusion in the site file. Information includes year of map compilation, use of nearby wells and boreholes, well and borehole logs (if available), well depths, producing intervals, yields and uses, [geologic units, fracture and fault descriptions, and geomorphic features descriptions.]

2.3.2 Site map

The site map will be based on a topographic survey of the final site after the completion of the remedial action. The topographic survey and the resulting site map will meet the following specifications:

- o The scale will not be less than 1:[200].
- o The contour interval will be two feet.
- o The survey will be done to the standards of the Manual of Photogrammetry, 4th Edition (ASP, 1980).

In addition to topography, the site map will show property boundaries, fences, roads, access paths, monitor wells, surveying control stations, monuments, markers, [settlement plates, and other surveillance features.] The coordinates in degrees, minutes, and seconds for each feature, or selected points of a feature such as a fence or road, will be shown on the site map or on a site map overlay.

2.4 AERIAL PHOTOS

After completion of the remedial action, a set of stereo coverage aerial photographs will be obtained. This set of photographs will provide a record of as-built conditions that will be useful as a benchmark for comparison of site conditions over time. The aerial photograph record will be particularly useful in evaluating trends in erosion, adjacent stream channel meander, vegetation encroachment, and in other site modifying processes.

The specifications for as-built aerial photographs are found in Table 5.1 and Section 5.2. Horizontal and vertical control points and targets, as discussed in Section [2.6.6,] will be in place prior to aerial photography flight.

2.5 SITE ATLAS

The site atlas, consisting of a base map and a limited set of overlays, will be developed specifically for the use of inspectors in the field. The overlays will provide locational data of significant features and will act as a form on which inspectors will record field observations. The site atlas will also contain as-built conditions and will be incorporated in the site file.

The base map for the overlays will be the final topographic map described in Section 2.3.2. Multiple overlays to the base map will be prepared, as necessary. The number of overlays will be a compromise between the objectives of having clean and uncluttered maps on which to record observations and of not burdening the inspectors with an excessive number of maps. Overlays will be prepared to include:

- o Immediately adjacent off-site features and land use, access roads and paths, fences, gates, and signs.
- o Monitor wells, diversion channels, other site drainage features.
- o Boundary monuments, survey control monuments, aerial photo ground controls, ground photo locations, and site markers.
- o Vegetation cover and preplanned inspection transects.
- o Property boundaries and the outlines of the base and crest of the embankment (if appropriate).
- o Location and extent of rock cover.

[o Immediately adjacent geomorphic features that represent dynamic processes (e.g., fault zone, river).]

o Others as appropriate.

2.6 MONUMENTS, MARKERS, AND SIGNS

2.6.1 Horizontal and vertical control

A minimum of three permanent survey monuments will be established at each site. These will be referenced to the USGS or National Geodetic Survey (NGS) control networks, and the State Plane Coordinate System. Prior to the setting of the monuments, a field reconnaissance will be conducted. Although highly precise ties to regional control stations are not necessary, horizontal and vertical control will be to at least second order standards.

Other considerations for placing of the monuments are accessibility, intervisibility between the monuments, and the ability to complete network ties to stations of the USGS or NGS. Lines of sight from each monument to the national control stations will be maintained on all sides of the site while maintaining maximum intervisibility between the monuments. The monuments will be, if at all possible, located in a visually commanding position, not likely to be disturbed by natural or human action, and convenient for surveys from all portions of the site by use of short-range distance measuring equipment.

If durable bedrock is at or near the surface, monuments will be installed by setting a standard, flared aluminum cap, 3.25 inches in diameter with a [three]-inch-long stem set in solid bedrock. The standard will be installed in a pilot hole in the rock and cemented in with "rockite" grout or equivalent (Figure 2.1).

In the absence of solid bedrock in appropriate locations for such an installation, an alternative procedure will be to set a precast concrete or granite-type monument. The form of the monument will be a truncated cone or pyramid (frustum) with a standard metal cap cast into its top. The monument will contain a reinforcing bar or a magnet to allow for discovery with a metal detector. A typical monument will have a diameter of six inches at the top, 12 inches high, and have a diameter of eight inches at the base. The monument will be set in concrete which has been poured into a hole that extends at least 18 inches below the frost line. The monument will be set so that about one-fourth is above the ground surface (Figure 2.2). The diameter of the hole will be at least twice the largest diameter of the monument.

2.6.2 Boundary monuments

Boundary monuments will be set at all corners on the legal boundaries of a rectilinear site (Figure 2.3). If the site is irregularly shaped, sufficient boundary monuments will be set as

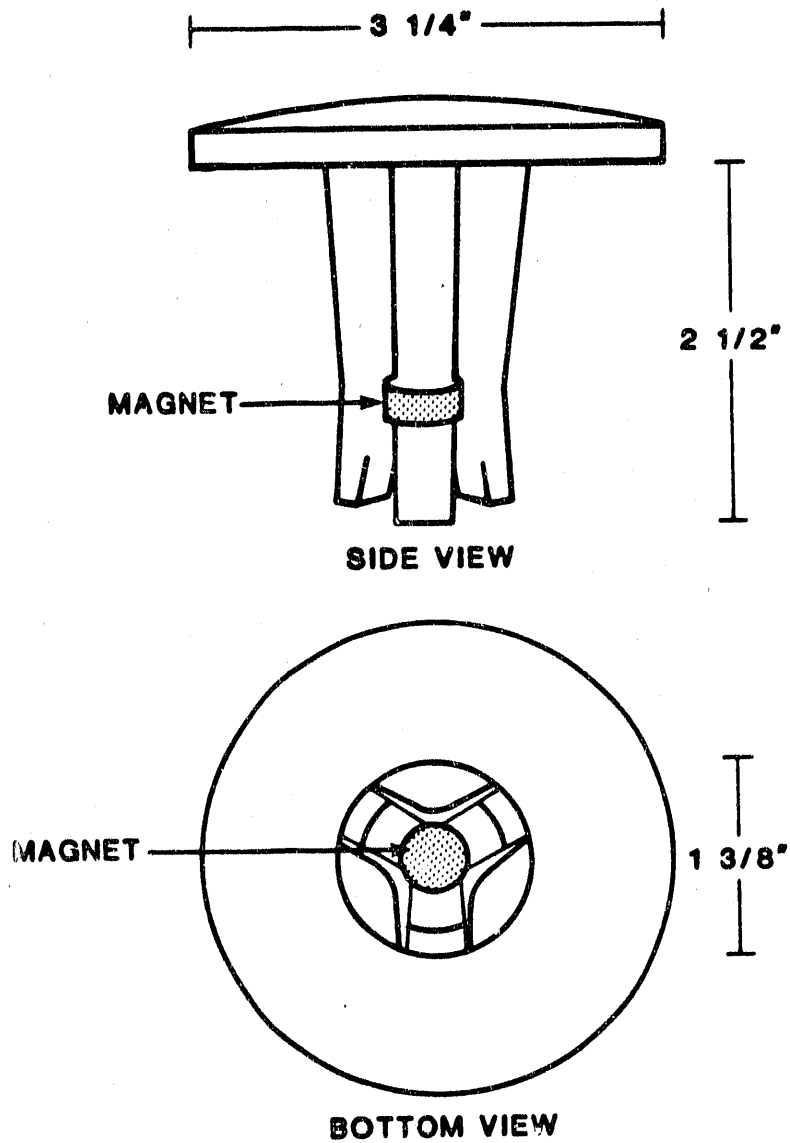

FIGURE 2.1 BERNTSEN RT-1 MARKER

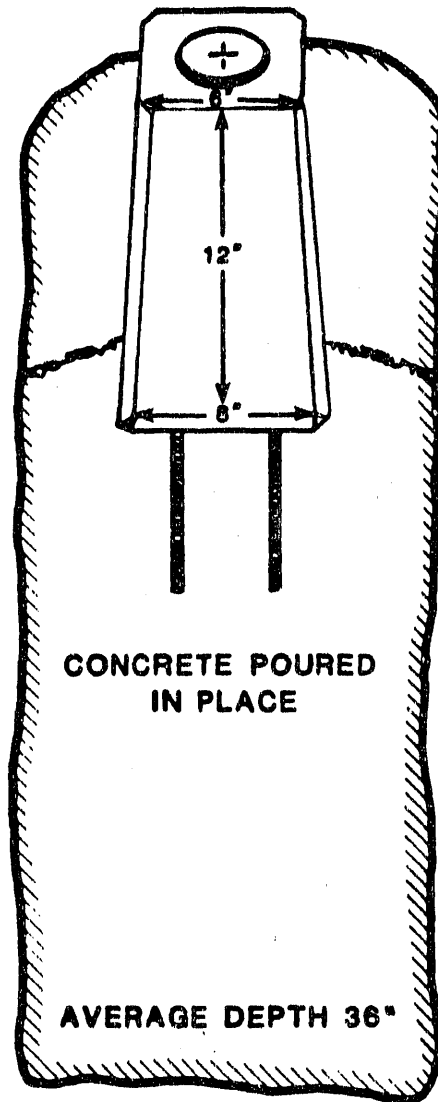
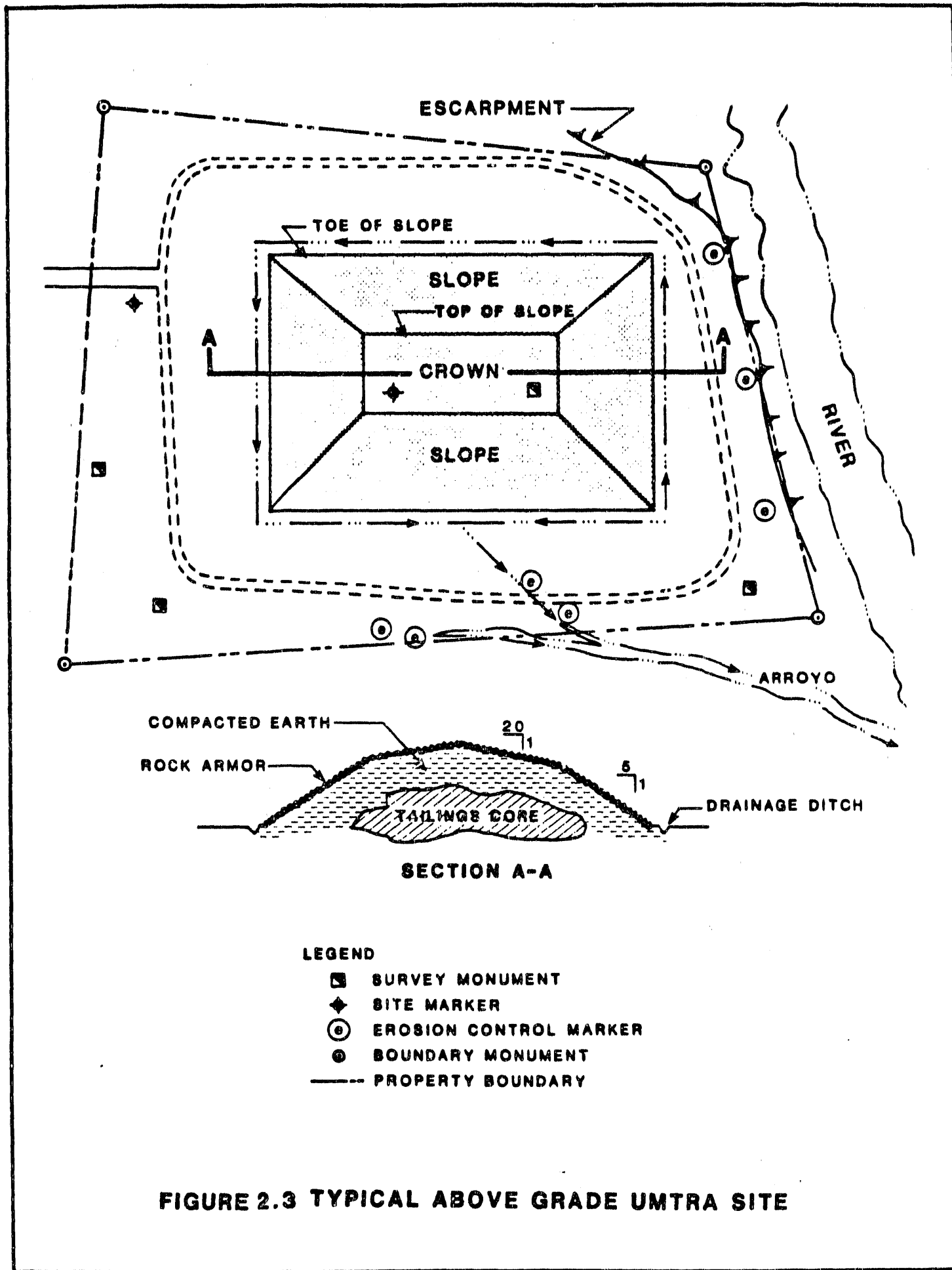

FIGURE 2.2 PRECAST STATION MONUMENT SET IN SOIL



required to permit recognition of the site's boundaries. The position of the boundary monuments will be determined by a survey of the same precision as used in establishing the site survey monuments (see Section 2.6.1).

These monuments will be selected for long life and for recoverability in the event of wind or water sedimentation. The Berntsen Federal aluminum survey monument (Model A-1), or equivalent, will be used (Figure 2.4). This monument is designed to eliminate metal corrosion, is light-weight, and has permanent ceramic magnets epoxied in the cap and base, vertically oriented for maximum detection if covered. The standard monument length is 30 inches, but is available in lengths up to 10 feet. Monuments in excess of the standard 30-inch length may be required in areas of possible erosion, flooding, or in soft soil conditions.

2.6.3 Site markers

Each site will have two granite (or equivalent) site markers which will identify the site and the general location of the tailings on the site, and show the date of closure, the tonnage of tailings, and the curies of radioactivity. One site marker will be placed at the entrance to the site, or, if there is no defined entrance, on the boundary of the site closest to the nearest public highway (Figure 2.3). The second site marker will be placed near the center of the crest of the embankment, or if the tailings are below grade, at the center of the site.

The site markers will be unpolished granite with minimum dimensions of 36 inches in length, 24 inches in width, and 18 to 24 inches in depth. Lettering and other marking will be incised 0.25 to 0.50 inch.

The site markers will be set in a bed of reinforced concrete which extends below frost line. The incised face will be approximately horizontal, but with sufficient slope to prevent the accumulation of water, ice, or soil. The site markers should be slightly above ground (18 to 24 inches).

The elevation and position of the site markers will be determined by a survey of the same precision as used in establishing the site survey monuments (see Section 2.6.1).

2.6.4 Signs

Signs will be placed at intervals around the perimeter of the site to indicate that it is government property, that it contains uranium mill tailings, and that trespassing is forbidden. The perimeter sign at the entrance to the site, or in the absence of a defined entrance the perimeter sign closest to the nearest public highway, will display the name of the site, the name and telephone number of the responsible agency, [the international symbol that indicates the presence of radioactive materials,] and the following:

OPTIONAL LOGO CAP

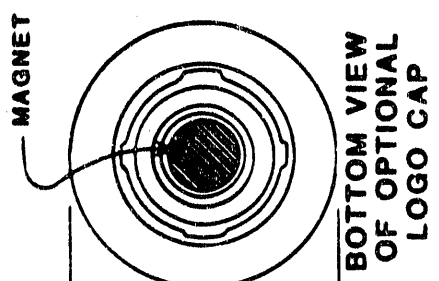
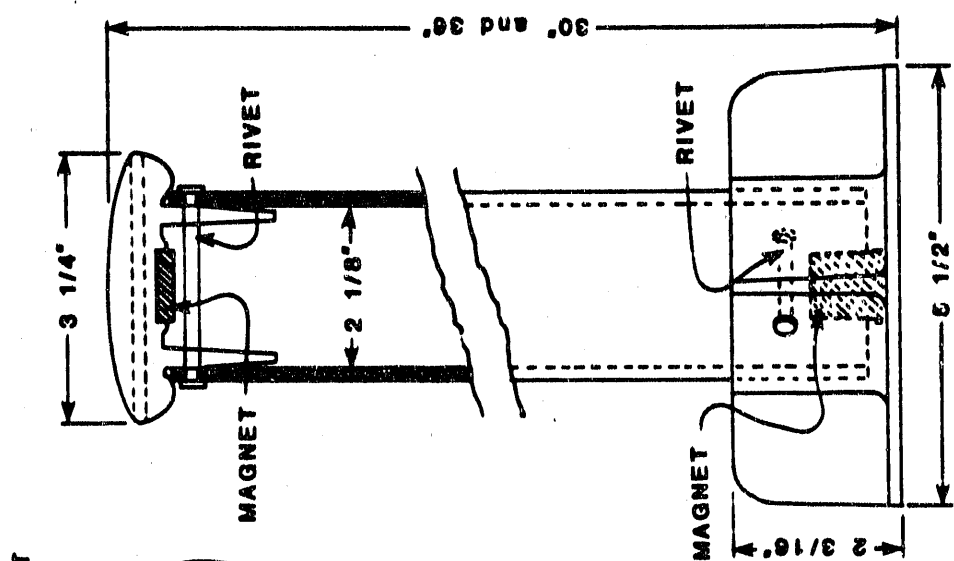

BOTTOM VIEW OF OPTIONAL LOGO CAP

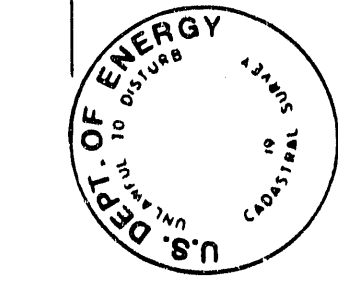

BOTTOM VIEW OF STANDARD LOGO CAP

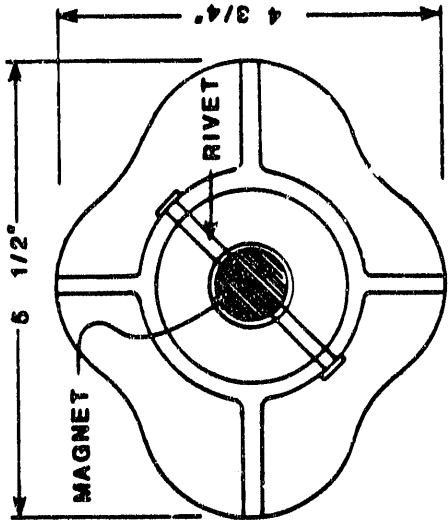
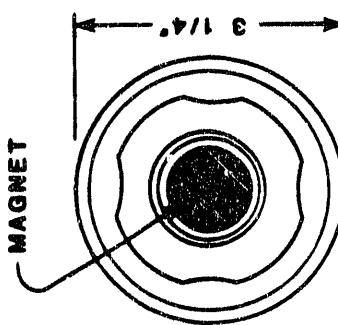

TOP VIEW OF BASE

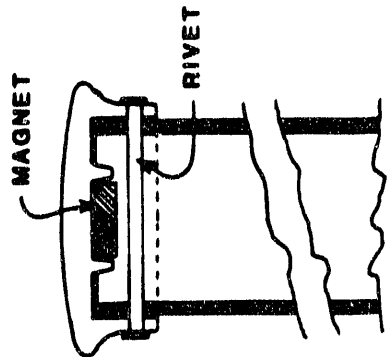

STANDARD LOGO CAP

FIGURE 2.4
BERNTSEN A-1 MONUMENT

No Trespassing
Uranium Mill Tailings
U.S. Government Property

in English and Spanish (where appropriate).

Perimeter signs will be located so that one or more signs will be visible in daylight to a person approaching from any direction. In no instance will they be more than 500 feet apart, but where topography or vegetation may obscure them, will be appropriately closer.

The signs will be 18 inches by 24 inches, and at those sites which have a perimeter fence, the signs will be mounted on the fence about six feet above ground level. If no fence is present, the signs will be mounted on a dual steel standard of the type used by highway departments for highway signs.

No material is specified for these signs, but consideration [will] be given to plastic signs which are light-weight and can be readily replaced as necessary during inspections.

2.6.5 Survey standards

All follow-on surveys conducted during Phase II inspections will be made to second order standards.

2.6.6 Aerial photography

Aerial photo targets will be established prior to the first flight immediately after completion of the remedial action. Second order Class I horizontal control stations and third order vertical control stations will be established as described in the Manual of Photogrammetry (4th Edition) (ASP, 1980). The location of section corners and quarter corners within 200 feet of each site will be targeted. Three additional targets will be established on or around each site. Targets will be aluminum panels painted flat white and secured with ground anchors. Alternately, markers fabricated from other durable materials will be acceptable. Markers will be repainted or replaced as required.

2.7 MONITOR WELLS

[The primary well network used to monitor post-closure conditions will be the wells installed prior to or during remedial action provided that they were not damaged during remedial action and have appropriate locations and depths. Continued monitoring of these wells is important because they will provide an objective estimate of the effectiveness of the remedial action. Additional wells may be installed following remedial action (Section 4.1). The primary network will ensure:

- o Representation of post-closure conditions of the soil, rock, and water.

- [o Proper and complete coring and archiving.
- o Proper and uniform well completion and development.
- o Consistent and complete documentation of all field procedures.]

Wells drilled before remedial action that are only slightly damaged during construction will be a secondary monitoring network. The secondary network will be used to support water-level data collected at the primary wells.

Because wireline logs are useful analytic tools in determining site geology and borehole conditions, temperature, caliper, electric, and gamma logs will be run on each open borehole prior to well installation. [This information will be available for comparison to previously collected data and hydrogeologic interpretations.] See Section 4.1 for a more detailed discussion on the collection of ground-water background data.

2.7.1 Well drilling and coring procedures

For each monitor well, the entire bored interval will be sampled. Shelby tubes or split spoon samples will be taken through unconsolidated material (soil) and NX- or NQ-wireline sized core will be taken through consolidated material (rock). For rock coring, a face discharge bit, side discharge bit, and impregnated bit will be utilized. A split inner-barrel will be used to receive the core.

[When appropriate,] six-inch hollow stem augers will be used for borings through unconsolidated material. Gear bit-rotary wash drilling will be used for drilling through rock following coring. [Should conditions dictate, other drilling methods will be employed.] The reamed out hole will be [eight] inches in diameter.

The drilling rig and all bits, tools, casing, and equipment used to drill or bore each hole and complete each well will be washed with water before beginning each hole.

Air is the preferred media to cool the bit; potable water is acceptable only after air is used unsuccessfully. An organic polymer will be used only if water is found to be unsatisfactory.

Core recovery will be [maximized]. The core runs will be a minimum of 10 feet in length. [In addition, color photographs of core and split-open soil samples with appropriate scale information will be produced and archived.] The cores and soil samples can be used, in part, to determine the depth and the length of the screened intervals (see Section 2.7.2). Also, the samples and cores will be tested for residual contamination which will partially determine background and baseline conditions (see Section 4.2). [Lithologic logs will be maintained.] [All samples will be archived by the responsible agency.]

The driller will keep a bound daily log of all activities and accomplishments at the site as well as any changes encountered in the field. At a minimum, the following items will be recorded in a daily log during drilling:

- o Rate of drilling.
- o Percent drilling fluid recovered.
- o Changes in drilling fluid, water color.

The log will become part of the site file.

2.7.2 Monitor well installation and development

For any network of monitor wells, the screened interval of each well will be of prime importance. The appropriate depth and length of the screened [and packed] interval will be determined by:

- o The static water level in water-table (unconfined) systems or the depth [to the top of the] confined systems.
- o Careful analysis of cores to determine the more permeable, saturated zones.
- o Consideration of uniformity between comparable wells.

[o Ground-water flow gradients.]

The screened interval and/or gravel pack will extend from the measured water level [in an unconfined aquifer and from the top of a confined aquifer] downward. Because the more permeable zones could represent preferential pathways for ground-water flow, these zones will be included within the screened interval. If possible, comparable wells (upgradient and downgradient wells with identical or similar baseline water-quality conditions) will be screened through the same strata and completed and developed identically. This will ensure that differences in measured water levels represent the lateral hydraulic gradient rather than a composite of the vertical and lateral hydraulic gradients, and that samples for analysis are collected from the same intervals of the same producing zone.

[Details of monitoring well installation and development will be specified in the site surveillance and maintenance plan. The installation and development techniques will ensure that the appropriate data can be collected from each well with adequate quality assurance.] A typical monitor well installation is shown on Figure 2.5.

[Three or four] forms will be completed during drilling:

- o Borehole/well construction log - (Figure 2.6).
- o Well completion record - (Figure 2.7).
- o Borehole logs - (Figure[s] 2.8 [and 2.9]).

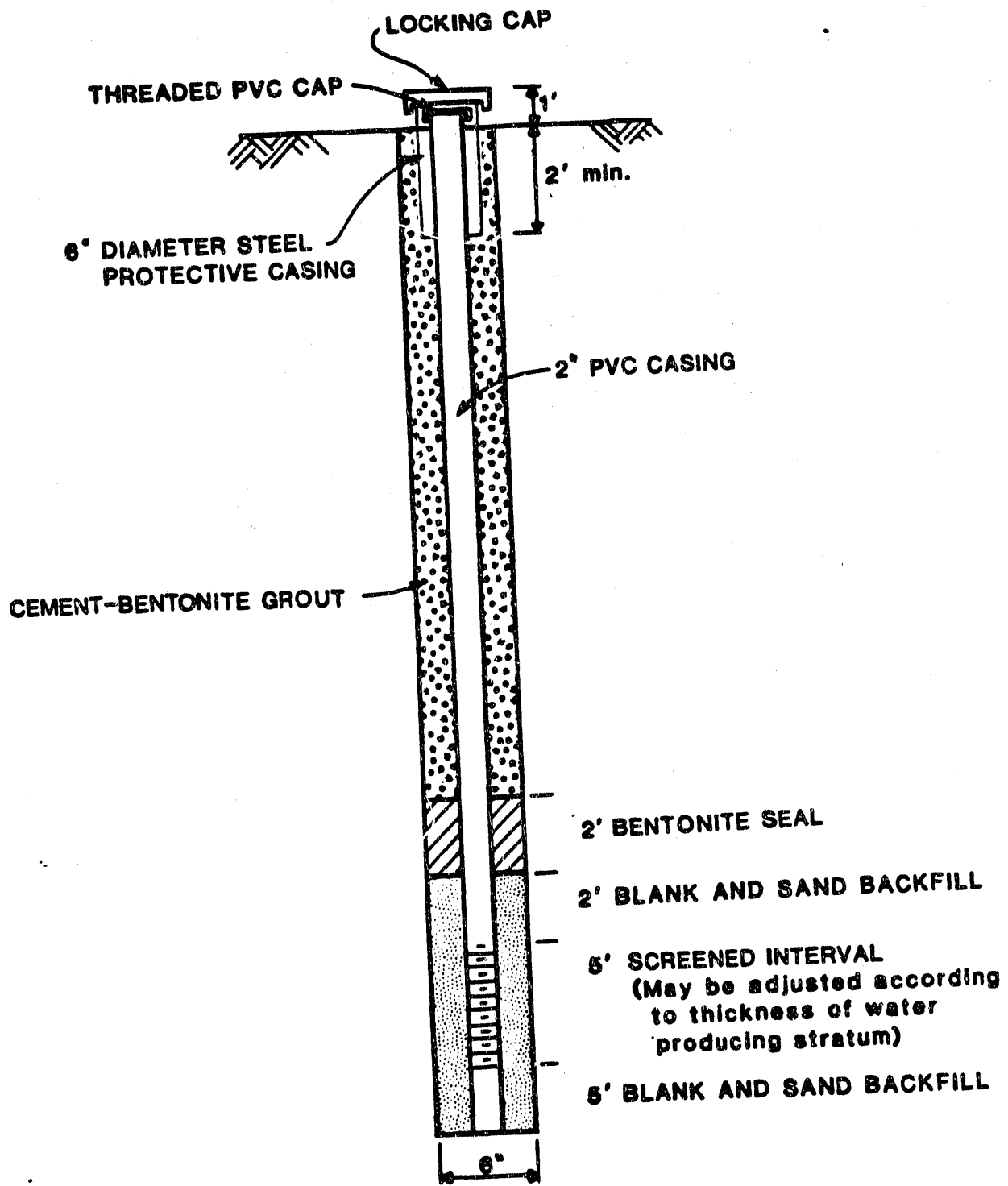

FIGURE 2.5
TYPICAL OBSERVATION WELL

FIGURE 2.6
BOREHOLE/WELL CONSTRUCTION LOG

SITE ID: _____ LOCATION ID: _____ FIELD REP: _____
 APPROX. SITE COORDINATES (FT.): N _____ E _____
 GROUND ELEVATION (FT. MSL): _____ COMPLETION DATE: _____

BOREHOLE SUMMARY				CONSTRUCTION TIME LOG							
DRILLER: _____				ACTIVITY	START		END TIME				
RIG TYPE: _____					DATE	TIME					
BIT TYPE	HOLE DIA. (in.)	END DEPTH (ft.)	FLUID TYPE	DRILLING							
CASING SUMMARY				CASING							
CASING TYPE*	DESCRIPTION	DIA. (in.)	END DEPTH (ft.)					FILTER PACK			
				SEAL							
				BACKFILL							
				DEVELOPMENT							
				OTHER							
* P-Protective S-Screen B-Blank O-Open N-None											
‡ Depth from Top of Casing											
WELL CONSTRUCTION				WELL DEVELOPMENT							
TYPE CODE*	DESCRIPTION	END DEPTH (ft.)									
				COMMENTS: _____							
* B - Backfill S - Seal F - Filter Pack											
‡ Depth from Ground Surface											

FIGURE 2.7
WELL COMPLETION RECORD

SITE ID: _____ LOCATION ID: _____ DATE INSTALLED: _____
 APPROX. SITE COORDINATES: (FT.) N _____ E _____
 OPEN AREA PER LINEAL FT. (IN²/FT.) _____
 FORMATION OF COMPLETION: _____
 FIELD REP.: _____ DRILLER: _____

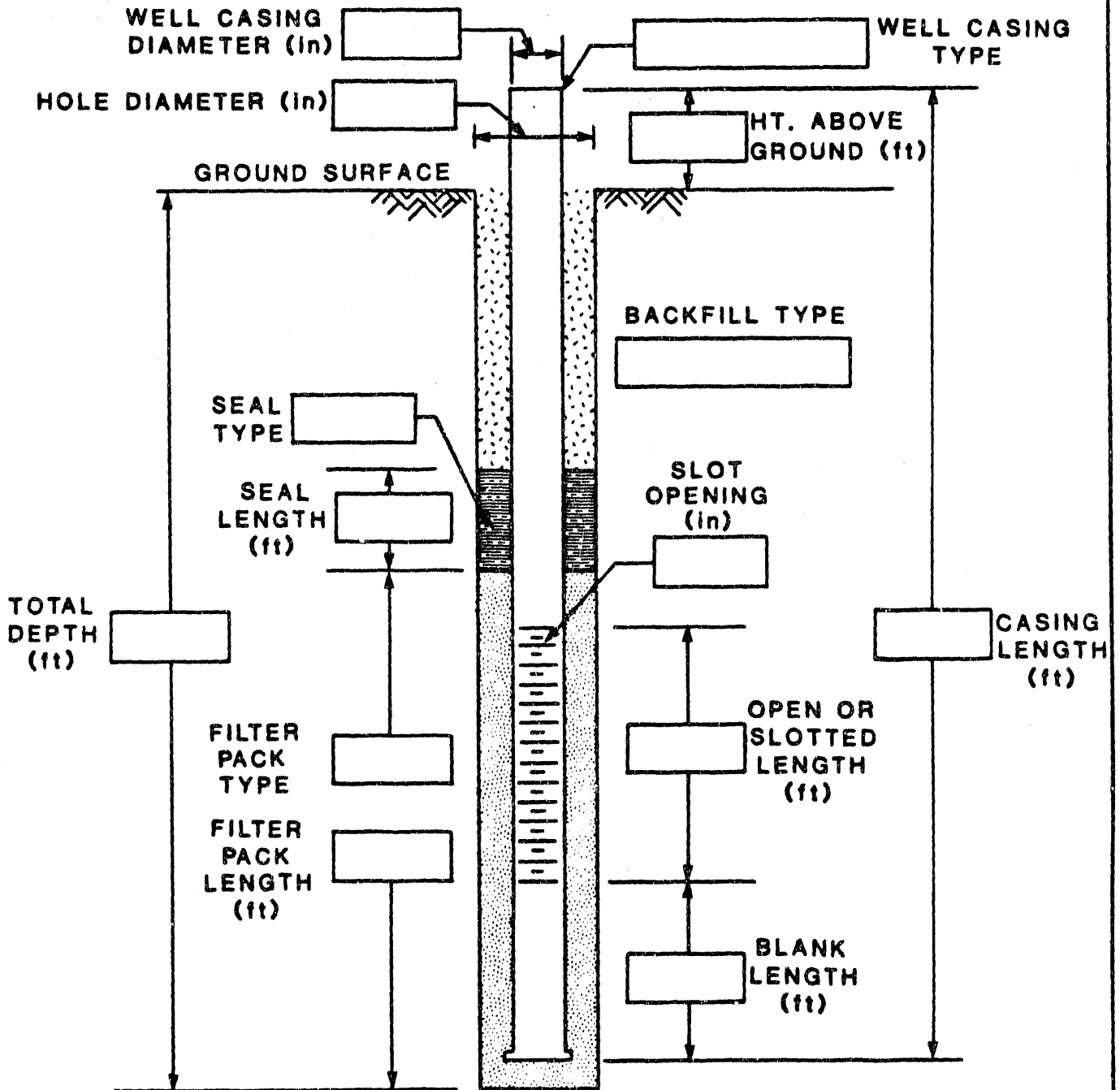

COMMENTS: _____

The site coordinates and ground elevation at each well will be surveyed to [second order standards.] This information will be added to the forms [(Figures 2.6 through 2.9)] following the survey and will become part of the site file.

If new wells need to be installed due to damage or deterioration of existing wells or investigations following the detection of an excursion (i.e., compliance monitoring), these new wells will be bored, drilled, and installed according to the procedures of Section 2.7.

[2.8 SETTLEMENT PLATES

Settlement plates may be required at disposal sites. The need for, and location and spacing of, plates will be determined by consideration of the following factors:

- o Pile configuration - steeper slopes may require monitoring.
- o Distribution of materials through the embankment.
 - Extensive slimes zones will require a denser spacing of plates.
 - Piles with in-situ tailings will require a denser spacing of plates than completely recompacted piles.
 - Concentrated zones of deleterious material such as organics or rubble may require a denser spacing.
- o Nearness of natural slopes to a pile may dictate placement of plates.

Should plates be determined to be necessary, the following program, at a minimum, will be required.

- o Three plates equally spaced on a line perpendicular to the topography of the steepest slope.
- o On top of the pile, one marker will be placed adjacent to each sideslope.

Figure 2.10 shows the detail of a typical settlement marker.]

2.[9] ADDITIONAL REQUIREMENTS

Depending upon site-specific problems anticipated, additional instrumentation may be required as part of the final site conditions. For example, where bank undercutting or channel migration can conceivably impinge upon a site, [erosion control] markers (e.g., driven, capped rebar rods) will be installed prior to the first Phase I inspection at critical locations along the stream path or bank. These rods will be surveyed into the permanent site control monuments. Regular measurements will be made with the objective of determining rate and extent of change.

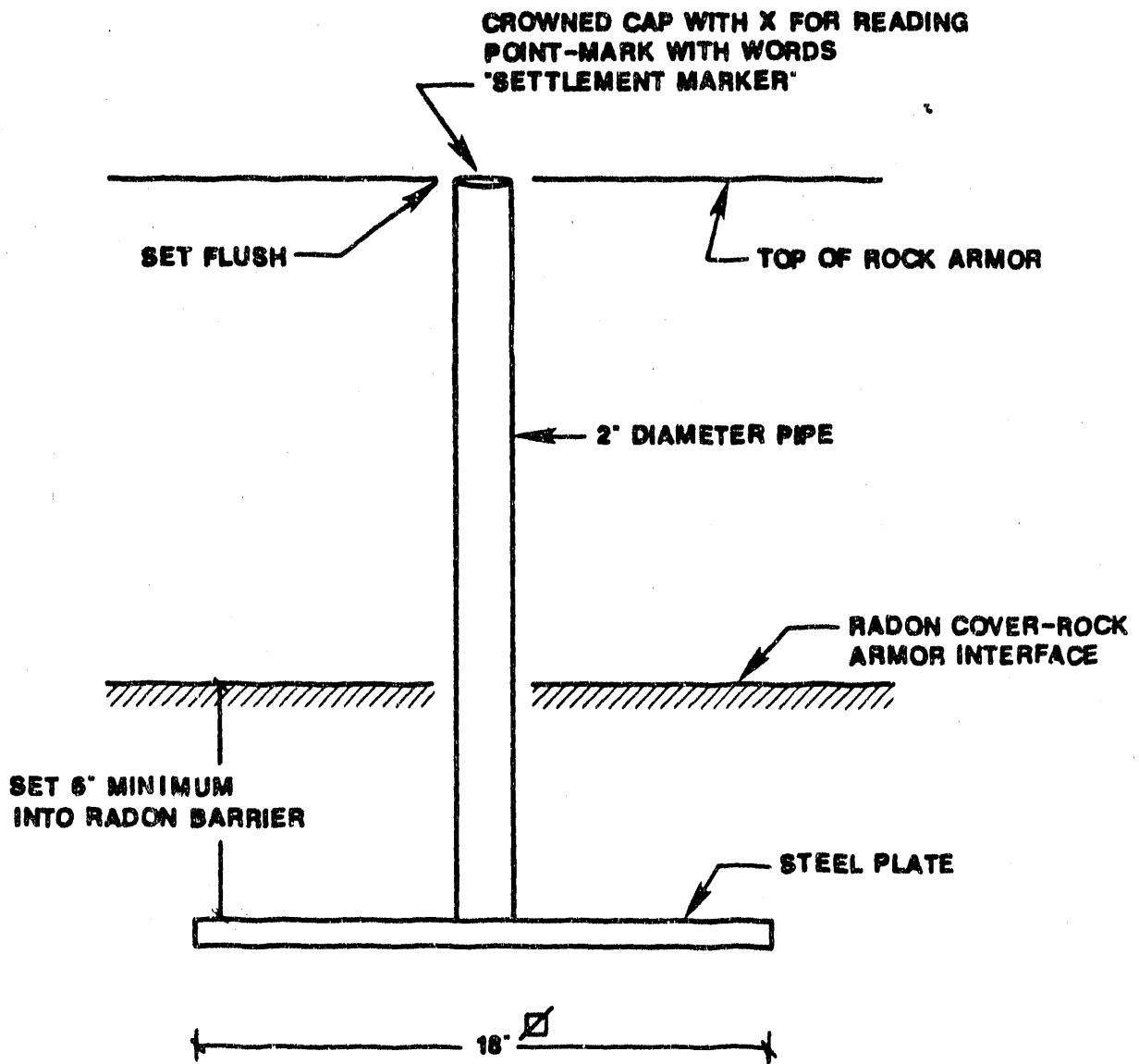

FIGURE 2.10
TYPICAL SETTLEMENT PLATE

3.0 SITE INSPECTION

3.1 INTRODUCTION

The on-site inspection is the best means to ensure that the disposal site continues to function as designed. Three types of site surveillance[s] are discussed in Section 3.2:

1. Phase I inspections.
2. Phase II inspections.
3. Contingency inspections.

The procedures to conduct Phase I and Phase II inspections are discussed in Sections 3.3 and 3.4, respectively.

3.2 TYPES OF INSPECTIONS

3.2.1 Phase I and Phase II inspections

Phase I inspections will be conducted on a regular basis for several years to develop a record of changes in the site. Initially (10 years), the Phase I inspections will be conducted during years 1, 2, 3, 5, 7, and 9; the responsible agency may alter the frequency of inspections thereafter [with NRC approval]. Phase I inspections will be undertaken by a small number of trained personnel using common and simple instruments. The procedures in Section 3.3 have been provided to guide the inspectors and to establish standard procedures for Phase I inspections.

Phase II inspections are a second level of follow-up inspections to further investigate and quantify specific site problems when detected by a Phase I inspection (Figure 3.1). A Phase II inspection will be ordered by the responsible agency and will be conducted by technical specialist[s] experienced in investigating the type of problem encountered at the site.

In this plan, procedures for a Phase II inspection are not specified but will be specified by the responsible agency at the time at which this inspection becomes necessary. It is conceivable that a Phase II inspection could be carried out in two or more steps. The first step would be an on-site visit to gather first-hand knowledge for the development of a plan-of-action to conduct the tests necessary to understand the phenomenon in progress. Follow-on visits would then be undertaken to gather the data needed to draw conclusions and recommend mitigative or remedial actions.

3.2.2 Contingency inspections

Contingency inspections are unscheduled, situation-unique inspections ordered by the responsible agency when it receives outside information that indicates that site integrity has been or may be threatened. The trigger event for a contingency inspection

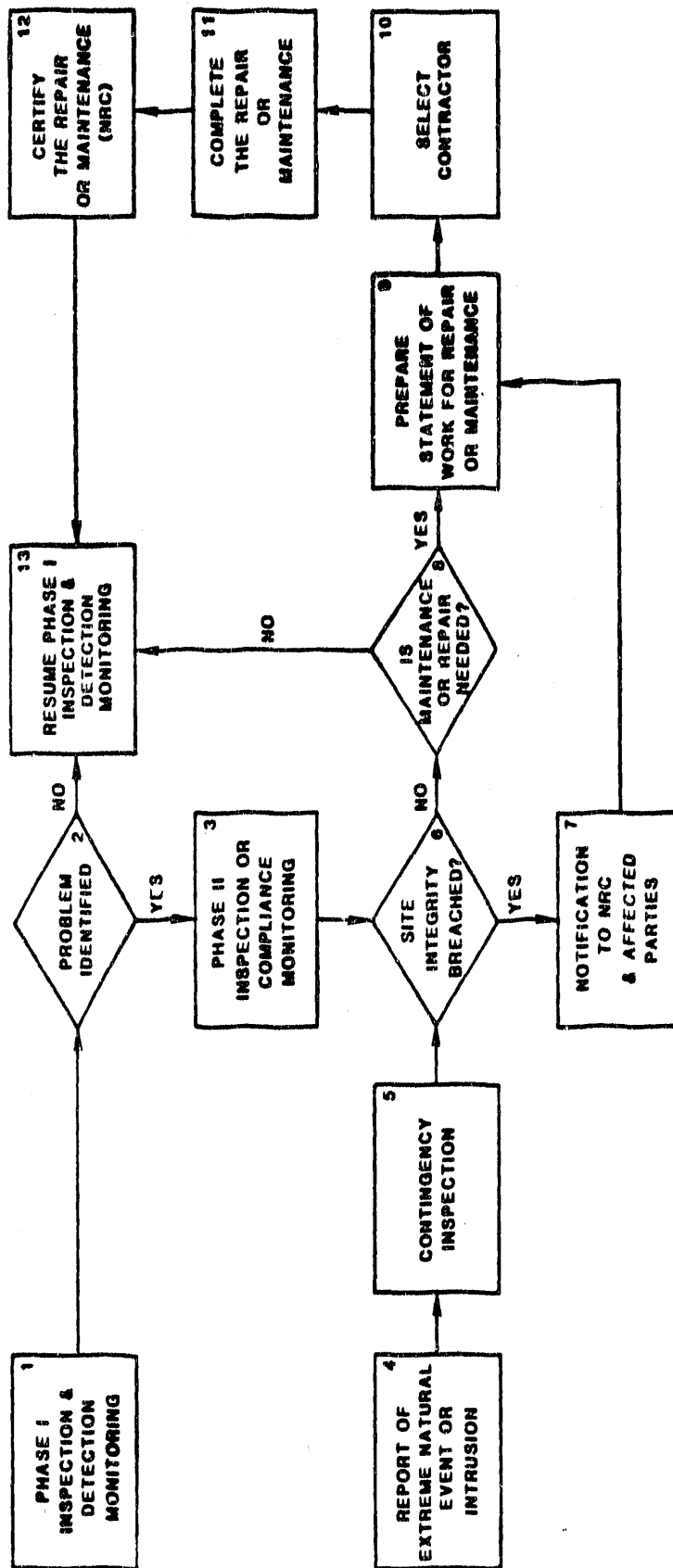

FIGURE 3.1
SURVEILLANCE AND MAINTENANCE PROCESS

may be a report of continuing intrusion by livestock herds, or a report of a natural event such as an earthquake, or a large rain-storm on the watershed. The type of contingency inspections to be conducted will be specified by the responsible agency.

As part of a site contingency plan, procedures will be established by the responsible agency to ensure that the agency is notified of extreme seismic or meteorological events. The contingency plan will also identify names, addresses, and phone numbers of local or state officials or agencies to be notified.

The determination of an extreme seismic event will be dependent on the particular site design and construction. Knowledge of seismic event occurrence will be obtained by responsible agency subscription to the U.S. Geological Survey's Earthquake Early Warning Service. This service provides data on the magnitude of the event and the location of the epicenter. Application to subscribe to the Earthquake Early Warning Service will be made to:

U.S. Geological Survey
National Earthquake Information Service
Box 25046
Mail Stop 967
Denver Federal Center
Denver, Colorado 80225[.]

To obtain notification of extreme meteorologic events, the responsible agency will establish a dialogue with the National Weather Service, National Oceanic and Atmospheric Administration, or other agency to investigate data gathering and reporting systems that would best serve to alert the responsible agency. The responsible agency will complete an interagency agreement for a continuing reporting service.

3.3 INSPECTION PROCEDURES (PHASE I)

Discussed in this section are those background details and preliminary considerations necessary to conduct site inspections including the inspection team, frequency and timing of inspections, and inspection aids. Also discussed are the procedures necessary to recognize various site modifying processes during site inspections.

3.3.1 Preliminary considerations

a. Frequency and timing of inspections

Phase I inspections will be conducted at each site during years 1, 2, 3, 5, 7, and 9 following completion of remedial action. These inspections are necessary to establish and record physical modifications to the site through many seasonal cycles and to provide a basis for decisions regarding future inspections. At the 10-year point, the responsible agency will evaluate all inspection and maintenance reports

and records and will specify a new Phase I inspection frequency [to be concurred in by the NRC.]

Timing of Phase I inspections, as determined by the responsible agency, will take into consideration such factors as:

- o Inability to reach the site due to snow cover, runoff, or impassable roads.
- o Inability to inspect due to snow cover.
- o Climatic cycles most likely to adversely impact the site such as periods of heavy precipitation, runoff, or wind.
- o Need to acquire data to confirm aerial photography data or reports from concerned citizens.

Should the inspectors find weather conditions at the site not conducive to making a complete and thorough inspection, they will use the opportunity to observe and record modifications to the cover, diversion ditches, and other site features. The remainder of the inspection will then be rescheduled for a more favorable day.

b. The inspection team

The Phase I inspection team will consist of a chief inspector and one or more assistants. The minimum number on a team is two; more can be assigned depending on the conditions expected at the site and the size of the site. For example, a surface-water hydrologist may be necessary at sites that reside near a river or stream [or a sampling specialist will be needed to retrieve ground-water samples]. [If only two inspectors are assigned, one will be a geotechnical engineer/geologist and one will be a civil engineer. When ground-water samples must be collected, two specialists versed in sampling/preservation techniques will comprise the field team and will be independent of the site inspection team.] Inspection team size will be specified by the responsible agency prior to each inspection.

The chief inspector will have a degree in civil engineering or soil mechanics and at least five years' experience (or an equivalent amount of experience/education) in projects involving the planning and implementation of earthen structure designs. When possible, the chief inspector will have made at least one site inspection as an assistant inspector. Assistants will have degrees and experience complementing the chief inspector's as appropriate for the nature of the site and the expected site conditions. Assistants will have a minimum of three years' experience in their field.

The chief inspector and assistants will be designated by the responsible agency prior to each inspection.

c. Familiarization with site characteristics

The site inspection team will become familiar with a site by reviewing [the site file (also see Section 7.2). Key elements of the site file include:]

- o The license (includes surveillance and maintenance requirements).
- o The site as-built drawings and drawings modified to reflect changes made as a result of post-remedial action custodial maintenance or contingency repair actions.
- o Reports from ground-water monitoring.
- o Previous Phase I and II inspection reports.
- o Custodial maintenance reports.
- o Contingency repair reports.
- o Aerial photos and interpretive reports.
- o Final certification report.
- [o Final processing site characterization report or disposal site characterization report (specifically surface and near-surface geologic/geomorphic features).]

[o Site atlas.]

d. Preparations for conducting inspections

After site familiarization, preparations must be made to conduct field inspections. This requires the inspection team to:

- o Obtain approval to enter adjacent property (if required).
- o Assemble the equipment needed to conduct the inspection. Equipment will include such items as camera[s] and film, binoculars, tape measure, optical ranging devices, Brunton compass, photo scale stick, erasable board, additional signs, [hand lens, and others.] Each site-specific checklist will contain a list of the field equipment needed for the inspection.

3.3.2 Site inspection

a. Introduction

The primary objective of the site inspection is to identify potential problems at an early stage prior to the need for

significant maintenance or repairs. The inspection team will be guided by a knowledge and understanding of the processes which could adversely modify the site. A fundamental part of the inspection will be the detection of change, and particularly the progressive change, over a number of years due to slow action processes. These processes and signatures of their activity are discussed in Appendix B, Modifying Processes.

To assist the inspection team, the checklist shown in Appendix C will be used. Detailed field notes will be appended to the checklist. The overlays to the base map (site atlas - Section 2.5) will also be used to record observations. Photographs will be taken (see Section 3.3.3).

b. Field procedures

Adjacent off-site features

A reconnaissance of the adjacent area within 0.25 mile of a site boundary will usually be the first stage of a site inspection. Any evidence of a change in land use will be described. The development of inadequately engineered roads and trails may, because they concentrate runoff, lead to initiation of gully erosion; increased use in any form is likely to bring about a reduction of vegetation cover and, therefore, an acceleration of erosion. In general, any increase of human activity in the vicinity increases the probability of either inadvertent or purposeful human intrusion into the site.

If a site is near a stream, and particularly if it is on the floodplain or a terrace of a stream, evaluation will be made as to whether the stream poses any threat to the site. An "overview" observation from a prominent topographic feature will be made first. Such observation can be expected to indicate high water levels, areas of active erosion and sedimentation, and potential changes in channel position.

The adjacent stream reaches will then be walked for several thousand feet and notes made of unusual or changed sediment deposits, large debris accumulations, made-made or natural constrictions, and recent or potential channel changes. Any such features will be liberally documented with photographs which will include recognizable landmarks and known objects for scale.

Similarly, any gullies or locations which appear to be favorable to the development of gullies will be examined. The position of the head of the gully will be the most important observation, but the shape of the cross-section will give an indication of the degree of activity, and any interruption in the longitudinal profile may suggest rejuvenation or the presence of a local base level.

Access roads, fences, gates, and signs

Sites will be accessible by automobile and will have a perimeter road. The condition of these roads will be described and if maintenance is indicated, the location and type of work will be recommended. Roads and associated grading are frequently points of gully initiation, and near the site particular care will be taken in looking for evidence of recent erosion associated with the roads.

A walking traverse of the fence will be made (Figure 3.2) and any breaks in the perimeter fence or conditions which might lead to a break will be described. If human intrusion is indicated, an effort will be made to determine whether it was inadvertent or purposeful, and if the latter, whether it poses any threat to the site. Of special concern would be evidence of removal of material from the site.

Missing, badly damaged, or defaced signs will be replaced.

Monuments [and wells]

Each survey monument, boundary marker, site marker, [and above ground well casing,] will be examined for evidence of disturbance. If any have been disturbed, a recommendation for their re-establishment and possible protective action will be made.

Crest

The crest of an above-grade site is an obvious vantage point from which to examine the site and the surrounding area. Observations, with the aid of binoculars, will be made in all directions of any features which are anomalous or unexpected, and which may require a closer inspection. These features will be recorded on the checklist and overlay. Examples of such features that might be observed include changes in soil color, unusual vegetation patterns, trails, and patterns of erosion.

A walk around the edge and along diagonal transects of the crest will be made (Figure 3.2). Additional transects, at approximate 50-yard intervals, will be walked along the sideslopes. A search will be made for evidence of differential settling, subsidence, and cracks, if any. The patterns of cracks and evidence of subsidence will be described on an overlay and photographed. The depth and width of the cracks will be measured; notes will be made of any points at which the cracks may extend below the outer erosion barrier.

Erosion of the crest is not expected to be a problem because of the low slopes and the fact that the crest, in most cases, will be covered with a rock erosion barrier designed to protect against rills, rivulets, and gully erosion. However,

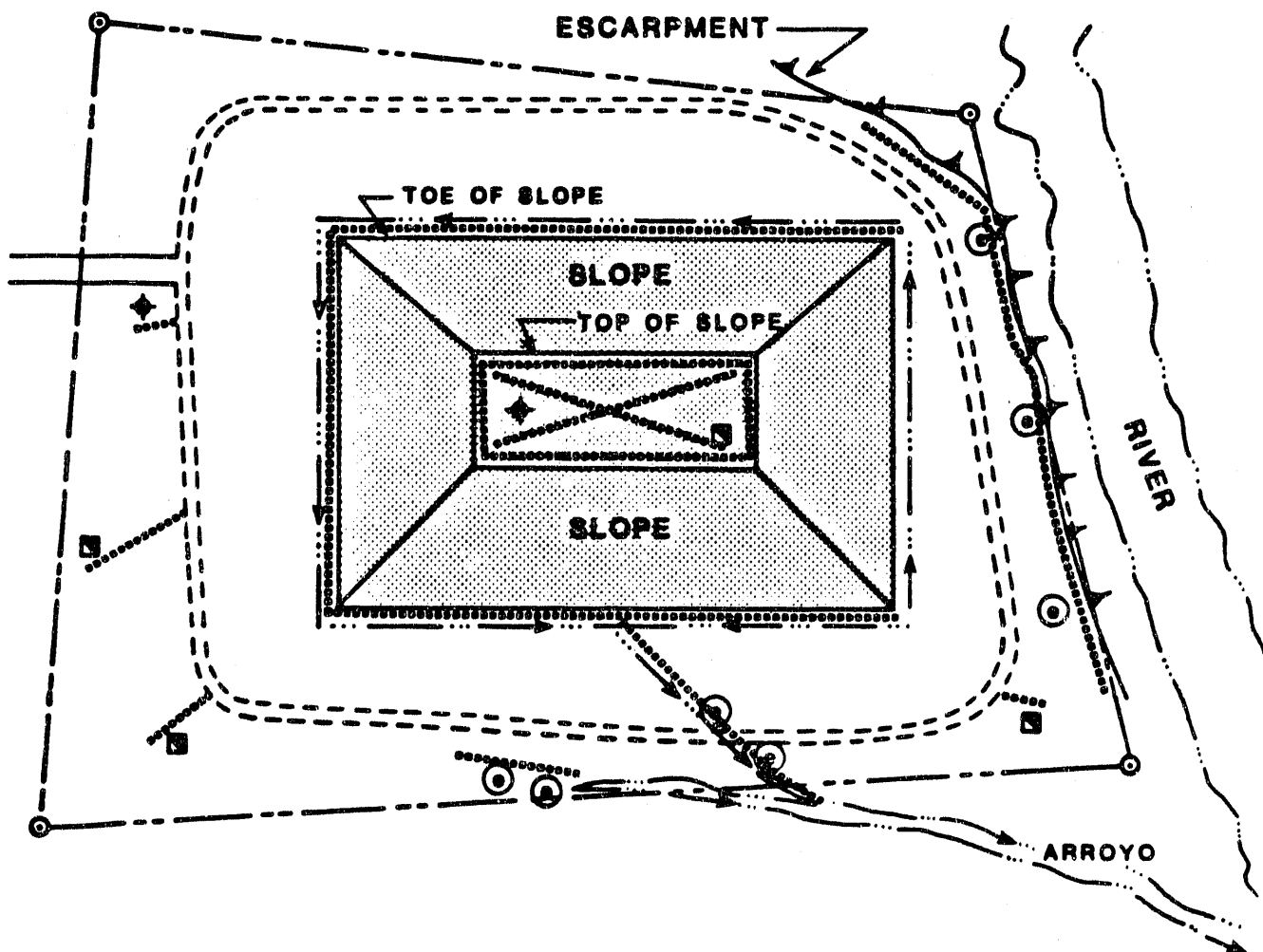

LEGEND

- SURVEY MONUMENT
- ◆ SITE MARKER
- ⊙ EROSION CONTROL MARKER
- BOUNDARY MONUMENT
- PROPERTY BOUNDARY
- ⋯ ROUTE FOR WALKING INSPECTION
- - - ACCESS ROAD
- DIRECTION OF FLOW

**FIGURE 3.2
TYPICAL ROUTE FOR SITE INSPECTION**

differential settling or sliding along the slopes may cause flow concentrations which may disturb that protection and thus, irregularities will be examined for early evidence of erosion.

[The rock cover will be examined for evidence of rapid deterioration. Individual rocks will be examined with a hand lens for excessive fracturing, oxidation, or other signs of deterioration.]

At sites where there is no rock protection, evidence of wind erosion including the presence of ripple marks, partially exhumed vegetation, the presence of pedestal rocks, or obvious lag gravels will be noted.

On those sites at which revegetation has been part of the design, careful examination will be made to determine irregularities in species composition and density of vegetation.

Slopes

Modifications to the disposal site are most likely to occur on the lower portion of the slopes. Therefore, a careful examination at the toe of the slope will be a key part of the inspection (Figure 3.2). For embankments less than 20 feet high (slope length less than 100 feet), a single traverse at the toe or slope will ordinarily be adequate. For higher embankments, one or more additional traverses on the upper slopes will be made.

Settlement or sliding, although highly unlikely, will be apparent by the presence of bulges and depressions, cracks, and scarps. If any such features are observed, an effort will be made to determine the extent of the area affected, whether the area is stable or likely to continue moving, and the nature of the movement that is occurring (settlement, planar, or rotational sliding). Evidence of related erosion will be noted. Photographs showing both detail and area perspective will be taken.

Creep is more subtle and, if occurring, is unlikely to be observed for many years after construction. Typical evidence includes the presence of plants with their root systems upslope from their stems, small terrace-like features ("sheep tracks"), and a gradual change in size distribution of gravel with the coarse material downslope.

Any localized change in color (e.g., "stained" vegetation) or concentration of vegetation will be described and examined for evidence of seepage.

During the inspections, the slopes will be examined for evidence of animal intrusion, burrowing, changes in vegetation, and human activity.

Cattle or sheep may inadvertently wander onto a site but they are not likely to remain as long as the site is barren of vegetation. Eventually, however, vegetation will invade the site and may offer attractive forage. Regularly used trails can concentrate runoff and thus encourage erosion; these will be mapped and described.

Any signs of small animal trails or burrows will be noted and photographed, and the species tentatively identified. If animal burrows have been observed during previous inspection, the sites will be examined for indications of current activity.

If the site has been revegetated, the continuity and density of the vegetation cover will be noted, and areas where the cover has been destroyed will be mapped and described. Invader species, particularly large shrubs and trees, will be identified if present.

Erosion of revegetated slopes will be first apparent by the development of rills and rivulets which extend only part way up the slope. If they are present, their spacing, length, depth, and width will be measured. Particular attention will be placed on evidence of integration of the drainage and development of a master channel. Such a development can, in a short time, evolve into a gully.

At those sites on which the cover is rock, plant colonization will be slow to develop, but will gradually occur. The inspection procedure is expected to record this gradual colonization by noting the extent of vegetation, its location, species represented, and cover density.

When there is doubt as to the species present or when a Phase II inspection by a botanist is being considered, plant specimens will be collected.

Inadvertent or casual intrusion by humans is not of great concern, but evidence of removal of the cover, extensive vandalism to signs and monuments, or the presence of well-established trails will be described in detail.

Periphery

The area adjacent to the site will be examined during the traverse at the toe of the embankment. Features to be looked for and described, if present, include erosion channels, accumulations of sediment, evidence of seepage, and signs of animal or human intrusion.

Diversion channels

Each diversion channel will be walked for its entire length to determine whether the channels have been functioning, and can be expected to continue to function as designed.

The channels and sideslopes will be examined for evidence of erosion or sedimentation, slides or incipient erosion channels, debris, or growing vegetation. The sideslopes also will be examined for evidence of piping or burrowing by animals which could lead to sloughing of material into the channel.

If a portion of a channel has riprap or if there is a concrete spillway, the soil or rock material adjacent to the structure will be examined carefully for evidence of unstable conditions such as piping, or destructive currents. The riprap or concrete will be examined [with a hand lens] for [evidence of rapid] deterioration caused by weathering or erosion.

3.3.3 Ground photography

a. Equipment

The photographic equipment required for ground photography will consist of the following:

- o Two 35mm single lens reflex cameras with automatic exposure control, and interchangeable lenses.
- o Lenses with focal lengths of 45 to 55mm for all standard set photographs.
- o Lenses with focal lengths of 24 to 30mm and 105 to 180mm for use in photographing panoramic or unusual situations.
- o Two data backs for automatic film annotation of time and date.
- o Color slide film, ASA25 or equivalent.
- o Erasable board (about [one foot by two feet]) with black pens for captioning photographs.
- o Six-foot scaled board graduated in six-inch alternating black and white segments.

Miscellaneous equipment required includes extra batteries, camera cases, carrying straps, lens sun shades, filters, and lens cleaning supplies.

b. Standard photography sites

The photo overlay to the base map will specify the locations from which the standard set of photographs will be taken. The photo sites will usually be specified in relation to a survey monument, boundary monument, site marker, monitor well, or aerial photo control feature. While gate and fence locations may be used, these structures are not considered permanent enough for long-term historical use. Accompanying

the photo overlay will be a listing for each location that gives the desired azimuth and central feature for each photo.

The types of features included in the standard set of photographs will include:

- o Monuments, signs, and site markers.
- o Fences, gates, access roads, perimeter road, and paths.
- o Crest lines - both along the crest and at right angles to the crest.
- o Panoramic (360 degrees) from top (center) of the site.
- o Off-site features that may affect the site in the future.
- o Monitor wells.
- o Diversion ditches or other drainage features.
- o Others.

c. Special photographs

Documentary evidence of abnormal, anomalous, new, or unusual conditions or situations (e.g., downhill creep, terracing) will be obtained to provide a record of developing trends and to enable the responsible agency to make reasonable decisions concerning additional inspections, custodial maintenance, and contingency repair. Photographs provide such evidence and augment the checklist and annotated overlays.

Any site feature or condition which requires the inspector to make a written comment, explanation, or description (and can be photographed) will be photographed. The number of photographs, the view angles, and the lenses used will be up to the judgement of the inspector, keeping in mind site conditions, lighting conditions, and the goal of having sufficient photographs for agency review.

All special photographs will be logged on a Photo Log Form (see Appendix A, Inspection Photo Log).

d. Redundancy

To ensure that representative photographs are obtained, photographs will be taken with each camera and exposed film from one camera will be kept separate from film from the other camera. All film will be processed.

e. Records

A separate Photo Log Form will be filled out for every roll of film exposed. A Photo Log entry will be made for each photograph. Since a data back will be used, only the time for the first and last exposure on a roll must be logged. The completed log forms are to be attached to the inspection checklist and paginated accordingly.

3.4 PHASE II INSPECTIONS

3.4.1 Relation to Phase I

Phase II inspections will supplement Phase I inspections (Figure 3.1). These inspections will be conducted whenever the results of a Phase I investigation have indicated that in-depth studies are necessary to assess whether processes currently active on or near the site pose any future threat to the site if left unmodified.

Because of the EPA standards to which each site will be designed, it is considered extremely unlikely that problems will occur. However, some of the situations which may require Phase II inspections include:

- o Unforeseen subsidence of the embankment or its foundation.
- o Gullying which has cut through or is threatening to cut through the outer cover.
- o Slides on the slopes of the site.
- o Indicated rapid deterioration of the rock barrier.
- o A change in position of an adjacent stream channel.
- o Indications of rapid headward cutting of a nearby arroyo.
- o Cracks which extend deeply into the embankment (> six inches).
- o The presence of animal burrows on the site.
- o Invasion of shrubs or trees onto the site.
- o Removal of some of the site material.
- o Seepage.

Phase II inspections will be made by specialists in the discipline appropriate to the problem that has been recognized. That is, if erosion is the problem, the inspector(s) will be individuals knowledgeable in evaluating erosion, presumably a soils scientist or geomorphologist; if settlement or sliding is

the problem, a geotechnical engineer will be required; if changes in an adjacent stream, a hydrologist; if plant invasion, a botanist; and the like.

3.4.2 Phase II procedures and objectives

Phase II will include all additional studies and investigations necessary to evaluate the continuing effectiveness of the remedial action for protection and stabilization of the tailings. The procedures used will be those required in the judgement of the responsible agency and will depend upon the nature and severity of the problem. For the most part, when a Phase II inspection is ordered by the responsible agency, the site will be resurveyed to second order standards. Representative and appropriate responses for several possible problems are listed below:

- o Gullying on slopes - measurements or mapping not completed as part of Phase I will be done. The primary objective will be to determine the factors which led to the initiation of the gully. This may involve evaluation of the erosion barrier design parameters or site drainage, and the role of sheet erosion, rill formation, slides, or burrows. The product will be a recommendation for maintenance and preventive measures, if required.
- o Headward gully erosion - a Phase II investigation will establish procedures for determining the rate of headcutting. A line of reference stakes (capped rebar) upstream from the gully head is a simple and effective method of measuring change in the position of the gully. Comparison of periodic aerial photographs would be useful. An understanding of why dissection is occurring and any limiting conditions will be sought. Preventive measures may be planned.
- o Settlement - when settlement [appears to be] greater than had been foreseen, a Phase II [resurvey of settlement plates] will determine whether settlement is occurring [and to what extent.]
- o Creep - whether creep is occurring can be determined by setting rows of stakes parallel to contours on the side-slopes. These will gradually tilt downslope if creep is occurring. The rate of creep can best be determined by marking a number of rock fragments on the slopes and accurately determining their location in relation to existing or additionally emplaced survey monuments over a period of several years.
- o Landslides - when evidence of a slide or debris flow on a site has been found, an investigation will be made to determine the area and volume affected, the type of movement, the causal factors, and what remedial and preventive maintenance is required. Drilling, hand augering, or excavation may be necessary.

- o Vegetation - when large shrubs and trees have invaded the embankment, the species will be identified and their abundance determined. If deep-rooted species are present, analysis of plant material for radionuclides and heavy metals may be made. An eradication program may be ordered.

[3.4.3 Schedule and reporting

Once the Phase I inspection has identified a potential problem, the responsible agency will notify the NRC and begin a Phase II inspection by submitting a preliminary assessment of the potential problem and a Phase II inspection plan. Upon plan approval by the NRC, the plan will be implemented by the responsible agency. Once the Phase II inspection has been completed, the responsible agency will recommend maintenance or other actions to be performed, as needed.]

4.0 GROUND-WATER MONITORING

This section discusses the [guidelines] to [determine] the need for monitoring, background and baseline water quality, statistical procedures, detection monitoring, compliance monitoring, and frequency of monitoring. Appendix D provides instructions on water sampling, preservation and transport, field procedures, quality assurance, and analytical procedures.

4.1 [GUIDELINES] TO DETERMINE NEED AND EXTENT

The [responsible agency will determine the] need for, and extent of, post-closure ground-water detection monitoring [based upon consideration of]:

- o The nature and magnitude of present, expected, and potential impacts upon water supplies.
- o The current, expected, and potential uses of these water supplies.
- o The type of remedial action:
 - Stabilization in place, or
 - Relocation to a disposal site.
- o The nature of ground-water protection needed for the remedial action.
- o Host soil or rock hydraulic properties and boundary conditions.
- o Background water quality of potential water supplies.
- o Availability of alternate water supplies.

Potential uses of the contaminated and potentially contaminated ground water will be determined based upon the hydraulic properties, hydraulic boundary conditions, and the water quality. These factors will allow an assessment of expected yields to wells, the volume of water in storage, the recharge rates, the uses of the water without treatment, and the extent of treatment required for other uses. If the potential uses are non-existent or minimal, or if the expected uses can be supplied by alternate water resources more efficiently and economically than by the impacted or potentially impacted resources, then a monitoring network may not be needed. This determination also will be supported by consideration of the type of remedial action and the nature of the ground-water protection needed for the remedial action.

The information [(ie., reports)] required to assess the need for, and extent of, ground-water monitoring will be available in [the site file. These include] the site environmental impact statement or the site environmental assessment, the processing site characterization report or the disposal site characterization report, and the remedial action plan which includes the site conceptual design. These documents supply:

- o Documentation of current use of affected or potentially affected water supplies.
- o Predictions of expected long-term use of affected or potentially affected water supplies.
- o Present and historical concentrations of contaminants.
- o Rates and directions of contaminant migration.
- o A model of the site-specific geohydrologic setting considering water quality, ground-water hydraulics, geochemistry, climatology, and geomorphology.
- o Predictions of expected and potential contaminant migration, considering the effect of the remedial action and expected and potential changes in the local geohydrology.
- o Locations and completion details of previously installed monitor wells.

Based upon these [factors] monitoring will be considered for:

- o Disposal sites for relocated tailings and other contaminated materials.
- o Processing sites where tailings and other contaminated materials have been stabilized in place.
- o Residual contamination at and surrounding processing sites.

Based upon the [guidelines] of Section 4.1, if a primary monitoring network is needed, generally a minimum of two wells will be used for detection monitoring purposes in the simplest hydrogeologic setting for the disposal sites. One well will be placed at the upgradient toe or face of the site (Figure 4.1a). For stabilization at a processing site, an additional well upgradient and an additional well downgradient generally would be needed to monitor residual contamination that may affect ground-water quality on the site, but not from the stabilized pile. One upgradient well will be just beyond the boundary of residual contamination. Water extracted from this well would represent background quality. The second upgradient well will be installed at the upgradient toe or face of the site. Samples from this well would represent water affected by residual contamination, but not affected by post-remedial action seepage. The quality of samples from this well will be compared to the quality of water taken from a well placed at the downgradient toe or face of the site. This downgradient well will be affected by residual contamination and seepage from the site, if any occurs. This second downgradient well will be installed either at the boundary of the site or just beyond the boundary of residual contamination. In some cases, hydrogeologic boundary conditions may preclude the need for this well. This well will be used to detect off-site contaminant migration. Water-quality samples taken from this well will be compared to the water quality from the background well (furthest upgradient) (Figure 4.1b).

DIRECTION OF
HYDRAULIC
GRADIENT

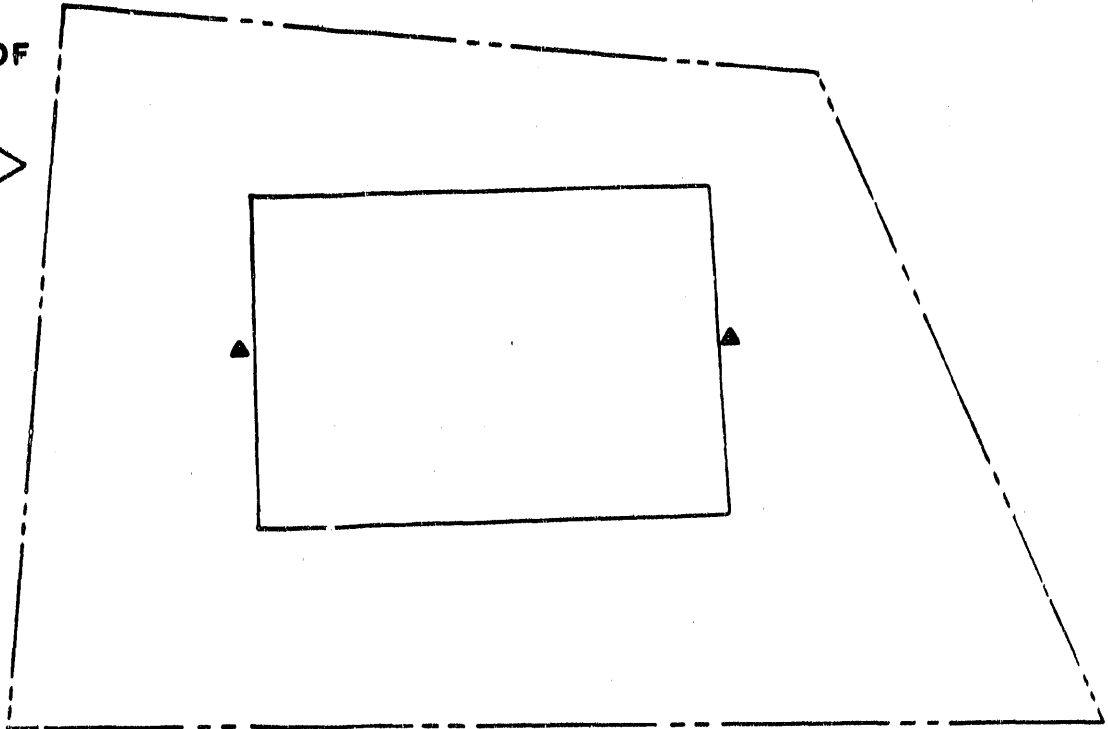
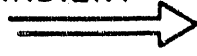

(A) DISPOSAL SITE

DIRECTION OF
HYDRAULIC
GRADIENT

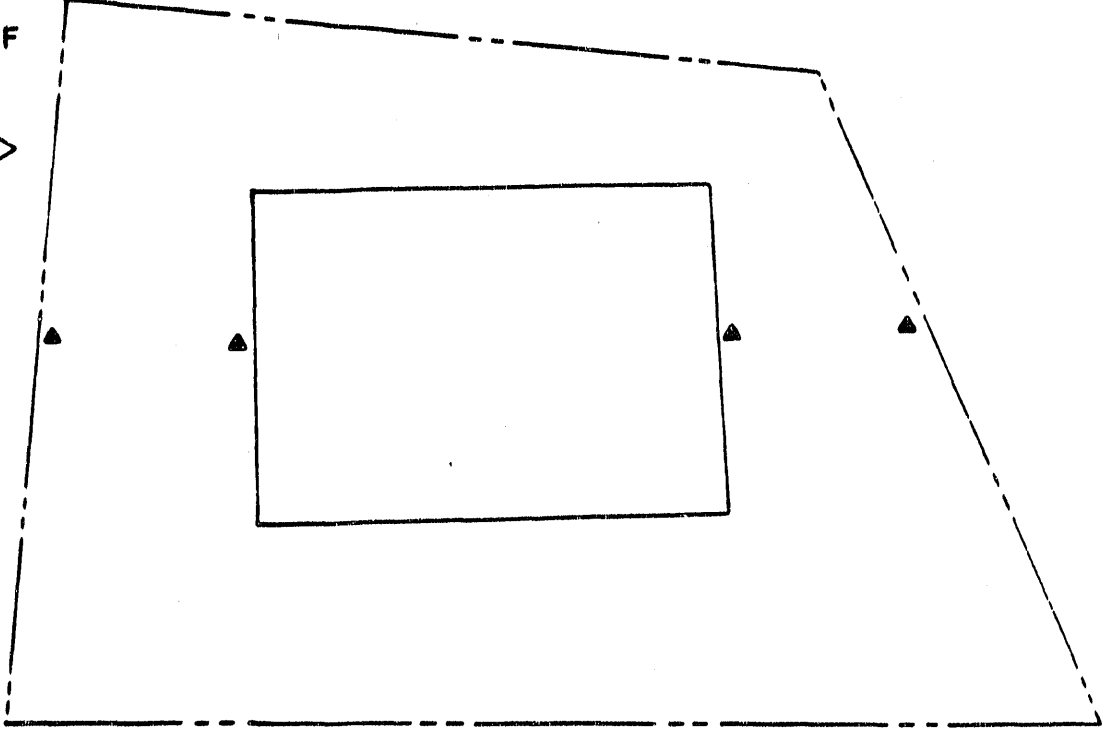
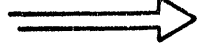

(B) STABILIZATION AT PROCESS SITE

LEGEND

- SITE BOUNDARY
- REPOSITORY BOUNDARY
- ▲ MONITOR WELL LOCATION

FIGURE 4.1
GROUND-WATER MONITORING
FOR UNIFORM, HOMOGENEOUS,
ISOTROPIC CONDITIONS

If more complex and varied hydrogeologic conditions are encountered, additional monitoring wells may be needed to ensure detection of contaminant migration (i.e., detection monitoring). For highly stratified conditions, these wells probably would consist of two or four nests of wells completed at depths corresponding to the most permeable zones (i.e., preferential seepage pathways) (Figure 4.2). For laterally heterogeneous or anisotropic conditions, these wells probably would be in two or four lines perpendicular to the expected flow direction (Figures 4.3 and 4.4). The locations of the nests or lines of wells would be at the upgradient and downgradient face of the stabilized pile and the upgradient and downgradient limit of the site boundary or just beyond the downgradient boundary of residual contamination. Also, additional monitoring wells may be needed if a major water supply has been, or may be, contaminated.

4.2 BACKGROUND AND BASELINE GROUND-WATER QUALITY

Background water quality is defined as the representative water quality after completion of remedial action from a given hydrogeologic unit that has not been impacted by past or present activities at the mill site, or, if impacted by past activities, no longer exhibits the impacts. Baseline water quality is defined as the representative water quality from a given hydrogeologic unit that has been impacted by past or present activities at the mill site and is not likely to be affected in the future.

As discussed in Section 4.1, background and baseline conditions will be identified to adequately develop a detection monitoring program at and around a processing site. To sufficiently define background and baseline conditions, quarterly samples will be collected at each monitoring well in the primary network for one year. These samples will be analyzed for the list of constituents provided on Table 4.1 [for at least two quarters. Some constituents may be eliminated for further analysis if they are not detected at all or most wells in the first two analyses.] Specific conductance, pH, water temperature, total alkalinity, and water level at the time of sampling will be measured and recorded in the field on the Ground-Water Sampling Record (Figure 4.5). If additional wells from the secondary network are available, static water levels will be measured at these wells and recorded on the Static Ground-Water Level Record (Figure 4.6). In addition, each sample will be split and the split analyzed for the detection monitoring constituents. Generally, the detection monitoring constituents will be total dissolved solids, uranium, and the major ions (sodium, potassium, calcium, magnesium, sulfate, chloride, total alkalinity, and [nitrate]).

The detection monitoring constituents were chosen for three reasons:

- o Uranium and sulfate are the most likely indicators of seepage from a site into the adjacent ground water.
- o The major ions will allow an understanding of the nature of significant changes to the local geochemistry and water quality.
- o Analysis of all the major ions will allow a quality check on each sample (i.e., the cation/anion balance).

DIRECTION OF
HYDRAULIC
GRADIENT

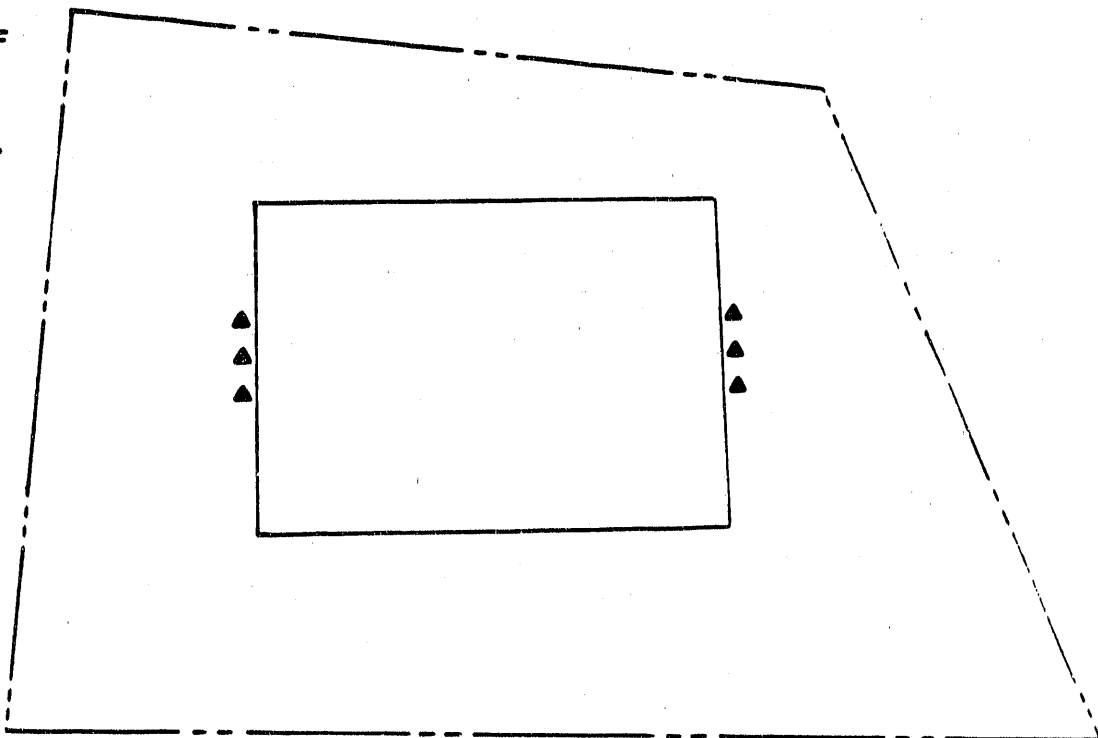
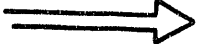

(A) DISPOSAL SITE

WELL CLUSTERS COMPLETED AT VARIOUS DEPTHS

DIRECTION OF
HYDRAULIC
GRADIENT

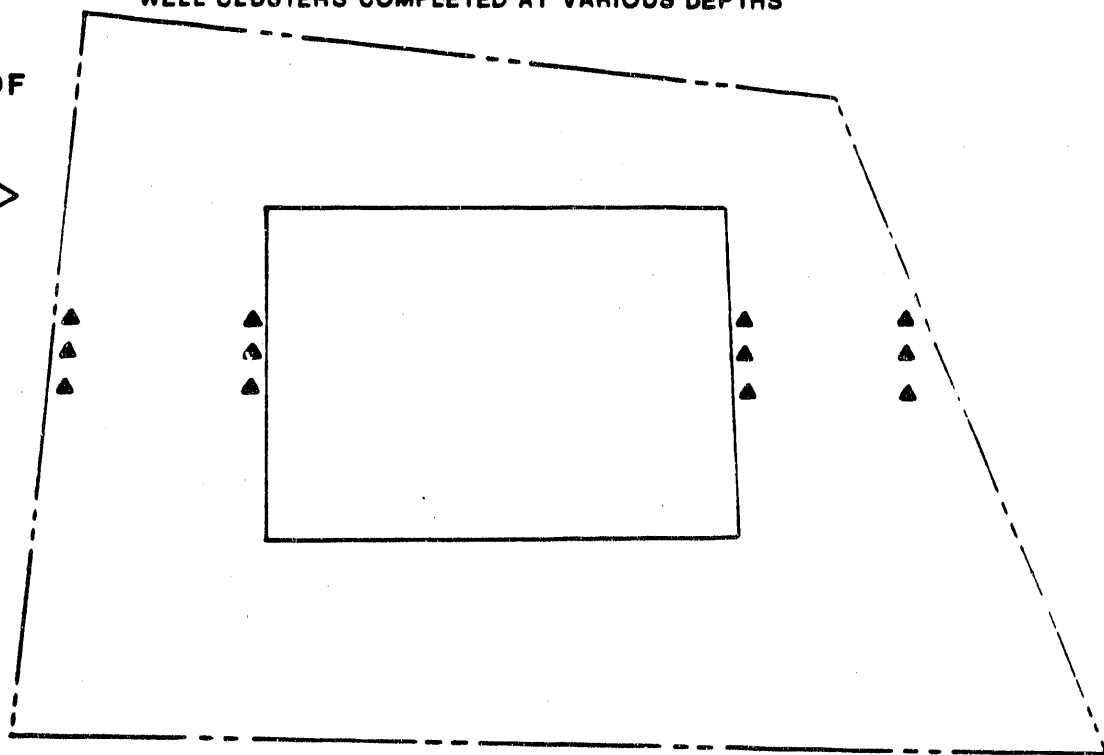
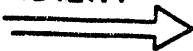

(B) STABILIZATION AT PROCESS SITE

LEGEND

- SITE BOUNDARY
- REPOSITORY BOUNDARY
- ▲ MONITOR WELL LOCATION

**FIGURE 4.2
GROUND-WATER MONITORING
FOR HIGHLY STRATIFIED CONDITIONS**

DIRECTION OF
HYDRAULIC
GRADIENT

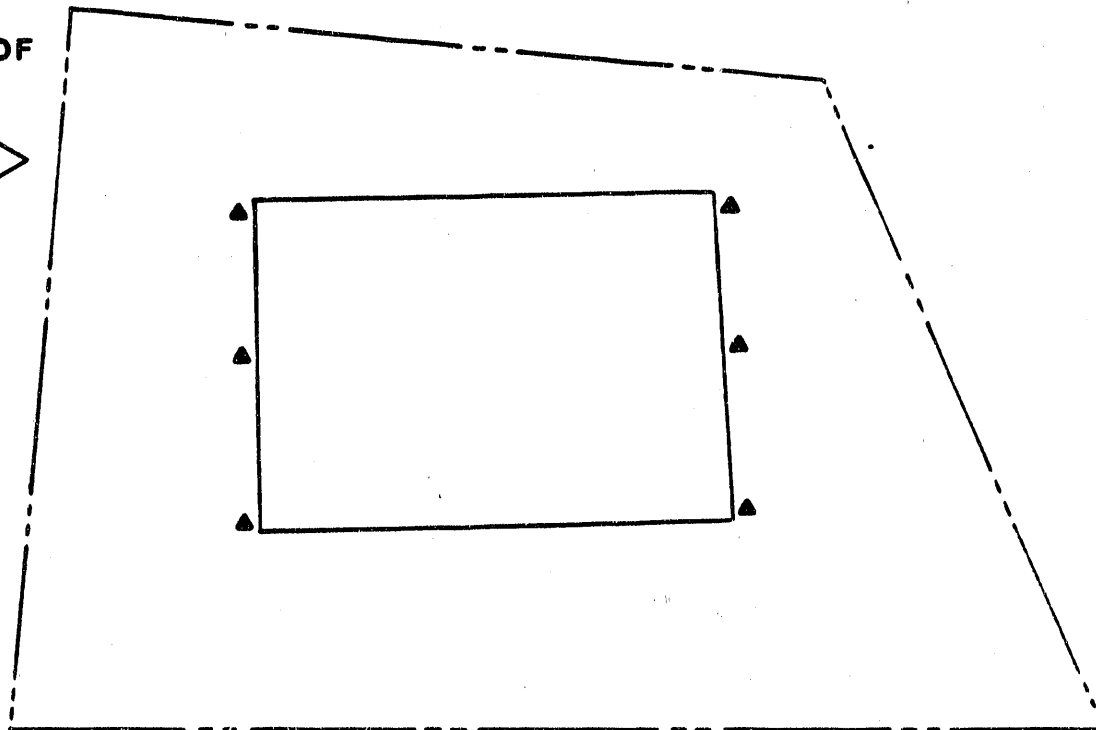
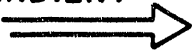

(A) DISPOSAL SITE

DIRECTION OF
HYDRAULIC
GRADIENT

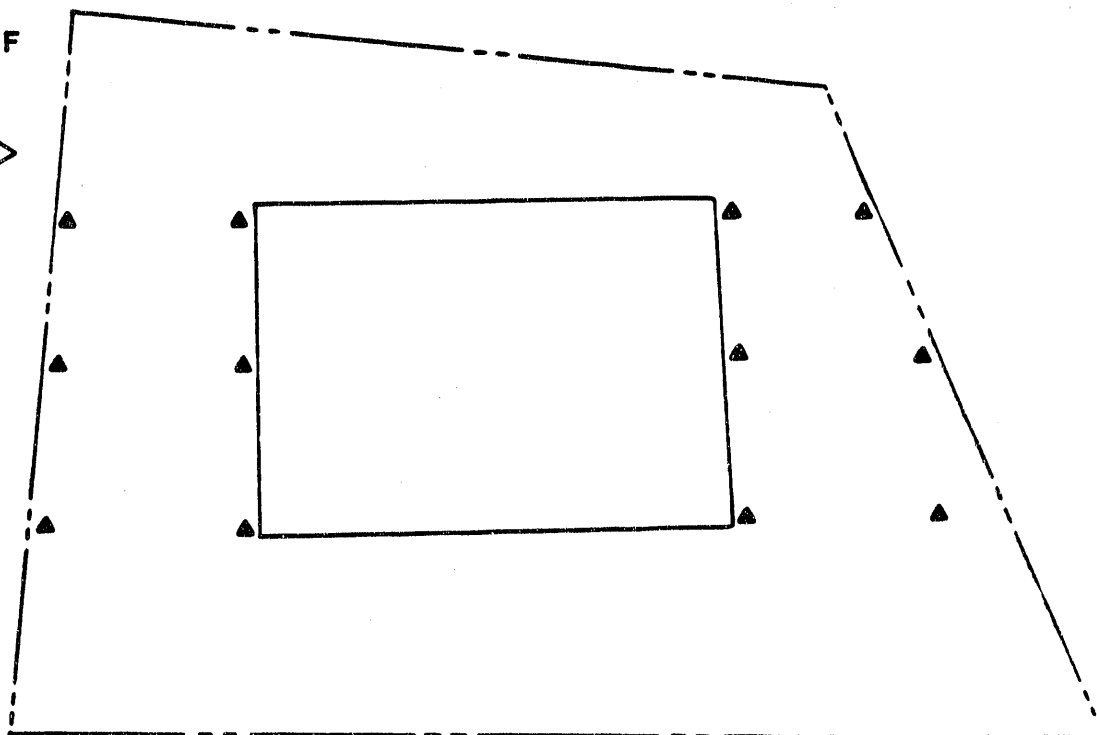
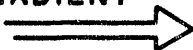

(B) STABILIZATION AT PROCESS SITE

LEGEND

- SITE BOUNDARY
- REPOSITORY BOUNDARY
- ▲ MONITOR WELL LOCATION

FIGURE 4.3
GROUND-WATER MONITORING
FOR HETEROGENEOUS CONDITIONS

DIRECTION OF
HYDRAULIC
GRADIENT

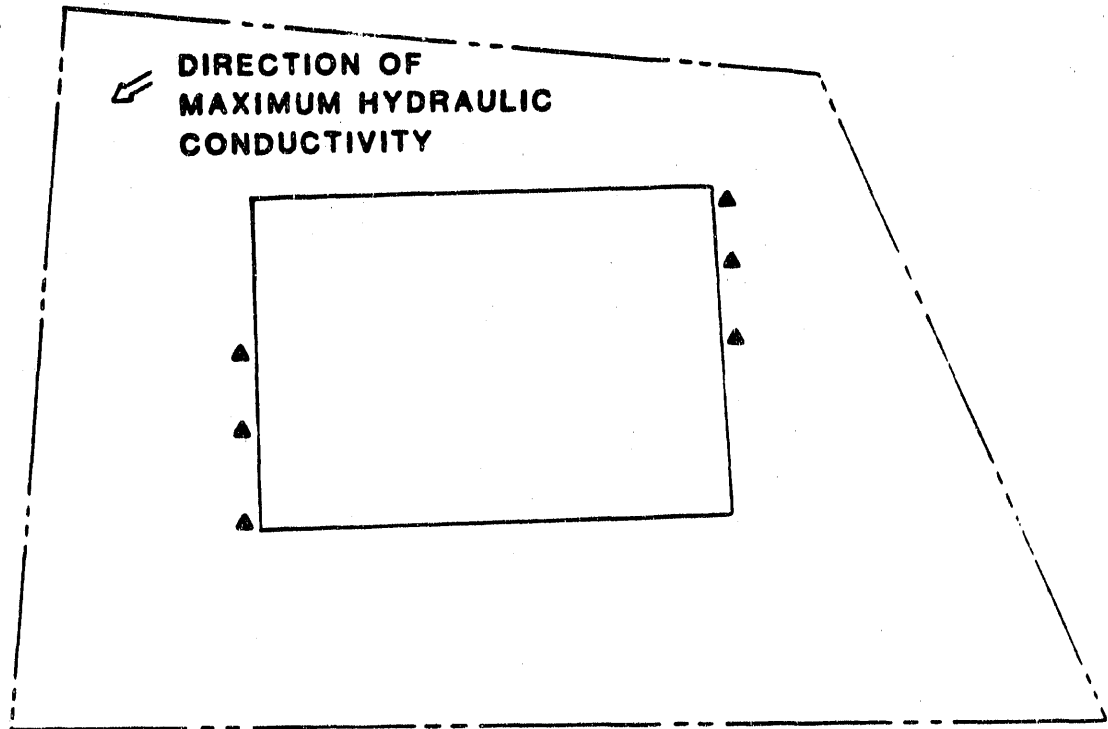
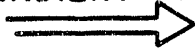

(A) DISPOSAL SITE

DIRECTION OF
HYDRAULIC
GRADIENT

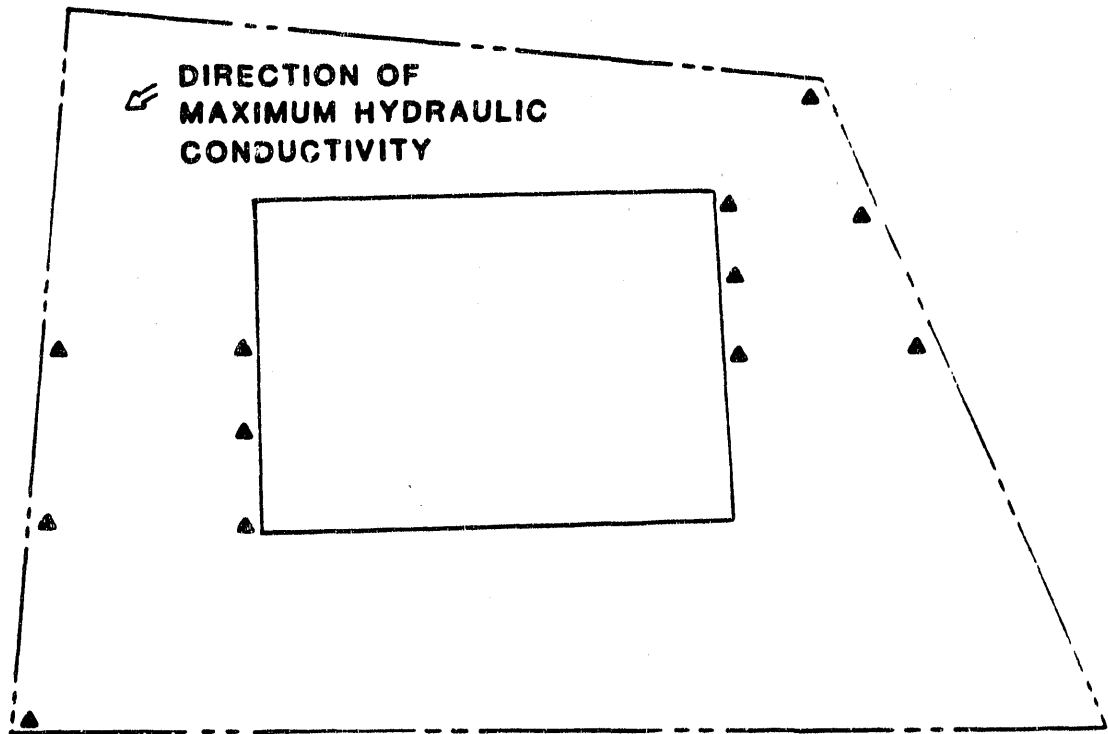
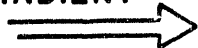

(B) STABILIZATION AT PROCESS SITE

LEGEND

- SITE BOUNDARY
- REPOSITORY BOUNDARY
- ▲ MONITOR WELL LOCATION

FIGURE 4.4
GROUND-WATER MONITORING
FOR ANISOTROPIC CONDITIONS

Table 4.1 Background, baseline, and compliance monitoring constituent list

Constituent	Detection limit (mg/l)	Constituent	Detection limit (mg/l)
Chloride (Cl)	1.0	Copper (Cu)	0.02
Sulfate (SO ₄)	0.1	Iron (Fe)	0.03
Sodium (Na)	0.002	Lead (Pb)	0.01
Potassium (K)	0.01	Manganese (Mn)	0.01
Magnesium (Mg)	0.001	Mercury (Hg)	0.0002
Calcium (Ca)	0.01	Molybdenum (Mo)	0.01
Boron (B)	0.1	Nickel (Ni)	0.04
Fluoride (F)	0.1	Selenium (Se)	0.005
Cyanide (CN)	0.01	Silver (Ag)	0.01
Hydrogen Sulfide (H ₂ S)	0.1	Strontium (Sr)	0.1
Ammonium (NH ₄)	0.1	Tin (Sn)	0.005
Nitrite (NO ₂)	0.1	Uranium (U)	0.003
Nitrate (NO ₃)	1.0	Vanadium (V)	0.01
Silica (SiO ₂)	2.0	Zinc (Zn)	0.005
Phosphate (PO ₄)	0.1	Total Dissolved Solids (TDS)	10
Aluminum (Al)	0.1	Total Organic Carbon (TOC)	0.1
Antimony (Sb)	0.003		
Arsenic (As)	0.01	<u>Radionuclides</u>	<u>pCi/l</u>
Barium (Ba)	0.1	Lead-210 (Pb-210)	1.5
Cadmium (Cd)	0.001	Polonium-210 (Po-210)	1.0
Chromium (Cr)	0.01	Radium-226 (Ra-226)	1.0
Cobalt (Co)	0.05	Radium-228 (Ra-228)	1.0
		Thorium-230 (Th-230)	1.0

FIGURE 4.5
GROUND-WATER SAMPLING RECORD

Page 1 of 3

SITE ID: _____ LOCATION ID: _____ SAMPLE ID: * _____ STATIC WATER LEVEL (FT) _____ SAMPLE DEPTH (FT) _____ SAMPLING DATE _____ SAMPLING TIME: START _____ COMPLETE _____	FINAL FIELD VALUES: pH (S.U.): _____ Ec (umhos/cm) _____ Eh (millivolts) _____ TEMP. (°C): _____ ALKALINITY (mg/l CaCO ₃): _____ LOCATION DESCRIPTION _____	IN-SITU DIS- PLACED
--	---	---------------------------

	CONTAINER SIZE	NONACIDIFIED (no.)	ACIDIFIED (no.)	VOL. ACID (ml)
NUMBER OF CONTAINERS COLLECTED:	ONE-LITER	_____	_____	_____
	150 ml	_____	_____	_____
	50 ml	_____	_____	_____
SPECIFY OTHERS:	_____	_____	_____	_____
	_____	_____	_____	_____
	_____	_____	_____	_____

COMMENTS: _____

FIELD REP (S): _____

DATE	TIME	TOTAL VOLUME WITHDRAWN		pH	Ec (umhos/cm)	TEMP. (°C)	COMMENTS
		(Gals)	(Bore Volumes)				
		0.0	0.0	-	-	-	START PUMPING

**FIGURE 4.5 (CONT.)
GROUND-WATER SAMPLING RECORD**

BORE VOL CALCULATION

$$(d/2)^2 \pi (h_1 - h_2)$$

SAMPLING INFORMATION

DEPTH TO WATER (h_2) (FT.) _____	WITHDRAWAL METHOD _____
DEPTH OF WELL (h_1) (FT.) _____	SAMPLING METHOD _____
WELL DIA (FT.) _____	FILTER SIZE _____
BORE VOL. (FT.) ³ _____	THERMOMETER ID _____
DEPTH TO SCREEN (FT.) _____	E _c METER ID _____
	WELL SOUNDER ID _____
	PUMP ID _____

CALIBRATION INFORMATION

DATE/TIME OF LAST E_c CALIBRATION _____

TIME OF pH CALIBRATION _____

pH AFTER MEASUREMENT _____ FOR STANDARD pH _____

pH AFTER MEASUREMENT _____ FOR STANDARD SOLUTION pH _____

E_h OF CALIBRATING SOLUTION _____

E_h READING IN CALIBRATING SOLN. AFTER MEASUREMENT _____

TEMP. OF CALIBRATION SOLN. (°C) _____

SHIPPING INFORMATION

LAB(S) SHIPPED TO: _____

DATE(S) SHIPPED: _____

METHOD OF SHIPMENT: _____

NOTES:

Other constituents may be added if supported by site-specific water quality and geochemistry. In addition, the well-to-well results will be compared; these results will also be compared to water-quality sampling results prior to remedial action. These results and analyses will be recorded (Figure 4.7) and will become part of the site file.

In addition to background and baseline water quality, background and baseline soil and rock chemical quality and baseline well hydraulics [may] be [characterized if determined to be important for a given site. In such a case,] elutriations with deionized water of representative soil and rock core samples will be assessed for chemical quality to determine the concentration of water soluble contaminants remaining in the soil or rock at the various locations and depths analyzed. These samples will be analyzed for the set of constituents on Table 4.1. The data will be recorded on the Soil/Rock-Quality Analytical Results (Figure 4.8). [These data will be used to evaluate whether elevated concentrations in water samples have resulted from seepage from the repository or residual contamination released to the water from soil or rock outside the site.]

Baseline well hydraulics will be identified with three slug tests on each monitor well in the primary network. The data from each test will be analyzed with at least two methods. The data and results will be displayed on Figure 4.9 (Slug Test Data). [These data will be used to estimate the hydraulic properties of the aquifer and monitoring wells which may be useful information for refining monitor well placement and sampling procedures.]

4.[3] DATA ACCEPTABILITY AND STATISTICAL PROCEDURES

As part of the procedures to validate the data, the cation/anion balance will be calculated and recorded for each sample result. An acceptable sample will have an error less than plus or minus [five] percent. If unacceptable sample results are reported, either the samples will be reanalyzed to acceptable limits or additional samples will be collected and analyzed to acceptable limits. [The use of split and known samples is described in Appendix D.]

[Due to the limited number of data points, statistical analyses of water-quality data can support qualitative or semi-quantitative interpretations only. Statistical analyses of water-quality data at every site will include:

- o Arithmetic means, standard deviations, and coefficients of variation for each constituent for each monitor well. For the detection constituents, eight values will be used in the calculations. For the non-detection constituents, four values will be available for these calculations.
- o Arithmetic means, standard deviations, and coefficients of variation for each constituent for each quarterly sampling set. For detection constituents, two values from each monitor well will be used. For non-detection constituents, one value from each monitor well will be used in the calculations.]

FIGURE 4.7
WATER-QUALITY ANALYTICAL RESULTS

Sheet ___ of ___

SITE ID: _____ LOCATION ID: _____ SAMPLE ID: _____

LOCATION DESCRIPTION: _____

DATE SAMPLED: _____

LAB NAME: _____ DATE REC'D: _____

LAB SAMPLE ID: _____

DATE ANALYZED: _____ CHECKED BY: _____

SAMPLE CONDITION (ON RECEIPT): _____

COMMENTS: _____

PARAMETER	RESULTS				DETECTION LIMIT		COMMENTS
	PRIMARY	UNITS	DUPLICATE	UNITS	VALUE	UNIT	

RECEIVED BY _____ DATE _____ APPROVED BY _____ DATE _____

[These statistical parameters will allow a semi-quantitative evaluation of the means and spatial and temporal variations of all the background and baseline water-quality constituents. The variations between the splits for detection constituents will be assessed but not statistically analyzed. Explanations for large variations will be sought and noted.]

4.[4] RESPONSE TO EXCURSIONS

[Excursion criteria will be established for each site. A generic definition of an excursion is not warranted in this Plan because site-specific and constituent-specific factors must be considered. These factors include:

- o Comparison of upgradient and downgradient water quality.
- o Site-specific hydrogeology.
- o Local water uses.
- o Statistical distributions of contaminant concentrations.
- o The health hazards or other detrimental effects associated with the particular constituent at specific concentrations.

When an excursion is detected, compliance monitoring will be initiated (Figure 3.1). Compliance monitoring will include:]

- o Resampling of all monitor wells.
- o Samples will be split between two qualified laboratories. One laboratory will analyze for detection constituents, and the other will analyze for the compliance constituents (Table 4.1).

Upon receipt of the results from the compliance monitoring, the responsible agency will assess the extent of the problem and determine appropriate investigations and/or mitigative measures. The nature and extent of the investigations and/or mitigative measures will be based on site-specific considerations. Several actions may be undertaken and include:

- o Installation and sampling of additional wells.
- o Evaluation of exposure pathways health risks.
- o Evaluation of need for restorative actions.
- o Evaluation of need for additional remedial action at the site.

4.[5] MONITORING SCHEDULE AND REPORTING

Following the definition of background and baseline conditions, all monitoring wells will be sampled quarterly for three years. For detection monitoring, only the detection constituents and field parameters will be assessed. The results of the detection monitoring will be reported in an annual ground-water report that will become part of the site file.

At the conclusion of three years of [detection monitoring], the responsible agency and the NRC will reassess the monitoring schedule.

[Upon identification of an excursion, the responsible agency will immediately retest to confirm the excursion. If the excursion is confirmed, the responsible agency will notify the NRC and begin compliance monitoring by submitting a preliminary assessment of the excursion and a compliance monitoring plan. Once the NRC approves the plan, the responsible agency will implement the plan's provisions. After the initial results of compliance monitoring are available, the responsible agency will perform a hydrogeologic analysis and recommend appropriate mitigative actions for review and approval by the NRC.]

Upon completion of compliance monitoring (if needed), a report will be prepared that provides the results and recommends additional mitigation. This report will also be included in the site file.

Details of reporting and recordkeeping are included in Section 7.5.

5.0 AERIAL PHOTOGRAPHY

5.1 INTRODUCTION

Periodic aerial photography flights will provide a useful photographic record of conditions at each disposal site. A combination of site inspections and aerial photography interpretation will lead to a broad understanding of the modifying processes at work at a particular disposal site.

This section describes flight planning, aerial photography specifications, and aerial photography interpretation. Appendix E contains details of quality assurance requirements for aerial photography.

5.1.1 Objectives

The objectives of aerial photography are complementary to the site surveillance objectives described in Section 3.1. Specifically, the aerial photography program will:

- o Assist the site inspectors in examining on-the-ground features.
- o Provide a permanent record of site conditions after remedial action.
- o Monitor and quantitatively measure the change in site conditions through photo interpretation.
- o Supply the basis for updating topographic maps, as necessary.

The site inspection team will use aerial photographs as an orientation tool prior to inspection of disposal sites. Photographs from previous years will be available for inspectors or aerial photo interpreters for use in comparing changes in erosion patterns, vegetation, or other modifying conditions extant at a site. The changes in land use surrounding the disposal sites will be readily monitored with the aid of aerial photography.

5.1.2 Comparison of aerial photography formats

Several general aerial photography formats will be available for use in satisfying the objectives described in Section 5.1.1. These formats include:

- o Low altitude, large-scale photography, using a metric camera and 9-inch by 9-inch film with photo negative scales ranging from 1:1200 to 1:5000.
- o Low altitude, large-scale photography, using 70mm film with photo negative scales ranging from 1:600 to 1:5000.

- o Low altitude, large-scale photography, using the EPA Enviro-pod, a camera with two panoramic lenses using a 70mm film format.

Of the three camera/film formats, the metric camera/9-inch-by-9-inch film format would best fulfill the objectives of the aerial photography program. The primary advantages of the metric camera/9-inch-by-9-inch format are: (1) revisions to topographic mapping can be made easily using 9-inch-by-9-inch contact prints, and (2) contact prints cover relatively larger areas and thus are easier to use than 70mm negatives. The prime disadvantage is that this format is relatively expensive.

In contrast, the 70mm film used in the other formats would require 5 to 16 frames to view the area included in a single 9-inch by 9-inch negative (assuming the scales are the same). The cost of photography acquisition would probably be 20 to 30 percent lower for the 70mm film format due to the use of smaller aircraft, non-permanent camera mounts, and the lower cost for film and processing. A skilled photo interpreter would be able to interpret either 70mm or 9-inch by 9-inch stereo photographs with similar precision.

5.2 FLIGHT PLANNING AND AERIAL PHOTOGRAPHY SPECIFICATIONS

5.2.1 Color infrared stereo contact prints

A set of color, infrared stereo contact prints and a set of natural-color, high oblique prints (double-weight glossy paper) will be produced during the aerial photography acquisition phase of the program (Table 5.1). An index map showing the flight lines and frame numbers will also be prepared.

The color infrared photographs will have a negative scale of 1 inch = 100 feet (Representative Fraction [RF] 1:1200) in a 9-inch-by-9-inch format. This can best be accomplished by using a camera with a 12-inch focal length at 1200 feet above ground level. Each set of photographs will have 60 percent end overlap and 30 percent average side overlap. Eastman-Kodak Aerochrome Infrared 2443 film will be used in conjunction with a Wratten No. 12 or No. 15 filter. A metric, aerial photography camera will be mounted on an aircraft platform suitable for low-level flight.

5.2.2 Low oblique photographs

Low oblique photographs will be taken with exposures framed so that each site and several hundred feet surrounding each site are within each frame. A high resolution, natural-color negative film will be used (e.g., Eastman-Kodak Aerocolor Negative Film 2445) in a 35mm or larger format. The photographs will be taken from a minimum of two different angles with no less than 90° rotation (e.g., view toward the east and view toward the north). If 35mm or 70mm film is used, deliverable products will be a set of 8-inch-by-10-inch glossy, double-weight prints. Contact prints will be acceptable if a 9-inch-by-9-inch format is used.

Table 5.1 Aerial photography specifications

LOCATION: UMTRA Project final disposal site plus [a minimum of] 0.25 mile beyond site boundaries.

PRODUCTS TO BE DELIVERED:

1 set of contact prints 9-inch by 9-inch, scale 1 inch = 100 ft (RF 1:1200).

Double weight, glossy, not trimmed.

1 index map -- scale 1 inch = 1000 ft.

1 set of low oblique photographs in natural color. Enlargements of 35mm or 70mm negatives will be acceptable.

FLIGHT DATE: Mid to late summer, at peak of photosynthetic response of vegetation, unless the flight is to be used exclusively for topographic mapping.

CAMERA: Precision, 9-inch by 9-inch format for vertical photos. 35mm (single lens reflex) or larger format camera for oblique photos.

FILM: Eastman-Kodak Aerochrome Infrared 2443 for vertical photos. Eastman-Kodak Ektacolor or equivalent for oblique photos.

FILTER: Wratten No. 12 or Wratten No. 15 for infrared photos. Skylight filter for color photos.

FLIGHT LINE COVERAGE: 60 percent end overlap; 30 percent average side overlap.

GROUND CONTROL: Control stations will be second order Class I for horizontal control and third order for vertical control.

5.2.3 Timing of aerial photography flights

Aerial photography flights will be scheduled for mid- to late summer, when vegetation is at peak infrared response. The optimal season will vary from site to site. The date of photography is not as important for sites where rock has been used for the final cover because vegetation on rock covered sites will not need as careful evaluation for shrubs as will the revegetated sites during the early years of surveillance. Since the sites will not be revegetated with deciduous trees, avoiding the leafless season is not important. Cloudless days will be selected for aerial photography flights.

Aerial photography flights will be scheduled immediately after remedial action, at year 3, and at year 8. The need for additional aerial photography and the schedule of flights will be assessed by the responsible agency at year 10.

5.3 AERIAL PHOTOGRAPHY INTERPRETATION

Examination of the aerial photographs by skilled photo interpreters will provide a valuable record of information. Identification of surface features will be accomplished by utilizing existing photo interpretation keys, judgement of the experienced interpreter, and by developing new photo interpretation keys for specific sites.

5.3.1 Use of existing photo interpretation keys

Interpretation keys have been developed for identifying shrub species, percent vegetation cover, and erosional features. However, existing keys probably will not be adequate or appropriate for use at all sites because of ecological and geomorphic variations between the disposal sites and areas that have been previously studied. Therefore, at each site the photo interpreter utilized by the responsible agency will evaluate existing keys to determine their suitability for use at any of the disposal sites. Some keys that have been developed which may be useful are provided in Table 5.2.

5.3.2 Development of photo interpretation keys

Photo interpretation keys will be developed by the responsible agency for each site or group of similar sites during the first year of aerial surveillance. Procedures for developing keys are outlined in publications by Eav et al. (1981), Carnegie and Reppert (1969), and Tueller (1979). The best approach in developing new keys is to visit each site or representative features near by each site prior to the initial flight and mark features that are identifiable. Usually, wooden laths or stakes painted white are placed on the ground pointing to the object to be identified. A circular, numbered marker (about 10 inches in diameter) is

Table 5.2 Photo interpretation keys and aids

Publication	Remarks
Manual of Photographic Interpretation (ASP, 1960)	Forest, rangeland, and engineered features.
Manual of Remote Sensing (ASP, 1968)	Forest, rangeland, and engineered features.
Photo Interpretation Key for Pine Regeneration Analysis (Eav et al., 1981)	The plant species described are not common to any of the disposal sites, but the technique for developing a new key is useful.
Color for Shrubs (Driscoll and Coleman, 1974)	A good dichotomous key for shrubs in semi-arid sites in Colorado.
Some aspects of the use of dichotomous keys to aid in the interpretation of color aerial photographs for vegetation mapping (Tueller, 1979)	
Large-scale color photography for erosion evaluations on rangeland watersheds in the Great Basin (Tueller and Booth, 1974)	A useful reference for identification of erosional features.

placed near the object. After the aerial photos have been processed, the distinctive characteristics of target objects are described with accompanying representative photographs.

Characteristics useful in identifying features include tone, texture, contrast, color, linear alignments, shape, and shadow height.

5.3.3 Qualifications for photo interpreters

At a minimum, photo interpreters will have university level training in aerial photo interpretation. Courses of study must include geomorphology, environmental geology, plant taxonomy, and range management. Additional areas of study that are desirable include photogrammetry, remote sensing, fluvial hydrology, and soils engineering. A degree in geology, geography, biology, range science, or civil engineering is also desirable. Work experience in appropriate disciplines will be acceptable as a substitute for some of the university level training.

Two photo interpreters will evaluate the aerial photographs. One interpreter will have special expertise in identifying erosional and structural features. The other will be proficient in plant identification and vegetation analysis.

5.3.4 Identification and recordation of features

The features to be identified and the estimated ease of identification are listed on Table 5.3. To assure that features do not go undetected, Table 5.3 will be used as a checklist when the photo interpreter reviews each photo.

Signatures of features will be recorded on an overlay to the site map. Each erosional feature (e.g., rill, gully), will be assigned an alpha-numeric designation. Measurements of erosion features also will be recorded in tabular form for ease of comparison.

Some features will be counted and classified according to size and density (e.g., number of animal burrows per site or per acre, or number of rills having a width of three inches or less). These data will be summarized and tabulated.

Identification of gully erosion and stream channel migration will be facilitated because of the distinctive shadows cast by these features. Sheet erosion, flood debris, slope failure, wind erosion (blowouts), animal burrowing, and riprap weathering can best be identified by color variation, tone, and texture. Small cracks in soil cover due to desiccation, differential settling, or piping will be difficult to detect until cracks become larger than one inch in width. Condition of vegetation cover will be readily assessed by evaluating the infrared response (red color). Identification of shrub species will be useful in determining the need

Table 5.3 Comparison of feature identification (ease of detection)

Surface feature	Aerial photography (1 in = 100 ft)	Topographic map (1 in = 50 ft)	Field inspection
Gully erosion	1	2	1
Sheet erosion	2	3	2
Piping	3	4	2
Flooding	2	3	1
Wind erosion (blow outs)	2	4	2
[Wind deposition	3	3	2]
[Ground fractures and faults	2	4	3]
[Soil/rock mass movement	2	3	1]
Cover shrinkage	3	4	3
Chemical attack of cover	4	4	3 - 4
Differential settlement			
Soil and vegetation cover	2	3	1
Riprap cover	3 - 4	3 - 4	3
Slope failure			
Soil and vegetation cover	1	3	1
Riprap cover	2	3	2
Diversion channel obstruction	1	2	1
Stream channel migration	1	2	2
Shrub and tree root penetration	4	4	3
Shrub and tree encroachment	1	4	2
Animal burrowing	1	4	1
Revegetation failure	1	4	1
Riprap weathering	3 - 4	4	2
Rise in water table	2	4	1
Human intrusion	1 - 2	3	1
Fence and sign damage	2	4	1
Contaminant releases to ground water	4	4	4

KEY: Ordinal ranking

- 1 = Easiest
- 2 = Less easy
- 3 = Difficult
- 4 = Cannot be identified

for removal of deep-rooted species. Tap roots from some shrubs are suspected of being one mechanism of failure in the radon attenuation cover. Intrusions by man may be more difficult to recognize unless they involve removal of soil or rock from the site. Tire tracks and fence damage can be determined by photo interpretation. Shadows cast by fence posts will be readily detectable at the recommended scale.

6.0 CUSTODIAL MAINTENANCE AND CONTINGENCY PLANS

6.1 INSTITUTIONAL PROCEDURES

This section explains the procedures to be used by the responsible agency to determine when maintenance or contingency repairs are required at a tailings disposal site. The relationship of events in the surveillance and maintenance process is shown in Figure 3.1. In general, the decision to conduct maintenance or contingency repair will be based on the results of Phase II or contingency site inspections, or compliance monitoring, the milestones in the process at which site problems are assessed. At some sites, conditions requiring regularly scheduled custodial maintenance can be anticipated and planned accordingly (e.g., mowing of the grass cover at the Canonsburg, Pennsylvania site). Most sites, however, will not require scheduled maintenance.

6.2 SITE CONDITIONS REQUIRING MAINTENANCE OR REPAIR

The responsible agency will decide whether or not to initiate custodial maintenance or contingency repair (Step 8 in Figure 3.1). Examples of site conditions that may require maintenance are listed in Table 6.1. Conditions that may trigger contingency repair action are listed in Table 6.2.

When compared with contingency repair, maintenance is expected to be generally less costly, smaller in scale, and more frequent in occurrence. In contrast, contingency repairs are very unlikely to be needed; however, repair costs may be substantial due to the size of the work force and technical skills required for repairs.

6.3 MAINTENANCE AND CONTINGENCY REPAIR ACTION

Inspection reports and monitoring results will be reviewed and site conditions will be compared from year to year so that trends of changing conditions can be determined. Extrapolation of identifiable trends will provide a means of predicting when maintenance or repair will be needed at disposal sites.

After a decision has been made by the responsible agency to initiate maintenance or contingency repair, a statement of work will be prepared for the work to be performed (Step 9 in Figure 3.1). The maintenance or repair action required to correct a site problem will be dependent upon the nature of the problem or hazard at a disposal site. Although the details of maintenance or repair actions that may be needed cannot be reliably predicted in advance, the range of possible actions have been outlined in Table 6.3.

6.4 NOTIFICATION TO AFFECTED PARTIES

A remote possibility exists for failure of a site to adequately contain the tailings (Step 6 in Figure 3.1). Two possible scenarios are:

Table 6.1 Examples of site conditions that may require custodial maintenance

-
1. Damage to site boundary fence, signs, or monuments.
 2. Damage or obstruction to primary site access road (e.g., road washout at a ravine or arroyo, or new construction adjacent to the site that obstructs the access road).
 3. Growth of deep-rooted shrubs on the site cover.
 4. Development of animal burrows on the site cover.
-

Table 6.2 Examples of site conditions that may require contingency repair

-
1. Development of rills or gullies, deeper than six inches with near vertical walls and no vegetative cover.
 2. Surface rupture where the dimensions of the cracks are larger than one inch wide by ten feet long by one foot deep which would indicate severe shrinkage of cover materials or differential settlement of site materials.
 3. Instability of slopes to the point where mass wasting or liquefaction has occurred due to earthquakes, differential settlement, or other causes.
 4. Encroachment of stream channels or arroyos onto the disposal site.
 5. Flood damage to the disposal site in the form of new channels, or debris deposits.
 6. Intrusion by man whereby cover materials have been removed from the site.
-

Table 6.3 Custodial maintenance or repair actions which could be needed at sites

1. Repair of fences.
 2. Replacement of warning signs.
 3. Reestablishment of survey control monuments.
 4. Removal of deep-rooted shrubs from the embankment cover.
 5. Control or eradication of burrowing animals.
 6. Placement of fill in gullies or rills.
 7. Replacement of erosion barrier rock cover materials.
 8. Placement of inclinometers or tilt meters to measure movement on unstable slopes.
 9. Reconstruction of embankment slope segments where slumping, mass wasting, liquefaction, or other severe events have occurred.
 10. Reconstruction of site cover or other features because of river encroachment, extreme seismic events, extreme flooding, or other events.
-

- o Significant movement of highly contaminated leachate into ground-water sources of drinking water.
- o Release of tailings from a site following a major earthquake, major flood, or other severe natural phenomena.

The responsible agency will become aware of site failure in at least three ways:

- o Results of Phase I, Phase II, or contingency site inspections.
- o Reports from local government authorities or local residents.
- o Reports from NOAA, the Earthquake Early Warning Service, or other agencies.

On the basis of the site contingency plan, appropriate action will be taken by the responsible agency to notify individuals who may be affected and advise them of precautions that should be taken. Local law enforcement officials, news media, responsible agency representatives, NRC representatives, or state/Indian tribe representatives may be utilized in contacting affected parties.

6.5 CERTIFICATION OF MAINTENANCE OR CONTINGENCY REPAIR

After completion of maintenance or contingency repair actions, the responsible agency will certify that all work was completed in accordance with specifications. Certification will consist of review of modified as-built drawings and site inspection, and review of a report followed by a written statement declaring the repair or maintenance to be acceptable and within compliance of the NRC license for the site. Copies of the certification statement will be attached to the NRC site license, the site inspection report, and will become part of the site file.

7.0 REPORTING AND RECORDKEEPING

7.1 INTRODUCTION

Carefully compiled, complete, accurate reports of site surveillance and maintenance activities will be maintained in a manner to ensure their long-term survival. Reports and records will:

- o Provide the responsible agency and the NRC with the information necessary to forecast future site surveillance and maintenance.
- o Provide information that will be available to the public that will demonstrate that site integrity has been maintained.
- o Demonstrate to the NRC that license provisions continue to be met.

Archival procedures for records will be those set forth in the Code of Federal Regulations; Title 41, Public Contractors and Property Management; Chapter 101, Federal Property Management Regulations; Subchapter B, Archives and Records; Section 101-11, Records Management (41 CFR 101-11). This information can also be made available to the public.

As noted in Section 1.3 as well as in the Project Licensing Plan (DOE, 1984a), the DOE will be the responsible agency for all sites until 1990. After 1990, responsible agency authority will be assigned by the President to either the DOE or another Federal agency. In either event, the responsible agency will manage and conduct surveillance, custodial maintenance, and contingency repair actions pursuant to the license requirements of the NRC.

The responsible agency will provide an annual report to the NRC that summarizes, describes, and evaluates all surveillance and maintenance actions and certifies that site license requirements continue to be met. A copy of all inspection, monitoring, maintenance, and contingency repair reports for the reporting period will be appended to the report. Discussed in the following sections are reporting and recordkeeping requirements for each component of this plan.

[7.2 SITE FILE

A site file will be maintained by the responsible agency. A site file will contain all of the information necessary to prepare for, and conduct, site surveillance and maintenance. At a minimum, a site file will include:

- o Environmental impact statement or environmental assessment.
- o Remedial action plan/site conceptual design.
- o Processing site characterization report or disposal site characterization report.
- o Final certification report.
- o Final site condition records.
- o Site inspection records and reports.
- o Ground-water monitoring records and reports.
- o Aerial photography and interpretive reports.
- o Maintenance and contingency repair records and reports.]

- [o License.
- o As-built drawings.
- o Site atlas.]

7.[3] FINAL SITE CONDITION[S]

Final site condition records will consist of the following documents:

- o As-built drawings.
- o Construction and baseline photographs (see Section 2.2).
- o Baseline data maps (see Section 2.3).
- o Site aerial photographs (see Section 2.4).
- o Site atlas (see Section 2.5).
- o Locations of monuments, site markers, and signs (see Section 2.6).
- o Location of monitoring wells (see Section 2.7).
- [o Location of settlement plates and other surveillance features (see Sections 2.8 and 2.9).]

7.[4] SITE INSPECTION

7.[4].1 Records

Site inspection records will consist of:

- o Phase I inspection reports.
- o Phase II inspection reports.
- o Contingency inspection reports.
- o Letters and documents pertaining to the appointment, qualifications, and training of inspectors.
- o Letters and documents commenting on and analyzing inspection reports.
- o Letters and documents directing maintenance and contingency repair actions as a result of site inspections.
- o Other site inspection related documents as deemed appropriate by the responsible agency.

All site inspection records will be kept current in the site file by the responsible agency for a minimum of five years except for inspection reports. The inspection reports will be kept for a minimum of 10 years in the site file. At the end of the specified retention period, the inspection records will be microfiche (or equivalent) and stored in the archives of the responsible agency.

7.[4].2 Reports

There are three types of site inspection reports:

- o Phase I inspection reports. A Phase I inspection report will consist of: the completed inspection checklist, including narrative and rationales, resumes of inspectors, photo logs, field notes, and sketches; annotated site atlas overlays; site photographs; and inspection reports of maintenance.
- o Phase II inspection reports. A Phase II inspection report will consist of the inspector's written report and accompanying data concentrating on those potential problems raised in the Phase I inspection. The emphasis in the report will be on conclusions and recommended additional studies and mitigative measures.
- o Contingency inspection report. This report will document the conditions at the site, determine whether an imminent hazard exists, and provide recommendations for repair and notification to affected parties.

7.[5] GROUND-WATER MONITORING

7.[5].1 Records

All data will be recorded on standard forms. These forms include:

- o Borehole/well construction log (Figure 2.6).
- o Well completion record (Figure 2.7).
- o Borehole log[s] (Figure[s] 2.8 [and 2.9]).
- o Ground-water sampling record (Figure 4.5).
- o Static ground-water level record (Figure 4.6).
- o Water-quality analytical results (Figure 4.7).
- o Rock/soil-quality analytical results (Figure 4.8).
- o Slug test data (Figure 4.9).

The completed forms will be submitted as part of the ground-water report. This report will be included in the site file.

7.[5].2 Reports

Three ground-water reports will be prepared as needed: a background and baseline report; a detection monitoring report; and a compliance monitoring and action report.

The background and baseline reports will include:

- o A narrative comparing pre-closure and post-closure water quality and ground-water hydraulics.
- o A map showing the surveyed locations of the stabilized pile, all monitoring wells and the site boundary, and an indication of the direction of ground-water flow in all monitored hydrogeologic units.

- o A table summarizing well installation and completion data.
- o A table summarizing water-quality data for the detection monitoring parameters. This table will include the results of chemical analysis, means, standard deviations, and detection monitoring limits for all parameters at each well.
- o A table summarizing water-quality data for the compliance parameters that are not detection parameters. This table will include all the information that is included on the previous table except excursion detection limits.
- o A table summarizing the results of the slug test analyses, including each calculated value of hydraulic conductivity at each well and the mean and standard deviation of these values at each well.
- o A table summarizing the results of the chemical analysis of soil and rock samples.
- o All completed field and laboratory forms.

The detection monitoring report will include:

- o A table comparing water-quality analytical results against the appropriate excursion detection limits.
- o A narrative describing any significant trends or anomalies in the water quality or water-level data. The narrative also may include a comparison of collected data to values predicted in the site-specific environmental document.
- o A narrative describing any significant changes in the local hydrologic setting.

[The compliance monitoring and action report will be needed only following an excursion.] The compliance monitoring and action report will include:

- o A log of all verbal and written communications between the responsible agency and the NRC following the detection of a possible excursion.
- o Completed field and laboratory forms compiled in chronological order.
- o Tables summarizing the data.
- o If additional fieldwork was required, a description of the fieldwork with all appropriate documentation, including maps, logs, soil samples and/or cores, surveys, and the like.
- o A narrative describing the procedures required to identify the nature and extent of the excursion[, a hydrogeolo-]

[gic analysis,] and the actions required to mitigate it or a narrative describing the procedures required for a negative determination (no excursion).

These reports will also be maintained in the site file for the duration specified in Section 7.[4].

7.[6] AERIAL PHOTOGRAPHY

7.[6].1 Records

Aerial photographic records will consist of the items listed in Table 7.1. An aerial photographic record will be assembled in the site file. Photographs will be stored in archival-quality storage containers.

7.[6].2 Reports

Reports of photo interpretation studies will be included in the site file along with other reports for each site. Evaluations of performance on photo interpretation studies will be documented.

7.[7] MAINTENANCE AND CONTINGENCY REPAIR

7.[7].1 Records

Maintenance and contingency repair records will consist of:

- o Reports from the maintenance contractor(s).
- o Reports from the contingency repair contractor(s).
- o Communications from agencies or others reporting a need for contingency repair.

These records will be maintained in the site file for the duration specified in Section 7.[4].

7.[7].2 Reports

Summary reports will be prepared whenever maintenance or contingency repairs are affected. Reports will be prepared by the contractor for review and approval by the responsible agency. The reports will:

- o Describe existing conditions at the site prior to action.
- o Describe actions undertaken to affect maintenance or repair.
- o Provide photographic documentation of maintenance or repair.

Table 7.1 Aerial photographic records

1. Aerial photograph print sets.
 - a. Vertical stereo aerial photograph contact prints.
 - b. Oblique aerial photographs - contact prints or enlargements.
 2. Flight path index maps for each aerial photography flight.
 3. Letters of acceptance or rejection for each set of aerial photographs.
 4. Aerial photo interpretation keys with accompanying descriptive reports.
 5. List of names and addresses of contractors possessing film negatives for specific UMTRA Project sites.
-

REFERENCES

- ASP (American Society of Photogrammetry), 1980. Manual of Photogrammetry, 4th Edition.
- ASP (American Society of Photogrammetry), 1968. Manual of Remote Sensing.
- ASP (American Society of Photogrammetry), 1960. Manual of Photographic Interpretation.
- ASTM (American Society for Testing and Materials), 1984. Annual Book of ASTM Standards - 1984.
- Carneggie, D. M., and J. J. Reppert, 1969. "Large-Scale 70mm Aerial Color Photography," in Photogrammetric Engineering, Vol. 35, pp. 249-257.
- DOE (U.S. Department of Energy), 1984a. Project Licensing Plan, UMTRA-DOE/AL-150524, prepared by the U.S. Department of Energy, UMTRA Project Office, Albuquerque Operations Office, Albuquerque, New Mexico.
- DOE (U.S. Department of Energy), 1984b. Plan for Implementing EPA Standards for UMTRA Sites, UMTRA-DOE/AL-163, prepared by the U.S. Department of Energy, UMTRA Project Office, Albuquerque Operations Office, Albuquerque, New Mexico.
- Driscoll, R.S. and M.D. Coleman, 1974. "Color for Shrubs," in Photogrammetric Engineering, Vol. 40, p. 451.
- Eav et al. (B.B. Eav, C.A. Clark, R.E. Hinkle, and J.C. Prill), 1981. "Photo Interpretation Key for Pine Regeneration Analysis Using High Altitude Color Infrared Panoramic Photography", Final Report. Report No. LEMSCO-16379, U.S. Department of Agriculture, Nationwide Forestry Applications Program, Houston, Texas.
- Tueller, P.T., 1979. "Some Aspects of the Use of Dichotomous Keys to Aid in the Interpretation of Color Aerial Photographs for Vegetation Mapping," in Proceedings of the Seventh Biennial Workshop on Color Aerial Photography in the Plant Sciences, American Society of Photogrammetry, pp. 189-200.
- Tueller, P.T., and D.T. Booth, 1974. Photographic Remote Sensing Techniques for Erosion Evaluation on Wildlands, a Final Report to the U.S. Department of the Interior, Bureau of Land Management, Contract 08550-CTS-2.

GLOSSARY

adjacent area	The area surrounding a site. The distance from a site included in the term adjacent area is not fixed, but is determined on a site-by-site basis taking into consideration how off-site geology, topography, drainage, land use, and man-made features could affect site integrity.
alluvium	A general term for clay, silt, sand, gravel, or similar unconsolidated material deposited by a stream as sediment in the bed of the stream, its floodplain, or its delta.
anisotropy	Condition of having physical properties that vary in different directions.
arid	Environment characterized by discontinuous (usually sparse) vegetation.
arroyo	A term applied in the southwest United States to the deep, flat-floored channel of an ephemeral stream, usually with vertical or steeply cut banks of unconsolidated material at least 60 cm high.
as-built	Engineering drawings that detail actual constructed conditions.
background water quality	The representative water quality after completion of remedial action from a given hydrogeologic unit that has not been impacted by past or present activities or, if impacted by past activities, no longer exhibits the impacts.
basalt	A general term for dark-colored, fine-grained, igneous rocks, commonly extrusive but locally intrusive (e.g., as dikes), composed chiefly of calcic plagioclase and pyroxene.
base level (local)	A local limit on downward fluvial erosion established by resistant rock, deposition datum, or similar feature.
base map	A topographic map of the disposal site. The scale will not be less than 1:24000 or at a contour interval of not more than two feet.
baseline data	Documents that describe the as-built site. These include as-built drawings, ground and aerial photographs, site vicinity map, base map, and site atlas.

baseline photographs Photographs taken of the site upon completion of remedial action work to provide a baseline set of photographs for comparison with photos taken during subsequent inspections.

baseline water quality The representative water quality from a given hydrogeologic unit that has been impacted by past or present activities at the mill site, but should not be affected in the future.

blowout A general term for a saucer- or trough-shaped depression formed by wind erosion in an area of loose soil or where protective vegetation has been destroyed.

boundary monument A durable marker installed on a property boundary with its location accurately known in relation to established survey monuments.

braided stream Runoff flowing on alluvium and depositing alluvium as obstructions to produce an interwoven flow pattern within a channel or valley.

coefficient of variation The ratio of the standard deviation of a distribution to its arithmetic mean.

colluvium Loose, heterogeneous soil material and/or rock fragments deposited by rainwash or creep and usually found on hillsides or the base of slopes.

construction photographs Photographs taken during the remedial action to document the work and conditions encountered.

contingency repair A repair action taken to correct a situation affecting site integrity.

crab In aerial photography, the condition caused by failure to orient the camera with respect to the track of the airplane, indicated in vertical photography by the sides of the photographs not being parallel to the principal-point baseline.

creep The slow, more or less continuous, downslope movement of mineral, rock, and soil particles under gravitational stresses.

data back A replacement camera back that automatically records the date of each photograph and photograph number on the film negative as the photograph is exposed.

dendritic A drainage pattern in which the streams branch randomly in a pattern resembling the branching habit of many deciduous trees.

disposal	The planned safe permanent placement of radioactive waste.
elutriation	The process of extracting one material from another. Also known as elution; levigation.
ephemeral	Runoff limited to times of rainfall (or snowmelt) and shortly thereafter.
erosion control markers	Stakes or other markers established as reference points from which to measure the progress of erosion.
escarpment	A steep face terminating high lands abruptly; a cliff.
excursion	A rise in downgradient contaminant level so far removed from baseline or background values that its presence cannot be attributed to the random combination of chance causes.
fan (alluvial)	A broad, flattened connate alluvial deposit, usually situated at the base of a steep slope or cliff.
final site conditions	Equipment and procedures necessary for post-remedial action surveillance.
floodplain	The flattened area along a river subject to periodic overflow.
ground water	Water below the land surface, generally in a zone of saturation.
gully	(a) A small valley worn in unconsolidated material by running water and through which water runs only after a rain or the melting of snow or ice; (b) any erosion channel so deep that it cannot be crossed by a wheeled vehicle or eliminated by plowing.
heterogeneity	A characteristic of a medium which signifies that the medium has properties which vary with position within it.
hydraulic conductivity	Ratio of flow velocity to driving force (for viscous flow under saturated conditions of a specified liquid in a porous medium).
hydraulic gradient	[The] change of static head per unit distance [along a streamline.]
landslide	Downslope movement of a comparatively large mass of rock debris, usually rather suddenly.

licensing In this report, the process by which the NRC will, after the remedial actions are completed, approve the final disposition and controls over a disposal site.

mass movement All processes by which soil and rock material are transported downslope predominantly enmasse by the direct application of gravitational body stresses.

monitor To observe and make measurements to provide data to evaluate the performance and characteristics of the disposal site.

NQ The wireline designation for NX.

NX A core produced with an N drill rod with an outside casing diameter of 3.5 inches, outside casing bit diameter of 3.5625 inches, outside core barrel bit diameter of 2.9375 inches, outside drill rod diameter of 2.375 inches, approximate corehole diameter of 3 inches and an approximate core diameter of 2.125 inches.

outlier (statistical) In a set of data, a value so far removed from other values in a distribution, that its presence cannot be attributed to the random combination of chance causes.

overlay Transparent, sepia, or blue line prints overlying a site base map and depicting locational data of significant features such as photo locations, erosional patterns, vegetation, and the like. To be used by the site inspectors to record site features.

passive controls Those controls which inhibit human contact with the waste and depend on a continuing social order. Examples include Federal ownership of a disposal site, monuments on the site, records with agencies, and physical barriers (e.g., riprap covers, vegetation, waste burial).

pedestal rock A tall, slender erosion remnant of any size.

permeable zone A porous layer, bed, or formation through which water can flow.

pipng Erosion by percolating water in a layer of subsoil, resulting in the formation of narrow conduits, tunnels, or "pipes" through which soluble or granular soil material is removed.

rain splash erosion Erosion by raindrops falling on bare ground.

responsible agency The government agency responsible for maintaining site integrity and ensuring compliance with the site license.

rill A very small stream or the small channel eroded by water; one of the first and smallest channels formed by runoff.

rivulet A small stream; a streamlet developed by rills running down a steep slope.

rock Rock materials (sometimes with rock diameter specifications) that are not screened for size segregation prior to use in the construction industry.

scarp A steep slope separating surfaces at two different levels.

sheet erosion The removal of surface material more or less evenly rather than by streams flowing in well defined channels.

Shelby tubes A thin-walled tube sampler conforming to ASTM D1587 standards and used to obtain relatively undisturbed soil samples.

shrinkage crack A crack produced in fine-grained sediment or rock by the loss of contained water during drying or dehydration.

signatures Distinctive features or characteristics of modifying processes.

site atlas A set of plans reflecting the as-built condition of the site used by site inspectors to help locate specific features and to record inspection conditions.

site file A compilation of site data assembled for the purpose of indoctrinating inspectors on the site characteristics before they enter the field. The site file will include narrative, photos, maps, plans, sketches, and previous reports.

site map See base map.

site marker Durable monuments bearing information regarding the site.

split spoon A split barrel sampler commonly used to perform penetration tests on soil and rock according to ASTM D1586 standards and to obtain disturbed soil samples.

stabilization The reduction of radioactive contamination in an area to a predetermined level [set] by a standards-setting board such as the EPA, by encapsulating or covering the contaminated material.

State plane coordinate system Grid systems particular to states used to determine locations on the land surface.

stereo coverage The use of aerial photograph pairs taken from sequential photographs along a flight line which, when viewed through a stereoscope, produce a three-dimensional image.

surveillance In this plan the observation or monitoring of the disposal site for purposes of visual detection of need for custodial care, evidence of intrusion, and compliance with other license and regulatory requirements.

survey monument A durable marker of known elevation and horizontal location set firmly in the ground, and established for the express purpose of being a reference point for future surveys.

tailings, uranium mill The wastes remaining after most of the uranium has been extracted from uranium ore.

toe slope The lower segment of a hillslope.

transect In ecology, a sample area (usually elongate or linear) chosen as the basis for studying a particular assemblage of organisms.

transmissivity, hydraulic A measure of the ability of an aquifer to transmit water equal to the product of the hydraulic conductivity and the thickness of the aquifer, expressed in length²/time.

unconfined aquifer An aquifer that is not confined by impermeable beds. The upper surface is called the water table.

UMTRA Project Uranium Mill Tailings Remedial Action Project of the U.S. Department of Energy.

vicinity map A map that depicts the disposal site and surrounding environs (minimum of 0.25 mile).

ACRONYMS

ASTM	- American Society for Testing and Materials
CFR	- Code of Federal Regulations
DOE	- U.S. Department of Energy
EPA	- U.S. Environmental Protection Agency
NGS	- National Geodetic Survey
NOAA	- National Oceanic and Atmospheric Administration
NRC	- U.S. Nuclear Regulatory Commission
PSMP	- Project Surveillance and Maintenance Plan
PVC	- Polyvinyl Chloride
RAC	- Remedial Action Contractor
RF	- Representative Fraction
SSMP	- Site Surveillance and Maintenance Plan
TAC	- Technical Assistance Contractor
UMTRA	- Uranium Mill Tailings Remedial Action
USGS	- U.S. Geological Survey

APPENDIX A
INSPECTION PHOTO LOG

INSPECTION PHOTO LOG

Information required

Instructions

Time of day

Log inclusive times for roll of film being exposed.

Weather conditions

Describe weather/lighting conditions for period that roll is being exposed.

Type of film

Give manufacturer's name, film name, and film speed.

Roll number

Number each roll exposed.

Photographer's location

Certain locations will be specified in the Site Surveillance and Maintenance Plan and on the site's photo maps. Use these location symbols. If photographing an anomalous or new feature, and a photo location site does not apply, describe the location by azimuth/distance from a known location (e.g., monument, boundary, or site marker).

Photo description

A brief description of what is being photographed.

Remarks

As necessary to document photo, conditions, or why a photo was taken (if not a standard photo).

INSPECTION PHOTO LOG

Site: _____ Date: _____

Time of Day: From _____ To _____

Weather Conditions: _____

Type of Film: _____

Roll Number: _____

Frame #	Photographer's Location ^a	Photo Description	Remarks
1	_____	_____	_____
2	_____	_____	_____
3	_____	_____	_____
4	_____	_____	_____
5	_____	_____	_____
6	_____	_____	_____
7	_____	_____	_____
8	_____	_____	_____
9	_____	_____	_____
10	_____	_____	_____
11	_____	_____	_____
12	_____	_____	_____
13	_____	_____	_____
14	_____	_____	_____
15	_____	_____	_____
16	_____	_____	_____
17	_____	_____	_____
18	_____	_____	_____
19	_____	_____	_____
20	_____	_____	_____
21	_____	_____	_____
22	_____	_____	_____
23	_____	_____	_____
24	_____	_____	_____
25	_____	_____	_____
26	_____	_____	_____
27	_____	_____	_____
28	_____	_____	_____
29	_____	_____	_____
30	_____	_____	_____
31	_____	_____	_____
32	_____	_____	_____
33	_____	_____	_____
34	_____	_____	_____
35	_____	_____	_____
36	_____	_____	_____

Inspector: _____
Signature

Printed Name

^aReference to photo overlay, if possible.

APPENDIX B
MODIFYING PROCESSES

TABLE OF CONTENTS

<u>Section</u>	<u>Page</u>
B.1 GENERAL	B-1
B.2 GULLYING ON THE SITE	B-3
B.2.1 Description	B-3
B.2.2 Factors influencing development	B-3
B.2.3 Criteria for early detection.	B-3
B.3 HEADWARD GULLY (ARROYO) CUTTING.	B-7
B.3.1 Description	B-7
B.3.2 Potential for gully development	B-7
B.3.3 Criteria for detection.	B-7
B.4 MASS MOVEMENTS	B-9
B.4.1 Landslides.	B-9
B.4.2 Creep	B-9
B.4.3 Piping.	B-11
B.5 SHEET EROSION.	B-13
B.6 CRACKING	B-15
B.7 LATERAL STREAM CUTTING	B-17
B.8 INTRUSION BY ANIMALS	B-19
B.9 INTRUSION BY PLANTS.	B-21
B.10 EXTREME NATURAL EVENTS	B-23
BIBLIOGRAPHY FOR APPENDIX B.	B-25

LIST OF FIGURES

<u>Figure</u>	<u>Page</u>
B.1.1 Typical above grade UMTRA Project site.	B-2
B.2.1 Relationship between desiccation cracks and rills	B-4
B.4.1 Examples of cracks, bulges, scarps, and springs	B-10
B.7.1 Channel classification showing relative stability and types of hazards encountered with each pattern.	B-18

LIST OF TABLES

<u>Table</u>	<u>Page</u>
B.8.1 Burrowing rodents that may occur at the disposal site	B-20
B.9.1 Plant species with deep root systems that have the potential for colonizing sites	B-22

B.1 GENERAL

For purposes of inspection, the disposal sites, particularly those above grade, may be viewed as artificial landscape features subject to the same modifying processes as is the natural landscape. The more significant of these processes are briefly described in this section. Additional reference materials are listed at the conclusion of this appendix.

The action of most of these processes is slow, but significant modification of landscapes can and does occur over periods of several hundred years. Detection of change will require an understanding of the processes and the observation and recording of subtle changes.

It should be kept in mind that under natural conditions, these processes do not operate in isolation from one another. Rather, they interact in complex fashion, with local topography, with land use, and with climate. They may operate in succession or simultaneously, and they may intensify or inhibit one another. Which one will predominate may depend upon minor and random factors.

Above grade, or partially below grade, stabilization is expected to be the preferred remedial action for most UMTRA Project disposal sites. Figure B.1.1 depicts an idealized but representative site. The uranium tailings are covered by an inner cover of several feet of soils suitable as a radon barrier, and another layer of rock for erosion protection. The shape of the pile will be modified to approximately that of a truncated pyramid with crown slopes of five percent or less, and sideslopes of about 20 percent or less. A system of drainage ditches and diversion channels is shown at the toe of the slope. Also shown in Figure B.1.1 are a nearby perennial river, an arroyo, roads, and various survey monuments, erosion control markers, and boundary monuments.

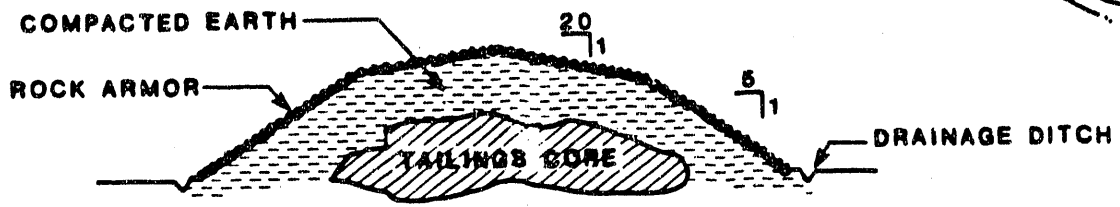
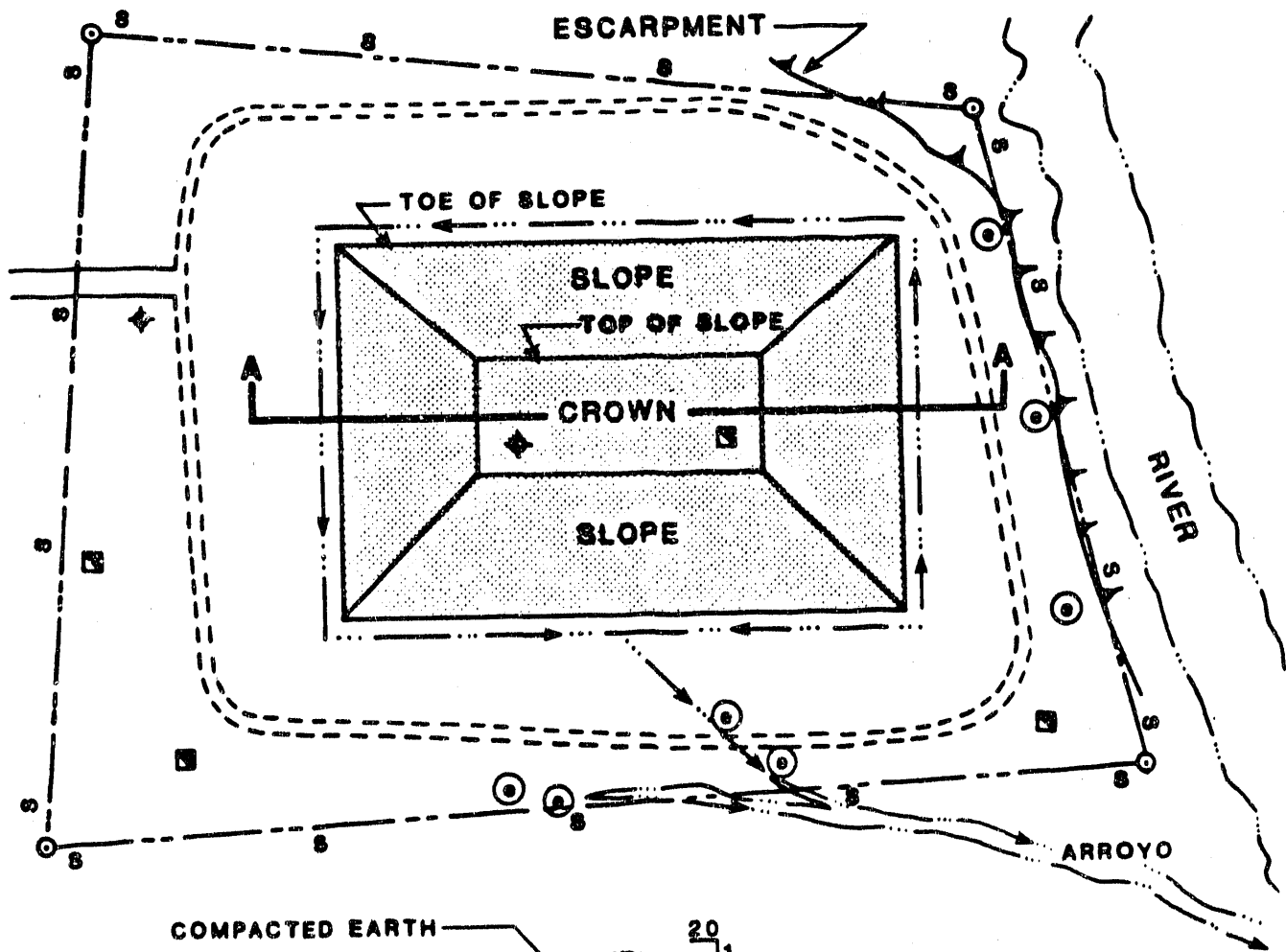

SECTION A-A

LEGEND

- SURVEY MONUMENT
- ◆ SITE MARKER
- ⊙ EROSION CONTROL MARKER
- BOUNDARY MONUMENT
- PROPERTY BOUNDARY
- - - ACCESS ROAD
- DIRECTION OF FLOW
- S SIGNS

**FIGURE B.1.1
TYPICAL ABOVE GRADE UMTRA PROJECT SITE**

B.2 GULLYING ON THE SITE

B.2.1 DESCRIPTION

Gullies are incised channels that carry runoff only during periods of rainfall and snowmelt or shortly thereafter (Figure B.2.1). In size, they vary over a considerable range. Although no sharp distinctions are recognized, smaller channels are usually called rills or rivulets. At the other extreme, large gullies may be several tens of feet deep and several miles long. Gullies are characteristically steep-walled and have V-shaped cross-sections in their active reaches. In the southwestern United States, the terms "gully" and "arroyo" are commonly used interchangeably.

Above-grade tailings sites can be affected by the development of gullies on the slopes as a result of concentrated runoff of precipitation; both above-grade and below-grade sites can be affected by off-site gullies which enlarge by headward erosion into the site. In this section, on-site gully development is considered. Section B.3 considers the development of gullies off the site and their migration into the site.

B.2.2 FACTORS INFLUENCING DEVELOPMENT

Gully development is a consequence of the expansion of a drainage network and is a normal feature in the erosional modification of landscapes. Gullies develop when runoff is concentrated and has the erosive capability of dislodging and transporting soil particles.

High intensity rainfall episodes, concentration of runoff, steep slopes, long slopes, silty soil, and sparse vegetation are the principal factors which favor gully development. Gully erosion may develop as an advanced stage of rill or rivulet erosion, but it also may be initiated by the concentration of runoff due to such processes as landsliding, cracking, or the burrowing of animals.

High intensity summer thunderstorms typical of the arid and semi-arid west combined with the lack of vegetation makes gullying a major process of landscape modification. The most important means of limiting gully development will be by armoring the piles with erosion-resistant material and by shaping the piles to prevent concentration of runoff.

B.2.3 CRITERIA FOR EARLY DETECTION

Although stabilization of the piles will be designed to prevent concentration of runoff, minor irregularities will, in time, cause runoff to become organized into a typical dendritic pattern of rivulets and rills. As the runoff will have little sediment load, erosion may be concentrated on the lower slopes. These rills may be ephemeral, appearing and disappearing with different intensities of rainfall, or they may be distributed so uniformly over the slopes that localized intensive erosion is not initiated. If either of these conditions occur, the design

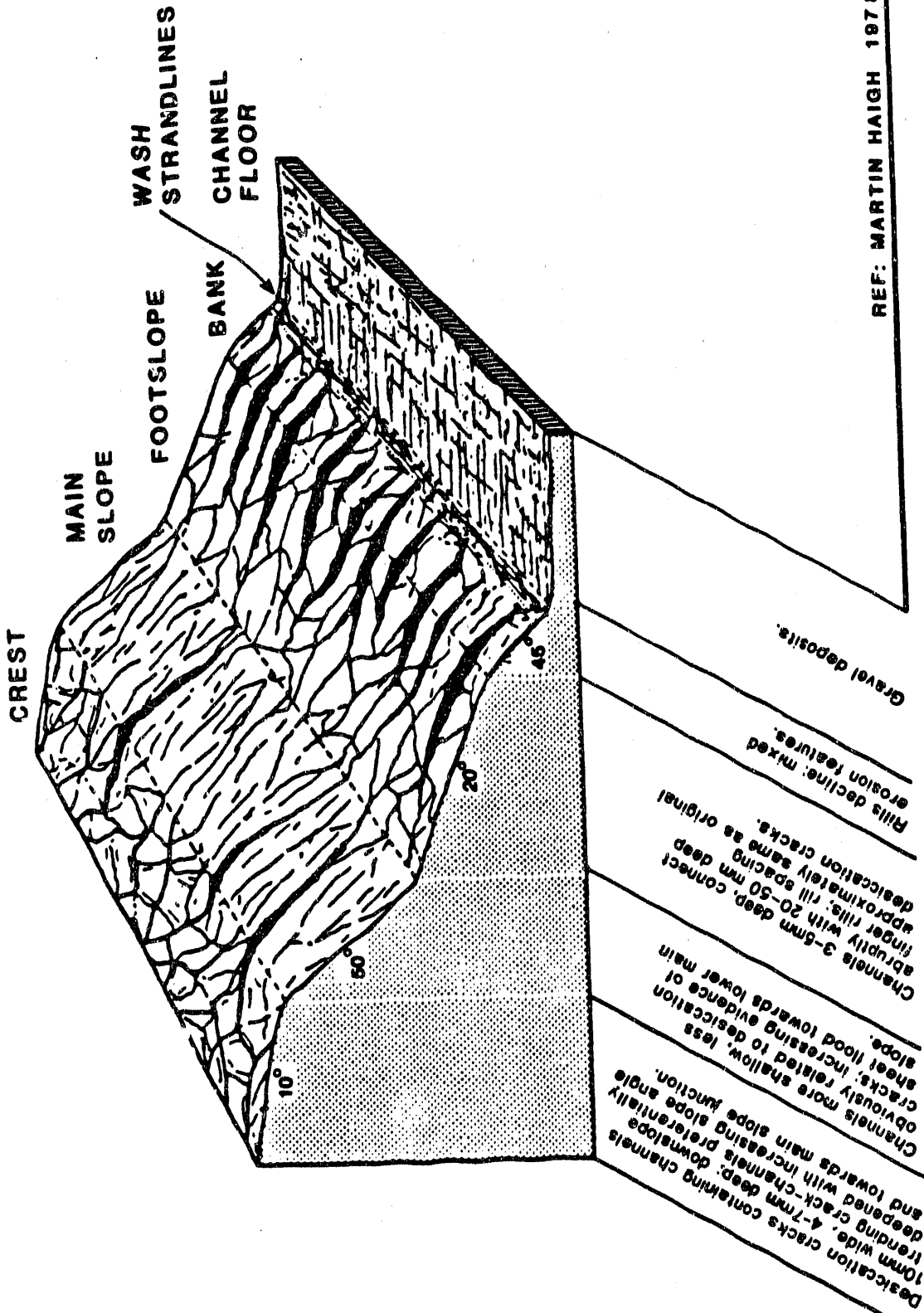

REF: MARTIN HAIGH 1978.

FIGURE B.2.1 RELATIONSHIP BETWEEN DESICCATION CRACKS AND RILLS

is effective and no remedial action will be indicated. If, however, one or more master channels with tributaries have developed, maintenance probably will be required.

Gully initiation may also arise from the interaction of water erosion with some other disturbance of the pile slopes such as cracking, animal burrowing, or a landslide. These mechanisms are described individually in Sections B.6, B.9, and B.4, respectively. Although such disturbances may directly affect the integrity of the tailings pile, their greater threat is that they may be initiating gully development.

If direct development of gullies does occur, they will in all likelihood become noticeable within a few years (depending upon occurrence of intense rainstorms); the indirect development is less predictable and remains a long-term threat because it can result from such slow processes as deterioration of the protective rock material, gradual localized differential settlement, or the downhill creep of the pile surface material.

B.3 HEADWARD GULLY (ARROYO) CUTTING

B.3.1 DESCRIPTION

As pointed out in Section B.2, gullies are a normal consequence of the expansion of a drainage system, and therefore, wherever tailings are located on an immaturely dissected natural surface, potential exists for downstream drainage channels to expand by headward erosion and dissect the tailings pile.

B.3.2 POTENTIAL FOR GULLY DEVELOPMENT

The factors which encourage development of gullies off the site are the same as those on the site. Thus, gully growth is more of a problem:

- o On alluvium or other easily eroded soil or rock rather than on consolidated bedrock.
- o Where runoff is concentrated.
- o Where revegetation is sparse.
- o Where steep slope segments provide a point for initiation of a gully.
- o Where drainage areas are relatively large.
- o Where and when rainfall intensity is greatest.

Gullies are least likely on vegetated surfaces of low slope and low relief isolated from easily eroded material by a local base level of highly resistant rock.

B.3.3 CRITERIA FOR DETECTION

Determining whether downstream gully development and headcutting will occur may be obvious from observations of the existing landscape or may require sophisticated geomorphic analysis.

Actively eroding gullies can ordinarily be identified by a V-shaped cross-section and the absence of debris and vegetation at the bottom of the channel. However, it cannot be assumed that if these features are not present, the gully is or will remain stable. Active erosion has a minimum runoff intensity that will initiate headcutting and this threshold may be associated with low frequency precipitation events. Thus, it is not uncommon for a gully to have no headward growth for a number of years, but to have headward cutting of several hundred feet during a single storm.

Furthermore, development of gullies may depend upon conditions that arise outside the immediate drainage area. These conditions may include a decrease in vegetative cover due to overgrazing or changes in land use, concentration of flows due to roads or trails, lowering of base level as a result of breaching of a resistant rock layer, a change of course or regime of a main stream, or a change in climate which results in greater peak runoffs.

B.4 MASS MOVEMENTS

B.4.1 LANDSLIDES

The term "landslide" describes a wide variety of mass movements of soil and rock material downslope under gravitational influence. Landslides include falls, avalanches, slumps, and earth and debris flows that are characterized by a surface of shear failure at the base of the moving mass. Landslides occur when the cohesion or frictional resistance of the material is exceeded by the weight of the material. Water in the pores of the material reduces frictional resistance and also increases the weight of the sliding mass. Hence, most landslides occur during or shortly after periods of heavy rainfall.

Landslides can be classified according to the type of movement involved. Falls and topples denote a rapid movement from a steep slope or cliff. Slides, whether rotational or translational involve shear strain and displacement along one or several surfaces. Rotational slides are slumps which are slides along a surface of rupture that is curved concavely upward. Translational slides progress out and down and out along a more or less planar or gently undulatory surface. Earth flows and debris flows are almost always translational and characteristically are tongue-shaped with a lobate frontal edge and a tendency to form a fan-shaped deposit where slope decreases.

Vulnerable locations are steeper slopes, areas having bedrock with steeply dipping bedding planes, areas being undercut, and any area showing evidence of past landslides. Criteria for recognizing old landslides include "hummocky" topography, bulges on the ground surface, scarps, slickensides, cracks, and disturbed vegetation (Figure B.4.1). Flows can be recognized from their channel-like and fan shape.

Design and construction of the sites will be such as to minimize the likelihood of sliding of the site material. The possibility of its occurrence cannot be totally excluded; however unlikely, sliding could conceivably be initiated by differential settling within the pile or by water lubricated movement along the plane which separates a highly permeable outer layer from a relatively impermeable inner material. In the former situation, the slide is likely to be rotational. Scarps at the top of the slide and depressions and bulges will be observable. In the latter situation, the slide is more likely to be planar and the observable phenomena are likely to be undulatory or "wrinkled" slopes and bulges at the lower parts of the slopes.

B.4.2 CREEP

Creep is the surface and near surface slow downslope movement of soil or rock (Figure B.4.1). It is the sum of a very large number of minute displacements of individual grains or particles not all moving at the same rate. The basic agent is gravity and the movement is aided by

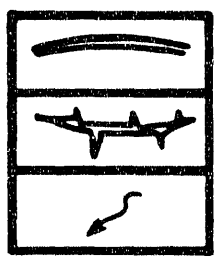
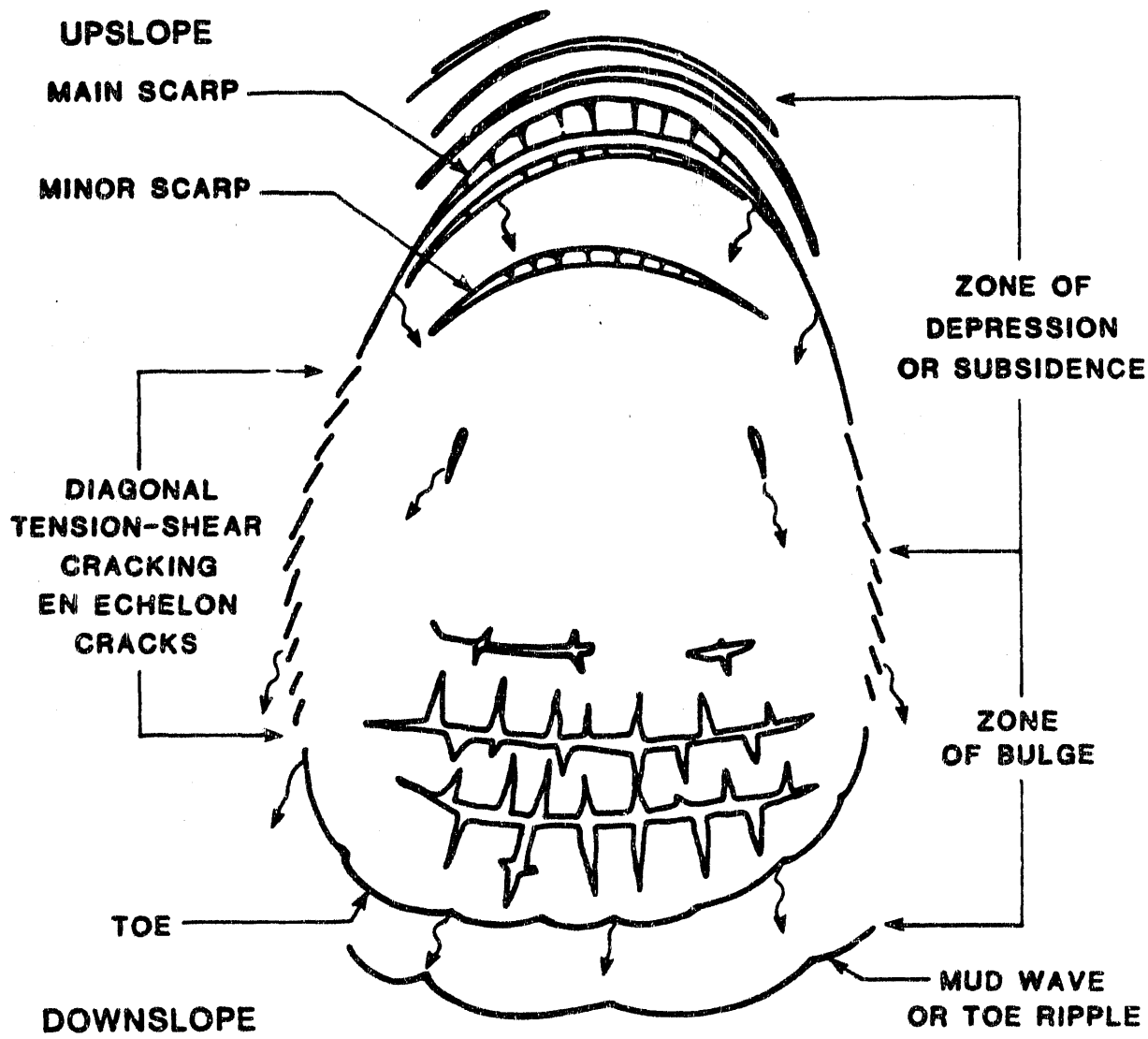

TENSION CRACK: POSSIBLY
SHEAR DISPLACEMENT DOWNHILL

TENSION CRACK ON TOE BULGE

SPRINGS, SEEPS

FIGURE B.4.1
EXAMPLES OF CRACKS, BULGES, SCARPS, AND SPRINGS

wetting and drying, freezing and thawing, rainwash, and the action of animals and plants. The movement is commonly imperceptible over short periods of observation, but field studies in Colorado (Schumm, 1967) have shown that for 20 percent slopes, movement of about 30mm per year can be expected. Thus, it is important to note the subtle indications of creep, such as deflection of plants, evidence of "stretching" of the ground surface, and development of small-scale terraces more or less parallel to contours.

B.4.3 PIPING

Piping involves the formation of tunnels in dispersive clay or silty soils. Failure related to piping can occur in the tailings materials or in the natural foundation soils under the pile. Piping and failure can also occur due to the removal of water soluble minerals (gypsum) contained in the tailings materials or natural foundation soils.

Field inspection observations will note any evidence of a desiccated and cracked ground surface, steep-sided channels and tunnels, and visible mineral deposits (gypsum), or efflorescence in the soils.

B.5 SHEET EROSION

Sheet erosion results from the impact of raindrops loosening and detaching soil particles, and transporting sediment in small ephemeral rills. The rills form almost simultaneously with the first detachment of particles. These rills meander and migrate constantly with the result that erosion is more or less uniform over a slope. However, variations in slopes, soil characteristics, or vegetation may concentrate rilling and lead to the initiation of larger and more permanent drainage channels.

Nature of the soil material, length and degree of slope of the land, vegetative cover, and rainfall intensity are the principal factors that control sheet erosion at a site. Other than rainfall intensity, these factors are subject to modification, and all remedial work will involve some combination of modifying the surface material, decreasing slopes, and/or increasing the vegetative cover.

Mitigating the potential for sheet erosion will be a primary concern in the design of each site. If sheet erosion is prevented, the more destructive channeled erosion is unlikely to be initiated, and thus, detection of any departure from expected performance may be significant. Because the amount of sheet erosion is relatively uniform over large areas, evidence that it is occurring is likely to be subtle. Accumulation of sediment at the base of slopes, the presence of pedestal rocks, or partially exhumed vegetation will be suggestive of active sheet erosion.

Mitigative measures for sheet erosion by water will normally also protect against wind erosion. It is conceivable, however, that turbulence near the crest of the site may result in "blowouts." Such blowouts can lead to rilling or gullyng.

B.6 CRACKING

Cracks may develop on a disposal site as a result of [five] processes: 1) settlement of the foundation or compressible material in the tailings, (2) sliding or flowing of the soil and rock within the site slopes, 3) shrinkage of highly plastic clays in the tailings or in the site cover[, 4) vibratory ground motion, and 5) fault displacement.]

Settlement cracks tend to be oriented more or less parallel to the circumference of a settled area, and more than one ring of cracks may be present. The cracks are likely to be inclined toward the center of the disturbed area. Scarps may or may not be present, depending upon the amount of displacement. Settlement cracks may extend deep into the embankment and thus offer pathways for entry of water and initiation of erosion.

Cracks caused by landslides can be expected to have the typical pattern shown in Figure B.4.1. At the upslope end of the disturbed mass, one or more scarps facing downslope will be present. Cracks associated with these scarps will be curvilinear, concave downslope, and inclined toward the slide. En echelon shear cracks can be expected along the flanks of the disturbed area, and tension cracks on the bulge at the lower part of the slide. Some of the cracks at the upper part of the slide will extend to the surface on which sliding is taking place. Depending upon the size of the slide, amount of movement, and the character of the material, the flank cracks may be deep or shallow. Cracks on the bulge or lower part of the slide tend to be superficial.

Shrinkage cracks develop as clays with expandable lattices (plastic clays) lose their water, and are common phenomena seen at the surface as swelling clays dry. Such cracking typically develops in a roughly hexagonal pattern, although cracks rarely penetrate more than a few inches below the surface.

Shrinkage cracks are important in that they contribute to the integration of drainage patterns in the early stages of slope modification. Because of shrinkage cracks, sheet erosion becomes channelized, and the likelihood of gullies is increased.

B.7 LATERAL STREAM CUTTING

Lateral stream cutting is a process whereby a flowing stream changes course or expands its channel and cuts into an adjacent streambank, terrace, or slope. Lateral cutting can be slow (years) or rapid (hours or days), depending upon the shape of the channel, amount of water discharge, and the type and quantity of sediment carried by the stream.

The extent and rate of stream cutting at a particular site is difficult to predict because they can be changed drastically by natural or human activities remote from the site. Examples include floods, forest fires, landslides, channelization, and construction of dams, bridges, or dikes. Examination of historical sequences of aerial photos can be used for recognizing past and possible future changes in lateral cutting patterns.

The degree to which lateral cutting poses a potential hazard will depend upon the site characteristics and the nature of the stream. Tailings sites which are on floodplains and which are near the stream are obviously of greatest concern. However, landslides induced by lateral cutting or major channel shifts can affect sites that are above maximum flood levels and apparently otherwise safe.

A simplified channel classification scheme for estimating the potential for lateral stream cutting has been developed by Schumm and Chorley (1983). As shown in Figure B.7.1, the scheme includes three channel types: 1) straight (two sub-types), 2) meandering (three sub-types), and 3) braided. Generally, resistance to lateral cutting is greatest for straight channels which carry fine sediments and least for braided channels which carry coarse sediments. These channel types, including the secondary features of bars and sediment load, are relatively easy to recognize from field observations and aerial photographs.

Many streams have been modified by dikes, levees, channel linings, or other construction which have, at least in part, the objective of limiting lateral stream erosion. The effectiveness of these at any particular site cannot be safely assumed over long periods of time, and periodic checks are necessary. Normally, major channel changes are most recognizable after high flow events.

CHANNEL TYPE

Suspended Load

Mixed Load

Bed Load

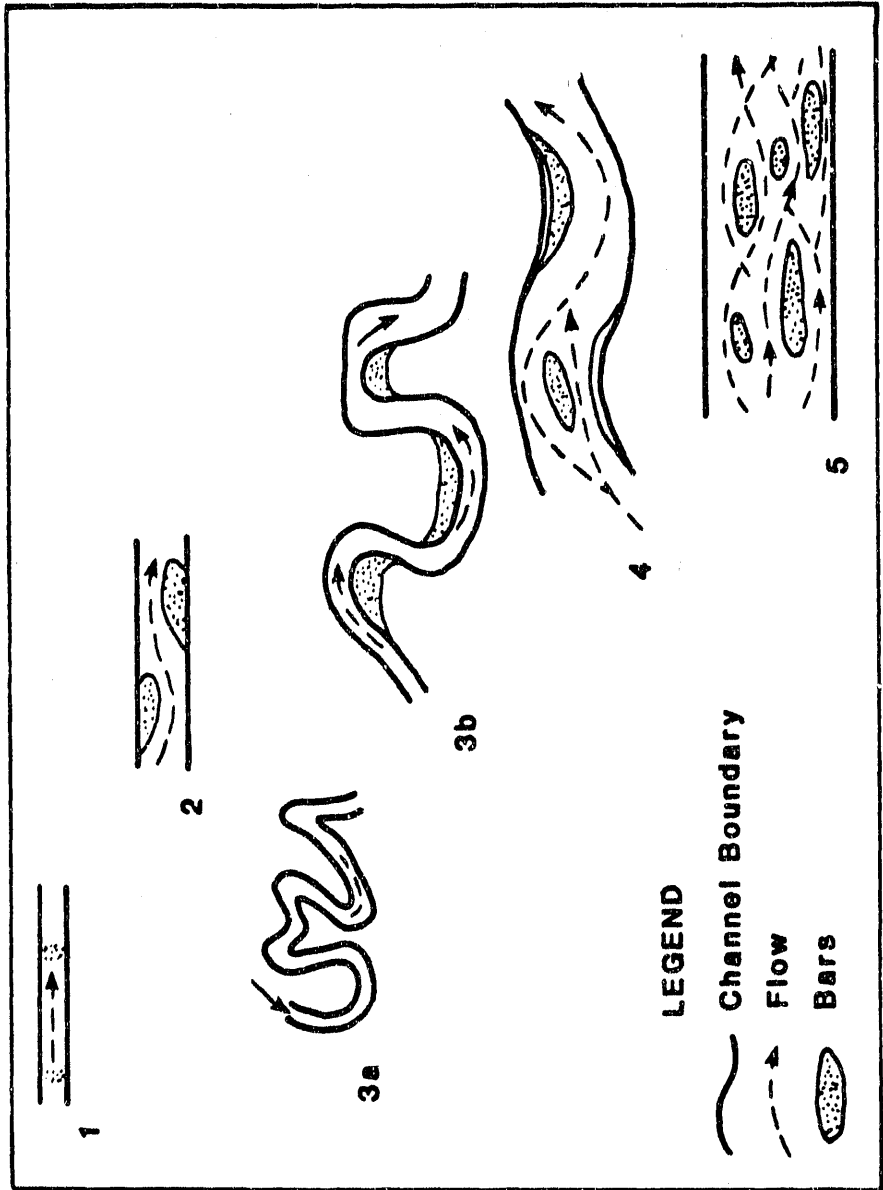

CHANNEL PATTERN

STRAIGHT MEANDERING BRAIDED

High Gradient → Low Gradient

High Width-Depth Ratio → Low Width-Depth Ratio

High → Low

RELATIVE STABILITY

LOW → HIGH

Channel Shift Meander Shift Neck Cutoff Avulsion

Channel Shift Meander Shift Alternate Bar Chute Cutoff Shift

LEGEND

- Channel Boundary
- Flow
- Bars

HIGH → RELATIVE STABILITY → LOW

(3% >) Low → Bed Load/Total Load Ratio → High (> 11%)

Small → Sediment Size → Large

Small → Sediment Load → Large

Low → Flow Velocity → High

Low → Stream Power → High

FIGURE B.7.1

CHANNEL CLASSIFICATION SHOWING RELATIVE STABILITY AND TYPES OF HAZARDS ENCOUNTERED WITH EACH PATTERN

B.8 INTRUSION BY ANIMALS

Intrusion by animals into a site can produce four types of problems: 1) mammals burrowing into the cover of the tailings can weaken the cover and enhance erosion and slumping, particularly on the steeper sideslopes; 2) grazing animals may develop trails that concentrate erosion; 3) burrowing animals may transport tailings material through the cover to the surface; and 4) plant roots may penetrate the cover, enter the tailings, and may accumulate metals and radio-nuclides which may enter the human food chain.

The sites which are not revegetated will not, in the early years after stabilization, be attractive to animals as a food source. However, many plant seeds are wind dispersed and will be deposited along with windblown soil particles. Therefore, natural plant colonization will gradually occur. These plants, particularly the early colonists, will produce large numbers of seeds which will become attractive to seed-eating, burrowing rodents.

Gano and States (1982) reviewed the available literature on preferred soil conditions and burrow characteristics of rodents in the families Sciuridae (squirrels), Heteromyidae (kangaroo rats and pocket mice), Geomyidae (pocket gophers), as well as badgers (Order Carnivora, family Mustelidae) that may invade the tailings covers in the west. Most burrowing rodents prefer fine soils, although several species are capable of burrowing through layers of rock (Cline et al., 1982), particularly if the rock is mixed with soils. Several species are also known to burrow to substantial depths, deep enough to reach tailings, if the cover is less than six meters thick (Table B.8.1).

Rodents burrowing through the cover could bring small quantities of tailings to the surface and provide pathways for radon gas to escape. If the cover is not penetrated, the burrow systems could still weaken the structure of the cover, particularly on the sides of the piles. Mammal burrows can also provide a pathway for deep water penetration into the cover, thereby increasing the likelihood of slumping or other structural breakdown. For these reasons, it is important that the presence of burrowing rodents in the tailings piles be recognized early.

Burrowing mammals deposit the excavated dirt and rock in small piles at burrow entrances. Some mammals leave characteristic, identifiable mounds on the surface. Other species leave very little sign other than a hole and can only be identified when trapped.

Table B.8.1 Burrowing rodents that may occur at the disposal site

Species	Reported burrowing depths (cm)	Soil preference
White-tailed antelope squirrel	30	Rocky
Gunnison's prairie dog	91 - 427	Fine
Botta's pocket gopher	5 - 35	Fine
Silky pocket mouse	52 - 62	Fine
Plains pocket mouse	35 - 61	Sandy loam
Ord's kangaroo rat (Ref. is Merriam)	26 - 175	Sandy loam
Deer mouse	---	-----
Northern grasshopper mouse	---	-----
Badger	150	Varied

Ref. Gano and States, 1982; Cline et al., 1982.

B.9 INTRUSION BY PLANTS

Plants growing on the sites will have positive and negative effects. The major positive effects are the reduction of erosion by binding soil particles with root systems, by absorbing the energy of raindrops, and by reduction of percolation into surface materials. Where plant cover is sporadic, however, the reduction in erosion is minor, and on engineered slopes occasional plants may accelerate erosion by channeling runoff and concentrating erosion. Deep-rooted species may provide openings by which water can penetrate deeply into the cover material, and thereby provide lubrication for sliding or initiate erosion.

Plants whose roots penetrate the cover may also actively transport metals or radionuclides from the tailings to the surface (Dreesen et al., 1978; Dreesen and Marple, 1979; Kelley, 1979). Such plant species will probably not become abundant on any of the tailings piles, but because they may introduce metals or radionuclides into the food chain, they are the plants of greatest interest during an inspection. Table B.9.1 lists some common species along with their recorded root depths.

Other deteriorating effects of plants are those indirect ones that result from plants being a precursor to animal invasion (Section B.9).

Table B.9.1 Plant species with deep root systems that have the potential for colonizing sites

Species	Common name	Tap root length (feet)	Soil type
<u>Salsola kali</u>	Tumbleweed	2.1	cl/sa
<u>Solanum eleagnifolium</u>	Horse-nettle	3.7	cl
<u>Chrysothamnus nauseosus</u>	Rabbitbrush	>12.8	sa/cl
<u>Franseria acanthocarpa</u>	Burweed	>5.0	sa
<u>Sphaeralcea parviflora</u>	Globe mallow	2.6	sa/cl
<u>Sarcobatus vermiculatus</u>	Greasewood	>9.8	si/cl

cl = clay; si = silt; sa = sand.

B.10 EXTREME NATURAL EVENTS

Several types of unusual events may conceivably destabilize disposal sites in a short period of time. These include:

<u>Event</u>	<u>Potential problems</u>
Major flood	Lateral stream cutting; headward stream erosion
Hurricane	Severe gullyng; landsliding
Tornado	Severe gullyng; landsliding; wind erosion
Extreme rainfalls or snowfalls	Severe gullyng; landsliding
Earthquakes or nearby explosions	Landsliding; cracking
Subsidence	Landsliding; cracking

Contingency inspections will be undertaken after any unusual or extreme event.

BIBLIOGRAPHY FOR APPENDIX B

- ASCE (American Society of Civil Engineers, publisher), 1976. "Evaluation of Seepage Stability of Dams," for Engineering Foundation Conference Proceedings, New York, New York.
- ASCE (American Society of Civil Engineers, publisher), 1974. "Inspection, Maintenance, and Rehabilitation of Old Dams," for Engineering Foundation Conference Proceedings, 1973, New York, New York.
- ASCE (American Society of Civil Engineers, publisher), 1974. "Safety Appraisals of Old Dams: An Undated Perspective," for Engineering Foundation Conference Proceedings, 1973, New York, New York.
- ASCE (American Society of Civil Engineers, publisher), 1973. "General Report on Seismic Hazards and Problems," for Engineering Foundation Conference Proceedings, New York, New York.
- ASCE (American Society of Civil Engineers, publisher), 1975. "Safety of Small Dams," in Engineering Foundation Conference Proceedings, 1974, H.N. Henniker, New York, New York.
- Ayers, Q.C., 1936. Soil Erosion and Control, McGraw Hill Book Company, Inc., New York and London.
- Bagnold, R.A., 1941. The Physics of Blown Sand and Desert Dunes, Methuen and Company, Ltd., London.
- Bailey, H.P., 1981. "Climatic Features of Deserts," in Water in Desert Ecosystems, D.D. Evans and J.L. Thomas, editors, US/IBP Synthesis Series II, Dowden, Hutchinson and Ross, Inc., Stroudsburg, Pennsylvania.
- Beasley, Robert Patrick, 1972. "Erosion and Sediment Pollution Control," Iowa State University Press, Ames, Iowa.
- Beaty, C.B., 1959. "Slope Retreat by Gullying," Geological Society of America Bulletin 70.
- Brady, N.C., 1974. The Nature and Properties of Soils, MacMillan Publishing Company, Inc., New York, New York.
- Bureau of Land Management, 1973. Manual of Instructions for the Survey of the Public Lands of the United States.
- Carson, M.A., and M.J. Kirkby, 1972. "Hillslope: Form and Process," Cambridge Geographical Studies 3.
- Chepil, W.S., 1945. "Dynamics of Wind Erosion: I. Nature of Movement of Soil by Wind," Soil Sciences, Vol. 60, pp. 305-320.
- Chepil, W.S., 1950. "Properties of Soil Which Influence Wind Erosion: The Governing Principle of Survey Roughness," Soil Sciences, Vol. 69, pp. 159-162.

- Cline et al. (J.F. Cline, F.G. Burton, D.A. Cataldo, W.E. Skiens, and K.A. Gano), 1982. Long-Term Bio-Barriers to Plant and Animal Intrusions of Uranium Tailings, report prepared by Pacific Northwest Laboratory, Richland, Washington, for the U.S. Department of Energy, UMTRA Project Office, Albuquerque Operations Office, Albuquerque, New Mexico, Microfiche-DOE/ UMT-0209, DE83000 305, PNL-4340, UC-70, Contract No. DE-AC06-75RLO-18830.
- Daubenmire, R.F., 1974. Plants and Environment: A Textbook of Plant Autecology, John Wiley and Sons, New York, New York.
- Dittmer, H.J., 1959. "A Study of the Root Systems of Certain Sand Dune Plants in New Mexico," Ecology, 40(2):265-273.
- Dreesen, D.R., and M.L. Marple, 1979. "Uptake of Trace Elements and Radionuclides from Uranium Mill Tailings by Four-Wing Saltbrush (Atriplex canescens) and Alkali Sacaton (Sporobolus airoides)," in Proceedings of the Second Annual Symposium on Uranium Mill Tailings Management, Colorado State University, Fort Collins, Colorado.
- Dreesen et al. (D.R. Dreesen, M.L. Marple, and N.E. Kelley), 1978. "Contaminant Transport, Revegetation and Trace Element Studies at Inactive Uranium Mill Tailings Piles," in Proceedings of the First Annual Symposium on Uranium Mill Tailings Management, Colorado State University, Fort Collins, Colorado.
- Eberhardt, Andrew, 1969. "Judgement Factors in Inspection of Dams," Water and Power, Volume 21, No. 11.
- Ekern, P.C., 1953. "Problems of Raindrop Impact Erosion," Agricultural Engineering, 34:23-25, 28.
- Free, G.R., 1952. "Soil Movement by Raindrops," Agricultural Engineering, 33:491-494, 496.
- Gano, K.A., and J.B. States, 1982. "Habitat Requirements and Burrowing Depths of Rodents in Relation to Shallow Waste Burial," DOE/UMT-0208, PNL-4140, UC-70, report prepared by Pacific Northwest Laboratory, Richland, Washington, for the U.S. Department of Energy, UMTRA Project Office, Albuquerque Operations Office, Albuquerque, New Mexico.
- Gupta, Horsh K., 1976. Dams and Earthquakes, Elsevier Scientific Publishing Company, Amsterdam and New York.
- Heil, R.D., 1977. An evaluation report on the study entitled Long-Term Erosion Losses on Reclaimed Tailings Disposal Site, Bear Creek Project, Wyoming, Argonne National Laboratory, Chicago, Illinois.
- Hoek, E., and J.W. Bray, 1977. Rock Slope Engineering, Second Edition.
- Kaliniske, A.A., 1942. "Criteria for Determining Sand-Transport by Surface-Creek and Saltation," Transaction of the American Geophysics, Union, 23: 639-643.

- Kelley, N.E., 1979. "Vegetational Stabilization of Uranium Spoil Areas, Grants, New Mexico," U.S. Department of Energy, Division of Biomedical and Environmental Research, LA-7624-T UC11, Los Alamos, New Mexico.
- Kirkby, M.J., 1967. "Measurement and Theory of Soil Creep," Journal of Geology, Volume 75, pp. 359-378.
- Leopold, L.B., W.W. Emmett, and R.M. Myrick, 1966. "Channel and Hillslope Processes on a Semi-Arid Area of New Mexico," U.S. Geological Survey, Professional Paper 352-G.
- Lindsey, C.G., J. Mishima, and S.F. King, 1982. "Evidence for Long-Term Stability of Uranium Mill Tailings: Survivability of Large Ancient Man-Made Earthen Structures," in Proceedings of the Fifth Annual Symposium on Uranium Mill Tailings Management, Colorado State University, Fort Collins, Colorado.
- Maner, Sam B., 1958. "Factors Affecting Sediment Delivery Rates in the Red Hills Physiographic Area," American Geophysical Union Transaction, 39(4), 669-675.
- Melton, M.A., 1957. "An Analysis of the Relations Among the Elements of Climate, Surface Properties, and Geomorphology," Columbia University Department of Geology Technology Department, 11.
- Miller, J.P., and L.B. Leopold, 1962. "Simple Measurement of Morphological Changes in River Channels and Hillslopes," Arid Zone Research, 20.
- Mosley, M.P., 1974. "An Experimental Study of Rill Erosion," Transactions of the American Society of Agriculture Engineering.
- Musgrave, G., 1947. "The Quantitative Evaluation of Factors in Water Erosion," Journal of Soil and Water Conservation.
- National Academy of Sciences, 1978. "Landslides: Analysis and Control," Robert L. Schuster and Raymond J. Krizek, (editors), Transportation Research Board, Commission on Sociotechnical Systems, National Research Council, Special Report 176, Washington, D.C.
- National Geodetic Survey, 1984. Publications of the National Geodetic Survey, Rockville, Maryland.
- National Research Council, 1973. "Erosion Control on Highway Construction," Highway Research Board, Washington, D.C.
- Potter, L.D., R.C. Reynolds, Jr., and E.T. Louderbough, 1979. "Properties of Mancos Shale Soils and Effects on Plant Communities," Manuscript on file, U.S. Department of Agriculture, Forest Service, Rocky Mountain Forest and Range Experiment Station, Contract No. 16-729-6R.
- Portland Cement Association (Publisher), 1956. "Soil Primer," Chicago, Illinois.

- Roehl, J.W., 1962. "Sediment Source Areas, Delivery Ratios, and Influencing Morphological Factors," International Association Science of Hydrology, Publication No. 59, 202-213.
- Schumm, S.A., 1956. "The Role of Creep and Rainwash in the Retreat of Badland Slopes," American Journal of Sciences, 254.
- Schumm, S.A., and R.F. Hadley, 1957. "Arroyos and the Semi-Arid Cycle of Erosion," American Journal of Sciences, 255, 161-174.
- Schumm, S.A., 1967. "Rates of Superficial Rock Creep on Hillslopes in Western Colorado," Science, Vol. 155.
- Schumm, S.A., and M.P. Mosley (editors), 1973. Slopes Morphology (Benchmark Papers in Geology), Stroudsburg, Pennsylvania.
- Schumm, S.A., M.D. Harvey, and C.C. Watson, 1983. Incised Channels: Morphology, Dynamics and Control, Water Resources Publications, Littleton, Colorado.
- Shannon, W.L., 1975. "Measurements of Lateral Movements in Soils," in Proceedings, 9th Canadian Soil Mechanics Conference, Ottawa, Canada.
- Sharpe, C.F.S., 1960. Landslides and Related Phenomena: A Study of Mass Movements of Soil and Rock, 2nd Edition, Pageant Books, Patterson, New Jersey.
- Sherard, James L., 1973. "Embankment Dam Cracking," Embankment Dam Engineering, Casagrande Volume, John Wiley and Sons, New York, New York.
- Smith, D.D., and W.H. Wischmeier, 1957. "Factors Affecting Sheet and Rill Erosion," Transactions of the American Geophysical Union, 38(6):889-96.
- Sokal, R.R., and F.J. Rohlf, 1981. Biometry, W. H. Freeman and Company, San Francisco, California.
- Stallings, J.H., 1951. "Mechanics of Wind Erosion," U.S. Department of Agriculture SCS-TP-108, Washington, D.C.
- Terzaghi, K., 1950. "Mechanism of Landslides," Berkey Volume, Geological Society of America, p. 83.
- "Uranium Mill Tailings Management," in Proceedings of the Third Annual Symposium on Uranium Mill Tailings Management, November 24-25, 1980, Colorado State University, Fort Collins, Colorado.
- U.S. Department of the Interior, Mining Enforcement Safety Administration, 1976. "Coal Refuse Inspection Manual," Denver, Colorado.
- U.S. Nuclear Regulatory Commission, 1977. "Design, Construction, and Inspection of Embankment Retention Systems for Uranium Mines," Regulatory Guide 3.11.
- Veder, Christian, 1981. Landslides and Their Stabilization, Springer-Verlog, New York, New York.

- Walters, M.H., 1983. "Overland Erosion of Uranium Mill Tailings Impoundments: Physical Processes and Computational Methods," prepared for the U.S. Nuclear Regulatory Commission, NUREG/CR-3027, PNL-4523, Washington, D.C.
- Wischmeier, W.H., and D.D. Smith, 1958. "Rainfall Energy and Its Relation to Soil Loss," Transactions of the American Geophysical Union, 39:285-91.
- Wischmeier, W.H., 1972. "Upslope Erosion Control," Environmental Impact on Rivers, H. W. Shen, (editor/publisher), Fort Collins, Colorado.
- Wischmeier, W.H., and D.D. Smith, 1978. "Predicting Rainfall Erosion Losses - A Guide to Conservation Planning," USDA Handbook, 537, U.S. Department of Agriculture, Washington, D.C.
- Zingg, A.W., 1940. "Degree and Length of Landslope as It Affects Soil Loss in Runoff," Agricultural Engineering, 21.
- Zingg, A. W., and W. S. Chepil, 1950. "Aerodynamics of Wind Erosion," Agricultural Engineering, 31:279-282, 284.
- Z'aruba, Quido, 1982. Landslides and Their Control, Elsevier Scientific Publication Company, Amsterdam and New York.

APPENDIX C
PHASE I INSPECTION CHECKLIST

PHASE I INSPECTION CHECKLIST

The Phase I inspection checklist that follows has been prepared and formatted as a general document, applicable to all mill tailings disposal sites following remedial action. The checklist is adaptable to each site's unique conditions. The adaptation will consist of such actions as:

- o Deleting inspection checks that do not apply and adding those not contemplated but needed because of unique design features.
- o Providing lists of off-site features that must be assessed in the field.
- o Providing specifics as to location of monuments, fences, signs, monitoring wells, and other site features.
- o Determining the minimum number of photos needed to document site conditions.

It must be noted that the checklist will be used by a team which may not have the experience to cover the multidiscipline subject areas. Therefore, the checklist must be complete and detailed to direct the inspection team to observe and record all pertinent data. The checklist must also be complete and detailed as it will become a legal record of responsible agency surveillance.

PHASE I INSPECTION CHECKLIST FOR THE
URANIUM MILL TAILINGS DISPOSAL SITE

Date of Last Inspection: _____

Reason for Last Inspection: _____

Responsible Agency: _____

Address: _____

Responsible Agency Official: _____

Inspection Start Date and Time: _____

Weather Conditions at Site: _____

Inspection Completion Date and Time: _____

Chief Inspector: _____

Name	Title	Organization
------	-------	--------------

Assistant Inspectors: _____

Name	Title	Organization
------	-------	--------------

Name	Title	Organization
------	-------	--------------

A. GENERAL INSTRUCTIONS

1. All checklist items must be completed and detailed comments made to document the results of the site inspection. The completed checklist is part of the field record of the inspection. Additional pages should be used as necessary to ensure that a complete record is made. Attach the additional pages and number all pages upon completion of the inspection.
2. Inspectors are to provide an up-to-date resume or vitae for inclusion in the inspection report.
3. Any checklist line item marked by an * that is checked by an inspector must be fully explained or an appropriate reference to previous reports provided. The purpose of this requirement is to provide a written explanation of inspector observations and the inspector's rationale for conclusions and recommendations. Explanations are to be placed on additional attachments and cross-referenced appropriately. Explanations, in addition to narrative, will take the form of sketches, measurements, and annotated site atlas overlays.

4. The site inspection is a walking inspection of the entire site, including the perimeter and sufficient transects to be able to inspect the entire surface and all features specifically described in this checklist. Every monument, site marker, sign, monitor well[, and erosion control marker] will be inspected.
5. A standard set of color print 35mm photographs is required. For this site, the standard set consists of _____ photographs. In addition, all anomalous features or new features (such as changes in adjacent area land use) are to be photographed. A photo log entry will be made for each photograph taken.
6. References to applicable sections of the SSMP are shown throughout the checklist in brackets.
7. Field notes taken to assist in completion of this checklist will become part of the inspection record. No form is specified: the field notes must be legible and in sufficient detail to enable review by succeeding inspectors and the responsible agency.

B. PREPARATION (To be completed prior to site visit)

- | | <u>Yes</u> | <u>No</u> |
|--|------------|-----------|
| 1. License (includes site surveillance and maintenance plan) reviewed. | _____ | _____* |
| 2. Site as-built plans reviewed and base map with copies of the following site atlas overlays obtained: | _____ | _____* |
| a. Adjacent off-site features and land use; fences, gates, and signs; access roads and paths. | | |
| b. Survey monuments, boundary markers, site markers, aerial photo ground controls, ground photo locations. | | |
| c. Monitor wells, site drainage, diversion channels. | | |
| d. Planned inspection transects and vegetation cover. | | |
| e. Others. | | |

These overlays will be used to identify site features and record, as appropriate, field data.

- | | | |
|--|--------|--------|
| 3. Previous inspection reports reviewed. | _____ | _____* |
| a. Were anomalies or trends in modifying processes detected on previous inspections? | _____* | _____ |

- | | <u>Yes</u> | <u>No</u> |
|---|------------|-----------|
| b. Was a Phase II inspection conducted? | ___* | ___ |
| c. Was custodial maintenance performed? | ___* | ___ |
| d. Was contingency repair work done as a result of the Phase II inspection? | ___* | ___ |
| 4. Site custodial maintenance and contingency repair records reviewed. | ___ | ___* |
| a. Has site contingency repair resulted in a change from as-built conditions? | ___* | ___ |
| b. Are revised as-builts available that reflect contingency repair changes? | ___ | ___* |
| 5. If required, adjacent property entry approval obtained (attach signed access agreement). | ___ | ___* |
| 6. Aerial photos taken since last inspection reviewed. For each set, enter date taken, scale, and if interpreted. | ___ | ___ |

<u>Set</u>	<u>Date</u>	<u>Scale</u>	<u>Interpreted</u>	
			<u>Yes</u>	<u>No</u>
1.	_____	_____	_____	_____
2.	_____	_____	_____	_____
3.	_____	_____	_____	_____

- | | <u>Yes</u> | <u>No</u> |
|--|------------|-----------|
| 7. Were any of the following suggested by examination of aerial photographs? (If yes, give photo set date and indicate if item noted by interpreter or inspector): | | |
| a. Intrusion by man? | ___* | ___ |
| b. Intrusion by animals? | ___* | ___ |
| c. Channelized erosion on slopes? | ___* | ___ |
| d. Change in area drainage? | ___* | ___ |
| e. Landslides? | ___* | ___ |
| f. Creep on slopes? | ___* | ___ |

- | | <u>Yes</u> | <u>No</u> |
|--|------------|-----------|
| g. Obstruction of diversion channels? | ___* | ___ |
| h. Bank erosion of diversion channels? | ___* | ___ |
| i. Seepage? | ___* | ___ |
| j. Cracking? | ___* | ___ |
| k. Change in vegetative cover? | ___* | ___ |
| l. Displacement of fences, site markers, boundary markers, or monuments? | ___* | ___ |
| m. Change in adjacent land use? | ___* | ___ |
| [n. Evidence of tailings exposure or transport? | ___* | ___] |

8. From as-builts, or subsequent inspection reports, note distance and azimuth from designated site location, such as a monument, to adjacent off-site features that could eventually affect integrity of site.

<u>Off-site feature</u>	<u>Site monument #</u>	<u>Distance</u>	<u>Azimuth</u>
1. _____	_____	_____	_____
2. _____	_____	_____	_____
3. _____	_____	_____	_____

9. Assemble and check out the following equipment needed to conduct inspections:
- a. Cameras, film, and miscellaneous support equipment.
 - b. Binoculars.
 - c. Tape measure.
 - d. Optical ranging device.
 - e. Brunton compass
 - f. Photo scale stick.
 - g. Erasable board.
 - h. Plant press, plastic bags for vegetation.
 - i. Keys to locks.
 - j. Bolt cutters.
 - [k. Hand lens.]
 - l. Others.

C. SITE INSPECTION

	<u>Yes</u>	<u>No</u>
1. Adjacent off-site features (within 0.25 mile of site boundary) (Township, Range, 1/4 1/4 Section).		
a. Have there been any changes in use of adjacent areas? (Grazing, construction, agriculture)	___*	___
b. Are there any new roads or trails?	___*	___
c. Has there been a change in the position of nearby stream channels?	___*	___
d. Has there been headward erosion of nearby gullies?	___*	___
e. Are there new drainage channels?	___*	___
f. Others?		
2. Access roads and paths, fences, gates, and signs (Section ___).		
a. Is there a break in the fence?	___*	___
b. Have any posts been damaged or their anchoring weakened?	___*	___
c. Is there evidence of erosion or digging beneath the fence?	___*	___
d. Does the gate show evidence of tampering or damage?	___*	___
e. Is there any evidence of human intrusion?	___*	___
f. Is there any evidence of large animal intrusion?	___*	___
g. Have any signs been damaged or removed? (Number of signs replaced: _____)	___*	___
h. Are access roads and paths passible?	___	___*
i. Others?	___*	___
3. Monuments and other permanent features (Section ___)		
a. Have the survey or boundary monuments been defaced or disturbed?	___*	___
b. Have the site markers been disturbed by man or natural processes?	___*	___

	<u>Yes</u>	<u>No</u>
c. Do natural processes threaten the integrity of any monument or site marker?	___*	___
d. Have aerial photo ground controls been disturbed?	___*	___
e. Others?		
4. Crests (Section ___)		
a. Is there evidence of uneven settling? (depressions, scarps)	___*	___
b. Is there cracking?	___*	___
c. Has the outer cover layer been breached?	___*	___
d. Is there evidence of erosion?		
(1) By water? (rills, rivulets)	___*	___
(2) By wind? (pedestal rocks, ripple marks)	___*	___
e. Is the vegetation cover as described in the as-builts?	___	___*
f. Is there evidence of animal burrowing?	___*	___
[g. Is there evidence of riprap or gravel deterioration?]	___*	___
h. Others?	___*	___
5. Slopes (Section ___)		
a. Is there evidence of gradual downslope movement (creep)? (terraces, deflection of plants)	___*	___
b. Is there cracking?	___*	___
c. Can depressions or bulges on the slope be seen?	___*	___
d. Has the outer cover layer been breached?	___*	___
e. Is there evidence of erosion:		
(1) By water?	___*	___
(2) By wind?	___*	___
f. Has water runoff become channelized? (rivulets, gullies)	___*	___

	<u>Yes</u>	<u>No</u>
g. Is there evidence of seepage? (moisture, color, vegetation)	___*	___
h. Has the vegetation cover changed significantly since the last inspection?	___*	___
i. Is there evidence of animal burrowing?	___*	___
j. Is there evidence of deterioration of riprap or gravel cover?	___*	___
k. Others?	___*	___
6. Periphery (within site boundaries) (Section ___)		
a. Is there evidence of seepage such as wet areas or localized change of vegetation?	___*	___
b. Is there evidence of sediment transport from the tailings pile by water or wind?	___*	___
c. Is the vegetation cover as described in the as-builts?	___	___*
d. Is the drainage as described in the as-builts?	___	___*
e. Others?		
7. Diversion channels (Section ___)		
a. Is there evidence of bank erosion?	___*	___
b. Has the integrity of riprap structures been disturbed by man or natural processes?	___*	___
c. Is there evidence of channel erosion?	___*	___
d. Is there evidence of sedimentation in the channel?	___*	___
e. Is the vegetation pattern in the channels consistent with that shown in the as-builts?	___	___*
f. Is the channel obstructed in any way?	___*	___
g. Is there any evidence that the diversion channels are not performing their function?	___*	___
h. Others?		

Yes No

8. Photography (Section ___)

- a. Have all photos required by the site atlas photo overlay been taken? ___ ___*
- b. Has a photo log sheet been prepared for each roll of film exposed. ___ ___*
- c. Number of rolls of film exposed: _____
- d. Others?

9. Monitor wells (Section ___)

- a. Have any monitor wells been disturbed by man or natural processes? ___* ___
- b. Does any natural process threaten the integrity of any monitor well? ___* ___
- c. Are all monitor wells' label plates intact and legible? ___ ___*
- d. Are all monitor wells capped and locked? ___ ___*
- e. Others?

D. FIELD CONCLUSIONS

- 1. Is there an imminent hazard to the integrity of the tailings pile? (Immediate report required)
Person _____
Agency to whom report made: _____ ___* ___
- 2. Are more frequent Phase I inspections required? ___* ___
- 3. Are existing contingency repair actions satisfactory? ___ ___*
- 4. Is a Phase II inspection required? ___* ___
- 5. Is contingency report or custodial maintenance required? ___* ___
- 6. Rationale for field conclusions _____

E. CERTIFICATION

I have conducted a Phase I inspection of the _____ uranium mill tailings site in accordance with the procedures of the license (includes the site surveillance and maintenance plan) as recorded on this checklist, attached sheets, field notes, photo log sheets, and photos.

Chief Inspector's Signature

Printed Name

Title

Date

(Stamp or Seal)

APPENDIX D
GROUND-WATER INSTRUCTIONS

TABLE OF CONTENTS

<u>Section</u>	<u>Page</u>
D.1 INTRODUCTION	D-1
D.2 WATER SAMPLING/PRESERVING/SHIPPING AND TESTING	D-3
D.2.1 Pre-field procedures.	D-3
D.3 FIELD PROCEDURES	D-9
D.3.1 Field measurements.	D-9
D.3.1.1 General.	D-9
D.3.1.2 pH	D-9
D.3.1.3 Temperature.	D-10
D.3.1.4 Electrical conductivity.	D-10
D.3.1.5 Alkalinity	D-11
D.3.1.6 Water level.	D-12
D.3.2 Sample collection	D-13
D.3.2.1 General.	D-13
D.3.2.2 Labeling and transport	D-15
D.3.2.3 Split samples.	D-15
D.3.2.4 Post field	D-16
D.4 QUALITY ASSURANCE REQUIREMENTS FOR FIELD PROGRAMS.	D-17
D.5 ANALYTICAL PROCEDURES AND LABORATORY QUALITY ASSURANCE	D-19
[D.5.1 Delivery of analyses and laboratory records	D-19
D.5.2 Sample lots and judging analyses.	D-21
D.5.3 Evaluation of accuracy.	D-21]
D.5.4 Unsatisfactory analyses	D-28
D.5.5 Evaluation of precision	D-29
REFERENCES FOR APPENDIX D.	D-31

LIST OF TABLES

<u>Table</u>		<u>Page</u>
D.2.1	Equipment checklist.	D-4
D.3.1	Sample bottle information.	D-14
D.5.1	Constituent list	D-20

D.1 INTRODUCTION

This appendix provides instructions to be followed by the responsible agency for the following aspects of ground-water monitoring:

- o Water sampling/preserving/shipping and testing.
- o Field procedures.
- o Sample collection.
- o Quality assurance requirements for field programs.
- o Analytical procedures and laboratory quality assurance.

D.2 WATER SAMPLING/PRESERVING/SHIPPING AND TESTING

Field programs consist of three parts: pre-field procedures, field measurements, and post-field procedures.

D.2.1 PRE-FIELD PROCEDURES

The following steps will be taken no less than 10 days before leaving for the field.

The pre-qualified analytical laboratory(ies) will be notified of:

- o Approximately how many samples [will be] received.
- o Approximately when the samples will be received.
- o The set of [analytes].
- o The type of bottles and preservatives to be provided (EPA, 1983), by the laboratory and where to send them.

Also, all equipment will be checked to ensure that it is working properly. Supplies of [bottles,] reagents, solutions, filters, and the like, will be checked to ensure there is enough on hand. [The types of bottles and preservatives will be consistent with recommendations of EPA (1983).]

These steps will be documented on the pre-field checklist (Table D.2.1).

Table D.2.1 Equipment checklist
 (Fill out all blanks prior to leaving for field)

<u>pH BUFFER</u>	<u>Yes</u>	<u>No</u>	<u>Comments</u>
sufficient volume 4	_____	_____	
sufficient volume 7	_____	_____	
sufficient volume 10	_____	_____	
vials for buffers	_____	_____	

REAGENTS & BOTTLES

Litmus paper	_____	_____
Nitric acid (pres.)	_____	_____
Sulfuric acid (pres.)	_____	_____
not required *	_____	_____
Other reagents	_____	_____
not required	_____	_____

Required sample bottles:

Number of 1000 ml plastic bottles for Al, M1, M2, Po210, Th230, N1, CN, S _____
 Number of 2000 ml plastic bottles for Pb-210, Ra-226, Ra-228 _____
 Number Of 500 ml plastic bottles for U, Gross Alpha, Gross Beta, N2 _____
 Number of 500 ml amber glass bottles for TOC _____
 Number of 1000 ml amber glass bottles for TOX _____]

Sufficient bottles _____

	<u>Yes</u>	<u>No</u>	<u>Comments</u>
Alkalinity kit	_____	_____	
ck reagent volumes	_____	_____	
ck glass for breakage	_____	_____	

<u>pH METER(s)</u>	<u>Martek</u>	<u>Ecologic</u>	<u>Comments</u>
ck electrode:			
full of fluid	_____	_____	
glass intact	_____	_____	
ck by immersing in tap water	_____	_____	

* if required, must explain under Comments.

** ck = check.

Table D.2.1 Equipment checklist (Continued)
 (Fill out all blanks prior to leaving for field)

<u>pH METER (cont'd)</u>	<u>Martek</u>	<u>Ecologic</u>	<u>Comments</u>
ck calibrate it rinse, fill, replace cap	_____	_____	
Temp probe: ck in tap water	_____ °C	_____ °C	
hot water	_____ °C	_____ °C	
 <u>Ec METER</u>			<u>Comments</u>
ck battery	ok _____	dead _____	
ck in tap water	ok _____	faulty _____	
ck against calibration solution	_____	_____	
calibration solution	_____	_____	
solution temp	_____	_____	
conductivity	_____	_____	
of solution	_____	_____	
 <u>HAND-HELD THERMOMETER</u>			
temp ice water	_____		
temp versus lab thermometer	_____		
 <u>OTHER EQUIPMENT</u>			<u>Comments</u>
squeeze bottle	_____		
acid dispensette	_____		
deionized H ₂ O quantity _____ gallons			
distilled H ₂ O _____ gallons			
sampling container	_____		

Table D.2.1 Equipment checklist (Continued)
(Fill out all blanks prior to leaving for field)

OTHER EQUIPMENT

Comments

water level sounder _____ battery check _____
hand tape _____
steel tape _____
blue chalk _____
cloth towels or wipes _____

FIELD FORMS AND MISCELLANEOUS EQUIPMENT:

Expected no. of samples _____ No. of forms _____
Clipboard with cover _____ Sample ticket book _____
Maps _____ marked with well locations _____
well information (completion, depth, etc.) _____
Field instruction book _____
Key(s) to well(s) _____ To be picked up at _____
Large clean bottles (3-5 gal.) _____
Large clean pails (3-5 gal.) _____
WD-40 (for locks) _____ transparent tape _____
Marking pen _____ Strapping tape (nylon) _____
Coolers _____ Blue ice _____

Shipping address of lab(s):

Phone numbers and contact:

Table D.2.1 Equipment checklist (Concluded)
(Fill out all blanks prior to leaving for field)

PUMPS AND FILTERS

Gas Pump

Pump:

last date used _____ Battery check _____

unit working ok _____ Power cord _____

logic unit _____ logic unit cord _____

regulator _____ wrenches _____

Hoses

condition _____ air hose _____
length _____

Peristaltic Pump

battery cable _____ Rechargeable battery _____

2 pump heads _____ Battery charges _____

clean? yes _____ no _____

tubing _____ length _____

Filter system:

pump nipple _____ Filter unit legs _____

Inspect filter housing for cracks _____

Number of filters _____ Filter size _____

Appropriate storage containers for all equipment _____

D.3 FIELD PROCEDURES

This section consists of two parts: field measurements and sample collection.

D.3.1 FIELD MEASUREMENTS

D.3.1.1 General

All field measurements and comments will be recorded on the water-quality field form (Figure 4.5). All lines on the field form will be completed. Steps not taken or not applicable will be so indicated in the appropriate space. The forms are to be completed with non-water-soluble ink, not felt tip type pens or pencils. If any procedures are not performed as prescribed, the reason must be stated on the field form.

[When practical,] final field measurements are to be taken after at least three bore volumes have been pumped from the well and as close to the time of sampling as is practicable.

D.3.1.2 pH

1. Connect the probe to the meter and immerse it in a flow through cell soon after pumping has begun. This will reduce or eliminate drift.
2. Bring the standard solutions to the temperature of the water in a flow through bath. If the meter has a temperature adjustment, set it to the temperature of the water.
3. Calibrate the meter immediately before taking the measurement. The calibrating solutions must bracket the sample: either pH = 2.0 and pH = 4.0, or pH = 7.0 and pH = 4.0, or pH = 7.0 and pH = 10.0.
4. Adjust the slope as follows:
 - o Put the probe in the pH = 7.0, or the pH = 4.0 solution if the pH is less than 4.0, and adjust the reading to 7.0 or 4.0.
 - o Put the probe in the other solution and adjust the reading to 2.00, 4.00, or 10.00 as appropriate.
 - o Repeat the above steps until adjustment is no longer required.
5. Clean the probe and that portion of cable which will be [inserted in the flow through bath] with distilled water and clean tissues.

6. Put the probe in a flow through cell. Record measurement within five minutes or after drift has ceased, whichever is sooner.
7. Immediately after taking the measurement, put the probe in each calibrating solution for about 30 seconds and record the readings.

Notes:

- o During storage and between measurements, keep the probe immersed in pH = 4.0 solution.
- o Rinse the probe in distilled water and pat dry with a clean tissue completely before putting it in a calibrating solution. Rubbing the probe may cause a static charge which will disrupt measurements.
- o Keep hoses leading to the flow through bath or cell out of direct sunlight as the water can heat up quickly at low discharge rates.

D.3.1.3 Temperature

Measure temperature in a small flow through cell. Record measurements periodically throughout the time of pumping.

Notes:

- o The field thermometer must be calibrated against a lab grade thermometer [prior to leaving for the field.]
- o Place [the flow through cell] close to the well head. Keep the cell and discharge hose out of direct sunlight.

D.3.1.4 Electrical conductivity

The conductivity meter will be calibrated with at least three standard solutions, the extremes of which bracket the samples. This will be done at least three times during the field program: before sampling, after the first day of sampling, and after sampling is completed. If there are significant differences between the first two calibrations, the meter must be calibrated each sampling day. A record of each calibration will be kept and the temperature of each calibrating solution will be recorded.

1. Clean probe and cable with distilled water and clean tissues.

2. Measure conductivity in a flow through cell. Record conductivity periodically throughout the time of pumping. Record the position of each setting on the meter.

Notes:

- o Rinse the probe in distilled water and dry it completely before putting it in a calibration solution.
- o Conductivity probes produce an electrical field which may be disturbed if the probe is near a solid object. Therefore, keep the probe at least two inches away from cell walls when making measurements in flow through cells. Keep lead weights at least six inches above the probe.

D.3.1.5 Alkalinity

- [1. Fill in header information on a titration form (Attachment 3).
2. Bring the temperature of the pH=4 and pH=7 standard buffer solutions to the temperature for the sample in a flow through bath. Standardize the meter with the electrode in each of these buffers according to the standard method. Leave the electrode in the pH=4 buffer solution.
3. Rinse the titration flask and volumetric flask with distilled water. Remove droplets of water by vigorous shaking.
4. Measure 100 ml of fresh, unfiltered sample in the volumetric flask and pour it into the titration flask with as little agitation as possible.
5. Rinse and pat dry the pH electrode and put it into the titration flask. Record the pH on the titration form (Attachment 3).
6. Record the titrant lot number on the titration form. Eject a few drops of titrant from the tip of the titrator and wipe the tip with a clean tissue. Reset the counter to 0000.
7. Titrate the solution with acid, gently stirring the solution to ensure mixing. Use magnetic stirrers when possible. Record pairs of pH and alkalinity readings for the pH values given on Attachment 3.
8. Rinse all glassware with distilled water.]

- [9. Plot the alkalinity and pH values on the titration plotting form.
10. Repeat the procedure with the other team member performing the titration.

11. Calculate the relative error as $\frac{X_1 - X_2}{X_s} \times 100\%$.

X_1 is the first alkalinity measurement at pH=4.5
 X_2 is the second alkalinity measurement at pH=4.5
 X_s is the lesser of X_1 and X_2 .

12. If the percentage error is greater than 10 percent, repeat the procedure until two consecutive measurements are within 10 percent relative error.

Note: The alkalinity value at the inflection point between pH=5 and pH=4 will be determined by the site hydrologist rather than the water sampling technician.

D.3.1.6 Water level

Measurement with an electrical sounder with markers at five- or 10-foot increments and a pocket tape measure marked in 1/100 feet is the preferred method.

Procedures are to:

1. Remove protective metal cap.
2. Remove protective plastic cap.
3. Drop probe of electrical sounder down the PVC casing until a current is detected on the meter.
4. Raise the probe until no current is detected, then slowly lower probe again just until a positive reading (jump) occurs.
5. Pinch the wire attached to the probe at the top of the PVC casing.
6. Measure the distance from the pinched spot to the nearest five- or 10-foot marker on the wire.
7. Record the depth at the five- or 10-foot marker plus or minus the measured distance.

D.3.2 SAMPLE COLLECTION

D.3.2.1 General

The upgradient wells will be sampled first. The order should be deeper to shallower and further from the stabilized tailings to closer. Then downgradient wells will be sampled using the same criteria for sampling order.

Samples will be taken after at least three bore volumes have been pumped from the well [(when practical)]. The field forms will be used to verify that the pH, temperature, and specific conductance have stabilized. When practical, field samples will not be collected until field parameters have stabilized.] Make a note of any odors, colors, and the like, that are noticed during pumping.

1. Drain pump hoses to ensure all old sample water is expelled.
2. Pump approximately two liters of distilled water through the hoses. Continue pumping until all distilled water is expelled.
3. Clean outside of hoses with distilled water and tissues before putting them down the hole. Set the intakes approximately one foot above the top of the screened interval.
4. Disassemble the filter apparatus and discard the old filter. Thoroughly rinse all surfaces which come in contact with the sample in distilled water.
5. With clean hands, install a new filter, touching it only along its perimeter. Allow no dirt or dust to blow onto the cleaned apparatus or filter. Re-assemble the apparatus.
6. Before taking any samples, run a few hundred ml of sample water through the filter.
7. Fill the sample bottles. Allow no dirt or dust to blow into bottles or bottle caps.
8. Add appropriate preservatives immediately after filling bottles. Note the amount and type. [(Note: Table D.3.1 lists acceptable bottle types, volumes, and preservation techniques for each analyte).]
9. Pour a few drops of acidified samples onto litmus paper to check the pH. If the pH is too high, add acid as appropriate and note the amount added.
10. Rinse inside of bottle caps with filtered sample and screw caps on tightly. Seal bottles with electrical tape or parafilm.

[Table D.3.1 Sample bottle information

Bottle I.D.	Bottle type	Volume (ml)	Preservation techniques	Analytes
A1	Polyethylene	1000	Filtered 4°C	F, Cl, SO ₄ PO ₄ , TDS
M1	Polyethylene	1000	Filtered, HCl to pH<2	Mo, Sb, Sn
M2	Polyethylene	1000	Filtered HNO ₃ to pH<2	B, Ba, As, Cd, Cr, Hg, Pb, Se, Al, Fe, Mn, Ag, Co, Cu, Ni, V Zn, U, Ca, Mg, Na, K, Sr
Pb-210	Polyethylene	2000	Filtered, HNO ₃ to pH<2	Pb-210
Po-210	Polyethylene	1000	Filtered HNO ₃ to pH<2	Po-210
Ra-226	Polyethylene	2000	Filtered HNO ₃ to pH<2	Ra-226
Ra-228	Polyethylene	2000	Filtered HNO ₃ to pH<2	Ra-228
Th-230	Polyethylene	1000	Filtered HNO ₃ to pH<2	Th-230
N1	Polyethylene	1000	H ₂ SO ₄ to pH<2, 4°C	NO ₂ +NO ₃ , NH ₄
CN	Polyethylene	1000	NaOH to pH>12, 4°C	CN
TOC	Amber Glass w/ teflon liner	500	4°C H ₂ SO ₄ to pH<2	TOC

Notes:

- o While filling, and once the sample is in the bottle, do not allow it to touch anything but the bottle walls. Never stick anything into the sample.
- o Do not smoke near open sample bottles.
- o Keep samples out of direct sunlight.
- o If the filter becomes clogged, replace it as above. Do not clean it, back flush it, and the like.

D.3.2.2 Labeling and transport

1. If bottles are unlabeled, label them with masking tape, wrapping the tape completely around the bottle. Include the following information: sample I.D., sample type, type and amount of preservative added, date and time sample taken, approximate electrical conductivity.
2. Immediately put the samples into an insulated container with ice or "blue ice."
3. Put the address and telephone number of the responsible agency and the name of a contact in the insulated container.
4. Tape the container with strapping tape for shipping. Ship the samples so they arrive at the lab no later than 36 hours after they were taken. Tell the lab when they will be arriving.
5. Schedule sampling so that samples do not arrive at the lab after 4 p.m. on a Friday or on a Saturday or Sunday.

D.3.2.3 Split samples

1. Thoroughly rinse the split jug with one gallon of distilled water. Drain through both the inlet and outlet tubes.
2. Pump approximately 10 liters of filtered sample water into the split jug. Rinse thoroughly and drain through both the inlet and outlet tubes.
3. Pump more than enough filtered water into the split jug to fill both sample sets. Swirl the jug to thoroughly mix the water.

4. Dispense sample types consecutively. That is, fill one lab's anion bottle immediately after the other's, one lab's metals bottle immediately after the other's, and so on.

D.3.2.4 Post field

1. Clean field equipment.
2. Replace expended items, filters, reagents, and the like.
3. Report and repair broken equipment.
4. Examine electrical conductivity and temperature calibrations. Adjust data as indicated and note on field forms.
5. Make copies of field forms to be archived.

D.4 QUALITY ASSURANCE REQUIREMENTS FOR FIELD PROGRAMS

Quality Assurance during drilling programs will be provided in four ways:

- o All field work will be performed in conformance with the specifications and procedures set forth in a scope of work.
- o The driller will keep a log of all drilling activities and achievements in a bound notebook.
- o Borehole/Well Construction Log (Figure 2.6) and the Well Completion Record (Figure 2.7) for each well will be completed in the field.
- o Continuous samples will be taken of all soil and rock encountered in each well. These samples will be archived by the responsible party.

Quality Assurance during hydraulic testing and water-sampling programs will be achieved in three ways:

- o A team of at least two technicians will be performing the testing at all times.
 - o All appropriate forms, the Ground-Water Sampling Record (Figure 4.5), Slug Test Data (Figure 4.9), and Static Ground-Water Level Record (Figure 4.6), will be completed in the field and signed by both technicians.
 - o The procedures of Appendix D.2 will be followed explicitly. If modifications have been approved by the responsible agency, then the procedures with modifications will be followed explicitly.
- [o At least one sample in ten will be split five ways from a common container.]

D.5 ANALYTICAL PROCEDURES AND LABORATORY QUALITY ASSURANCE

Only methods provided in EPA, 1983, or similar documents should be used for chemical analyses.

For quality assurance, all laboratories receiving and analyzing samples must be pre-qualified. The pre-qualification program is as follows:

- Step 1: Each prospective laboratory will be sent three (3) samples of known composition. These samples will be identical with those sent to all other laboratories involved in the pre-qualification program.
- Step 2: Each laboratory will analyze for all of the constituents set forth in Table D.5.1. Detection limits must be equal to or less than those specified. All analyses must be performed in the laboratory. None of the analyses may be performed by subcontracting support.
- Step 3: The results of the analyses in Step 2, except for those of radionuclides which require counting, must be reported to the responsible party not later than 14 days after receipt of the samples.
- Step 4: The responsible agency will determine the quality of the analyses through the accuracy [criterion]. A laboratory will lose one point for each result which fails to meet the criterion (see Step D.4.1).
- Step 5: Each analysis will be point scored (beginning with 100) and for each analysis which fails to meet the [criterion] one point will be deducted. The laboratories with the highest points will be selected to do the analysis.

Quality Assurance Program

This program applies to pre-qualified laboratories and assures quality during analysis of samples from sites. It establishes: deadlines for delivering analyses and quality control records; a method of grouping analyses and criteria for judging them; and procedures to be followed when analyses are unsatisfactory.

D.5.[1] DELIVERY OF ANALYSES AND LABORATORY RECORDS

The laboratory will deliver analyses, except for those of radionuclides which require counting, not later than 14 calendar days after it has received the samples.

The laboratory will provide the following information with each set of analyses submitted.

- o Methods of analysis.
- o Chain of custody.

Table D.5.1 Constituent list

Constituent	Detection limit (mg/l)	Constituent	Detection limit (mg/l)
Chloride (Cl)	1.0	Copper (Cu)	0.02
Sulfate (SO ₄)	0.1	Iron (Fe)	0.03
Sodium (Na) ⁴	0.002	Lead (Pb)	0.01
Potassium (K)	0.01	Manganese (Mn)	0.01
Magnesium (Mg)	0.001	Mercury (Hg)	0.0002
Calcium (Ca)	0.01	Molybdenum (Mo)	0.01
Boron (B)	0.1	Nickel (Ni)	0.04
Fluoride (F)	0.1	Selenium (Se)	0.005
Cyanide (CN)	0.01	Silver (Ag)	0.01
Hydrogen Sulfide (H ₂ S)	0.1	Strontium (Sr)	0.1
Ammonium (NH ₄)	0.1	Tin (Sn)	0.005
Nitrite (NO ₂)	0.1	Uranium (U)	0.003
Nitrate (NO ₃)	1.0	Vanadium (V)	0.01
Silica (SiO ₂)	2.0	Zinc (Zn)	0.005
Phosphate (PO ₄)	0.1	Total Dissolved Solids (TDS)	10
Aluminum (Al)	0.1	Total Organic Carbon (TOC)	0.1
Antimony (Sb)	0.003	Radionuclides	pCi/l
Arsenic (As)	0.01	Lead-210 (Pb-210)	1.5
Barium (Ba)	0.1	Polonium-210 (Po-210)	1.0
Cadmium (Cd)	0.001	Radium-226 (Ra-226)	1.0
Chromium (Cr)	0.01	Radium-228 (Ra-228)	1.0
Cobalt (Co)	0.05	Thorium-230 (Th-230)	1.0

- o Records of analyses of laboratory quality control standards and reagent blanks.
- o Records of spikes and duplicate/replicate runs.

D.5.[2] SAMPLE LOTS AND JUDGING ANALYSES

Samples will be grouped into lots. A lot is a group of samples associated with one or more solutions of known composition. Lots will consist of no more than [eight] samples, plus known solutions[, plus one sample split five ways.] Known solutions will be shipped to the laboratory along with the lot and [will] be indistinguishable from the samples.

Analyses of known solutions will be judged against the accuracy criteria. Any faults found in these analyses will be assumed to exist in every analysis of the lot.

The cation-anion balance of every analysis will be judged against the cation-anion balance criterion (see Section D.5.6).

[D.5.3] EVALUATION OF ACCURACY

A solution of known composition will be associated with each sample lot. The accuracy criteria require that the reported value of each constituent in a known solution fall within an acceptable range. If the reported value is unacceptable, all analyses for that constituent in the entire lot [will be] unacceptable. The evaluation will be performed as follows.

- o The acceptable range of each constituent in the known solution will be computed.
- o The reported values will be compared with the ranges computed above.
- o If all reported values fall within their acceptable ranges, the lot will be acceptable with respect to the accuracy evaluation.
- o If the reported values of any constituents fall outside their acceptable ranges, the laboratory will be instructed to re-analyze the entire lot for those constituents.
- o If any reported values from re-analysis do not fall within their acceptable ranges, the laboratory may choose to perform further re-analysis. The entire lot will be unacceptable with respect to a given constituent until the re-analyzed value falls within its acceptable range.

CALCULATIONS

Calculation of the acceptable ranges for reported values of known solutions will be as follows:]

[(1) To account for the uncertainty in preparing the known solution. The known concentration may vary from:

$$X (1-U) \text{ to } X (1+U)$$

where

X = known concentration
U = uncertainty

(2) Next, use the allowable "% wrong" from the attached accuracy criteria to calculate the acceptable range.

$$\text{Acceptable Range} = \left(\frac{X(1-U)}{\frac{\% \text{ wrong}}{100} + 1} \right) \text{ to } \left(\frac{\% \text{ wrong}}{100} + 1 \right) X(1+U)$$

Where:

When the reported concentration (RC) is greater than the known concentration:

$$\% \text{ wrong} = \left(\frac{RC}{X} - 1 \right) 100,$$

When the RC is less than the known concentration:

$$\% \text{ wrong} = \left(\frac{X}{RC} - 1 \right) 100,$$

Where:

RC = reported concentration
x = known concentration

If a constituent is incorrectly reported as being below the detection limit, the detection limit will be used as the reported concentration in the above equation.

EXAMPLE:

The known concentration of Cl in a known solution is 36 mg/l ± 3%.

The known concentration may vary from:

$$36 \text{ mg/l } (1-0.03) \text{ to } 36 \text{ mg/l } (1+0.03) = 34.9 \text{ mg/l to } 37.1 \text{ mg/l}$$

From the accuracy criteria, Group III, (see page D-24) for concentrations greater than 1 mg/l, the allowable % wrong is 10.

The acceptable range is:]

$$\left(\frac{34.9 \text{ mg/l}}{\frac{10}{100} + 1} \right) \text{ to } \left(\frac{10}{100} + 1 \right) 37.1 \text{ mg/l} = 31.7 \text{ mg/l to } 40.8 \text{ mg/l}$$

Any reported value out of this range is unacceptable.

Criteria for Approval of Analyses

Accuracy

Group I: Sb, As, Ba, Cd, Cr, Pb, Hg, Mo, Se, U, Pb-210*, Po-210*, Ra-226*, Ra-228*, Th-230*.

The analysis of a Group I constituent in a solution of known concentration is unsatisfactory if:

For concentrations <0.01 mg/l, the reported value is wrong by more than 100 percent;

-OR-

For concentration > 0.01 mg/l, <0.1 mg/l, the reported concentration is wrong by more than 50 percent;

-OR-

For concentrations > 0.1 mg/l, <1 mg/l, the reported concentration is wrong by more than 25 percent;

-OR-

For concentrations >= 1 mg/l, the reported concentration is wrong by more than 10 percent.

If a constituent is incorrectly reported as being below the detection limit, that limit will be used as the reported concentration in the above equation.

*Convert Radioactivity (pCi) to mass (mg) as follows.

<u>RADIONUCLIDE</u>	<u>CONVERSION</u>
Pb-210	1.31×10^{-11} mg/pCi
Po-210	2.23×10^{-13} mg/pCi
Ra-226	1.01×10^{-9} mg/pCi
Ra-228	3.67×10^{-12} mg/pCi
Th-230	5.15×10^{-8} mg/pCi

Group II: B, CN, H₂S, NH₄, NO₂, PO₄, Co, Cu, Ni, Ag, Sr, Sn, V, Zn, TOC.

The analysis of a Group II constituent in a solution of known concentration is unsatisfactory if:]

[For concentration <0.01 mg/l, the reported value is wrong by more than 200 percent;

-OR-

For concentrations >0.01 mg/l, <0.1 mg/l, the reported concentration is wrong by more than 100 percent;

-OR-

For concentrations >0.1 mg/l, <1 mg/l, the reported concentration is wrong by more than 50 percent;

-OR-

For concentration ≥ 1 mg/l, the reported concentration is wrong by more than 20 percent.

If a constituent is incorrectly reported as being below the detection limit, that limit will be used as the reported concentration in the above equation.

Group III: Cl, SO₄, NO₃, NH₄, K, Mg, Ca, F, Al, Fe, Mn, SiO₂, TDS.

The analysis of a Group III constituent in a solution of known concentration is unsatisfactory if:

For concentrations <0.01 mg/l, the reported value is wrong by more than 200 percent;

-OR-

For concentrations >0.01 mg/l, <0.1 mg/l, the reported concentration is wrong by more than 100 percent;

-OR-

For concentrations >0.1 mg/l, <1 mg/l, the reported concentration is wrong by more than 50 percent;

-OR-

For concentration ≥ 1 mg/l, the reported concentration is wrong by more than 10 percent.

EVALUATION OF CATION-ANION BALANCES

- (1) The cation-anion balance of each field sample (not known solutions) will be computed.
- (2) If the analysis satisfies the balance criterion it is acceptable.
- (3) If the analysis does not satisfy the balance criterion, the laboratory will be instructed to re-analyze the sample for constituents of its own choosing.]

[The above steps will be completed no later than 14 days after analyses are received.

- (4) If the re-analysis does not satisfy the balance criterion, the laboratory may choose to re-analyze the sample. The entire sample analysis is unacceptable unless it satisfies the balance criterion.

CALCULATIONS

(1) Alkalinity Calculations

- (a) Because accurate measurements of alkalinity are critical, the following procedure will be used:

o Each time a site is sampled, three solutions of known but different alkalinity will be sent to the water samplers in the field. The team will measure and record their alkalinity values.

o Inaccuracies in the reported values will be taken into account when computing cation-anion balance (see example in this section).

- (b) If sample pH < 8.3.

$$\text{mg/l HCO}_3 = \text{field alkalinity (as mg/l CaCO}_3) \times 1.22$$

- (c) If sample pH > 8.3

Find ratio of HCO₃ to CO₃;

$$\frac{\text{HCO}_3}{\text{CO}_3} = \text{Antilog (10.3-pH)} = A$$

$$R_{\text{HCO}_3} = \frac{A}{A+1}$$

$$R_{\text{CO}_3} = 1 - R_{\text{HCO}_3}$$

Then:

$$\text{mg/l HCO}_3 = \frac{R_{\text{HCO}_3}}{R_{\text{HCO}_3} + 2R_{\text{CO}_3}} = (1.22) \text{ ALK (as mg/l CaCO}_3)$$

And:

$$\text{mg/l CO}_3 = \frac{R_{\text{CO}_3}}{R_{\text{HCO}_3}} = (\text{mg/l HCO}_3) \frac{60}{61}$$

[(2) Convert concentrations from mg/l to meq/l by dividing them by constituent equivalent weight. Consider only those constituents which comprise more than 0.1 percent of the sample's TDS. Compute for both oxidizing and reducing conditions.

(3) Calculate relative balance error:

$$\frac{\Sigma \text{meq Cations} - \Sigma \text{meq Anions}}{\Sigma \text{meq Cations} + \Sigma \text{meq Anions}} \times 100$$

Use the values which result in the lowest absolute values, i.e., an alkalinity value and values for oxidizing conditions, or, an alkalinity value and values for reducing conditions. If the absolute values of the sample's balance error is greater than 5 percent, the sample analysis is unacceptable.

EXAMPLE

(1a) For a given sample, the reported alkalinity is 323 mg/l as CaCO₃.

A comparison of field analysis and known alkalinity values show:

<u>Field Value</u> (mg/l as CaCO ₃)	<u>True Value</u> (mg/l as CaCO ₃)	<u>Uncertainty</u> (+%)
22.7	21.1	8
362	377	4
914	920	1

The reported alkalinity of 323 mg/l is nearest to the true value of 377 mg/l therefore, an uncertainty of + 4 percent will be used in the cation-anion calculation. The alkalinities used to calculate the balance will be 310 mg/l as CaCO₃ and 336 mg/l as CaCO₃.

(1b) The sample pH is <9.5:

$$\text{mg/l HCO}_3 = 310 (1.22), 336 (1.22) = 378 \text{ mg/l}, 410 \text{ mg/l}$$

(2) The sample's TDS is 2520 mg/l. Only those constituents with reported concentrations greater than 2.52 mg/l will be used to calculate the balance.]

[CATIONS

Constituent	Concentration (mg/l)	Oxidizing conditions (mg/l)	Reducing conditions (mg/l)
Ca	595	29.69	29.69
Fe	26.1	1.40	0.93
Mg	44.3	3.65	3.65
Mn	7.01	0.51	0.26
K	6.26	0.16	0.16
Na	19.2	0.84	0.84
		36.25	35.53

ANIONS

Constituent	Concentration (mg/l)	Oxidizing conditions (mg/l)	Reducing conditions (mg/l)
Cl	19	0.54	0.54
SO ₄	1490	31.02	31.02
HCO ₃	378,410	6.19*	6.19*
		37.75	37.75

*378 mg/l was used because it will result in the lowest absolute value in the balance.

(3) The Balance of Oxidizing Conditions is:

$$\left(\frac{36.25 - 37.75}{36.25 + 37.75} \right) 100 = 2.03\%$$

For Reducing Conditions:

$$\left(\frac{35.53 - 37.75}{36.25 + 37.75} \right) 100 = 3.03\%$$

The analysis is acceptable because the lowest balance error, 2.03 percent for oxidizing conditions, is less than 5 percent. The error for reducing conditions also is acceptable.]

D.5.4 UNSATISFACTORY ANALYSES

Imperfect Lots

A lot is imperfect if:

- o The analysis of one sample does not satisfy the cation-anion balance criterion;

-OR-

- o Up to 10 percent of the analyses of constituents in the known solution do not satisfy the accuracy criteria.

When the balance criterion is not satisfied, the laboratory will re-do the unsatisfactory analysis.

When accuracy criteria are not satisfied, the laboratory will re-analyze the entire lot for those constituents whose analyses did not satisfy the criteria.

Unacceptable Lots

A lot is unacceptable if:

- o The analyses of two or more samples do not satisfy the cation-anion balance criterion;

-OR-

- o More than 10 [percent] of analyses of constituents in the known solution do not satisfy the accuracy criteria.

The laboratory will be required to deliver, within 72 hours, a written explanation of the causes of the unsatisfactory analyses and a statement of the measures it will take to prevent them in the future.

Then, if it appears that re-analysis will produce accurate results, the laboratory will be directed to re-analyze the entire lot for designated constituents.

If it does not appear that re-analysis will produce accurate results, the laboratory will not be paid for the lot. It will be directed to ship the lot, in the same manner as it was received, to another qualified laboratory.

Disqualification

If more than 20 [percent] of a laboratory's analyses of lots are unacceptable, the laboratory will be disqualified. It may be requalified if it repeats, and is selected through, the pre-qualification procedure.

D.5.5 EVALUATION OF PRECISION

The analytical precision of splits will be evaluated to supplement the accuracy and cation-anion balance criteria and aid in identifying analytical problems.

CALCULATIONS

Precision will be evaluated using the coefficient of variation of the splits.

The coefficient of variation (C_v) is the standard deviation (s) / the arithmetic mean (\bar{x}).

$$s = \left[\frac{\sum_{i=1}^n (x_i - \bar{x})^2}{n-1} \right]^{1/2}$$

where:

n = number of values
 x_i = an individual i^{th} value

$$\bar{x} = \frac{1}{n} \sum_{i=1}^n x_i$$

The following table lists the maximum acceptable C_v 's for a given allowable "% wrong" from the lists in section D.5.3.

<u>% Wrong</u>	<u>C_v</u>
200	1.38
100	0.84
50	0.45
20	0.18
10	0.09

These coefficients of variation were calculated for four values at the lower limit of the acceptable range and one value at the upper limit of the acceptable range.

EXAMPLE

The laboratory reports the following Mn values for 5 splits (mg/l) 0.03, 0.007, 0.02, 0.03, 0.009. The arithmetic mean (\bar{x}) for these five values is 0.0192. The standard deviation is 0.110318 therefore, the coefficient of variation (C_v) is 0.575. From section D.5.3, for an Mn concentration of 0.0192 mg/l, the maximum acceptable "% wrong" is 100 percent. The maximum acceptable C_v is then 0.84. The precision for these five Mn concentrations is therefore adequate.]

REFERENCES FOR APPENDIX D

EPA (U.S. Environmental Protection Agency), 1983. Methods for Chemical Analysis of Water and Wastes, EPA-600/4-79-020, revised 1983.

APPENDIX E
AERIAL PHOTOGRAPHY QUALITY ASSURANCE

TABLE OF CONTENTS

<u>Section</u>		<u>Page</u>
E.1	VERTICAL AERIAL PHOTOGRAPHS.	E-1
E.1.1	Crab	E-1
E.1.2	Flight lines	E-1
E.1.3	Labeling	E-1
E.1.4	Overlap.	E-1
E.1.5	Processing of exposed film	E-2
E.1.6	Quality of photography	E-2
E.1.7	Scale of photography	E-3
E.1.8	Tilt	E-3
E.1.9	Unexposed film	E-3
E.1.10	Weather and sun angle.	E-3
E.2	OBLIQUE AERIAL PHOTOGRAPHS	E-5
E.2.1	Processing of exposed film	E-5
E.2.2	Quality of photography	E-5
E.2.3	Tilt angle for obliqueness	E-5
E.2.4	Weather and sun angle.	E-5
E.3	QUALITY CONTROL OF AERIAL PHOTO INTERPRETATION	E-7
	REFERENCES FOR APPENDIX E.	E-9

E.1 VERTICAL AERIAL PHOTOGRAPHS

The vertical aerial photographs will be examined prior to final acceptance by the responsible agency to determine if the photographs meet criteria and specifications as discussed below:

E.1.1 CRAB

Crab in excess of five degrees may be cause for rejection of the flight line of negative or portions thereof in which such crab occurs.

E.1.2 FLIGHT LINES

Flight lines will be designed for the photography, and will be delineated on a suitable map or photographic mosaic. This will be done to obtain proper sidelap of one flight-line strip of vertical photography on another, and to assure full stereoscopic photographic coverage. Generally, the flight lines will be parallel to each other and to the lengthwise boundary lines of the area to be photographed.

E.1.3 LABELING

Each negative will be labeled clearly with a designation symbol, followed by the film roll number and the negative number. The negative numbers will be sequential within each roll, or will be consecutive for the entire project. The designation symbol, the film roll number, and the negative number will be in the upper right corner of the photograph printed from each negative to be read as one looks northerly along the flight line (or easterly if lines are east-west). The date of photography will be in the upper left corner. On the end negatives of each flight line, there will also be labeled the aircraft flight height in feet above the average elevation of the ground, the focal length in millimeters of the aerial camera, and clock time of day.

All lettering and numbering on the negative will be one-fifth inch high, and will result in easily read, sharp, and uniform letters and numbers on all photographs (both contact prints and enlargements) printed from the negatives.

E.1.4 OVERLAP

The overlap will be sufficient to provide full stereoscopic coverage of the area that will be photographed, as follows:

- o Boundaries - All of the area appearing on the first and the last negative in each flight line extending over a boundary will be outside the boundary of the project area. Each strip of photographs along a boundary will extend over the boundary not less than 15 percent or more than 55 percent of the width of the strip.

- o Endlap - The endlap (overlap in line of flight) will average not less than 57 percent or more than 62 percent. Endlap of less than 55 percent or more than 68 percent in one or more negatives may be cause for rejection of the negative or negatives in which such deficiency or excess of endlap occurs; unless, within a stereoscopic pair, endlap exceeding 68 percent is necessary in areas of low elevations to attain the minimum 55 percent endlap in adjacent areas of higher elevation.

Wherever there is a change in direction of the flight lines, vertical photographs at the beginning of a flight line will give complete stereoscopic coverage of the area contiguous to the forward and back sections.

- o Sidelap - The sidelap (overlap of parallel strips of vertical photographs) should average 25 percent, plus or minus 10 percent. Any negatives having sidelap less than 15 percent or more than 50 percent may be rejected.
- o Substitute photography - In flight lines rephotographed to obtain substitute photography for rejected photography, all negatives will be exposed to comply with other overlap requirements, and the joining end negatives in the replacement strip will result in complete stereoscopic coverage of the contiguous area on the portion or portions not rejected.

E.1.5 PROCESSING OF EXPOSED FILM

The processing, including development fixation, and washing and drying of all exposed photographic film, will be according to the manufacturer's recommendations using fresh chemistry and will result in negatives free from chemical and other stains, containing normal and uniform density, and fine-grain quality. Before, during, and after processing, the film will not be rolled tightly on drums or in any way stretched, distorted, scratched, or marked, and will be free from finger marks, dirt, or blemishes of any kind. Film and prints may be subject to testing for residual traces of hypo (sodium-thiosulphate) or other processing chemicals.

E.1.6 QUALITY OF PHOTOGRAPHY

The photographic negatives will be taken so as to prevent appreciable image movement at the instant of exposure. Exposure and processing will be such that the negatives will be of high quality showing the demarcation of planimetric and topographic features discernible at the required scale. The negatives will be free from static marks, will have uniform color tone, and will have the proper degree of contrast for all details to show clearly in the dark-tone areas and high-light areas as well as in the half tones between the dark and the high light. Negatives having excessive contrast or negatives low in contrast may be rejected.

E.1.7 SCALE OF PHOTOGRAPHY

The flight height above the average elevation of the ground will be such that the negatives will have the average scale specified. Negatives having a departure from that scale of more than five percent because of tilt or any changes in flight height must be replaced. A wider range of accuracy will be allowed for areas with vertical relief in excess of 150 degrees.

E.1.8 TILT

Negatives made with the optical axis of the aerial camera in a vertical position are desired. Tilt (angular departure of the aerial camera axis from a vertical line at the instant of exposure) in any negative of more than two degrees, an average tilt of more than one degree for the entire project, or tilt between any two successive negatives exceeding three degrees, may be cause for rejection.

E.1.9 UNEXPOSED FILM

Whenever any part of an unexposed roll of film remains in the camera, before such film is used on a subsequent day, a minimum three-foot section of the roll of film will be rolled forward unexposed immediately preceding the beginning of photography.

E.1.10 WEATHER AND SUN ANGLE

Photography will be undertaken only when well-defined images can be obtained. Photography will not be attempted when the ground is obscured by haze, smoke, or dust, or when clouds or cloud shadows will appear on more than five percent of the area of any one photograph. Photography will not contain shadows caused by topographic relief and sun angle, whenever such shadows can be avoided during the time of the year the photography must be taken. Photography will not be undertaken when the sun angle is less than 25 degrees above the horizon.

If the prints display conditions beyond the acceptable ranges described, the photos may be rejected.

E.2 OBLIQUE AERIAL PHOTOGRAPHS

The oblique photographs will be subject to the following specifications:

E.2.1 PROCESSING OF EXPOSED FILM

The processing, including development and fixation, and washing and drying of all exposed photographic film, will be conducted according to the manufacturer's recommendations using fresh chemistry and will result in negatives free from chemical and other stains, containing normal and uniform density, and fine-grain quality. Before, during, and after processing, the film will not be rolled tightly on drums or in any way stretched, distorted, scratched, or marked, and shall be free from finger marks, dirt, or blemishes of any kind. Films may be subject to testing for residual traces of residual chemicals.

E.2.2 QUALITY OF PHOTOGRAPHY

The photographic negatives will be taken so as to prevent appreciable image movement at the instant of exposure. Exposure and processing will be such that the negatives will be of high quality, showing the demarcation of planimetric and topographic features.

The negatives will be free from static marks, will have uniform color tone, and will have the proper degree of contrast for all details to show clearly in the dark-tone areas and high-light areas as well as in the half tones between the dark and high light. Negatives having excessive contrast or negatives low in contrast may be rejected.

E.2.3 TILT ANGLE FOR OBLIQUENESS

The tilt angle will be such that the designated area or site will be satisfactorily shown on the negative(s).

E.2.4 WEATHER AND SUN ANGLE

Photography will be undertaken only when well-defined images can be obtained and not when the area or site to be photographed is obscured by haze, smoke, or dust. The photography will not contain shadows detrimental to photographic composition which are caused by the effect of the sun angle on topographic relief, on tall buildings, or on clouds.

E.3 QUALITY CONTROL OF AERIAL PHOTO INTERPRETATION

The best quality control of photo interpretation will be maintained by utilizing interpreters with extensive experience in identifying geomorphic and vegetative features. A quantitative method of evaluating the skill of interpreters has been developed by Congalton and Mead (1983). This method involves giving each interpreter the same set of photos to interpret and then generating a similarity matrix for each interpreter based on actual documented ground conditions. The similarity matrix is analyzed using a computer code (Kappa) which implements a discrete multivariate analysis technique to determine if there is a significant difference between matrices. This technique facilitates the comparison of individual interpreters, a test for photo interpreter consistency, and the comparison of photo interpretation variables. Aerial photographs with reference features from the initial aerial photo survey would be useful in administering such a test. Test results could be used to select the best photo interpreters for the surveillance program and as an ongoing quality assurance technique.

Comparison of annual ground inspections with photo interpretation results will be a useful cross-check to verify site conditions.

An additional quality assurance technique is an independent review by an outside professional photo interpreter.

REFERENCES FOR APPENDIX E

Congalton, R. G., and R. A. Mead, 1983. "A Quantitative Method to Test for Consistency and Correctness in Photo Interpretation," in Photogrammetric Engineering and Remote Sensing, Vol. 49, pp. 69-74.

END

DATE FILMED

02 / 07 / 91

