

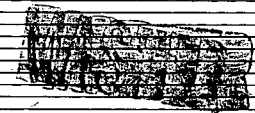

Office of Nuclear Regulatory Research
U.S. Nuclear Regulatory Commission

Working Safely in Gamma Radiography

2



DO NOT MICROFILM
COVER

RECEIVED BY THE SEP 22 1972

REPRODUCTION OF THIS GRAPHIC IS PROHIBITED

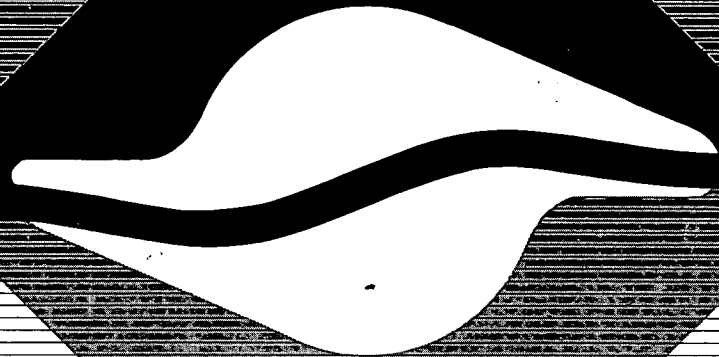

DISCLAIMER

This report was prepared as an account of work sponsored by an agency of the United States Government. Neither the United States Government nor any agency Thereof, nor any of their employees, makes any warranty, express or implied, or assumes any legal liability or responsibility for the accuracy, completeness, or usefulness of any information, apparatus, product, or process disclosed, or represents that its use would not infringe privately owned rights. Reference herein to any specific commercial product, process, or service by trade name, trademark, manufacturer, or otherwise does not necessarily constitute or imply its endorsement, recommendation, or favoring by the United States Government or any agency thereof. The views and opinions of authors expressed herein do not necessarily state or reflect those of the United States Government or any agency thereof.

DISCLAIMER

Portions of this document may be illegible in electronic image products. Images are produced from the best available original document.

NUREG/BR--0024

DE82 905450

September 1982

Authors

Stephen A. McGuire

A health physicist and specialist in industrial radiography in NRC's Occupational Radiation Protection Branch, Office of Nuclear Regulatory Research. He received a Ph.D. in Nuclear Engineering in 1970 from the University of Wisconsin.

Carol A. Peabody

A technical writer and project coordinator in NRC's Program and Administrative Services Branch, Office of Nuclear Regulatory Research. She received her B.A. in journalism in 1968 from the University of Washington.

MASTER

Disclaimer

Equipment shown in the figures in this manual is used solely for illustrative purposes. The inclusion of such equipment in the figures does not imply any endorsement of the equipment by the NRC.

This document is
PUBLICLY RELEASABLE

Bamy Steele
Authorizing Official
Date: 7-30-07

DISTRIBUTION OF THIS DOCUMENT IS UNLIMITED

Available as NUREG/BR-0024
U. S. Nuclear Regulatory Commission
Washington, D.C. 20555

For sale by the Superintendent of Documents,
U.S. Government Printing Office, Washington, D.C. 20402

Contents

Preface

Who Is This Manual For?	iv
-------------------------------	----

Chapter

1 Why Is Safety Training Important?	1
2 What Is Radiation?	7
3 What Is Radioactivity?	17
4 What Are the Harmful Effects of Radiation?	25
5 How Do Time, Distance, and Shielding Affect Your Dose?	41
6 How Do You Detect and Measure Radiation?	63
7 How Do Radiography Cameras Work?	77
8 What Are the Basic Rules for Radiography?	85
9 What Are the Rules for Transporting Sources?	99
10 How Can Following Procedures Help You?	109
11 Why Do Radiography Accidents Happen?	115

Appendices

A Regulatory Agencies in Agreement States	125
B NRC Regional Offices	127
C How To Obtain NRC Regulations and Guides	129
D NRC Forms	131
E Glossary	133
F Overexposure Accidents, 1971-1980	149
G References and Notes	155
H Photo Credits and Acknowledgments	161

Who Is This Manual For?

This manual* is designed for classroom training in working safely in industrial radiography using radioactive sources that emit gamma rays. Industrial radiography using x-ray machines, accelerators, and neutron sources is not covered in this manual.

The purpose of this manual is to help train you — a radiographer's assistant — to work safely as a qualified gamma radiographer. This training is important to help you work competently as a radiographer and to help you prevent radiography accidents.

Industrial radiography using gamma ray sources is regulated by the U.S. Nuclear Regulatory Commission (NRC) or, in many states, by the individual states themselves. Industrial radiography using x-ray machines and accelerators is regulated by state regulatory agencies or by the federal Occupational Safety and Health Administration (OSHA).

This manual was written to assist your company in meeting the NRC's requirements on training radiographers. NRC regulations** require that individuals receive radiation safety training and pass both a written test and a field test before becoming gamma radiographers. Each state that regulates gamma radiography has an equivalent requirement. This manual covers the general subjects that the NRC requires you to know about gamma radiography safety. Additional information on case histories of radiography accidents is available from the NRC.***

The radiography safety training information in this manual is intended to be taught by a qualified instructor using 30 to 40 classroom hours of instruction. This manual is not intended for self-instruction. The instructor will be able to answer specific questions on equipment and procedures and will allow ample time for discussion with fellow students.

This manual does *not* cover your company's specific operating and emergency procedures. Your company's procedures for equipment operation, inspection, and maintenance and the specific requirements in your company's license must be studied separately.

If you have already been instructed in your company's operating and emergency procedures, you will probably better understand the material presented in this manual. You will also get more out of the manual and the training course if you have worked as a radiographer's assistant using basic gamma radiography equipment, especially radiography cameras and survey meters, for at least a month. This introductory work experience will help you to understand and appreciate more fully the safety information presented to you.

*This manual is available for purchase through the NRC Government Printing Office Sales Program, USNRC, Washington, D.C. 20555. Telephone (301) 492-7333.

**Title 10, "Energy," Part 34, "Licenses for Radiography and Radiation Safety Requirements for Radiographic Operations," Section 34.31, "Training."

***NUREG/BR-0001, Vol. 1, "Case Histories of Radiography Events." Copies are available for purchase at current rates (bulk prices available) through the NRC GPO Sales Program.

Why Is Safety Training Important?

What Is Industrial Radiography?

The Beginning of Radiography

Radiation Hazards

Causes of Radiography Accidents



What Is Industrial Radiography?

Industrial radiography* is the process of using radiation to “see” inside manufactured products such as metal castings or welded pipelines to find out whether the products contain flaws. The process is the same one that a medical doctor uses to x-ray a patient’s chest or a dentist uses to x-ray a patient’s teeth.

In industrial radiography, radiation is produced either by x-ray machines or by radioactive materials contained in small capsules. The radiation penetrates the object being studied and exposes x-ray film placed behind the object. Holes, cracks, impurities, and other flaws



Figure 1. A dentist uses radiation in the same way as a radiographer. This radiograph shows an impacted wisdom tooth.

in the object allow more radiation to reach the film. A picture (or **radiograph**) of the object has darker areas on the film where more radiation has penetrated. A person looking at the film can tell from these darker areas if there are flaws in the object. These radiographs can detect flaws in the components of airplanes, submarines, pipelines, bridges, and power plants that could lead to dangerous accidents.

The Beginning of Radiography

The use of penetrating radiation in radiography is often thought of as a very modern development, but in fact using radiation in this manner is almost a century old. The origins



Figure 2. Wilhelm Roentgen won the Nobel Prize in Physics in 1901 for the discovery of x-rays.

of industrial radiography go back to December 1895, when the German scientist **Wilhelm Roentgen** discovered x-rays while experimenting with high-voltage electricity in vacuum tubes. The x-rays he produced

caused a fluorescent material to glow. Roentgen x-rayed a piece of metal to reveal variations in the metal. A year later, he made a radiograph of his shotgun that showed flaws in the barrels (Figure 3).

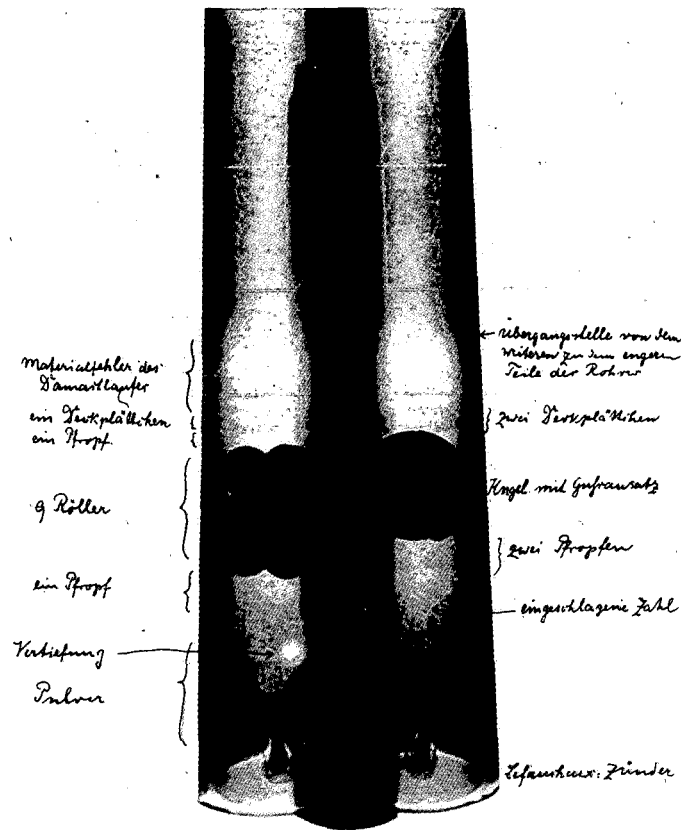

Figure 3. This radiograph of Roentgen’s shotgun is the earliest industrial radiograph (1896). This radiograph shows erosion in the barrels. Exposure time was 12 minutes.

*This manual contains a glossary defining terms commonly used in industrial radiography (Appendix E).

On New Year's Day, 1896, Roentgen mailed his report of the discovery of x-rays to the leading scientists of Europe, and into each envelope he slipped a handful of the pictures he had taken — the first x-ray pictures in the world. Within 2 months after Roentgen's announcement, hospitals throughout the world were using x-ray pictures to aid in surgery.

Discovery of Radium

The discovery of x-rays led scien-



Figure 4. Mrs. Roentgen's hand was x-rayed December 22, 1895. Roentgen mailed x-ray pictures such as this in 1896 to Europe's leading scientists to announce his discovery of x-rays.

tists to wonder whether any minerals within the earth would also emit similar penetrating radiation. In February 1896, a French scientist, **Henri Becquerel**, discovered such radiation coming from a uranium-bearing mineral.

Since Becquerel's rays were not intense enough to give pictures of bones, these rays were not nearly as fascinating as Roentgen's. The discovery was neglected for a year and a half. Then **Marie and Pierre**



Figure 5. Within 4 days after news of x-rays reached the United States, hospitals used them to aid in surgery. In February 1896, a man's hand was x-rayed in order to aid in the surgical removal of more than 40 gunshot pellets (black spots in the x-ray) embedded in the hand as a result of a hunting accident. Note the improvement in quality over Roentgen's original x-ray picture (Figure 4).

Curie, a wife and husband who worked together as scientists, discovered that uranium ore gave off much more radiation than expected. They suspected that another radiation emitter besides uranium was present.

In 1898, after very tedious chemical separations, the Curies managed to produce a tiny amount of a previously undiscovered element from tons of ore. They named the element **radium** for the great intensity of its radiation.

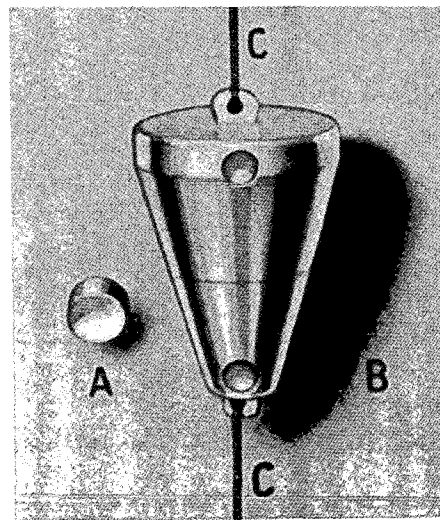

Figure 6. In 1940, radiography sources looked like this and usually contained about one-tenth of a curie of radium. The radium was sealed in a capsule (A) and placed in an aluminum-alloy container (B). This source was handled by using the cords (C) attached to the container.

At this point, the scientific basis for radiography using **gamma rays** existed. However, it would be 30 years before enough radium would be available for industrial radiography.

Early Gamma Radiography

Gamma radiography got its start in the United States in 1929 at the Naval Research Laboratory.^{1,2} The Navy wanted a method to test thick steel castings, but x-rays available at that time could not be used for thicknesses greater than 3 inches. Using radium, it was possible to radiograph castings up to 10 or 12 inches thick. The radium sources used then were very weak compared to modern sources. A source strength of one-tenth of a curie was typical, and exposure times of several hours to as long as 4 days were necessary.

Industrial radiography grew tremendously during World War II as part of the Navy's shipbuilding program. Manmade gamma ray sources such as cobalt and iridium became available in 1946, shortly after World War II. These new sources were far stronger than radium sources and were also much less expensive. The manmade sources rapidly replaced radium, and the use of gamma radiography grew quickly.

Radiation Hazards

Industrial radiography is a powerful tool, but it involves some significant risks.

Exposure to harmful radiation is an occupational hazard that you will face as a radiographer. Three characteristics of gamma radiography make serious accidents possible:

1. Gamma radiography sources emit intense and penetrating radiation so that they can be used for studying thick metal samples. This means that these sources can expose you to a great deal of radiation in a very short time.
2. The best radiographs are produced by sources with the smallest dimensions. The radiation intensity on the surface of small gamma ray sources is enormous. If you touch a source, it can cause serious harm.
3. Much radiography is done under difficult working conditions with little direct supervision or assistance. On heavy construction projects, movement of pipes and beams by heavy equipment presents a constant hazard and distraction. In addition, there is constant pressure to finish the radiography work as soon as possible. This pressure to rush can lead to accidents.

If you understand radiation hazards and practice proper procedures when working with radiation, you can work with radiography sources without ever being overexposed.

Gamma radiography sources are composed of radioactive material enclosed in small stainless steel

capsules. These sources emit intense radiation. If held in the hand, a typical source will cause radiation burns in seconds (Figure 9).

Very large doses of radiation to a small portion of the body may cause so much damage that amputation of the damaged tissue would be needed. The amputation of fin-

gers, legs, and portions of the torso and even death have been caused by radiography sources.

Most radiation overexposures caused by radiography accidents have not been large enough to cause radiation burns. However, even if the consequences of an overexposure are not seen immedi-

ately, long-term effects such as cancer may occur many years later. In fact, any amount of radiation you receive may increase your chances of developing cancer. For low doses of radiation, the risks are very small. We discuss the risks from exposure to radiation in Chapter 4.

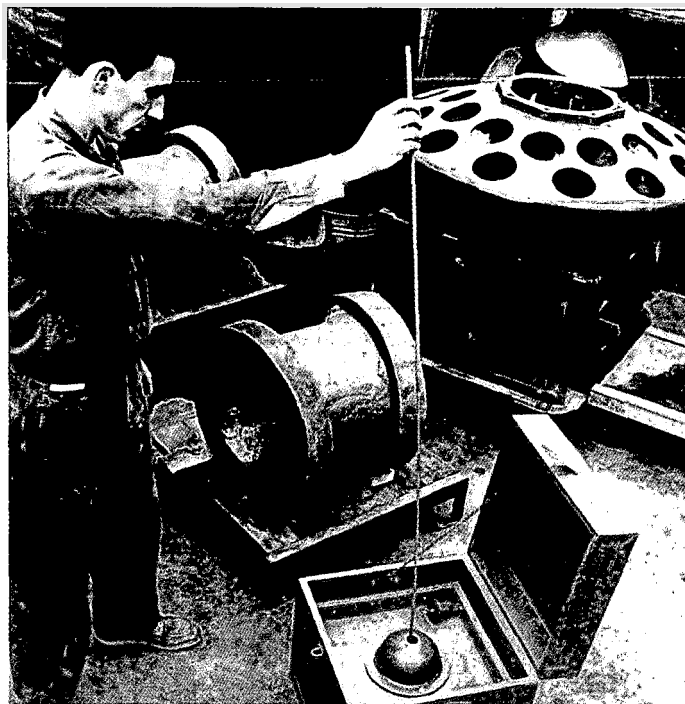

Figure 7. Early radium sources were handled using long "fishpoles" or cords. This method was suitable for weak sources. Better methods were needed to handle the stronger manmade sources that became available during the late 1940s.

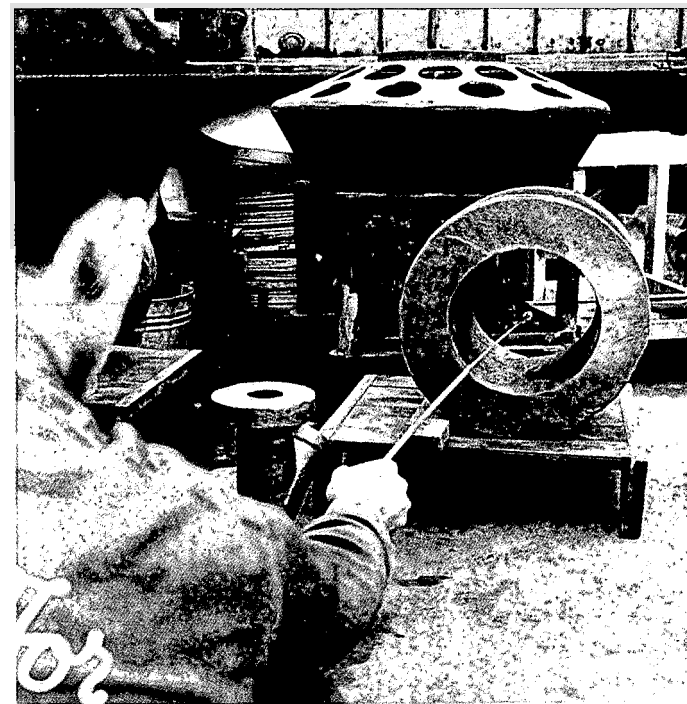

Figure 8. This picture of "fishpole" radiography was probably taken during the 1940s. The photo was obviously staged. The sources then available were so weak that exposures of an hour or more were necessary. Even the steadiest hand could not be still long enough to avoid a blurry radiograph.

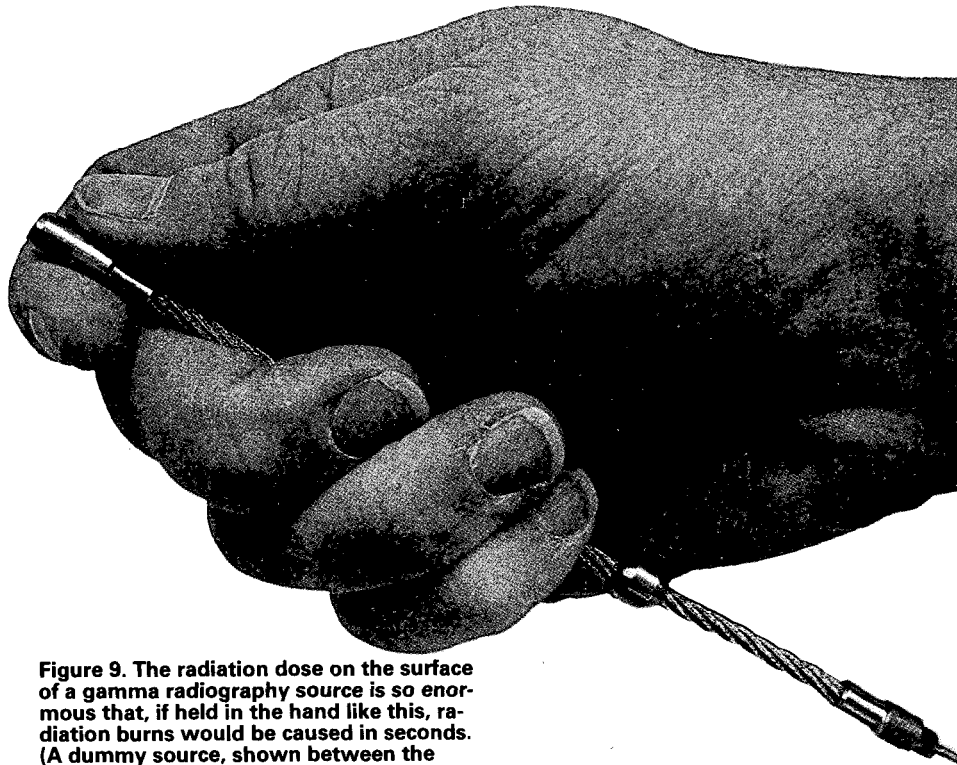

Figure 9. The radiation dose on the surface of a gamma radiography source is so enormous that, if held in the hand like this, radiation burns would be caused in seconds. (A dummy source, shown between the thumb and forefinger, was used in this photo.)

Causes of Radiography Accidents

Most radiography accidents happen when proper procedures for

working with radiation are not followed. Failure to follow proper procedures may be the result of rushing to complete a job, boredom, illness, personal problems, tiredness, lack of communication, poor training, or a number of other factors.

Radiography accidents usually happen after the radiographer has made three separate mistakes:

- The radiography source is left out of the camera when it should not be.

- A required radiation survey to ensure that the source has been retracted to its shielded container is omitted or is not done properly.
- The radiography source is not locked into place once it has been retracted into the safe, shielded position.

You can avoid these accidents by following your company's operating and emergency procedures. These procedures are written so that you can accomplish your job as a radiographer in a safe and efficient manner.

When you are working with a radiography source, you are responsible for your own safety and the safety of others in the area. The ability to make the right decisions and take the right actions comes from a combination of training and experience. Studying the following chapters will help you make sound decisions in your work.

It should be clear to you that industrial radiography has hazards associated with it. The rest of this manual discusses these hazards in more detail as well as important safety measures you should use to work safely in gamma radiography.



Figure 10. There are a number of reasons why a radiography source may be left exposed, but an exposed source does not necessarily have to result in an overexposure to radiation. Radiation surveys are performed to ensure that radiation levels are

safe. Radiation is not detected by the human senses. It is tasteless, odorless, noiseless, invisible, and it cannot be felt. But you can use a radiation survey meter to detect its presence.



2

What Is Radiation?

A Form of Energy

Radiation Dose

How Much Radiation Are People Exposed To?



Radiation — is it deadly or is it beneficial for the world? The word *radiation* causes all sorts of reactions these days. What are we to make of it?

On one hand, we hear that nuclear power is going to save an energy-starved world. Some say the power of the atom will give an ocean of energy that can help produce our food, fuel our industries, recycle our precious minerals, and restore our standard of living.

But we also hear about the “radiation nightmare” and the destructiveness of radiation. This nightmare is symbolized by mushroom clouds and giant chimneys looming over nuclear power plants. There is also the scare of Geiger counters clicking rapidly, people dying of cancer, and the horror of giving birth to mutated children — all because of an invisible danger. But most people do not understand radiation and, therefore, it may appear to them to have magical powers.

Which image of radiation is closer to the truth? Before we try to clear away the fog of confusion, let's first try to understand what radiation is.

A Form of Energy

Radiation is a form of energy. There are two basic kinds of radiation. One kind is tiny fast-moving particles that have both energy and weight. We refer to these as **particle radiation**. These particles of radiation are similar to speeding bullets, but the particles are much smaller — so small that you cannot see them. Speeding **electrons** are radiation particles of this kind.

The other kind of radiation is pure energy with no weight. **Gamma rays** are an example. This kind of radiation is like vibrating or pulsat-

ing waves of electrical and magnetic energy. The radiation waves are called **electromagnetic waves** or **electromagnetic radiation**. We refer to these as **wavelike radiation**. Ordinary visible light is another form of wavelike radiation. Light travels so fast that our senses tell us it travels from one place to another instantly. All wavelike radiation travels just as fast. It travels at the speed of light.

Energy must be used to produce light. In an electric light bulb, electrical energy is converted into heat (thermal energy). The filament of the bulb becomes white-hot and

emits light. If we were to look at the individual atoms of a white-hot object, we would see that the atoms shake very fast. Heat is the measure of how fast the individual atoms in a substance are moving. But it is a law of nature that when atoms are moving very fast, they will give off some of their energy in the form of wavelike radiation if anything changes their motion.

The most energetic light that our eyes can detect has a violet color. As the energy of the radiation particles increases, we say that the light has gone beyond violet — it has become ultraviolet. We cannot see it

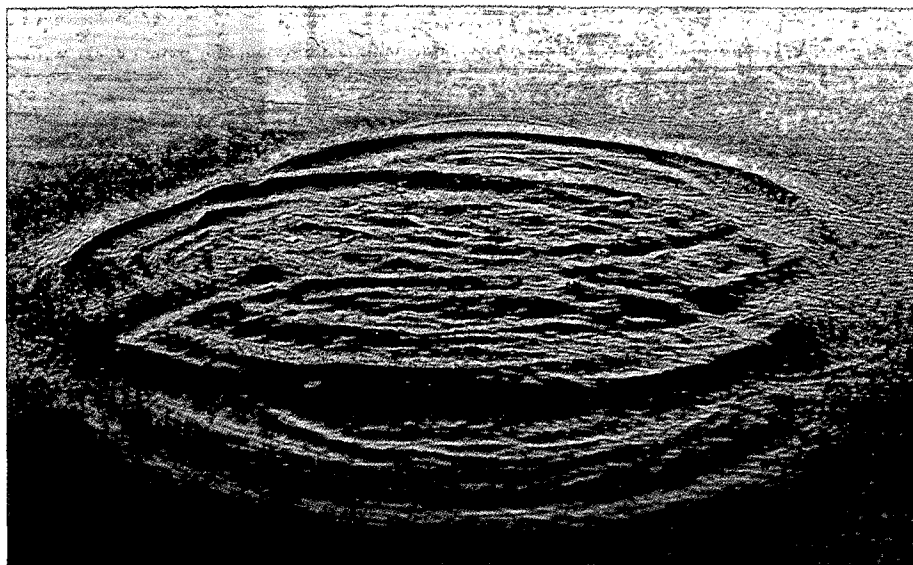

Figure 1. Wavelike radiation is similar to the waves made by a stone dropped in a quiet pond. The waves carry energy away from a disturbed point at the center. Visible light, radio waves, microwaves, x-rays, and

gamma rays are all wavelike radiation. The waves have both an electrical part and a magnetic part. So wavelike radiation is called *electromagnetic radiation*.

What is an atom?

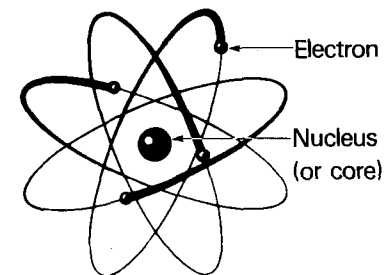

Figure 2. *Atoms* are small building blocks that make up everything we can touch. Each atom is composed of a heavy core or nucleus at the center and a cloud of electrons orbiting around the nucleus. The picture above shows an artist's view of an atom. What we know as electricity in our everyday life is nothing more than the movement of large numbers of electrons that have broken free of the atoms of which they were a part.

or feel it, but it is still there and can give us a suntan or a sunburn if the intensity is too great.

X-Ray Radiation

To produce even more energetic radiation, electrons are made to travel at enormous speeds, smash into other electrons, and thereby give off very energetic wavelike radiation. We call this type of radiation **x-rays**. X-rays have much more energy than visible light.

To produce these x-rays, we use an electric spark. A spark is a stream of electrons. Very high electric voltages are used in a vacuum to produce such sparks. These high voltages cause the electrons in the spark to travel enormously fast. The electrons strike other electrons in a target material with incredible impact. The collisions are so violent that powerful waves of radiation are emitted in all directions. The radiation is x-rays.



Figure 3. As the voltage increases, the x-rays become more energetic and more penetrating. A voltage of 10,000 volts was used to produce this x-ray of tulips. Much higher voltages are needed to penetrate heavy metal objects.

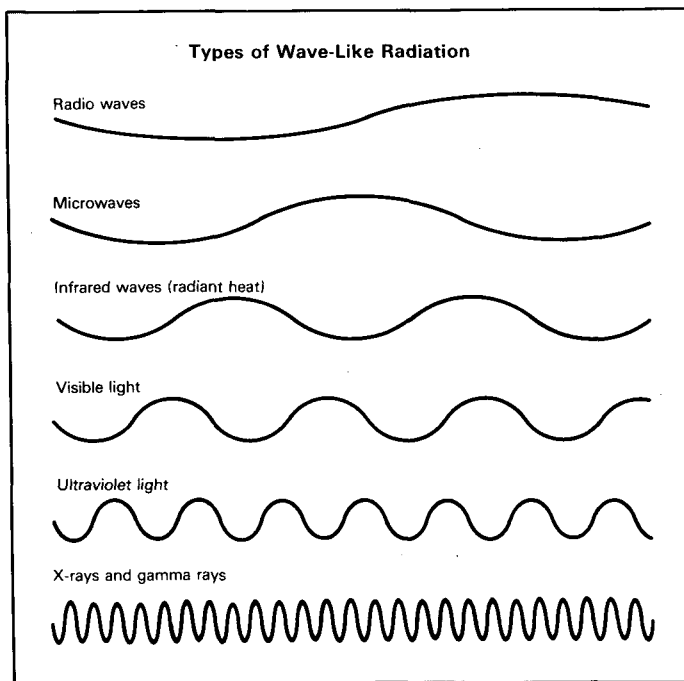

Figure 4. These types of wavelike radiation are similar. The waves that vibrate the fastest have the most energy. Why are microwaves dangerous if their particles have even less energy than visible light? Microwaves can be dangerous if they are extremely intense. Microwave ovens and microwave communication transmitters produce microwaves in great intensities. Each microwave that is absorbed in your body heats your body slightly. The combined heating effect of enough microwaves would be fatal. Fortunately, microwave ovens can be built to prevent most microwaves from getting out so there is almost no heating of objects outside the oven.

Gamma Ray Radiation

A **gamma ray** is the same as an x-ray except that it comes from a different source. X-rays are caused by speeding electrons striking other electrons in a target. Gamma rays come from the **nucleus** or core of certain atoms that have too much energy. Some atoms have so much extra energy inside that the nucleus is constantly undergoing a violent

shaking. Sooner or later something snaps. The nucleus can give up its extra energy by throwing off a tiny particle of an atom and a gamma ray. The gamma ray is a weightless kind of radiation similar to light, but with much more energy. The tiny particle of the atom that is thrown off is also radiation, but it has weight as well as energy.

Figure 5. This historical photograph, published in 1923, shows the tracks made by electrons that have been hit by a narrow beam of x-rays. The x-rays pass through very moist air striking electrons in their path. These electrons speed off leaving a trail of electrically charged particles. Each

particle becomes a center for the condensation of a visible droplet of water. The water droplets that are formed are photographed. C. T. R. Wilson, the scientist who took this photograph, won the Nobel Prize in physics for this work.

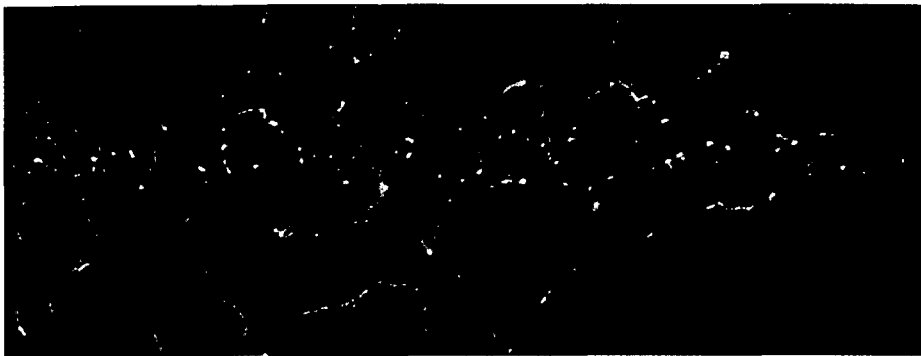

Collisions

When radiation as powerful as x-rays or gamma rays strikes some physical object, some of the radiation interacts with the object.

The radiation waves miss most of the electrons in the object. A wave interacts only if there is a perfect bull's eye on an electron. This enables an x-ray or gamma ray to penetrate quite deeply into material before it hits an electron perfectly on target.

If the radiation wave hits an electron, a powerful collision occurs. The collision is so powerful that the electron is ripped free of the atom to which it was attached. The freed electron speeds off through the target substance. The speeding electron is a particle of radiation that has weight as well as energy.

This electron has been given so much energy that the electron itself now strikes other electrons and causes them to break free from the atoms to which they were attached. The photograph shown in Figure 5 illustrates what happens when a narrow beam of x-rays or gamma rays passes through air.

The violent ripping away of an atom's electrons is quite different from what happens when visible light strikes a substance. Light causes the electrons to become a little excited, but doesn't usually create freed electrons and incomplete atoms.

However, x-rays and gamma rays disturb the atomic structure so much that atoms may enter into chemical reactions with each other.

These chemical reactions happen in a radiographer's film when an x-ray or gamma ray interacts with an atom in the film. These chemical reactions also can cause biological damage in the radiographer's body. Damage can happen if the radiation's energy breaks apart molecules in the cells of the human body. We'll discuss the harmful effects of radiation in Chapter 4.

X-rays and gamma rays cause almost no damage in metals, however. Metals conduct electricity easily. If an atom loses an electron, other electrons are free to move in the metal to quickly restore the

electrical balance. No chemical reaction occurs to damage the material.

Ionization

Ripping the electron off an atom is called **ionization**. Ionization means that two **ions** (or electrically charged particles) have been created. The electron has a **negative electrical charge**. The atom that remains behind has a **positive electrical charge**. A radiation survey meter responds to charged particles or ions that are created inside its detector.

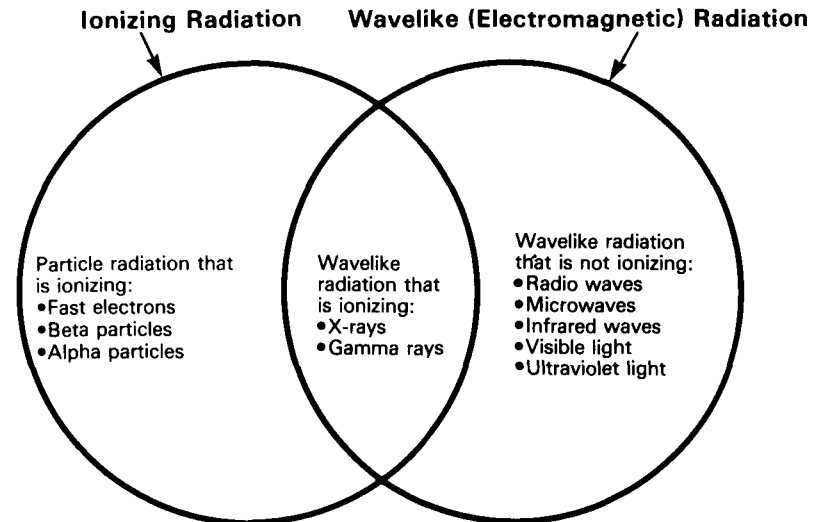

Figure 6. When most people talk about radiation, they are talking about **ionizing radiation**, shown in the left circle. Ionizing radiation can be either fast-moving particles (like fast electrons and beta particles) or waves of pure energy (such as gamma

rays and x-rays). **Wavelike radiation** is shown in the right circle. Some wavelike radiation such as visible light does not have enough energy to produce ions. Other wavelike radiation such as gamma rays and x-rays has enough energy to create ions.

So far we have talked about ionization caused by wavelike radiation such as x-rays and gamma rays. But ionization can be caused by particles of radiation, too. When an x-ray or gamma ray strikes an electron it gives energy to the electron. That electron is now an energetic particle of radiation. The electron causes additional ionization along its path because it hits other electrons like one billiard ball hitting another. Figure 5 shows the paths that the fast electrons followed.

The different types of radiation, waves or particles and **ionizing** or **non-ionizing**, are shown in Figure 6. In the remainder of this manual, when we say "radiation" we will mean **ionizing radiation**. The term radiation will include gamma rays and x-rays, but not visible light or microwaves.

Radiation Dose

It is possible to collect the charged particles left by gamma rays or x-rays if the charged particles are free to move. The charged particles can move in a gas. If a gas is located between two metal plates, each with an electrical charge (one positive and one negative), it is possible to collect the electrons and the positively charged atoms. Figure 7 shows how the charged particles are collected. The charged particles move to the metal plates because opposite electrical charges attract.

Electrical current is the motion of charged particles such as electrons. If we measure the electrical current flowing in the wire, we can determine how many charged particles are moving in the gas. This is the basic principle of the operation of a radiation survey meter.

cause in air. The amount of ionization in air caused by x-rays or gamma rays is called the **exposure**.* Exposure is expressed in terms of a scientific unit called a **roentgen**. This unit is named after the German scientist Wilhelm Roentgen, the discoverer of x-rays.

dials of radiation survey meters. Radiation survey meters measure *roentgens*.

Rems

It is possible to relate the amount of ionization that a beam of x-rays or gamma rays causes in air to the amount of biological damage that would be caused in living tissue placed in the beam. The measure of this biological effect of radiation is the radiation **dose**. Dose is measured in units of **rems**. (The word *rem* is an abbreviation for "Roentgen Equivalent in Man.")

For the types of radiation used by radiographers, x-rays and gamma rays, 1 rem is equal to about 1 roentgen. Therefore, these units are often used interchangeably in industrial radiography. You often may see the dose given in **millirems** (abbreviated **mrem**). One thousand millirems make 1 rem.

We will usually use roentgens or "R" when we refer to the reading of an instrument such as a survey meter or a pocket dosimeter. These instruments measure ionization and roentgen is the unit of ionization. We will use rems as the unit of dose where biological effect from radiation exposure is being considered. Therefore, biological effects, dose limits, and records of doses received by radiographers will be given in rems. But in gamma or

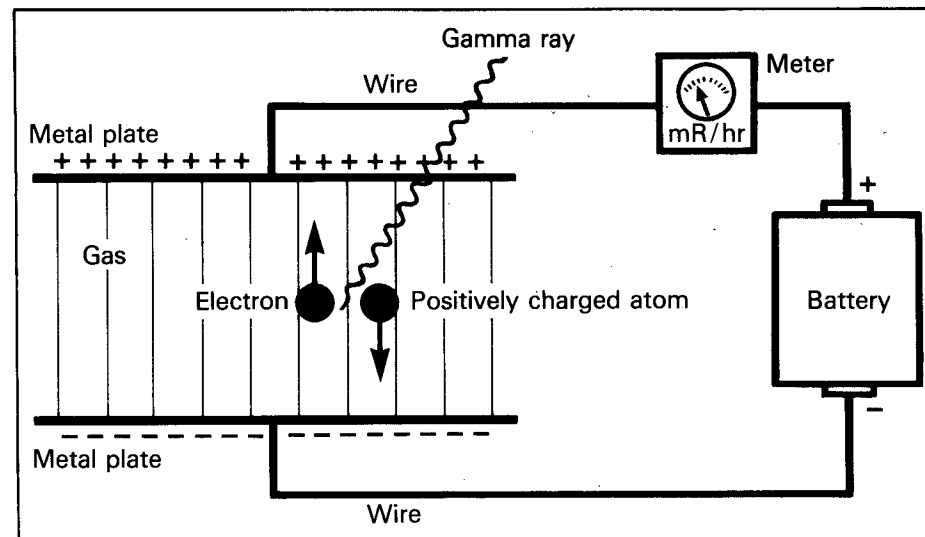

Figure 7. Charged particles are created in a gas by radiation. The charged particles are collected on metal plates if a voltage is applied to the plates. The area between the plates is the detector. The collection of the charges on the metal plates causes an electrical current to flow in the wire. A meter placed on the wire can measure the current. The more radiation, the greater the electrical current.

The abbreviation for the roentgen is "R" or "r." You have probably seen these abbreviations on the

* *Exposure* really has two different definitions. One definition is the technical definition stated above: a measure of the ionization in air caused by gamma or x-rays. However, exposure also has a common meaning: being subjected or exposed to some hazardous substance. For example, we can say, "Exposure to chlorine gas is dangerous." Or "He was exposed to radiation." In this manual, we will use this non-technical meaning for exposure.

Roentgens

The intensity of x-rays or gamma rays can be measured by measuring the amount of ionization they

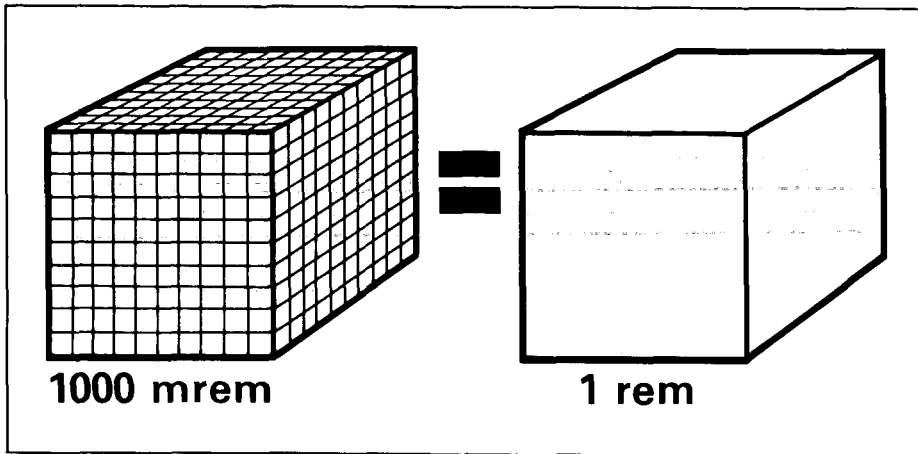

Figure 8. The cube on the left contains 1000 small cubes (10 x 10 x 10). The illustration shows it takes 1000 millirems to make up 1 rem. This means that a millirem is one-thousandth of a rem. To convert rems into millirems, you multiply by 1000. To convert millirems into rems, you divide by 1000.

x-ray radiography, one rem is about equal to one roentgen, so we can easily convert from one to the other. For example, if your dosimeter reads 0.1 roentgen for a month, your dose for the month is 0.1 rem.

Dose Rates

It is often important to know *how rapidly* radiation dose is being received. For example, you may want to know, "What dose will I receive if I stand here for 1 hour?" The measure of how fast radiation dose is being received is called the **dose rate**. So it is common to see dose rates such as roentgens/hour, rems/hour, and millirems/hour. If, in a certain place, the radiation level is given as 1 roentgen/hour, this means that a person standing

in that place for 1 hour will receive a dose of 1 roentgen or 1 rem. The relationship is:

$$\text{Dose} = \text{Dose rate} \times \text{Time}$$

This idea might be more understandable if you think of the odometer and the speedometer of an automobile. The number of miles on the odometer corresponds to radiation *dose* in rems. The speed on the speedometer in miles/hour is the rate at which miles are accumulated, corresponding to *dose rate* in rems/hour.

For gamma radiation, you may see dose rates in terms of R/hour; that is, roentgens/hour or rems/hour. You may also see mR/hour. Another possibility is mR/min, or mR/minute: to convert mR/min to mR/hour, you multiply by 60 because there are 60 minutes in an

hour. To be able to convert dose rates from one unit to another is important.

Problem:

You are standing in an area where your survey meter reads 0.2 R/hr. How long will it take before you receive a dose of 100 mrem?

Solution:

$$0.2 \text{ R/hr} = 200 \text{ mR/hr}$$

$$200 \text{ mR/hr} = 200 \text{ mrem/hr}$$

$$\text{Dose} = \text{Dose rate} \times \text{time}$$

$$100 \text{ mrem} = 200 \text{ mrem/hr} \times \text{time}$$

$$\text{Therefore, time} = \frac{100 \text{ mrem}}{200 \text{ mrem/hr}} = \frac{1}{2} \text{ hr}$$

$$\frac{1}{2} \text{ hr} \times \frac{60 \text{ min}}{1 \text{ hr}} = 30 \text{ min}$$

How Much Radiation Are People Exposed To?

Now that we have given you "rem" as a word to measure the quantity of radiation dose, let's see how many "rems" different people are exposed to.

Natural Sources of Radiation

Is it true that radiation is basically "manmade" and "artificial?"

No, not at all. Humans have always been exposed to radiation from naturally occurring sources.

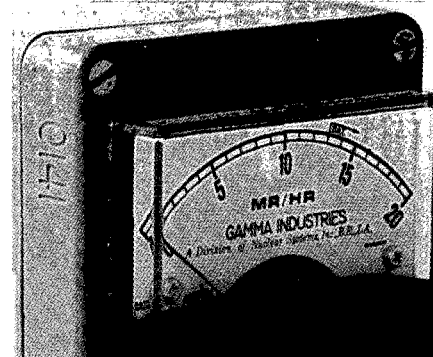

Figure 9. Radiation survey meters show a *rate*. Usually the meter will show milliroentgens per hour, which is abbreviated mR/hr.

Is it true that everybody is constantly exposed to naturally occurring radiation from sources in the environment?





Yes. Everybody in the world receives a small amount of radiation at all times from natural radiation sources. This is called **natural background radiation**.

Radiation is given off constantly by naturally occurring radioactive materials all around us — in the ground, in the walls of buildings, and even in our bodies. These radioactive materials have been present on earth since it was formed. In addition, the earth is bombarded by radiation from the sun and from other sources in outer space. This radiation is known as **cosmic radiation**. Roughly equal amounts of radiation come from cosmic radiation from outer space, naturally occurring radioactive materials in the human body, and naturally occurring radioactive materials found in the earth. Some radiation also comes from naturally occurring radioactive materials in bricks and concrete used in buildings.

The exact amount of radiation that a person receives from natural sources depends on where the person lives. People living at high altitudes receive more cosmic radiation than people living near sea level because there is less air

above them to shield them from the radiation from outer space. Also, some ground areas contain higher concentrations of radioactive materials than others. For example, in Denver, which has a high altitude and an abundance of radioactive materials in the ground, background radiation levels are about 50% higher than the U.S. average.

Figure 10 shows the average yearly radiation dose to individuals in the U.S. from naturally occurring radiation. The doses apply to most body organs, although some organs such as the lung have somewhat higher doses. As you can see, the average yearly dose is 83 mrem.^{1,2} If you would like a *rough estimate* of natural radiation dose that is easy to remember, a dose of 100 mrem/year is an easy number to remember and is a roughly accurate figure.

Source	Annual Dose (mrem/year)
 Cosmic rays (Radiation from the sun and outer space)	28
 Building materials	4
 Human body	25
 The earth	26
Total	Roughly 100 mrem/year

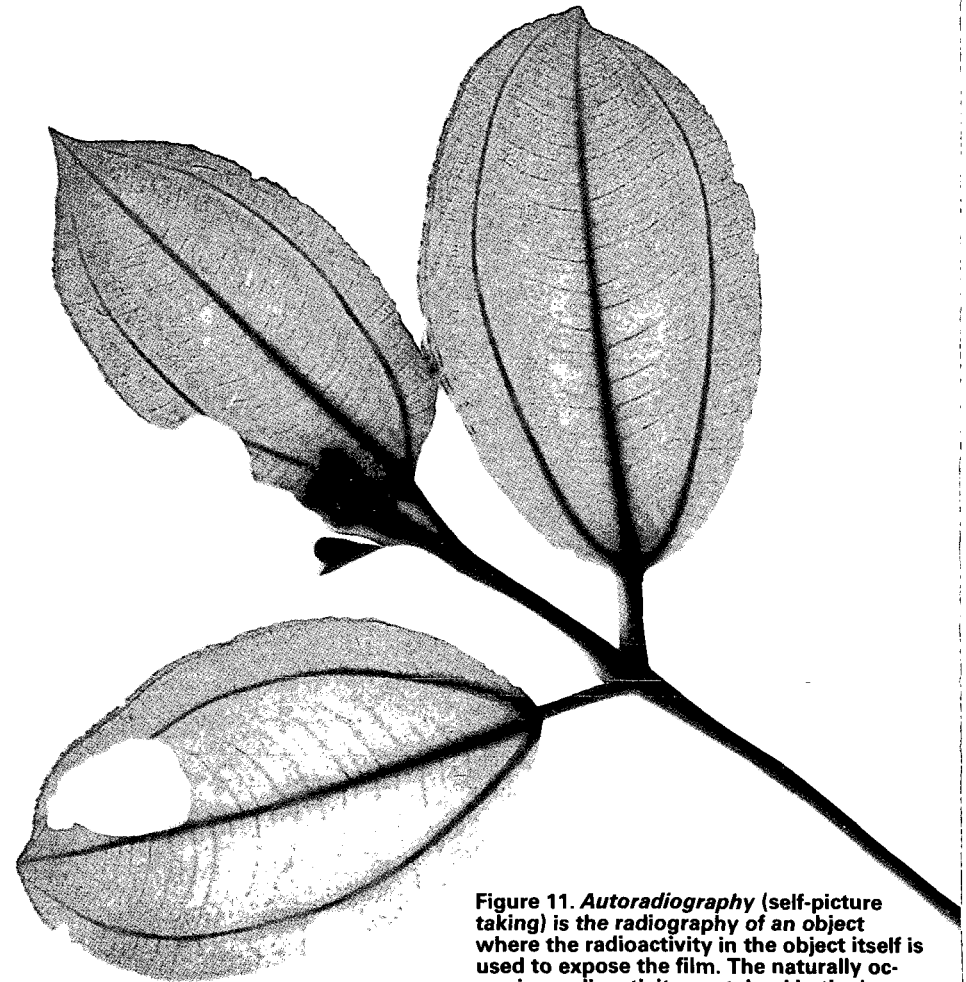

Figure 11. **Autoradiography** (self-picture taking) is the radiography of an object where the radioactivity in the object itself is used to expose the film. The naturally occurring radioactivity contained in the leaves of these plants was used to make these autoradiographs.

In some parts of the world, such as certain small regions of India and Brazil, there are much higher levels of radiation.³ Radiation from thorium-bearing sands in these areas causes some people who live in these areas to receive natural radiation doses of 1000 to 3000 mrem per year.

Figure 10. Average annual doses from natural background radiation in the United States.

Radiation from Manmade Sources

People are also exposed to manmade sources of radiation. The following are examples of **manmade radiation**: medical and dental x-rays, the use of radioactive materials injected into the body for med-

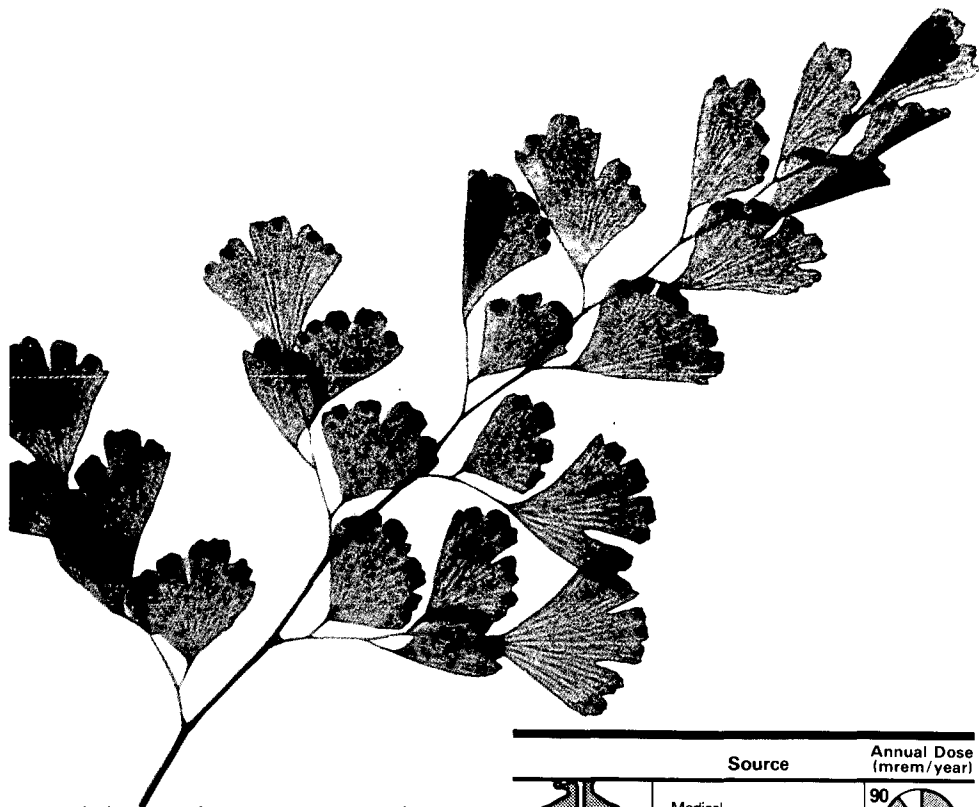









ical diagnosis or treatment, fallout from nuclear weapons tests, radiation from consumer products (such as color television sets, smoke detectors, radium or tritium in luminous dial wrist watches and clocks, uranium contained in false teeth), radiation released by nuclear power plants, and occupational exposure of workers who work with radiation on their jobs.

As you can see from Figure 12, people get most of their exposure to manmade radiation from medical

and dental x-rays. The average annual dose to a person in the United States from medical and dental use of radiation is 90 mrem.^{4,5} All other manmade sources of radiation combined add about 6 mrem to the average person's dose.⁵⁻⁷

To make a simple approximation of manmade radiation dose to an average person in the U.S., we can say, "The average person receives a radiation dose of about 100 mrem per year from manmade sources, most of which comes from medical x-rays."

So, in round numbers, the average person in the U.S. receives an annual radiation dose of about 200 mrem per year, half from natural background radiation and half from manmade sources. Let's compare this radiation dose to typical occupational radiation doses.

Source	Annual Dose (mrem/year)
 Medical (primarily from diagnostic x-rays)	90 
 Fallout from atomic bombs	5 
 Nuclear Power	0.3 
 Consumer Products (mostly from color TV sets)	1 
Total	Roughly 100 mrem/year

Occupational Radiation Doses

Radiation is used in various occupations. Examples are medicine, industrial radiography, and the operation and maintenance of nuclear power plants.

There are close to 1.5 million workers in the United States who work with or near radiation sources in some way, although most of these

workers have little contact with the radiation sources and receive little or no measurable radiation dose.

The amount of radiation that you are permitted to receive by law will be discussed in Chapter 8 on regulations. But to simplify the legal dose limits, we can say that basically the dose limit for workers is 5 rems per year.

By comparison, some average radiation doses for certain workers who received a measured dose are shown in Figure 13.⁸

The average occupational dose to workers at gamma radiography companies is about 440 mrem/year.* To this we must add 200 mrem/year to account for natural background radiation and radiation from other manmade sources.⁹ The total is roughly 600 mrem/year, about 3 times the average dose for the whole U.S., but slightly less than the average dose for workers with measurable radiation doses at nuclear power plants. An airline pilot who flew 3,000 miles per day would receive a radiation dose from cosmic rays equal to the average dose to a worker at a radiography company.

*The average dose includes the dose of everyone who wore a dosimeter to measure radiation dose and for whom some dose was measured.

Figure 12. Average annual radiation doses from manmade sources in the United States.

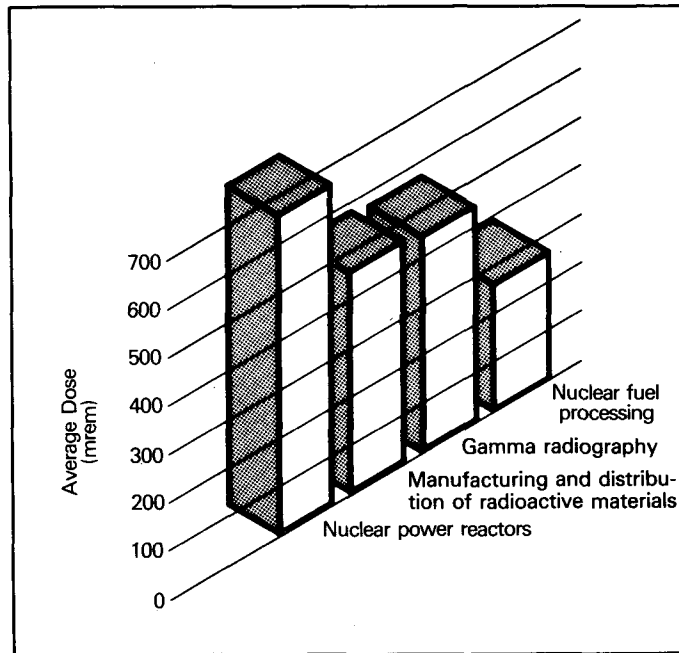

Figure 13. Average doses of workers with measurable doses at some NRC-licensed facilities in 1978.

The average occupational dose of 440 mrem/year at radiography companies, however, includes radiographers who perform other types of nondestructive testing and spend very little time doing radiography. The average dose also includes many people who work for companies holding a radiography license and who wear film badges but seldom or never work with radiation sources.¹⁰

The average dose received by a gamma radiographer who works actively is probably closer to 1,300 mrem,⁸ and annual doses of 5000 mrem occur sometimes. Probably about 3000 to 4000 radiographers in the country receive doses exceeding 1 rem (1,000 mrem) per

year.¹¹ This number is out of perhaps (very roughly) 10,000 people who spend at least a week per year actually performing radiography using radioactive materials.¹² In Chapter 4 on the effects of radiation, we will assume that the average annual radiation dose received by a radiographer is 1 rem. This is a rough estimate, but it is adequate for our purposes.

The dose that an industrial radiographer can expect to receive in a lifetime of work in industrial radiography is probably in the vicinity of 20 rems according to information from the NRC, based on termination reports filed by licensees.¹³ We will use this 20-rem estimate of lifetime dose in Chapter 4 where we will discuss the risk industrial radiographers face from exposure to radiation.

Questions

1. What is *radiation*?
2. A radiation survey meter reads 10 mR/hr. How long will it take before a dose of 2 mrem is delivered?
3. The radiation dose rate at a certain distance from a radioactive source is 2 R/hr. How long will it take before a dose of 100 mrem is delivered?
4. Describe where naturally occurring background radiation comes from.
5. What are some factors that will affect the amount of natural background radiation you will receive?
6. What is the largest source of manmade radiation that an average person is exposed to?
7. Roughly how much radiation dose does an average person receive each year from natural background radiation?
8. Roughly how much radiation dose does an average person receive from manmade sources of radiation each year?
9. Roughly how much radiation dose does a person working actively in gamma radiography receive at work each year?
10. How much dose did your radiation badge read last month? At that rate, how much dose would you get in a year?

3

What is Radioactivity?

Radioactive Decay

Half-Life

Using Graphs

Can Radiography Sources Make Things Radioactive?



Radioactivity

Radioactivity is the emission of radiation from an unstable atom. Most atoms are stable and will never emit any radiation. But certain kinds of atoms have a large surplus of energy. These atoms are called unstable atoms. Eventually these atoms will emit radiation — a highly concentrated form of energy. The radiation will carry off the surplus energy from the atom. The radiation can be in the form of particles that have weight such as electrons or in the form of weightless waves of pure energy such as gamma rays.

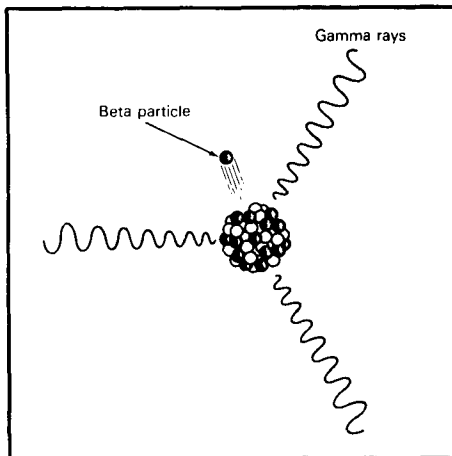

Figure 1. Radioactive decay. An artist's concept of an unstable atom emitting radiation. The wavy lines represent gamma rays. The black ball speeding away from the atom is a beta particle. A beta particle is a fast-moving electron emitted from an atom during radioactive decay.

If a material is radioactive, its atoms emit radiation when they break up. The gamma rays used in radiography come from radioactive atoms. The atoms emit **gamma rays**. The atoms also emit particles called **beta particles**. Beta particles are fast-moving electrons. However, the beta particles cannot penetrate the steel capsule that contains the radioactive material. Therefore, the beta particles don't get out of the capsule.

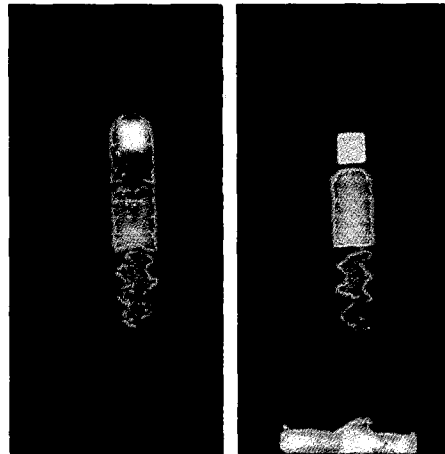

Figure 2. A radiograph of two radiography sources shows the radioactive material inside the steel capsules. The white squares are iridium-192. The capsules are attached to steel cables.

Most chemical elements have both stable and unstable forms. The different forms of an element are called **isotopes**. A *stable* isotope does not emit radiation. An *unstable* isotope does. These unstable isotopes are called **radioactive isotopes** or **radioisotopes**. These terms refer to forms of the element that emit radiation. The radioactive isotopes used most often in gamma radiography are **iridium-192** and **cobalt-60**.

X-Ray Machines

An x-ray machine is not **radioactive**. Its radiation does not come from unstable atoms. The machine emits radiation, but the radiation comes from collisions between speeding electrons and atoms. An electrical voltage causes electrons to jump across a gap and strike atoms in a target. The atoms absorb energy from the electrons and emit their surplus energy in the form of x-rays.

When the electrical voltage in an x-ray machine is turned off, no more electrons jump across the gap and no more radiation is emitted. But radioactive atoms cannot be turned off. Nothing we can do can stop the individual atoms in a radioactive material from breaking up. The unstable atoms will break up at their own pace, and there is nothing we can do to change that pace. The special requirements to store radiography sources securely are very important because no one can "turn off" radioactive atoms.

Radioactive Decay

The **disintegration** or breaking up of an unstable atom with the emission of radiation is called **radioactive decay**. Most types of unstable atoms, including those most commonly used in radiography sources, emit radiation or decay only once. Once one of these atoms has given up its excess energy, it becomes a stable atom and is no longer radioactive. This is why radiography sources become weaker and weaker. The number of unstable atoms keeps getting smaller and smaller. Less and less radiation is emitted. Eventually there will be none left and the material will no longer be radioactive.

The loss of all radioactivity can take a very long time. Even radiography sources that have become too weak to be useful in radiography are still dangerous for many years. These old sources must be handled carefully. They can be disposed of only as **radioactive waste**, which must be sent to special sites permitted to receive radioactive waste. Old radiography sources are usually returned to the supplier of the sources. Radiography sources cannot be treated as ordinary trash and thrown in the garbage.

The strength of a source is called the **activity**. Activity is defined as the number of radioactive atoms that will decay and emit radiation in 1 second of time. The **curie** (abbreviated **Ci**) is the unit used to measure activity.*

You might use an iridium source with a strength of 100 curies. A 100-curie iridium source will emit the same amount of radiation as two 50-curie iridium sources or ten 10-curie sources. (When we say an "iridium source," we mean "iridium-192." When we say a "cobalt source," we mean "cobalt-60.")

A 1-curie iridium source does *not* give the same radiation dose as a 1-curie cobalt source. The iridium source and the cobalt source both have exactly the same number of disintegrations per second, and a disintegration of each produces about 2 gamma rays.¹ The average energy of a gamma ray from cobalt is about twice as great as the average energy of gamma rays from iridium. Because of this, the dose rate around the cobalt source will be greater than the dose around the iridium source.

The greater energy of the cobalt gamma rays means that its rays will be more penetrating. Cobalt requires more shielding and can be used to radiograph thicker sections of metal than iridium.

Half-Life

One of the unique characteristics of each kind of radioactive isotope such as iridium-192 or cobalt-60 is the time required for one-half of the initial number of unstable atoms to decay. *The time required for one-half of the unstable atoms to decay is known as the **half-life** and is given the scientific symbol " $T_{1/2}$."* The half-life of a radioactive isotope cannot be changed.

If the number of radioactive atoms in a source is reduced by half, the amount of radiation emitted by the source will also be reduced by half. After one half-life, the activity of a radioactive source will be one-half its initial activity. After two half-lives, the activity will be reduced to $\frac{1}{4}$ of its original activity ($\frac{1}{2} \times \frac{1}{2} = \frac{1}{4}$). Similarly, after three half-lives, only $\frac{1}{8}$ of the original activity will be left ($\frac{1}{2} \times \frac{1}{2} \times \frac{1}{2} = \frac{1}{8}$), and so on. After ten half-lives, less than one-thousandth of the original activity will remain.

The illustration in Figure 3 shows how fast a 100-curie iridium-192 source decays away. Iridium has a half-life of almost 75 days (or about $2\frac{1}{2}$ months). At the end of 75 days, half of the original 100 curies of iridium has decayed away, leaving 50 curies. At the end of a second 75 days, an additional 25 curies has decayed away.

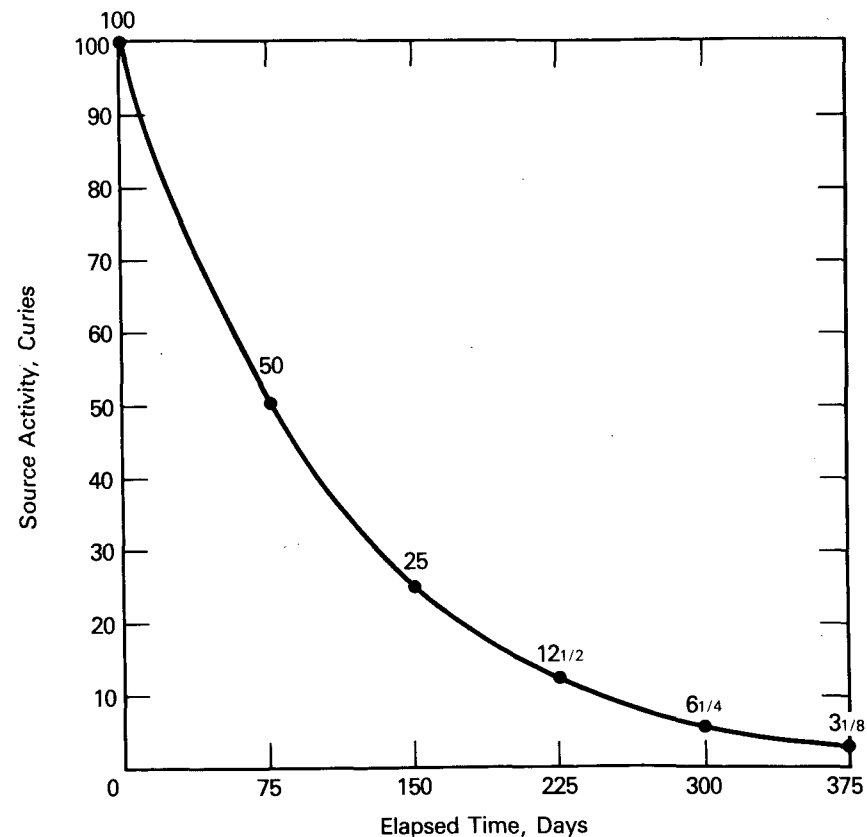

Figure 3. The decay of iridium-192. It takes 75 days for half of the iridium-192 to decay away. After 75 days an iridium-192 source has lost half of its radioactivity.

Cobalt-60 has a half-life of just over 5 years. If we start with 100 curies, in 5 years we will have about 50 curies. How much will we have in 10 years? In 20 years?

In 10 years, 25 curies of cobalt-60 will remain. Twenty years is equal to 4 half-lives. Therefore, the activity will be $100 \text{ curies} \times \frac{1}{2} \times \frac{1}{2} \times \frac{1}{2} \times \frac{1}{2}$.

This equals $\frac{100 \text{ curies}}{16}$
or $6\frac{1}{4}$ curies.

*The unit is named after Marie and Pierre Curie, the scientists who discovered radium.

Having some idea of the rate of decay of these radioactive materials can be useful. If you go to a storage vault to check out an iridium source that you last used 2 or 3 months ago and the radiation dose rate on the container surface is about half of what it was before, everything is about right. The iridium source should be only about half as strong after 2 or 3 months.

But if the surface radiation dose rate on a cobalt-60 container reads only half of the value it had 2 or 3 months ago, something is wrong.

Most probably your radiation survey meter is not working quite right. You will have to check to see if it is operating properly. Or else the cobalt source might have moved in its shield. Check to see that the container is properly locked. You will have to figure out what is going on.

Using Graphs

The method just described can be used to make a rough approximation of how much activity a source will lose over some time interval. Sometimes such a rough approximation will be useful to you. However, to determine the proper exposure times for film, it is necessary to have a much more precise estimate of the activity of the radioactive source.

To provide an accurate value for source activity, the manufacturer of every radiography source provides a graph with the source. The graph gives the activity of the source in curies at different dates.

To learn how to read these graphs, a simplified graph is first shown here (Figure 4). To determine the activity of a source in curies on some date, you first locate that date at the bottom of the graph. Let's take the date of June 1, 1982, for example. Locate that date at the bottom of the graph.

Now follow the vertical line up from that date to the diagonal line — the line marked "source activity." Note where the vertical line from the date crosses the diagonal line.

From that point, move horizontally to the left. Note where this horizontal line crosses the left-hand scale of the graph. Read the source activity in curies from the scale on the left-hand side. What activity do you read for June 1, 1982? The answer is 3.5 curies.

Look carefully at the left-hand scale. Note the distance between

100 curies and 90 curies, a difference of 10 curies. The distance is small. It takes only a little more than a week to lose this 10 curies. Now note the distance between 20 curies and 10 curies, also a difference of 10 curies. Are they the same distance apart on the graph? No. The distance is much greater. It takes 75 days for a 20-curie source to lose 10 curies.

Why are the distances different? The reason is that a larger source loses curies faster than a smaller source. For example, in one half-life of 75 days, a 100-curie iridium

Figure 4. The decay of iridium-192.

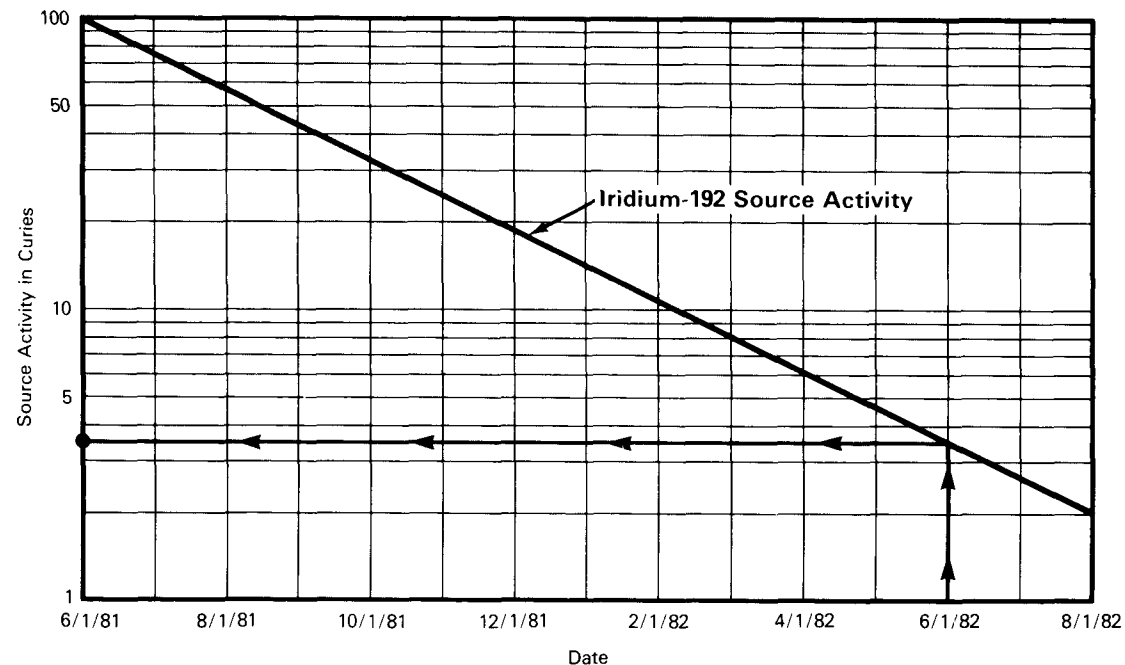

source loses 50 curies. But a 20-curie source loses only 10 curies in one half-life.

The 100-curie iridium source loses 50 curies of activity in its first $2\frac{1}{2}$ months. In its second $2\frac{1}{2}$ months, it loses only 25 curies. This was shown in Figure 3. The line showing source activity is a curved line. We got a straight line in Figure 4 by making the distance from 100 curies to 50 curies the same as the distance from 50 curies to 25 curies by using a different type of scale.

Logarithmic Scales

To show source activity by using a straight line, it is necessary to expand the scale on the left-hand side as the source gets weaker. This is called a **logarithmic scale** or **log scale**. The graph in Figure 4 has a logarithmic or log scale on the left. Figure 4 is drawn on **semilogarithmic graph paper** or **semilog paper**. The graph paper is "semi" or "part" logarithmic. The left scale is logarithmic; the bottom scale showing the date is an ordinary scale.

As a radiographer, you must be able to read decay graphs with log scales. Let's work some examples.

Example 1. The cobalt-60 source in Figure 5 was calibrated on July 1, 1979. Its activity at that time was 15 curies. Determine its activity on August 1, 1980. Determine its activity on July 1, 1983.

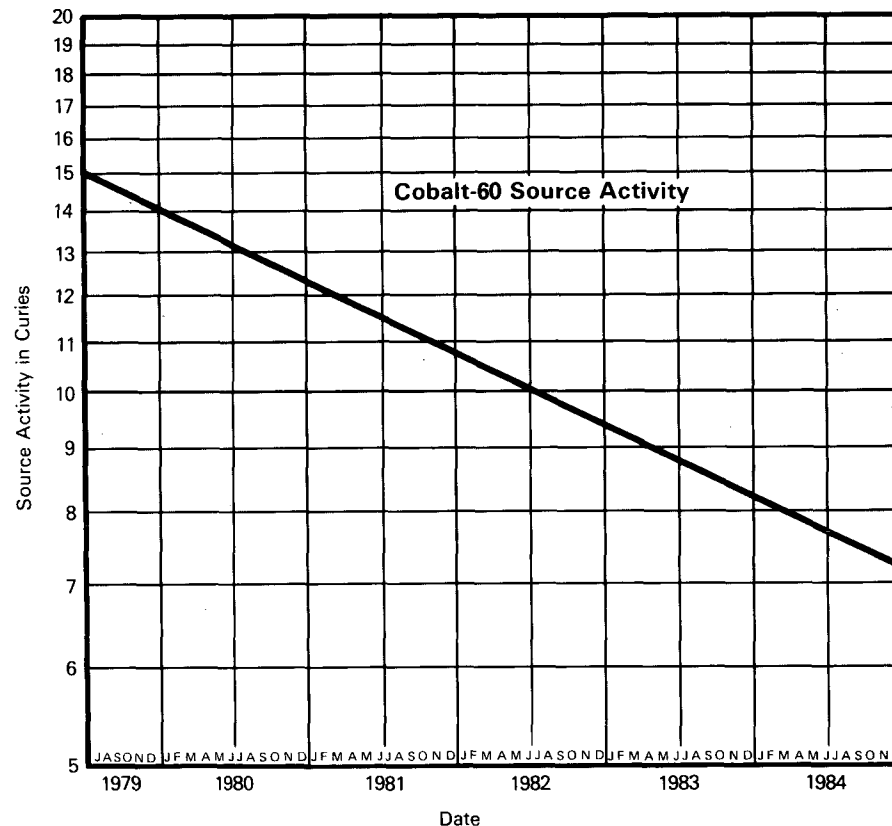

Figure 5. The decay of cobalt-60. Initial source activity on July 1, 1979, is 15 curies.

Solution. Use Figure 5 and locate the dates on the bottom scale. Move up to the diagonal line, then horizontally to the left. If you read the log scale correctly, you should get 13 curies for August 1, 1980, and 8.8 curies for July 1, 1983.

Let's check to see if these values are reasonable. The half-life of

cobalt-60 is about 5 years. From July 1, 1979, to July 1, 1983, the elapsed time is 4 years, which is almost one half-life. So, the value of 8.8 curies for July 1, 1983, is reasonable since 8.8 curies is closer to 7.5 curies (half of the original activity) than to 15 curies.

The value of 13 curies for August 1, 1980, is also reasonable. By January 1, 1980, the source had decayed

for 1 year and 1 month, which is much less than one half-life. Therefore, we should expect the activity for August 1, 1980, to be closer to the original activity of 15 curies than to 7.5 curies (the activity after one half-life).

Example 2. A decay curve like those supplied by a source manufacturer for an iridium-192 source is shown in Figure 6. The manufacturer calibrated this source on January 1, 1981. Its activity at that time was determined to be 105 curies. Determine its activity on April 1, 1981, and on September 15, 1981.

Solution. Locate the date on the bottom, follow a line up, then over to the left. The activity for April 1, 1981, is about 45 curies. The activity on September 15, 1981, is about 10 curies.

The initial activity of the iridium-192 source was 105 curies. This is more than the original 15-curie activity of the cobalt-60 source in Example 1. Yet, after 13 months, the cobalt-60 source still had 13 curies. At only 12 months (January 1, 1982) the iridium-192 source would have an activity of less than 4 curies. This is because the half-life of iridium-192 (75 days) is much less than the half-life of cobalt-60 (5 years). Iridium-192 sources decay at a much faster rate than cobalt-60 sources.

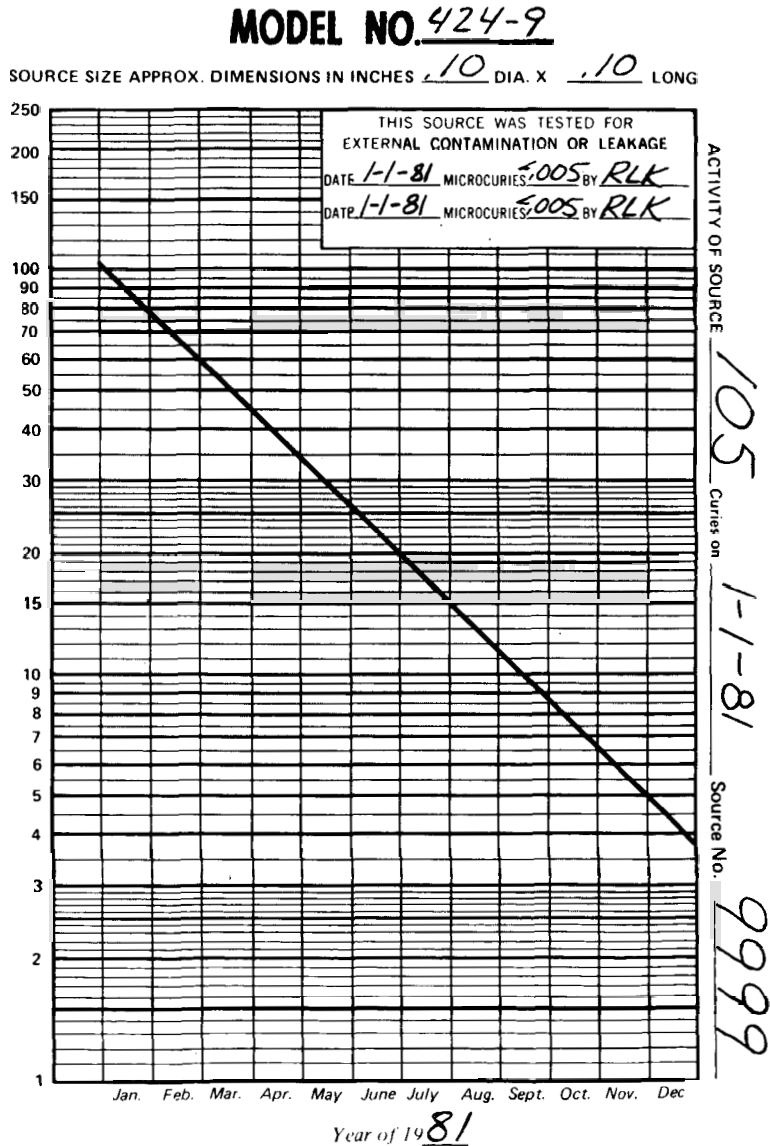

Figure 6. Chart of the decay of iridium-192 like those supplied by source manufacturers.

Can Radiography Sources Make Things Radioactive?

A sealed radiography source will not make other things radioactive unless the source is leaking. The metal objects that radiographers expose to radiography sources will not become the least bit radioactive. After the radiography source is removed from the area, no radioactivity whatsoever will remain.* Similarly, people exposed to sealed radiography sources do not become radioactive and are not in any way a radiation hazard to others.

In radiography, the radioactive materials are sealed inside a steel capsule (shown in Figure 2). If the capsule were to leak or be broken open, the radioactive materials could escape from the capsule. Radioactive materials could also escape if the source were not properly cleaned after manufacture or if some radioactive materials got into the weld in the source. The radioactive materials in the form of a dust could then be spread all over

the radiography camera and onto anything the camera touched. The radiographer and anyone else touching the camera could get the radioactive material on their skin and clothing.

This spread of radioactive materials is called **radioactive contamination**. Fortunately, the spread of contamination from radiography sources is very rare. NRC radiography licenses report only one or two sources they suspect of leaking per year on the average.²

While on anyone's skin, the radioactive material delivers a radiation dose to the person. The particles of radioactive material may be difficult to remove completely from the skin because some of the particles may work themselves into the skin just like grease gets worked into the skin of an auto mechanic.

If the particles get into the air, they may be inhaled. If the particles of radioactive material are inhaled, some of them will be deposited in the lungs and will expose the person to radiation from *inside* the body. Radioactive decay would cause the amount of radioactivity to be gradually reduced. Also, the biological processes in the body would cause most of the radioactive material to be excreted (for example, through the urine), but this is a much slower process than cleaning the skin.

*Except for neutron radiography, where a little radioactivity will remain. But neutron radiography is not discussed in this manual.

In several accidents, people exposed to sealed radiation sources have been refused admittance to hospitals. The hospital workers mistakenly thought the people were radioactive and would be dangerous to others or would contaminate the hospital with radioactive material.

In July 1980, a radiographer in Pennsylvania was at first refused admission to a hospital for this reason after a traffic accident.³ In the

accident, the radiographer was shaken up and the radiography camera was thrown from his truck into some weeds at the side of the road. The radiographer acted properly. He told the police that a radiation source was present, had them secure the area around the camera, and told them to telephone the company radiation safety officer (RSO). The RSO recovered the radiography camera, which was undamaged. The police apparently

called the hospital to tell them that they were sending a person injured in a radiation accident. The hospital called the NRC. Eventually, the hospital personnel were convinced that the radiographer was not radioactive.

In case you are ever involved in a similar situation, you should be prepared to explain (1) that you *may* have been exposed to radiation but you are not contaminated

with radioactive material, (2) that you are not emitting radiation, and (3) that you are not a hazard to others.

A sealed radiography source does not make you or anything else radioactive. The rare source that does leak can cause radioactive materials to be spread to its surroundings, although most leaking sources cause little such radioactive contamination.

Questions

1. What is *radioactivity*?
2. What is a *radioactive isotope*?
3. With respect to a radioactive source, what does the term *curie* refer to?
4. If you have 3 sources of 5, 10, and 15 curies activity and you place them together, what is the activity of the combined source?
5. Explain the *half-life* concept for radioactive materials.
6. If we start with an 80-curie source, how much activity remains after one half-life? After 4 half-lives?
7. From Figure 5, what would be the activity of the cobalt-60 source in September 1981? In December 1981? In October 1983?
8. From Figure 6, what would be the activity of the iridium-192 source on April 15, 1981? On October 20, 1981? On December 10, 1981?
9. What is *radioactive contamination*?
10. Does a gamma radiography source make the radiographed objects radioactive?

4

What Are The Harmful Effects Of Radiation?

Prompt Effects of Radiation

Delayed Effects of Radiation



Scientists have long known that exposure to radiation can have harmful effects in humans. Some of the harmful effects that radiation can cause are radiation burns, cancer, and genetic defects in future generations. Even death can occur soon after very large doses of radiation are received.

Scientists have known for more than 50 years that these types of health effects can result from radiation exposure. They have studied these effects in people who have been exposed to radiation in medical treatment, in radiation accidents, or as a result of exposure to atomic bomb radiation in Hiroshima and Nagasaki. Scientists have also studied the effects of radiation on animals that were exposed to radiation in experiments.

Radiation burns were first noted in 1896 within a month of Roentgen's announcement of the discovery of x-rays.¹ Within a year or two it was widely known that x-ray workers had to take some precautions to avoid injury. Some of the early x-ray workers took the warnings seriously and protected themselves. Others, although warned, did not take precautions. A combination of optimism and enthusiasm over an exciting new discovery seems to have led them to abandon all caution.¹ These people suffered serious radiation burns. In fact, by about 1905, the dangers from exposure to



radiation were well enough understood and believed that the chronic radiation injuries seen among the earlier workers became quite rare.

Early experimenters with natural radioactivity also suffered burns caused by radiation.² Becquerel burned himself by carrying a sam-

ple of radium in his pocket. Both Marie and Pierre Curie received radiation burns on their skin from working with radium.

By 1905, it was known that excessive exposure to radiation could cause cancer. Large repeated doses of radiation to the hands of workers frequently caused fatal skin cancer, as shown in Figure 1. Many of the early medical radiologists died of this type of skin cancer. Some suffered over 100 amputations each in an effort to stop the progress of the cancers in their bodies.¹ Pieces of the affected part of their bodies were amputated, often starting with the fingers, one joint at a time. In 1922 in Hamburg, Germany, a memorial was dedicated to 169 of these pioneer scientists who died as a result of the radiation they were exposed to during their work.² Marie and Pierre Curie both developed leukemia, perhaps from exposure to radiation.²

Figure 1. Two views of the right hand of a pioneer medical radiologist. The first injury to this radiologist was seen in 1899, 3 years after the discovery of x-rays was announced. The hand was amputated in 1932, and death from cancer occurred in 1933. Cancerous conditions like this were caused by repeated doses of radiation adding up to many thousands of rems of radiation. Because early radiation workers learned of precautions that should be taken to prevent excessive exposure, the chronic irritation and fatal skin cancer shown here are no longer seen.

By the late 1920s, scientists knew that radiation caused genetic defects in the offspring of insects that had been exposed to radiation. The scientist who discovered this, Herman Muller, later won the Nobel Prize.

Prompt Effects of Radiation

Very large doses of radiation can cause harmful health effects within hours or weeks. Such effects are called **prompt effects** because they appear fairly soon after exposure. The prompt effects are **radiation burns** to exposed skin and **radiation sickness**, which can be fatal.

Other radiation effects occur years after exposure. These are called **delayed effects** because they do not occur right away. **Cancer** and **genetic defects** in offspring, which occur years after exposure to radiation, are examples of delayed effects.

We will discuss prompt effects of radiation first because of their special importance to radiographers.

Radiation Burns

Radiography accidents commonly result in high radiation doses to a small part of the body. A part of the body may receive a radiation dose

great enough to cause **radiation burns**.³ Most often the hands and fingers receive the burns, but occasionally other parts of the body are affected.

Burns to the hands can result when a radiographer touches or almost touches a source for just a few seconds. The *temperature* of the source is not high, but the *radiation intensity* at the surface of a radiography source is extremely high. The burns are caused by radiation, not heat, so we can't feel anything wrong. Unfortunately, our bodies do not have a reflex action to cause our hand to pull away from radiation as we do from heat.

Radiation burns, equivalent to a first degree heat burn or mild sunburn, first become evident when the dose to a portion of the body exceeds about 600 rems at one time. The person receiving the burns may feel a sensation of warmth or itching within a few hours after being exposed to the radiation. An initial reddening or inflammation of the affected area usually appears several hours after exposure to the radiation and fades after a few more hours or days. The reddening may reappear as late as 2 to 3 weeks after the exposure. A dry scaling or peeling of the irradiated portion of the skin is likely to follow. Medical attention should be sought; but aside from avoiding further injury and guarding against infection, medical treatment is not required. Recovery should be fairly complete.

If you have been performing radiography, an unexplained reddening of your skin may or may not be a sign that you have received a serious **radiation overexposure**. You should bring this condition to the attention of the radiation safety officer (RSO) unless you are fairly certain that the reddening is from other causes.

If a dose of 600 rems is delivered to the eye within a day or two, damage to the eye can occur. At this dose, the lens of the eye starts to become cloudy instead of being clear, a condition called a **cataract**. Fortunately, there are no reported instances of cataracts ever having been caused by a radiography source.

If a part of the body receives a dose over 1,000 rems at one time, serious tissue damage like a second degree heat burn results. First inflammation occurs, followed by swelling and tenderness. Blisters will form within 1 to 3 weeks and will break open leaving raw, painful wounds that may become infected. Hands exposed to such a dose become stiff and finger motion is often painful. Medical attention is necessary to avoid infection and relieve pain.

If the dose is not too great, the visible damage may heal within several months or so, but some permanent damage to the tissue

such as thinning of the skin, scarring of the underlying tissue, or damage to blood vessels may occur. This damage, like other scars, will make the exposed tissue more subject to injury and more tender to pressure or marked temperature change in the future.

At 2000 to 3000 rems, an injury resembling a scalding or chemical burn is caused. Figure 2 shows such burns and blisters on the hands of a radiographer burned by radiation. Intense pain and swelling occur within hours. For this type of radiation burn, medical treatment to reduce pain is urgently needed. The injury may not heal without surgical removal of exposed tissue and skin grafting to cover the wound. Damage to blood vessels also occurs, as shown in Figure 3.

Future medical problems with such highly exposed tissue can be expected (such as pain, low resistance to injury, and reopening of the wound).

When more than 3000 rems is received at one time, tissue is completely killed and must be surgically removed.

If a radiation dose of 5,000 to 10,000 rems is received gradually over a number of weeks or longer, a chronic irritation, inflammation, dryness, and itching of the skin will result.³ Once this condition has developed, it seldom heals completely. Periodically, open sores



Figure 2. Radiation burns on hands. Twenty-four days after the accident, blisters are breaking and dead skin is sloughing off, exposing raw skin underneath. In this case, amputation of the fingers was finally necessary.

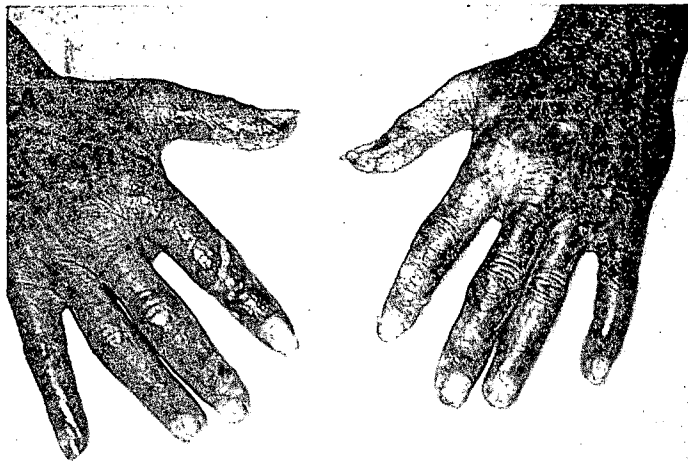

may erupt. The skin is half dead, half alive, and its regenerative and recuperative powers are sharply reduced. Malignant skin cancer occurs in a large proportion of these cases. However, such malignant skin cancers have not been observed in radiographers who have

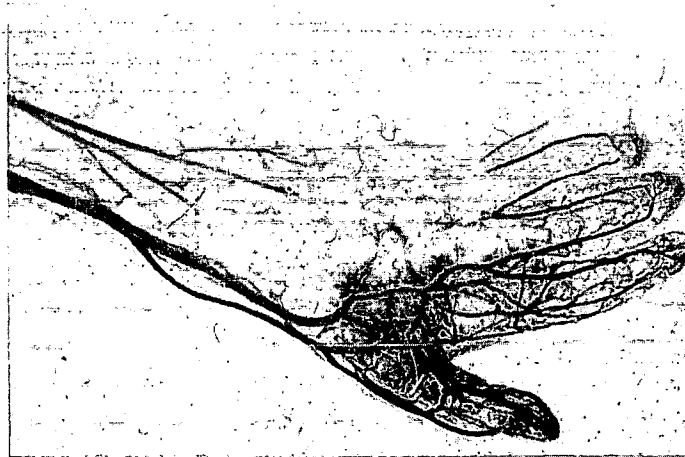

Figure 3. Radiation burns severely damage blood vessels. The x-ray above was taken after a dye had been put in the blood to give contrast to the picture. Circulation has been lost on the top. The hand is that of an Algerian boy who picked up an iridium-192 source that fell from a truck.

received burns from a large dose of radiation at one time.

A Severe Radiation Burn

A very serious radiation burn from a radiography source occurred in California in 1979.⁴⁻⁶ The burn was caused when a man found a 28-curie iridium radiography source that had been accidentally left at a jobsite by a radiographer. The man was not a radiographer and did not know what the source was. He picked it up, put it in his back pocket, and left it there for about 45 minutes. The circumstances leading to the source being left at the jobsite are discussed in Chapter 11.

The radiation dose to some of the man's right buttock exceeded 20,000 rems.⁶ At a depth of about 3 inches, the dose exceeded 1000 rems. Much of the burned tissue had to be removed by surgery.

The man became nauseated about an hour after the exposure. Nausea is a common symptom after the stomach receives a dose of radiation exceeding about 100 rems. In this case, the source was carried close enough to the stomach to cause it to receive a dose of roughly 100 to 200 rems. About 6 hours after exposure, the man noticed a burning feeling and a reddening of his buttock. The burning and reddening got worse, and 2 days after the exposure, the man went to a doctor.

In the first few days after exposure, radiation burns are hard to recognize because they are so much like other skin irritations. The doctor thought the injury was caused by an insect bite.

The burn got worse and worse until it became a large, open sore. The patient was hospitalized 17 days after the exposure. After 3 days of persistent questioning by the attending doctors, the man told about having the radiography source in his pocket. At this point the doctors realized that he had a radiation burn.

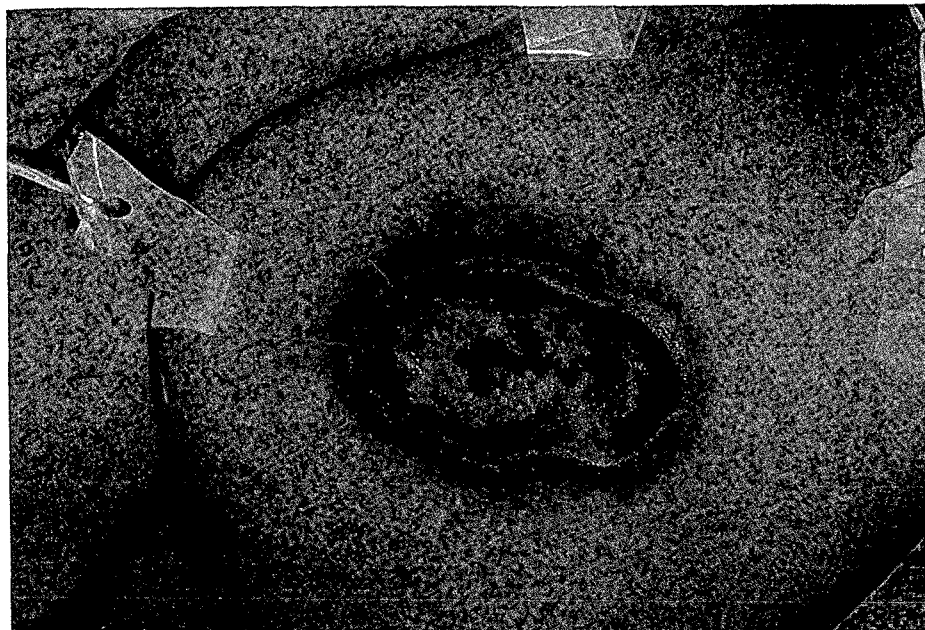

Figure 4. Radiation burn on the buttock of a worker 31 days after he put an iridium source in his back pocket.

By this time, the man had an open wound about 4 inches in diameter and almost 1 inch deep. A second, but less severely burned area, was nearby. A picture of the wound 31 days after exposure is shown in Figure 4. The wound caused continuous severe pain.

To treat the burn, doctors surgically removed the dead tissue. A thick piece of skin was cut loose from the man's thigh, folded over, and sewn onto the wound in order to close it. The skin flap 50 days after the accident is shown in Figure 5. Six

months after the accident, the skin flap had an edge that was not healing, and a nearby burned area was deteriorating (Figure 6). Ten months after the accident, a second skin flap was sewn onto the smaller wound. At 19 months after the accident, doctors have not yet been completely successful in closing the wounds (Figure 7). Further reconstructive surgery will be necessary in the future. Two years after the accident, the man still walks with a limp and experiences pain where he was burned.

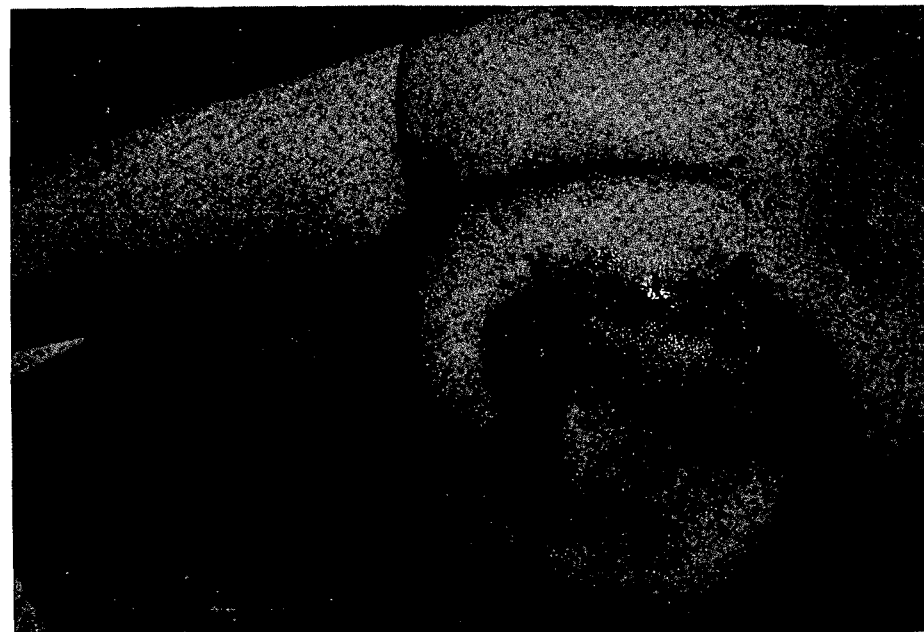

Figure 5. A skin flap has been sewn over the wound to close it (50 days after the accident).

Other Examples

A similar accident happened in 1968 in India.⁷ A man found a radioactive source and put it in his back pocket. He suffered a serious radiation burn as a result. Years later, a large scar remained. An even worse accident happened in Argentina, where a man found a source and put it in his front pocket.⁸ Unfortunately, this placed the source closer to the arteries that carry blood to the legs. The arteries disintegrated because of radiation damage, and both legs had to be amputated.

Dropped radiography sources have also been picked up by workers in Germany (1968), Japan (1971), and South Africa (1977), resulting in serious radiation burns.

Fortunately, such severe radiation burns are rare. Companies licensed by the NRC reported visible radiation burns less than once a year between 1971 and 1980 (see Appendix F, Table 2). Since about two-thirds of the companies performing gamma radiography in the U.S. are licensed by the states, the total

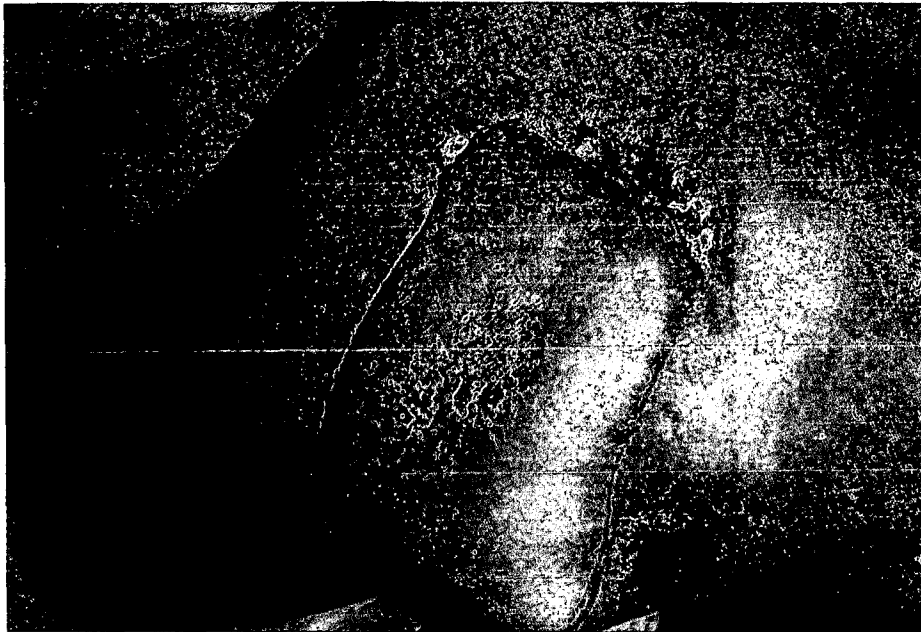

Figure 6. Six months after the accident.

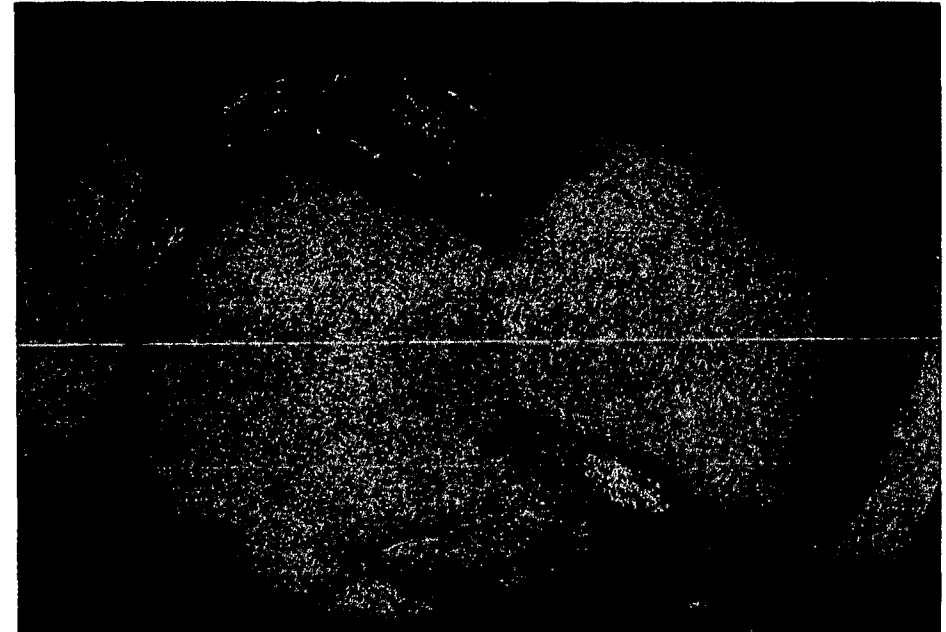

Figure 7. A second skin flap has been added 19 months after the accident. But the wound has still not healed.

Note: Reproduction of Figures 4-7 is prohibited. Permission to publish these photographs was obtained for this manual only.

number of visible burns is probably one or two per year on the average.

Radiographers can prevent such accidents by keeping radiography sources under their control. By not using survey meters, radiographers can lose control of their sources and fail in their responsibility to protect themselves and others.

Radiation Sickness

If a large dose of radiation is delivered to just one part of the body, like a hand, there would be local-

ized burns, but the person would survive. However, if a large dose of radiation is delivered to the torso of the body in a short period of time, severe illness or even death can occur within a few days or weeks.^{9,10}

A dose of 100 rems or less delivered to the torso usually will not produce noticeable symptoms of illness. As the dose increases, symptoms such as nausea, vomiting, and perhaps diarrhea occur within a few hours after the exposure. These are symptoms of **radia-**

tion sickness. Two or three weeks later, other symptoms may appear such as loss of hair, loss of appetite, general weakness, a feeling of ill health, purple spots on the skin from internal bleeding, fever, and continuing diarrhea.

If the entire body is exposed to a radiation dose exceeding 500 rems in a day or less, death is likely within a few weeks because the bone marrow, which produces the blood cells, can no longer produce

enough cells. Below about 500 rems, recovery is likely with medical care although the exposed person can expect to suffer several months of illness. If the radiation dose delivered to a person is spread over several weeks, a person may survive doses as large as 1000 or 2000 rems.

Only one radiographer in the world is known to have died from the prompt effects of radiation and, in that case (July 1981), the exposure was probably not accidental. No member of the American public is

known to have died from the prompt effects of radiation caused by a radiography source. However, in Mexico, China,¹¹ and Algeria,¹² people have died from large radiation exposures from radiography sources that were not properly kept in their shielded storage containers.

Deaths from a Radiography Source

In a well-known accident in Mexico, several people died of radiation sickness caused by a radiography source.¹³

On March 21, 1962, a construction watchman was given a 5-curie cobalt-60 source for safekeeping by his employer.¹⁴ The watchman did not know what the source was, but he assumed it was valuable because the employer told him to store it in a safe place and to make sure no one went near it. Since the watchman knew that valuable property should be guarded carefully, he took the source home with him. The source was in a lead container, but presumably the watchman removed the source from the container out of curiosity to see what was valuable about it.

Sometime between March 21 and April 1, his son found the source and placed it in a front pocket of his trousers. On April 1, the watchman's wife found the source and placed it in a drawer in the kitchen.

On April 17, the watchman's mother-in-law came to live with the family to help care for the boy who

by that time was sick from the radiation. At this time she noticed the blackening of the glasses that had been close to the source in the drawer.

On April 29 the boy died. On July 19 his mother died. Both died of radiation sickness. It was later estimated that the boy had received a dose between 3,000 and 5,000 rems and his mother a dose between 2,000 and 3,000 rems.

On July 22, 1962, the employer came to the house, claimed the source, and took it away. The family did not suspect the tragedy it had caused. In August, the watchman's 2-½ year old daughter became very ill. On August 13, an alert physician suspected for the first time that the common symptoms of the members of this family might be due to radiation. On August 18, the little girl died. It was later estimated that she had received between 1,400 and 1,900 rems.

On August 20, the watchman and his mother-in-law were admitted to the hospital with what appeared to be radiation exposure symptoms. Since he was away from the house a lot, the watchman had been exposed on and off, and it is believed that he had received less exposure than the other members of the family. He was discharged from the hospital on September 6, but kept under close medical observation. His mother-in-law did not survive. She died on October 15. It was estimated that she received between



Figure 8. As a radiographer, you have a responsibility to make sure that radiography sources are not left where they can hurt or kill someone. In several foreign countries children have found radiography sources and brought them home. Deaths have resulted.

1,500 and 3,000 rems over the period of time she was exposed.

This tragedy could have been avoided if the radiography company had kept better control of its sources. A radiography source

must not be left in the hands of anyone who does not know how dangerous it is.

Delayed Effects of Radiation

Fortunately, exposure to doses of radiation large enough to cause radiation burns or radiation sickness are very rare. As we said, in the United States visible radiation burns happen in the radiography industry only about once or twice a year on the average. The low doses

of radiation that most radiographers receive have no such dramatic effects. But these low doses may have effects that take many years to appear. Low doses of radiation may cause cancer and may cause genetic defects in the children of exposed people. It has not been shown scientifically that these effects result from radiation doses within legal limits, but agencies that regulate radiation exposure assume that low doses of radiation can have such effects.

Cancer

Most scientists accept the possibility that exposure to radiation, no matter how little, may have some risk of cancer associated with it. However, most exposed people will have no ill effects from the radiation they receive. About one-fifth of the U.S. population will die of cancer, as shown in Figure 9. A few of these cancers might be caused by

radiation, but scientists believe that most cancers have other causes. If a person does get cancer, it is impossible to know whether the cancer was caused by exposure to radiation or whether the cancer would have occurred anyway from some other cause. *Cancer caused by radiation cannot be distinguished from cancer from other causes.*

Scientists do not yet know exactly how cancer is caused in humans. But it appears that most cancers apparently are caused by some sort of a defect or damage to the long complicated molecules that control how the cells divide to make more cells. These important molecules, illustrated in Figure 10, are called **DNA** molecules. (DNA is an abbreviation for the chemical name, deoxyribonucleic acid.) However, scientists do not yet understand exactly how the DNA molecules are damaged.

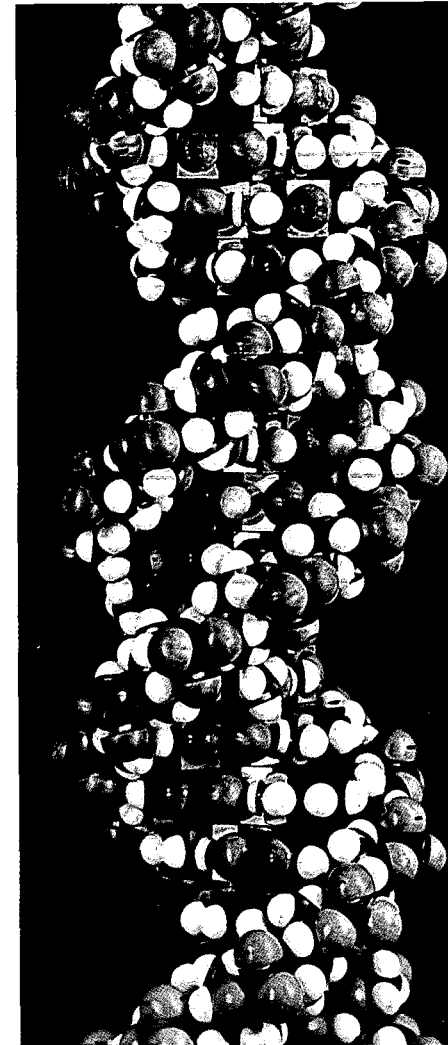

Figure 10. The DNA molecule, which forms the basis for all life on earth, is a large molecule with the shape of two spirals twisting around each other, much like the banisters on a spiral staircase. Each of the balls in the picture above represents an atom of some element like carbon, oxygen, or hydrogen. Cancer is believed to be caused by damage to DNA that starts to malfunction.

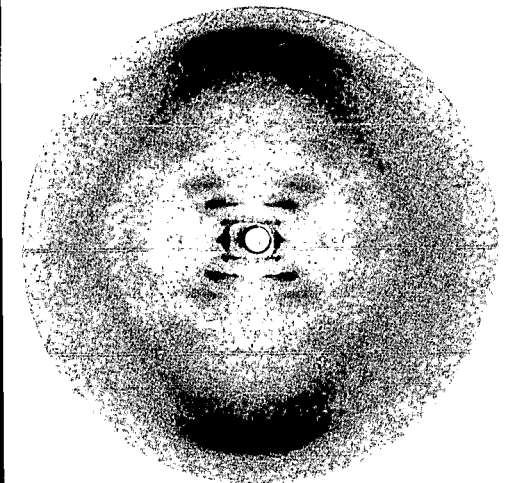

Figure 11. A radiograph (shown above) revealed the structure of DNA to scientists, thereby telling them how living cells can reproduce copies of themselves. A Nobel Prize was awarded for this discovery. The radiograph shown above is different from normal radiographs. A normal radiograph is made by x-rays or gamma rays that pass directly through the material being examined. This radiograph was made in 1951 by the x-rays that were scattered or reflected out of a narrow x-ray beam by the DNA. The diagonally placed spots indicate the spiral structure as shown in Figure 10.

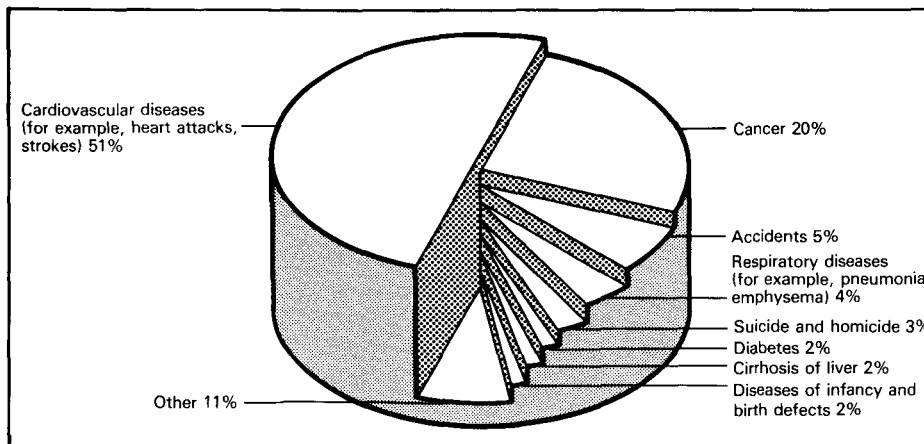

Figure 9. Causes of death in the U.S. in 1977.¹⁵ One-half of the deaths are from heart diseases. One person in five dies of cancer.

The DNA contained in each cell of the human body contains the "instructions" or "blueprints" for how to build an entire person. A complete human being develops from one single cell. The DNA makes a copy of itself, and the cell with two sets of DNA divides into two separate cells. This is how a human is formed from a single cell, how children grow bigger, and how new cells are formed to heal scratches and cuts on the skin.

Scientists believe that cancer occurs when something goes wrong with the way the DNA reproduces itself and creates new cells. **Cancer** is the uncontrolled growth of cells. Cells reproduce without control, eventually crowding out and killing other cells needed in the body.

The exact mechanism by which ionizing radiation (or chemicals) causes cancer is not known, but scientists can see that radiation damages the cell's essential DNA (Figure 12). And scientists accept as a prudent assumption the possibility that even low doses of radiation may increase a person's chance of getting cancer. The lower the dose, the less the assumed risk.

As a radiographer, you will be exposed to some radiation. There may be a risk of cancer because of that exposure. The important question is, "How large is your risk of cancer because of radiation exposure?"

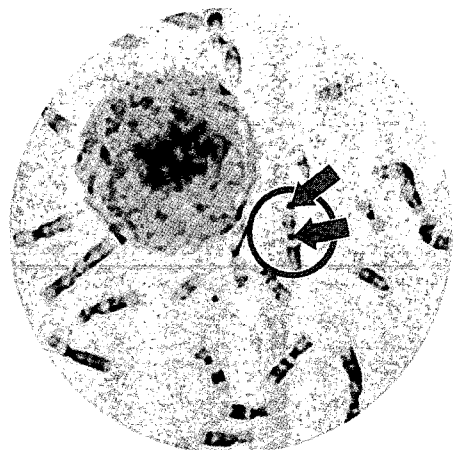

Figure 12. Scientists can see the damage that radiation causes in cells by using microscopes. The large ball is an intact human cell. The small pieces are chromosomes, made of DNA, from a cell that has been chemically broken apart. One of the chromosomes is abnormal. It has two indentations because of two chromosomes fused together. Radiation can cause this to happen. By counting the number of such abnormalities in a blood sample, scientists can estimate the dose that the person received.

How Large is Your Cancer Risk?

We don't know exactly what the chances are of dying of cancer because of a radiation dose, but we do have good estimates of the upper limit of the cancer risk. In fact, the estimates of cancer risk because of radiation exposure are probably more reliable than the estimates of cancer risk from any other hazardous material such as dangerous chemicals. This is because radiation has been studied more than any other hazardous material.

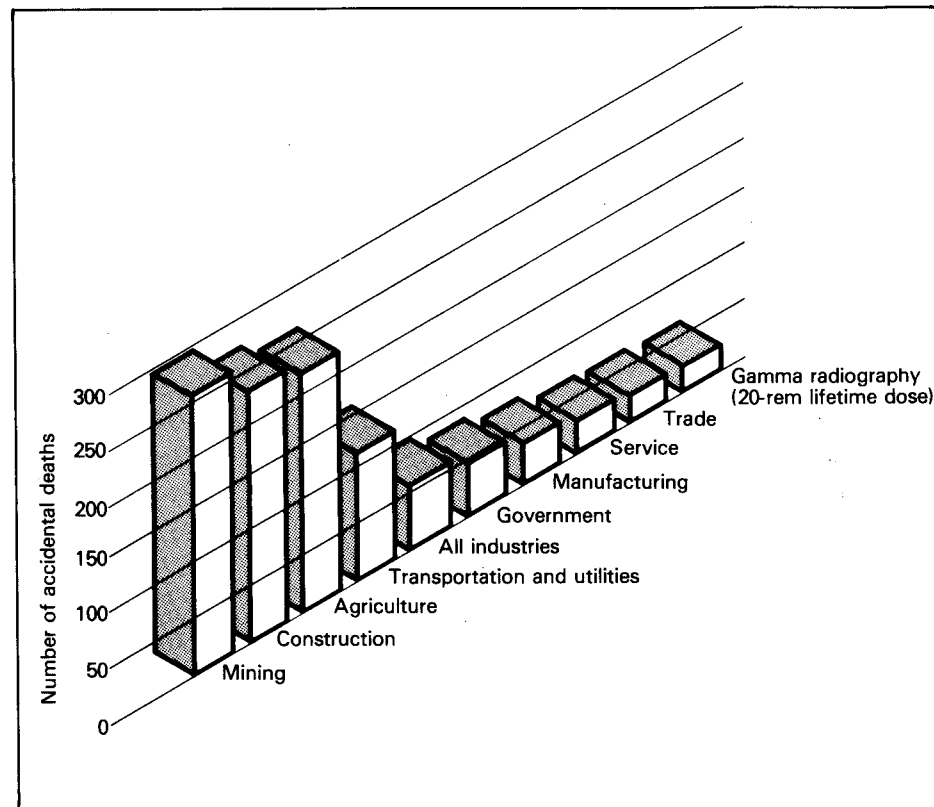

Figure 13. Number of accidental deaths for 10,000 workers for their working lifetimes in various industries compared to the radiation risk faced by industrial radiographers.¹⁷

chance in 10,000.*¹⁶ This means that each rem you receive during your lifetime adds 1 chance in 10,000 of cancer.

In the United States, one person in five dies of cancer. Most scientists would agree that for every one rem of radiation that a person receives, the chance of dying from cancer is increased by no more than one

*We must distinguish between the risk of *getting* cancer and the risk of *dying* of cancer. Of those who get cancer, roughly half die from the cancer. In this chapter we discuss the risk of *dying* from cancer. For every person who *dies* from a radiation-caused cancer, one other person would *get* a radiation-caused cancer, but would not die as a result of that cancer.

1rem = 1day

In Chapter 2, we estimated that about 10,000 people are regularly engaged in taking radiographs in the United States. On the average, these actively working radiographers receive a dose of about 1 rem per year, as we noted near the end

of Chapter 2. If we add up the radiation dose to all of these workers, they would receive about 10,000 rems per year. This means that cancer caused by the radiation dose to all radiographers in 1 year might claim the life of one radiographer.

Figure 14. One way to think about radiation risk is to think about how much loss of life expectancy it causes. *On the average*, a person exposed to 1 rem loses 1 day of life expectancy. Similarly, 1 millirem causes very roughly, *on the average*, the loss of 1 minute of life expectancy because of the increased risk of early death by cancer.

Reports filed with the NRC show that workers who spend their lifetimes working as radiographers can expect to receive lifetime doses, on the average, of about 20 rems (see Chapter 2). A dose to each worker of 20 rems might result in up to 20 cancer deaths per 10,000 workers. Remember that 20 rems is the *average* lifetime dose for radiographers. Some get more. If a worker receives a lifetime dose of 100 rems, the worker's chance of dying of radiation-caused cancer might rise to 1 chance in 100, or 1%. This 1% would be added to the 20% chance of cancer death that an average American faces.

This radiation risk can be compared to the risks of accidental death faced by workers in other industries. Figure 13 shows such a comparison. The radiation risk faced by industrial radiographers, on the average, is low in comparison with risks of accidental death faced by workers in other occupations. However, the total risk to radiographers is higher than shown here since the risks from other causes of death must be added to the risk from radiation.

Figure 15. Estimated loss of life expectancy from industrial accidents compared to the radiation risk faced by industrial radiographers.²⁰

Another way of comparing a radiographer's risk from radiation to the risks in other industries is to compare days of life lost. Scientists have calculated that 1 rem of radiation may, *on the average*, result in the loss of 1 day of life expectancy.¹⁸ So the radiation exposure you can expect to receive in a lifetime as a radiographer may cost you, on the average, 20 days of your life. We emphasize *on the average* because most radiographers will suffer no loss of life expectancy. But the unfortunate radiographer who does get cancer will, on the average, lose perhaps 15 years of life expectancy.¹⁹

The radiographer's average loss of life expectancy caused by radiation exposure is compared to loss in life expectancy caused by accidents in other industries in Figure 15. The radiation risk to radiographers is smaller than the risk of accidents in many other jobs. Remember, however, that a radiographer also faces other risks such as traffic accidents. The radiographer's risk from *all* risks is larger than that shown in Figure 15, but we do not know the size of the other risks.

The loss of life faced by radiographers can also be compared to other risks that we face in life. Figure 16 shows that the risk from radiation faced by radiographers is small when compared to many other risks. Perhaps what is most

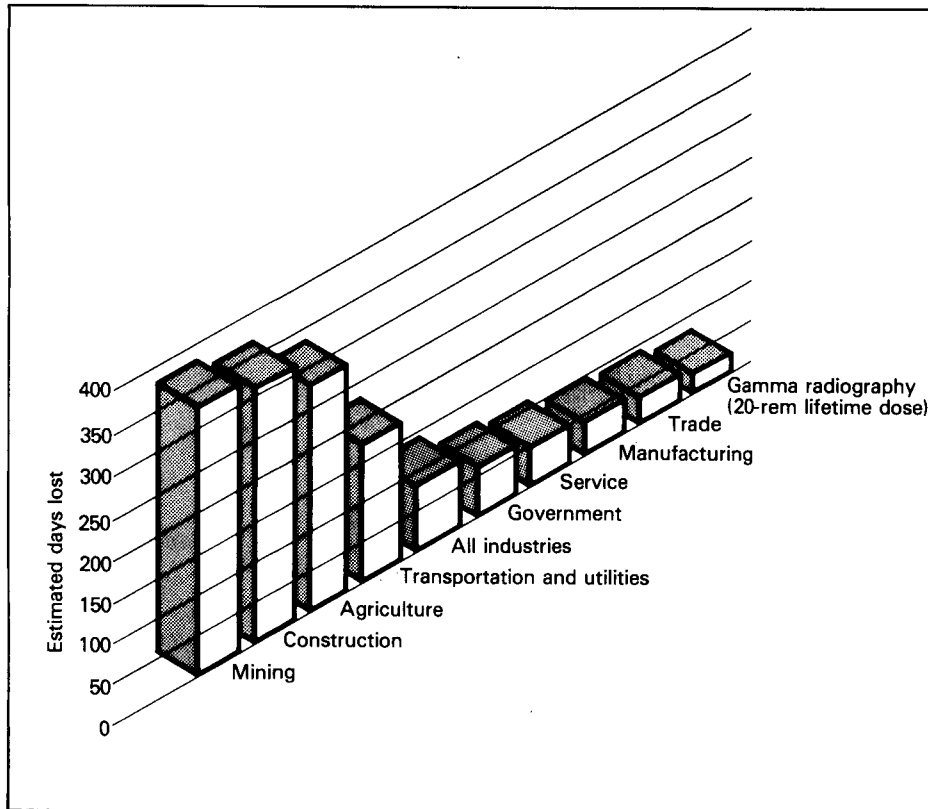

striking about Figure 16 is the risk from smoking, which stands in a class by itself.

Another comparison of a radiographer's risks to the risks faced by other workers is a direct comparison of the number of probable cancer deaths. Unfortunately, we do not know nearly as much about the cancer risks from other things as we know about the risks from radiation. However, we do have one point for comparison. The U.S. government's Council on Environmental Quality has estimated that job-related exposure to chemicals and other substances causes very roughly about 400 cancer deaths per 10,000 American workers.²¹ This includes the cancer risk from such things as a lifeguard's added exposure to sunlight, a taxi driver's exposure to smog, and a cabinet maker's exposure to wood dust. On this basis, the average American industrial worker faces roughly 20 times the cancer risk that the average radiographer gets from radiation. In fact, a radiographer could face more risk of cancer from chemical substances on the job than from radiation.

Genetic Defects from Radiation

Genetic defects from radiation are effects in which radiation has damaged the reproductive cells in a person. A damaged cell can be a cell from which a future child of that person is formed. The child thus inherits damaged or defective genes.

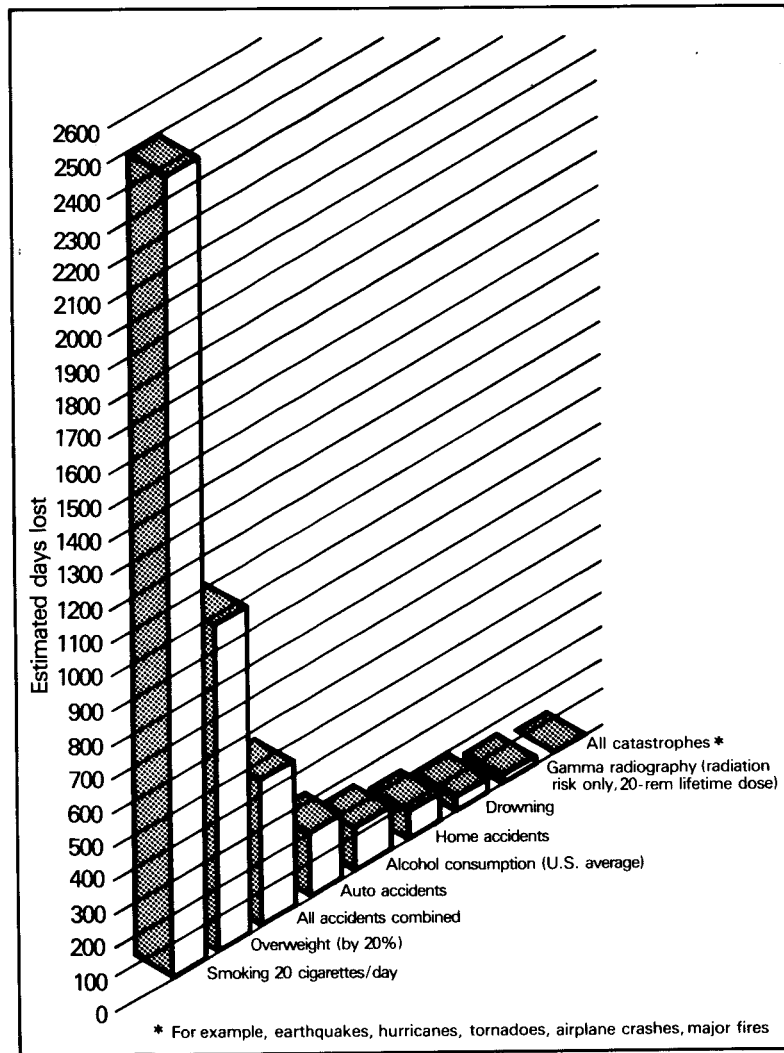

Genetic damage does not imply any sexual disability or problem. Damage to the genes implies a defect in the blueprints to construct a

Figure 16. Estimated loss of life expectancy from some risks in life compared to a radiographer's risk from radiation.²⁰

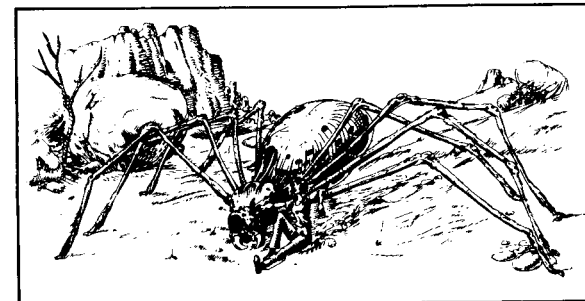

Figure 17. Radiation does not cause mutations like this. Comic books and science fiction movies have long used stories where exposure to radiation caused some mutated monster to be created (giant ants, spiders, crabs, blobs, and so forth). In reality, radiation causes no such things. Mutations caused by radiation are just like those that can occur naturally.

complete organism from the single damaged cell. A change in the genes can also be called a **mutation** of the genes.

Since 1927, scientists have known that radiation can cause genetic defects. The early evidence was obtained from experiments with insects. Increased numbers of genetic defects were found in the descendants of insects that had been exposed to radiation. The genetic defects were the same types that are found naturally. Subsequent experiments with animals had similar results. Radiation increases the number of genetic defects but does not result in different types of defects than those that occur naturally. The danger of radiation exposure is that it can *increase the number* of genetic defects that do occur.

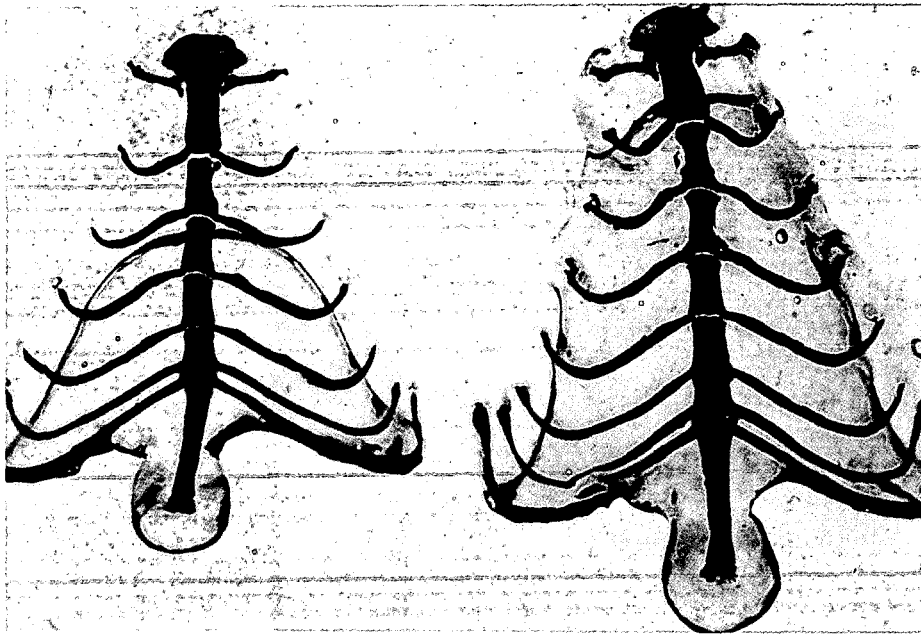

Figure 18. Genetic defects in the skeleton of a mouse. The bones on the left are normal. The mouse on the right has an extra piece in its breast bone and an extra set of ribs caused by a radiation-induced genetic defect. Like those shown here, most genetic defects are not externally visible.

Most people who suffer from a genetic defect do not know they have the defect because there are usually no easily detectable signs. Some genetic diseases are obvious. For example, two well-known diseases caused by genetic defects, color-blindness and hemophilia (a failure of the blood to clot), are readily detectable. Unlike those two, most other genetic diseases are not easily detectable.

Often doctors cannot say whether a person has a particular genetic defect or not. The genetic defect most often causes some cells in the body to produce some essential protein, enzyme, or hormone in reduced quantity or with reduced potency. The effect of such defects on a person is usually that the person is not quite as healthy and vigorous as normal.

Scientists believe that at least 10% of all people born have a genetic defect serious enough to cause disease or ill-health during their lifetime.²² About 1% of all people born

have genetic defects severe enough to cause malformation of their bodies or serious or crippling disease. Probably at least half of all genetic defects are inherited from the parents. The other defects are new and did not exist previously in either parent.

Most new genetic defects are a natural event with no outside cause. The process by which a single cell from each parent creates an entirely new human being is so complex that there are many chances for error. When the errors are large, the development of a fertilized egg into a human being usually fails. A fetus (unborn child) may abort before a woman even knows she is pregnant. About half of all spontaneously aborted fetuses have serious genetic defects.

Genetic defects that cause the most serious disorders usually are eliminated from the population within one to a few generations because the carriers do not survive to reproduce. On the other hand, those genetic defects that cause less severe disorders will affect more people because the carriers survive to reproduce.

It is possible that a genetic change will be beneficial. But beneficial changes are very, very rare. The human body is a very complex machine, far more complex than a jet aircraft, for example. If someone makes a random change in the aircraft's equipment, the aircraft's performance is far more likely to be harmed than improved.

Scientists estimate that the chance that 1 rem of radiation will cause a genetic defect in a descendant child of the person exposed to radiation is about one-third the chance that the radiation will cause a fatal cancer in the person.²³ Previously we estimated that 1 rem of radiation would result in no more than 1 chance in 10,000 of a cancer death. The risk of a genetic defect in a child born to a person exposed to 1 rem of radiation is less than one-third chance in 10,000 and may be 10 times smaller. Because genetic defects are less likely than cancer and because the consequences are not as great (decreased health rather than death), the risk of cancer is more significant than the risk of genetic defects.

These estimates of genetic defects caused by radiation exposure are based on experiments with insects and animals. Genetic defects that could be associated with radiation have not been observed in any group of humans. For example, studies of the children of the Japanese atomic bomb survivors, thousands of whom had very large doses, did not detect any more genetic defects than normal.

Radiation Exposure of Pregnant Women

When a pregnant woman is exposed to radiation, there may be damage to the unborn child. The reason is that the unborn child is more sensitive to radiation than an adult, especially during the first 3 months after conception. We are not talking here about genetic defects that can be passed from generation to generation. Rather we are talking about developmental defects affecting only the unborn child.

The NRC provides information about the biological risks to the unborn child from exposure to radiation in relation to other risks encountered during pregnancy in NRC Regulatory Guide 8.13, "Instruction Concerning Prenatal Radiation Exposure." Every woman of child-bearing age who works as a radiographer should read the instructions in this guide. The licensee (your company) is responsible for providing workers instruction about risks associated with radiation exposure, including specific instruction about exposure risks to the unborn, prior to working in a restricted radiation area.

How Sure Are Scientists About Delayed Effects of Radiation?

If you only read newspapers and watch television as a source of information about radiation, you

would be likely to conclude (1) that the harmful effects of radiation were first noticed in the last few years, (2) that scientific study of the effects has been neglected in the past, (3) that radiation produces more horrible effects than other hazardous materials, and (4) that there is enormous uncertainty in the effects of low doses of radiation. All four of these impressions are incorrect. We've already discussed in this chapter how the first three of these impressions are wrong. Let's discuss the uncertainty in our knowledge of radiation doses below legal limits.

Scientists working on determining radiation effects will indeed say that their estimates of the effects of low doses of radiation are uncertain. But what do they mean when they say this?

They mean that the effects of doses of radiation below legal limits are *too small* to be measured directly.

Why can't the effects be measured directly?

One reason is that cancers caused by radiation cannot be distinguished from cancers resulting from other causes. Another reason is that the variability of the cancer death rate attributable to sex, age, lifestyle, race, and unknown factors adds uncertainty to any estimate of the expected number of cancer deaths in a particular group of people.

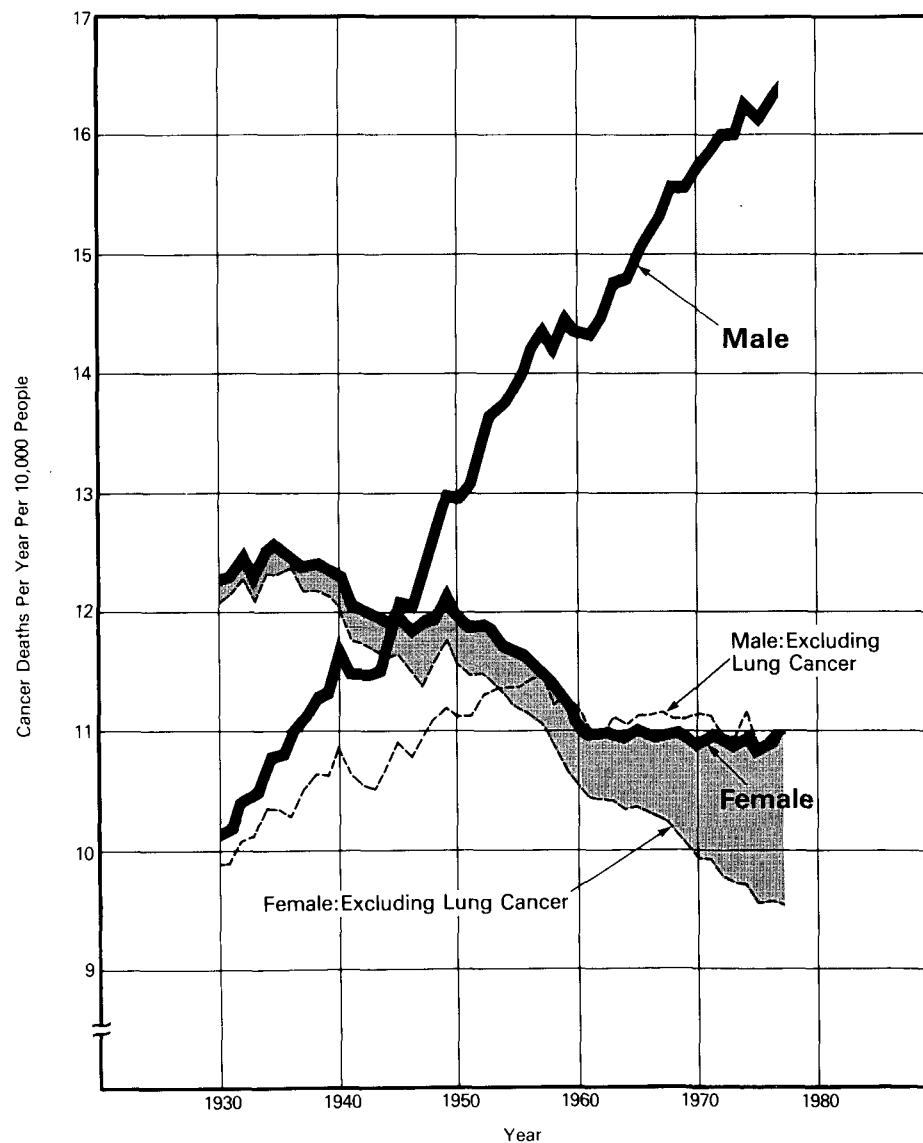

Figure 19. Cancer death rates in the United States.²⁴

In this chapter, we have said that out of 10,000 people who died in 1977, about 2,000 of them died of cancer. But in any group of 10,000 people that you select, the number dying of cancer could be considerably more or less than 2,000.

For example, in the U.S., the cancer death rate for men is now 50% higher than the rate for women. In 1930, women had a higher rate, but their rate has dropped (see Figure 19).

Sometimes the reasons for these different death rates are partially understood, for example, the effect of cigarette smoking on lung cancer. But often the reasons for the differences are not well understood. These differences make it difficult to compare the differences in cancer death rates between people exposed to radiation and people not exposed to radiation.

If 10,000 people are each exposed to 1 rem of radiation, scientists estimate at most 1 additional cancer death. Because so many factors affect the cancer death rate, it is not possible to measure whether the 1 additional cancer death occurred or not. The normal variability in the

number of cancer deaths would be several hundred in a group of 10,000 people.

Even though scientists have gone to great effort to detect radiation effects, they have been unable to identify any effects from a few rems of radiation per year.

Therefore, we can say with certainty that additional cancer and genetic defects caused by radiation doses within legal limits are much less than the normal incidences of these effects. There is only uncertainty in precisely *how small* the effects are. This is the uncertainty scientists talk about. There is almost no uncertainty that the risks from radiation doses within the legal limits are smaller than many other risks we commonly encounter and accept in our lives.²⁵

Still you might ask, "If the legal dose limits have some risk, even a small one, why not have lower limits?" A similar question could be raised about highway speed limits. When the speed limit was lowered to 55 miles per hour, highway fatalities decreased but did not disappear. The only absolutely safe limits would be 0 miles per hour and 0 rems per year. But then we wouldn't get anywhere.

Discussion Questions

There is a risk associated with the radiation dose you will receive in your work as an industrial radiographer. The following questions are intended to be discussed with your instructor and other students.

1. What other risks do you take in your life?
2. How would you compare radiation risk to these other risks?
3. How do you feel about taking this risk in your job?
4. Can you accept the risk from working as an industrial radiographer?
5. What can you do to minimize your risk?

Harmful Effects

Questions

True or False

1. T F It was not discovered that radiation could cause cancer until after the atomic bombs were exploded during World War II.
2. T F Touching or almost touching a radiography source for only a few seconds can cause radiation burns.
3. T F Some radiographers have had to have their fingers amputated because of injury from radiation burns.
4. T F If you act quickly, it is okay to pick up a loose radiography source by hand and place it in the camera.
5. T F Radiation workers will develop a tolerance to radiation exposure.
6. T F Although radiography sources can cause radiation burns on the skin, the injuries from exposure to the sources are never fatal.
7. T F Redness of the affected skin is the first sign of a radiation burn.
8. T F Redness, swelling, and blistering are all symptoms of radiation burns.
9. T F Everyone who receives an over-exposure to radiation will eventually get cancer.
10. T F Any exposure to radiation may increase your risk of getting cancer.

True or False

11. T F It is usually possible to tell whether a cancer was caused by radiation or by some other cause.
12. T F Scientists know that cancer cannot be caused by radiation doses below legal dose limits.
13. T F Because of the radiation exposure they receive, radiographers are much more likely to get cancer than other people.
14. T F Compared to other jobs, radiography is quite hazardous because of the effects of radiation.
15. T F If you receive a radiation dose of 1 rem, your life expectancy will be decreased by almost a year.
16. T F As a radiographer, the risk of getting cancer because of radiation exposure will be one of the larger risks you face in life.
17. T F The genetic effects of radiation are a greater health hazard than the cancer risk.
18. T F Radiation does not cause genetic defects.
19. T F Children born with genetic defects caused by radiation are easily identifiable because the defects are so grotesque.

5

How Do Time, Distance, And Shielding Affect Your Dose?

Time

Distance

Shielding



In the last chapter we learned that any exposure to radiation, even a very small dose, may have some risk. Therefore, you should keep your radiation dose not only below legal limits but as far below those limits as you can reasonably achieve. In this chapter, we will discuss ways to keep your radiation dose at the lowest reasonably achievable level.

There are three basic ways to lower your dose when working with radiography sources:

1. **TIME:** Don't stay near a radiography source or camera any longer than you have to.
2. **DISTANCE:** Stay as far away from the source as you can.
3. **SHIELDING:** Use shielding between yourself and the source.

Time

The *less time* you spend near a radioactive source, the *less radiation dose* you will receive. The way you calculate dose from dose rate and time is:

$$\text{dose} = \text{dose rate} \times \text{time}$$

So, if your survey meter reads 5 mR/hour at some location, you will receive a dose of 5 mrem in 1 hour, 10 mrem in 2 hours, 15 mrem in 3 hours, and so forth. This means the less time you spend at that location, the less dose you will receive.

Let's consider how you can reduce your radiation dose by spending as little time near a source as possible. The pictures in Figure 2 give you some ideas.

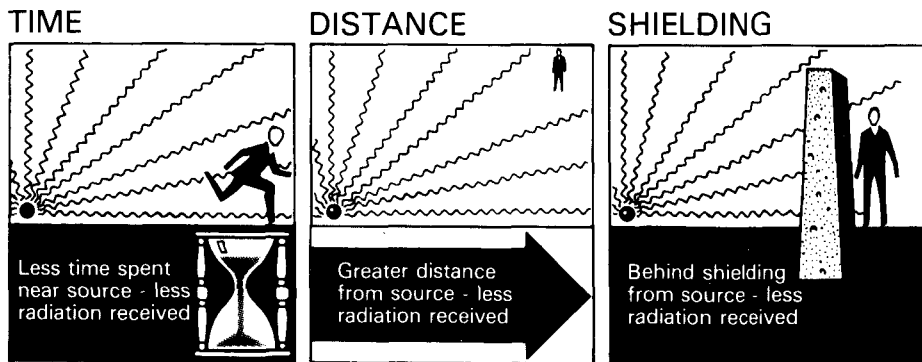

Figure 1. How time, distance, and shielding affect dose.



1) Crank the source rapidly to expose or retract the source.



2) During the time that the source is exposed, stand outside the restricted area.



3) Carry the camera rapidly to its intended location.



4) Don't sit near the camera unnecessarily.

Figure 2. You can reduce radiation exposure by spending less time near a source.

Now, let's work some problems involving *time*.

Problem 1:

Your radiation survey meter reads 100 mR/hr at some point. How much dose would you receive standing at that point in (a) 1 hour, (b) ½ hour, (c) 6 minutes, and (d) 1 minute?

Answer:

Use the formula,
dose = dose rate x time

$$(a) \text{ Dose} = 100 \text{ mR/hr} \times 1 \text{ hr} \\ = 100 \text{ mR or } 100 \text{ mrem}$$

$$(b) \text{ Dose} = 100 \text{ mR/hr} \times \frac{1}{2} \text{ hr} \\ = 50 \text{ mR or } 50 \text{ mrem}$$

(c) It is first necessary to convert minutes into hours.
To do this divide 6 minutes by 60 min/hr:

$$\frac{6 \text{ min}}{60 \text{ min/hr}} = 0.1 \text{ hr}$$

Now:

$$\text{Dose} = 100 \text{ mR/hr} \times 0.1 \text{ hr} \\ = 10 \text{ mR or } 10 \text{ mrem}$$

(d) We do this problem the same as we did problem (c):

$$\text{Dose} = 100 \text{ mR/hr} \times \frac{1 \text{ min}}{60 \text{ min/hr}} \\ = \frac{100}{60} \text{ mR} \\ = 1\frac{2}{3} \text{ mR or } 1\frac{2}{3} \text{ mrem}$$

These values are shown in Figure 3.





If the dose rate = 100 mR/hr...		
Time		Dose
1 Hour		100 mR
½ Hour		50 mR
6 Minutes		10 mR
1 Minute		1 2/3 mR

Figure 3. Effect of time on radiation dose.

You can use calculations such as these to establish boundaries for the restricted area and high radiation area.

Problem 2:

You plan to take four exposures at a field location. You estimate that you can complete these four exposures in less than 1 hour. Each exposure will take 3 minutes. From past measurements you know that at 100 feet from the source the dose rate will be 20 mR/hr. How much dose will a person standing 100 feet from the source receive in any 1 hour?

Answer:

When a problem has many pieces like this, many people can understand the problem more clearly if they draw a diagram such as the one below:

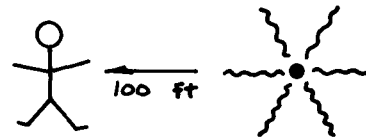

20 mR/hr

4 exposures
3 min each

Now use the formula for dose:

$$\text{dose} = \text{dose rate} \times \text{time} \\ = 20 \text{ mR/hr} \times \frac{4 \text{ exposures} \times 3 \text{ min}}{60 \text{ min/hr}} \\ = \frac{20 \times 4 \times 3}{60} \\ = 4 \text{ mR or } 4 \text{ mrem}$$

So, a person standing at 100 feet from the source during the hour would receive a dose of 4 mrem.

Calculations like this are needed to establish safe working distances. In Chapter 8 you will learn that regulations require you to restrict access to any area where anyone would receive a dose of 2 mrem or more in any 1 hour.

Problem 3:

This problem is to show that the "any one hour" used to calculate the maximum possible dose is a *moving target*. "Any one hour" means *any* 60-minute period. For example, if you make your first exposure at 3:30 p.m. and your second exposure at 4:20 p.m., the dose from each exposure must be added when you calculate the "dose in any one hour." The "one hour" is from 3:30 p.m. to 4:30 p.m. The "one hour" is not 3:00 p.m. to 4:00 p.m. If you are making repeated exposures at this location, you must determine the highest dose that is possible during any 60-minute interval. Consider this example.

You plan to make six exposures at a field location. Each exposure will take 5 minutes. Based on your past experience, you know that it will take you *about* 15 minutes or more setup time between exposures. Your first exposure is at 3:30 p.m. From past measurements you know that at 100 feet from the source the dose rate will be 20 mR/hr. How much dose will a person standing 100 feet from the source receive in any one hour?

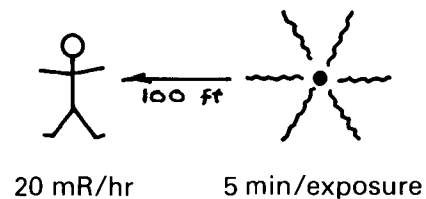
**Answer:**

Each 5-minute exposure will last for $\frac{1}{12}$ of an hour. Therefore, the dose from each exposure will be:

$$\begin{aligned} \text{dose} &= \text{dose rate} \times \text{time} \\ \text{dose} &= 20 \text{ mR/hr} \times \frac{1}{12} \text{ hr} \\ &= 1.67 \text{ mR} \end{aligned}$$

The first "any one hour" starts at 3:30 p.m. and runs to 4:30 p.m. The combined exposure time of 5 minutes plus setup time of 15 minutes is 20 minutes between exposures. You can make 3 exposures in "any one hour."

But wait. Let's consider the maximum possible dose "in any one hour." We said that setup time was *about* 15 minutes. However, we better assume you might work just a little faster and fit 4 exposures (rather than 3) into the "any one hour."

Therefore, the dose to a person standing there for "any one hour" would be:

$$\begin{aligned} \text{dose} &= 1.67 \text{ mR/exposure} \times 4 \text{ exposures} \\ &= 6.7 \text{ mR} \end{aligned}$$

The second "any one hour" will start at 3:50 p.m. and run to 4:50 p.m. Since you will make, at most, 4 exposures during that hour, too, the dose to a person standing at 100 feet from the source will also be 6.7 mR.

In Chapter 8, we will talk about your responsibilities for limiting the radiation dose to a member of the public.

Distance

Increasing your distance from a source will *decrease* the amount of radiation you receive. As radiation travels away from its source it spreads out and becomes less intense. This idea is illustrated in Figure 4. More rays of radiation strike the person nearer the source.

Now let's calculate exactly how much less radiation is received as distance is increased. To do this, Figure 4 is not adequate because the picture is flat; it has no depth. Figure 5 is a more accurate picture. Look at this figure carefully.

The radiation spreads out in straight lines as it moves away from the source. The same rays of radiation that pass through the smallest yellow square pass through the middle yellow square and also the largest yellow square. So, the same amount of radiation passes through each square. Do you see why?

The area of the smallest square is 1 square inch. The area of the middle square is 4 square inches (because $\text{area} = \text{length} \times \text{width}$). The area of the largest square is 9 square inches.

As we move from the smallest square to the middle square, we double the distance from the source, but the area that the radiation spreads into is four times as great. The area of the smallest square is 1 square inch. The area of

the middle square is 4 square inches. Therefore, if we double the distance from the source, the radiation intensity is only one-quarter as great. Its intensity is divided by four because the same number of rays is spread out over an area 4 times as large as before.

As we move from the smallest square to the largest square, we triple the distance, but the radiation spreads out into an area nine times as great ($\text{area} = \text{length} \times \text{width} = 3 \times 3 = 9$). The radiation intensity is divided by nine.

What would happen if we moved from the smallest square to a square four times as far away? The radiation would be spread out over an area of 16 square inches.

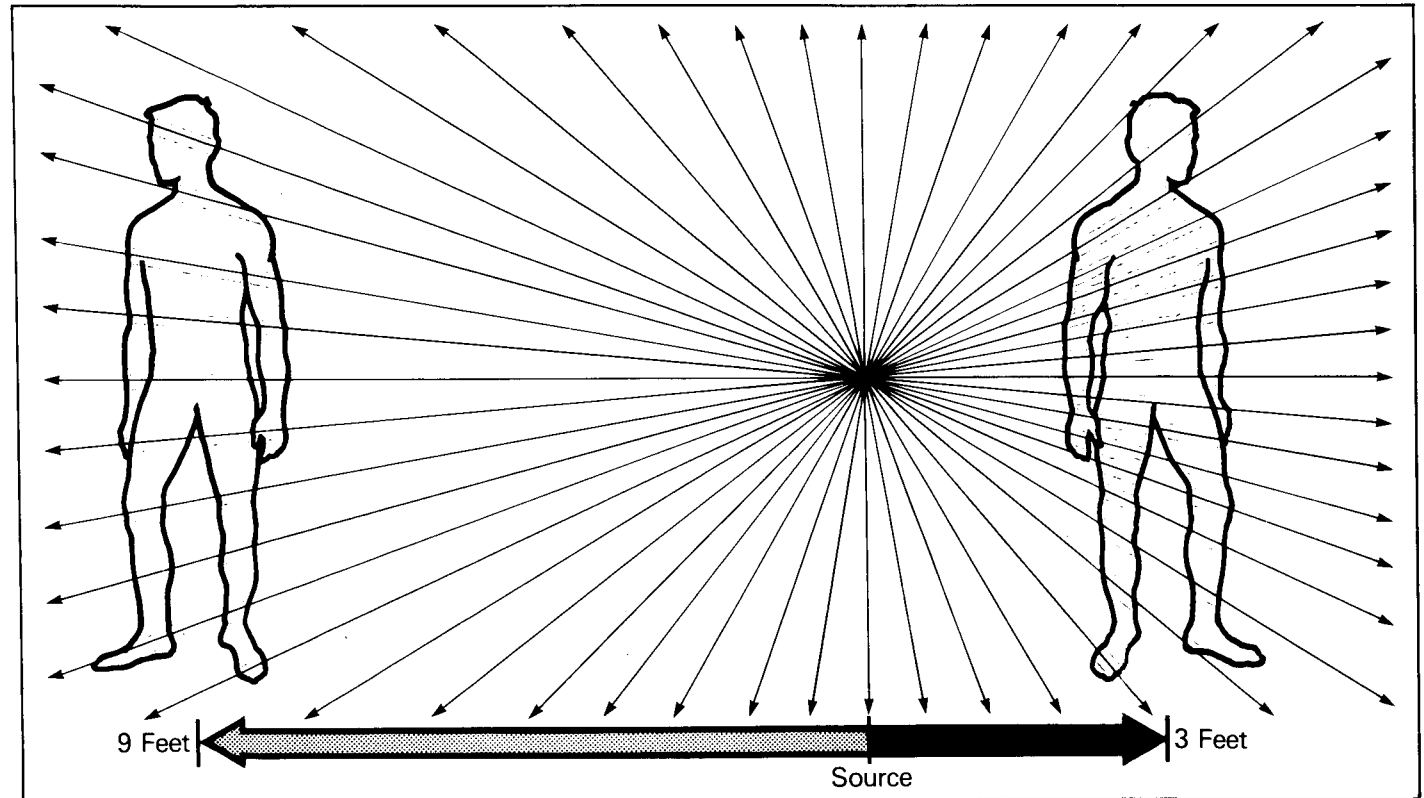

Figure 4. The effect of distance on radiation dose. More rays of radiation (marked with yellow) strike the person nearer the source.

Do you see the relationship? If the distance is two times as great, the intensity is divided by four ($2 \times 2 = 4$). If the distance is three times as great, the radiation intensity is divided by nine ($3 \times 3 = 9$). If the distance is four times as great, the radiation intensity is divided by sixteen ($4 \times 4 = 16$).

The Inverse Square Law

We can write an equation that will tell us the dose rate at any distance from a source if we know the dose rate at some other distance. Look at the diagram in Figure 6 for the inverse square law equation.

The equation to calculate D (the dose we want to know) is:

$$Dr^2 = D_0 r_0^2 = \text{a constant}$$

Or, if we divide both sides of this equation by r^2 ,

$$\frac{Dr^2}{r^2} = D_0 \frac{r_0^2}{r^2}$$

the equation can be written either:

$$D = D_0 \frac{r_0^2}{r^2} \quad \text{or} \quad D = D_0 \left(\frac{r_0}{r} \right)^2$$

This is an important equation, and you should learn it. It is called the **inverse square law**.

Inverse means that one quantity gets larger as the other one gets smaller. As we *increase* distance r from the source, the dose D *decreases*.

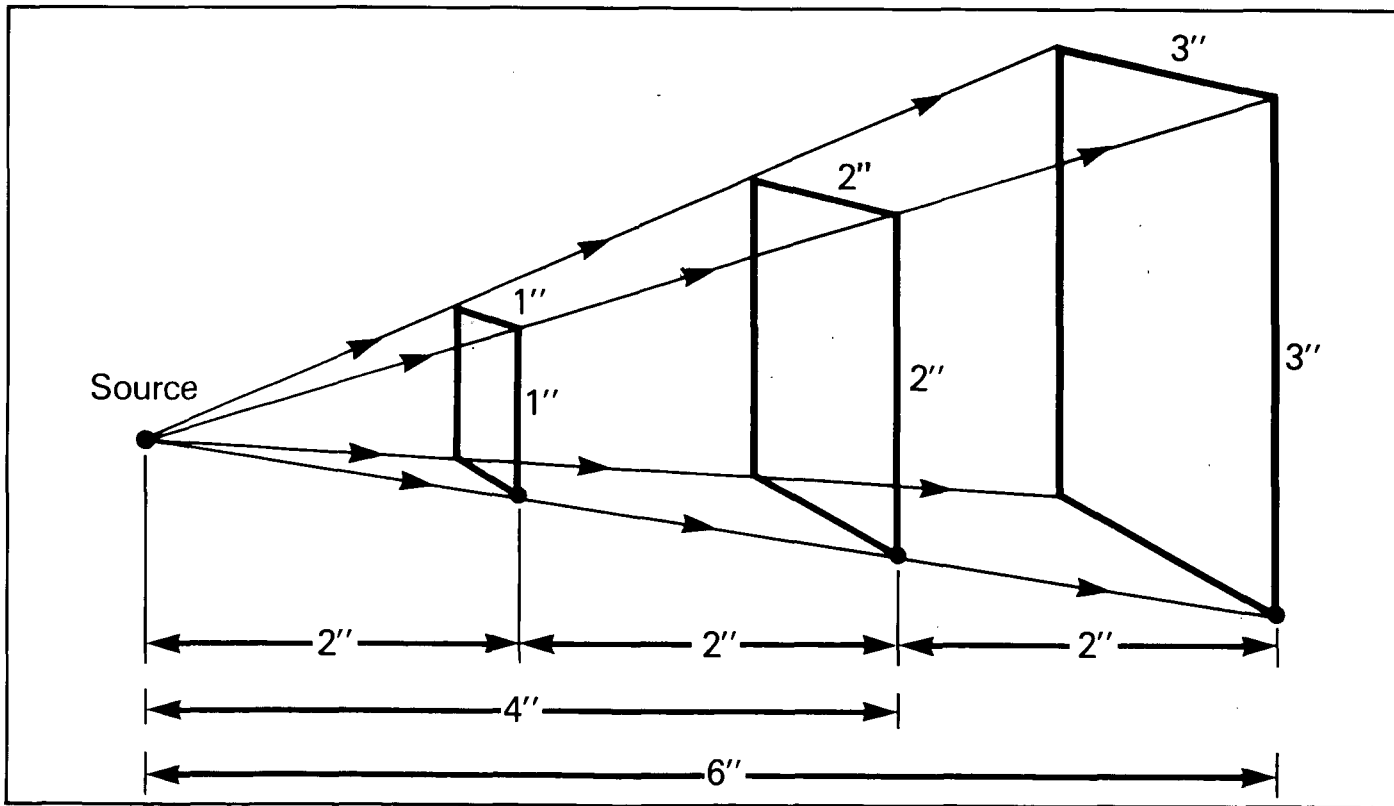

Figure 5. Inverse square law concept.

There is one additional fact that will make this equation much more useful to you. The dose rate at 1 foot from a 1-curie source of iridium-192 is a known value that we can use in the inverse square law equation. The dose rate at 1 foot is also a known value for a 1-curie source of cobalt-60. Those values are given here:

Radioactive material	Dose rate at 1 foot from a 1-curie source
Iridium-192	5.2 R/hr* (or about 5 R/hr)
Cobalt-60	14.0 R/hr

*This value was revised in 1981 based on improved measurements.¹ The older value was 5.9 R/hr at 1 foot.

The iridium-192 value can be rounded off to 5 R/hr to make it an easy number to work with. You should remember these values. Now let's work some problems.

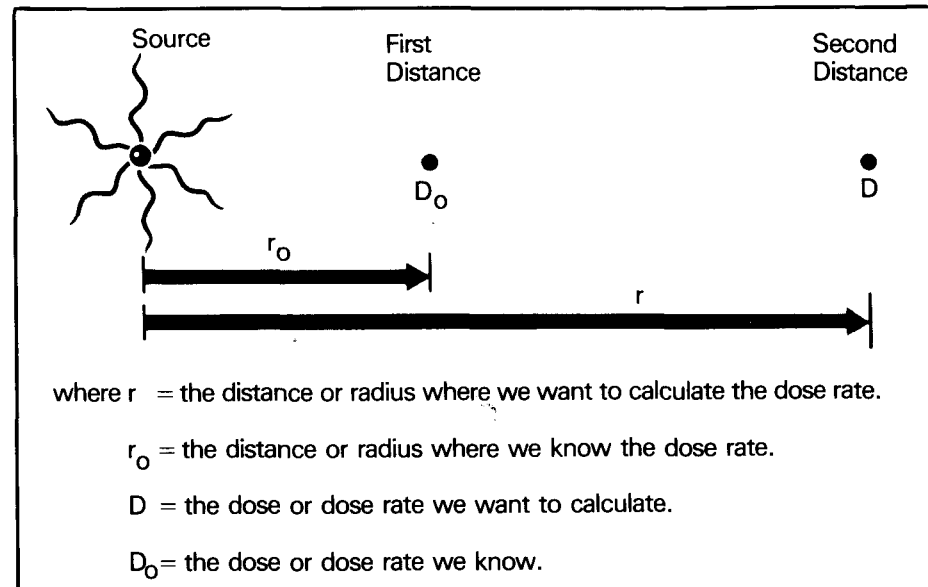

Figure 6. Inverse square law.

Problem 1:

You will be using a 100-curie iridium-192 source. What will the dose rate be at a distance of 100 feet from the source?

Answer:

Use the inverse square law equation.

$$D = D_0 \left(\frac{r_0}{r} \right)^2$$

We know that at 1 foot the dose from 1 curie of an iridium-192 source is 5 R/hr. Therefore:

$$\begin{aligned} D &= 100 \text{ Ci} \times \frac{5 \text{ R/hr}}{1 \text{ Ci}} \times \left(\frac{1 \text{ ft}}{100 \text{ ft}} \right)^2 \\ &= 500 \left(\frac{1}{10,000} \right) \text{ R/hr} \\ &= 0.05 \text{ R/hr or } 50 \text{ mR/hr} \end{aligned}$$

A calculation such as this can help you determine the distance to where you will need to use ropes and signs to keep people out.

Problem 2:

Repeat Problem 1 except calculate the dose rate at 200 feet instead of 100 feet.

Answer:

There are two similar ways to calculate the dose rate, both using the inverse square law equation. In Problem 1 we calculated the dose rate at 100 feet to be 50 mR/hr. We can put that value into the equation. Or we can use the 5 R/hr dose rate at 1 foot. Let's try the 50 mR/hr at 100 feet from Problem 1:

$$\begin{aligned}
 D &= D_0 \left(\frac{r_0}{r} \right)^2 \\
 &= 50 \text{ mR/hr} \left(\frac{100 \text{ ft}}{200 \text{ ft}} \right)^2 \\
 &= 50 \text{ mR/hr} \left(\frac{1}{2} \right)^2 \\
 &= \frac{50 \text{ mR/hr}}{4} \\
 &= 12.5 \text{ mR/hr}
 \end{aligned}$$

Note that in moving from 100 feet to 200 feet the dose rate is divided by 4.

Problem 3:

For the same 100-curie iridium-192 source, at what distance will the dose rate be 100 mR/hr?

Answer:

This time we know D, but not r. Use the same inverse square law equation and dose rate value for iridium-192 at 1 foot.

$$D = D_0 \left(\frac{r_0}{r} \right)^2$$

$$100 \text{ mR/hr} = 100 \text{ Ci} \times 5 \text{ R/hr/Ci} \left(\frac{1 \text{ ft}}{r} \right)^2$$

Look at the equation above. It has both milliroentgens (mR) and roentgens (R). We cannot use both units in the same equation. Either one will work. Let's choose mR.

Therefore:

$$100 \text{ mR/hr} = 100 \text{ Ci} \times 5000 \text{ mR/hr/Ci} \left(\frac{1 \text{ ft}}{r} \right)^2$$

$$100 \text{ mR/hr} = 500,000 \text{ mR/hr} \left(\frac{1 \text{ ft}}{r} \right)^2$$

Multiply both sides of the equation by r^2 and divide both sides by 100 mR/hr:

$$\frac{100 \text{ mR/hr}}{100 \text{ mR/hr}} \times r^2 = \frac{500,000 \text{ mR/hr}}{100 \text{ mR/hr}} \frac{(1 \text{ ft})^2}{r^2} \times r^2$$

Therefore:

$$r^2 = 5000 \text{ ft}^2$$

Take the square root of each side of the equation. A pocket calculator is useful here, but tables of square roots can also be used:

$$r = 70 \text{ ft}$$

Note that we rounded off the value that the calculator gave us. The calculator gave 70.71 We rounded this value off to 70 feet. We could also have rounded it off to 71 feet. We can and should round off numbers such as these. The information we start with is not exact enough to give exact answers. Nor is there any good reason to know the distance more accurately than to the nearest few feet.

Problem 4:

Using a cobalt-60 source, you use your survey meter to measure a dose rate of 5 mR/hr at 50 feet from the source. You want to set up a boundary where the dose rate will be 2 mR/hr. What should the distance from the source to the boundary be?

Answer:

Note that we are not told the source strength, but we do not need it. Note also that we did not have to be told the source was cobalt-60. The key information is that the dose rate is 5 mR/hr at 50 feet. Use the inverse square law:

$$D = D_0 \left(\frac{r_0}{r} \right)^2$$

$$2 \text{ mR/hr} = 5 \text{ mR/hr} \left(\frac{50 \text{ ft}}{r} \right)^2$$

Multiply both sides by r^2 and divide by 2 mR/hr:

$$\frac{2 \text{ mR/hr}}{2 \text{ mR/hr}} \times r^2 = \frac{5 \text{ mR/hr}}{2 \text{ mR/hr}} \frac{(50 \text{ ft})^2}{r^2} \times r^2$$

$$r^2 = 6750 \text{ ft}^2$$

Take the square root of each side:

$$r = 82 \text{ ft}$$

The boundary is at a radius of 82 ft.

Problem 5:

Calculate the dose rate at the surface of the capsule containing 100 curies of iridium-192. (Assume the radius of the capsule is 0.1 inch and also assume all the radiation comes from a point in the center of the capsule.) How long does it take to receive a dose of 1000 rems?

Answer:

Use the inverse square law to calculate the dose rate on the surface. Note that all distances must be expressed in the same units, feet or inches. Let's use inches.

$$D = D_0 \left(\frac{r_0}{r} \right)^2$$

$$D = 100 \text{ Ci} \times 5 \text{ R/hr/Ci} \left(\frac{12 \text{ in}}{0.1 \text{ in}} \right)^2$$

$$= 500 \text{ R/hr} (120)^2$$

$$= 7,200,000 \text{ R/hr}$$

How long does it take to receive a dose of 1000 rems?

$$\text{dose} = \text{dose rate} \times \text{time}$$

Therefore:

$$\text{time} = \frac{\text{dose}}{\text{dose rate}}$$

$$= \frac{1000 \text{ rems}}{7,200,000 \text{ rems/hr}}$$

$$= 0.00014 \text{ hr}$$

Multiply by 60 to convert to minutes and 60 again to convert to seconds:

$$\text{Time} = 0.00014 \text{ hr} \times \frac{60 \text{ min}}{\text{hr}} \times \frac{60 \text{ sec}}{\text{min}}$$

$$= 0.5 \text{ sec}$$

The significance of this time is that touching a radiography source for less than a second will cause a serious radiation burn.

It is often useful to have a graph of the dose rate at various distances from a source. In Figure 7 we have plotted the dose rates at various distances from a 1-curie iridium-192 source. This plot was done on ordinary graph paper. The plot is not useful for most work.

For example, what is the dose rate at 200 feet? At 10 feet? The graph cannot be read accurately, but the graph does make one thing quite clear. As you approach the source, the dose rate increases rapidly.

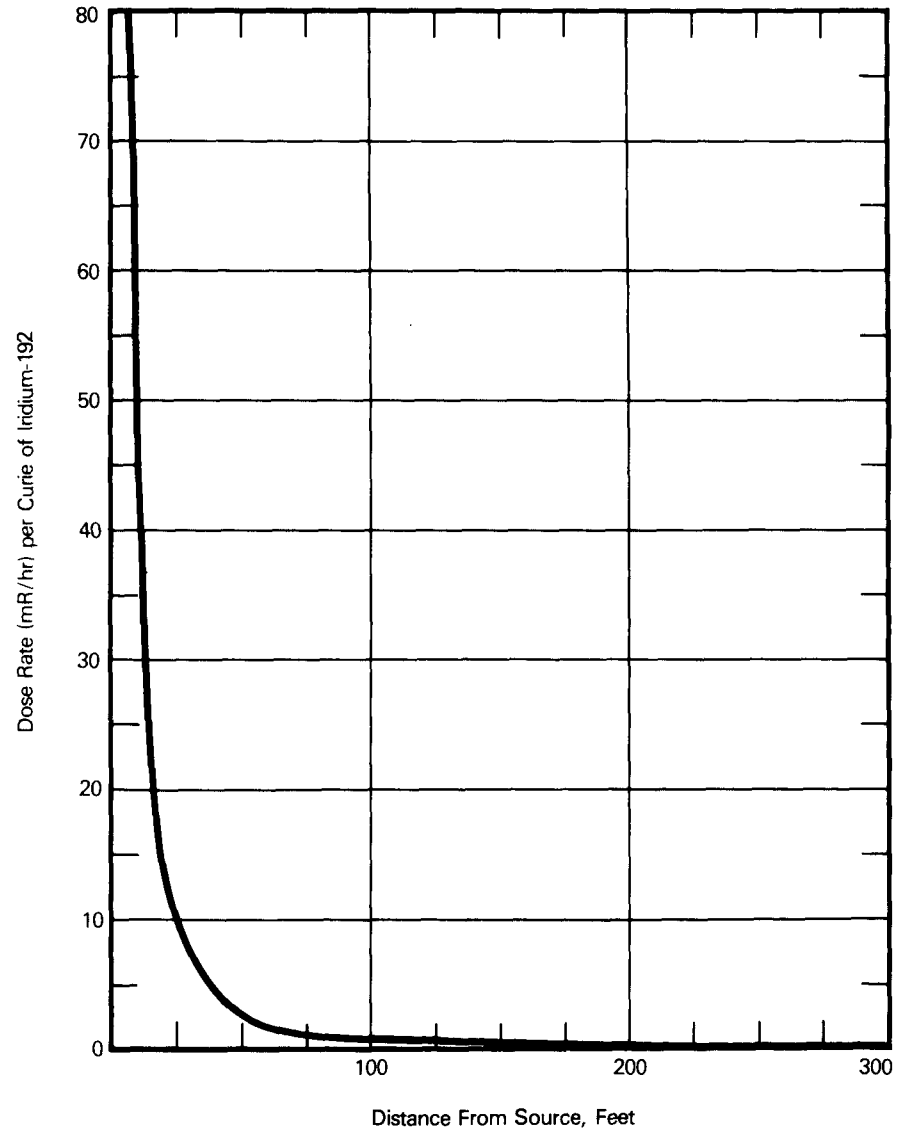
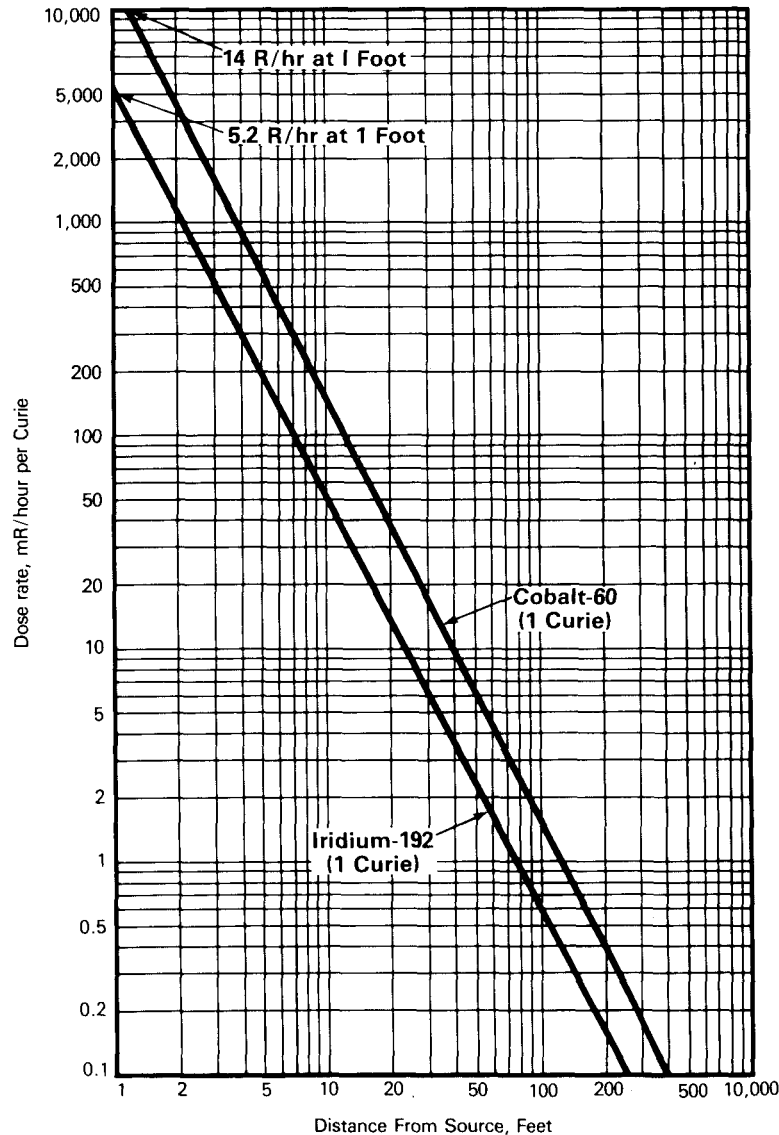

Figure 7. If we plot the dose rate at various distances from a 1-curie iridium-192 source on ordinary graph paper, the plot is not very useful. It cannot be read accurately. Figure 8 shows how to solve this problem — use logarithmic scales.

Time, Distance, and Shielding



In Figure 8 we have plotted the dose rate at various distances from 1-curie iridium-192 and cobalt-60 sources. If you know the strength of your source, you can use the graph in Figure 8 to calculate the dose rate at any distance from the source.

Consider the dose rate at a distance 1 foot away from a 10-curie iridium-192 source. Locate the distance on the bottom scale, read the corresponding dose rate for a 1-curie source (5000 mR/hr), and multiply that dose rate by 10 (the strength of your source in curies). The answer is 50,000 mR/hr or 50 R/hr.

What is the dose rate at a distance of 50 feet from a 100-curie cobalt-60 source?

Locate 50 feet on the bottom scale. Follow the vertical line up to the cobalt-60 curve. Read across to the vertical scale. The dose rate is 6 mR/hr for 1 curie. Multiply by 100 to calculate the actual dose rate for your source. The answer is 600 mR/hr.

Now let's think about some ways that you can make practical use of increased distance to reduce radiation dose. Figure 9 shows how distance can be used to reduce radiation dose.

Figure 8. Dose rate at various distances from 1-curie sources of iridium-192 and cobalt-60.



1) Use a fairly long set of control cables. Lay the control cables out straight.



3) Stand away from a pipeline device during exposures



2) Walk away from the crank during the exposure.

Figure 9. How distance can be used to reduce radiation dose.



4) Don't put the camera in the passenger compartment of your truck.

Shielding

Another way to reduce radiation dose is to place something between you and the source to absorb the radiation. Material placed between you and the source to reduce radiation dose is called **shielding**. In general, the more dense a material is, the more effective it will be as a **shield** for x-rays and gamma rays.

Uranium metal is the most effective shielding material for x-rays and gamma rays. Tungsten is also very good. Lead is good. Steel is fairly good. Concrete is not as effective as these other materials, but it is often used because it is comparatively inexpensive and easy to use in construction. A thick wall of concrete can be just as effective as a much thinner wall of uranium or lead if the concrete wall is thick enough.

Now let's consider some applications of shielding in radiography. Probably the most practical use of shielding in radiography can be achieved by the use of **collimators**. Collimators are small pieces of lead, uranium, or tungsten that surround the source to absorb radiation not directed toward the object being radiographed. The small size of collimators makes them easily portable so they can be carried into the field.

Figure 10 shows several collimators made of tungsten. Collimators are made in various sizes and shapes

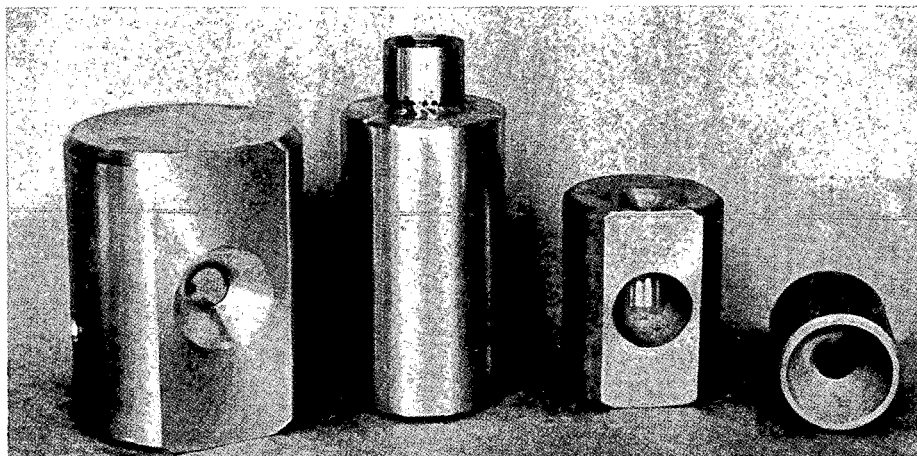

Figure 10. One of the most effective means that you have to reduce the radiation dose to yourself and others is by using collimators such as those shown above.

for different applications. These collimators can achieve dose reductions of about 20 to 10,000 times for iridium-192 and 3 to 10 times for cobalt-60.

Figure 11 shows a lead collimator. The lead is 1 inch thick and reduces the dose by 70 times for iridium-192 and by 4 times for cobalt-60.

Figure 12 shows a collimator made of lead attached directly to a camera. This arrangement avoids having an unshielded source running through the guide tube. The camera shown uses uranium to shield the source when the source is inside the camera. Uranium is weakly radioactive and this is noted on the camera labeling.

The use of a lead collimator and lead bricks in a radiography shot is shown in Figure 13. The collimator is about $\frac{1}{2}$ inch thick and reduces the dose by almost 10 times for iridium-192. A 2-inch lead brick behind the film reduces the dose by about 2,000 times for the radiation beam that has passed through the lead brick. Note how much more effective 2 inches of lead is in comparison to $\frac{1}{2}$ inch. Every time the beam passes through $\frac{1}{2}$ inch of lead, it emerges only about one-tenth as strong as when it entered.

Collimators, of course, have a hole in them so that radiation can strike the film. Generally collimators will have a second hole, too, where the source enters the collimator. The



Figure 11. A lead collimator is placed against an object to be radiographed to shield the radiation that is not directed toward the film.

second hole is quite evident in Figure 10. Because of this second hole, most collimators will have a second beam of radiation. You will have to consider the second beam when you make some of your radiation surveys and when you set up your ropes and signs to keep people away from the radiography area.



Figure 12. If the collimator can be attached directly to the camera (as in this picture), the source will always be at least partially shielded. The source will not travel through an unshielded guide tube.

When objects are radiographed at a permanent facility, thick concrete walls can be built around the room for shielding.

Some of the most massive shielding associated with industrial radiography is used where sources are fabricated and welded into their stainless steel capsules. Figure 14 shows a worker using remote-controlled master-slave manipulators to make sources inside a massively shielded enclosure. The shielding in the walls is concrete

about 6 feet thick. The worker looks through leaded glass 3 feet thick.

Sometimes you will want to know how much material it will take to reduce the radiation dose by one-half. The thickness of a material required to reduce radiation dose by one-half is called the **half-value thickness** or **half-value layer**. Half-value thicknesses for various materials are shown in Figure 15. For example, 1/2 inch of steel will reduce the dose from an iridium source by half.

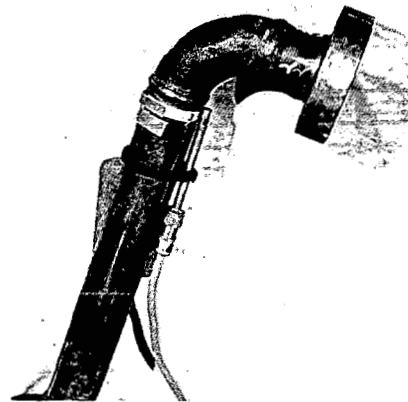

1) Snout of guide tube is attached to the pipe to be radiographed.



2) Lead collimator and film are attached.

Figure 13. These pictures show the use of shielding to reduce radiation exposures to personnel.



3) Lead bricks are placed over the setup. The brick behind the film is especially effective because the collimator does not provide any shielding in the forward direction.

It is possible to use graphs to determine the effectiveness of different thicknesses of shielding materials. Graphs of the **attenuation** (reduction or weakening) of beams of gamma rays in various shielding materials are shown in Figures 16-20. The problems given below can be answered from these graphs.

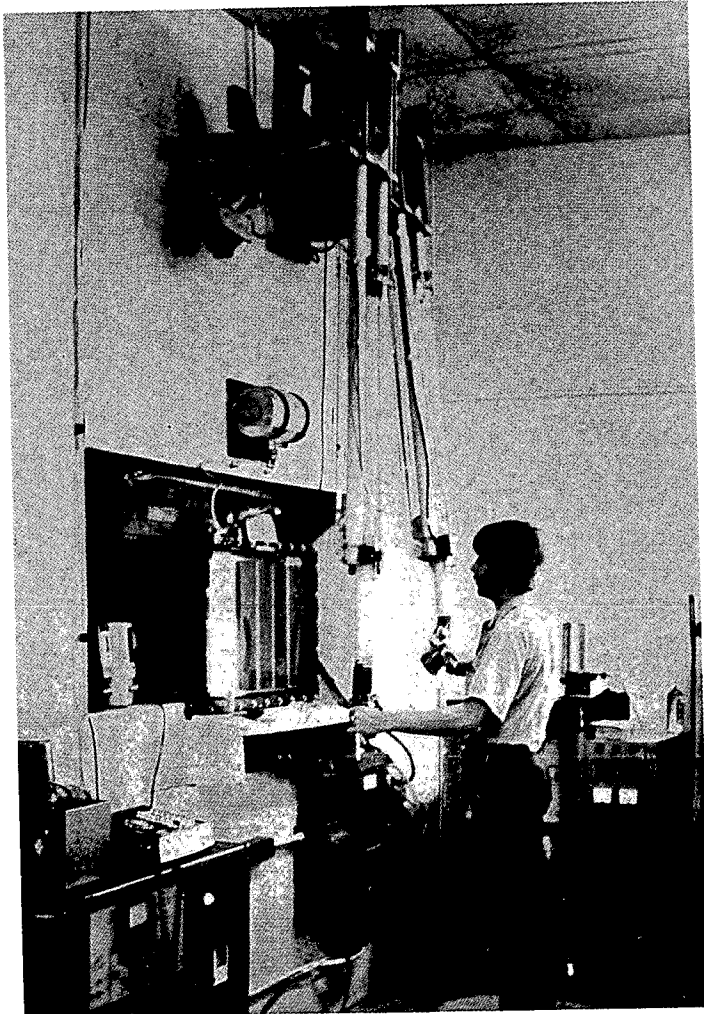

Figure 14. Several feet of heavy concrete shielding and glass containing lead are used to shield enclosures where radiography sources are manufactured. The operator uses master-slave manipulators to weld together the steel capsule containing the radioactive material.

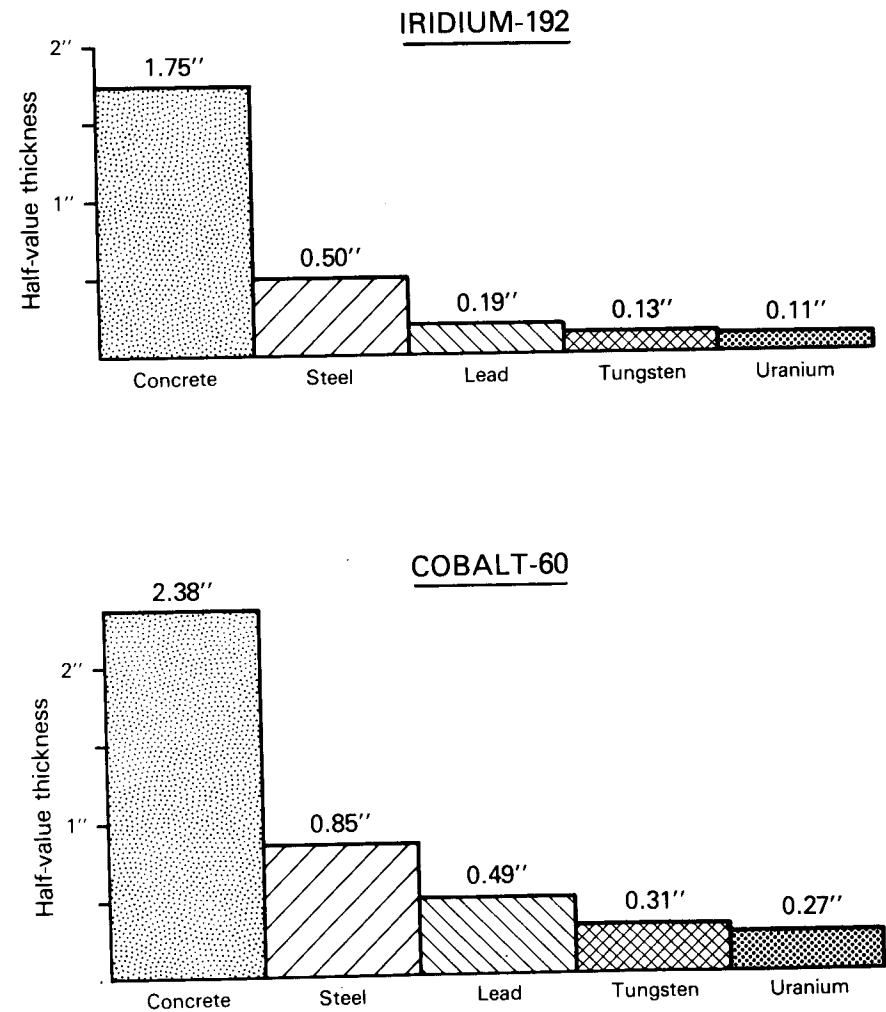

Figure 15. Half-value thicknesses for iridium-192 and cobalt-60.²

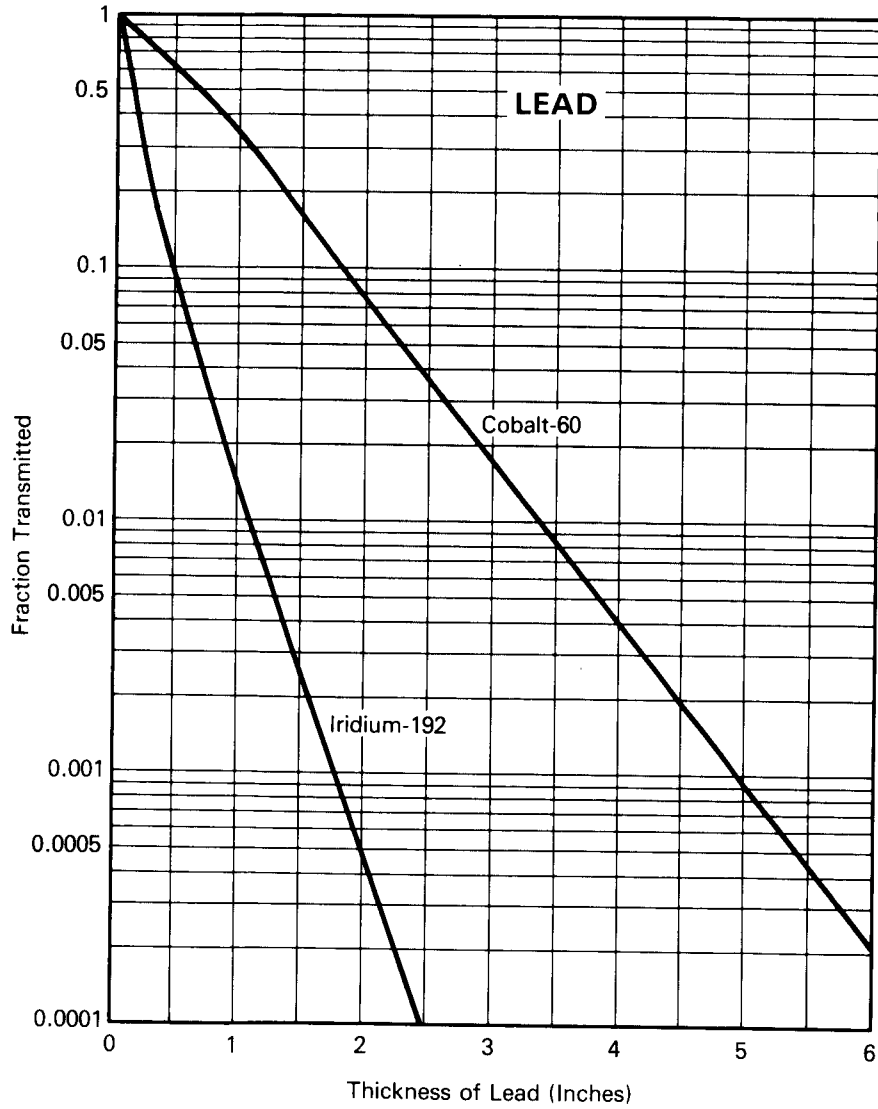

Figure 16. Attenuation of gamma rays in lead.³

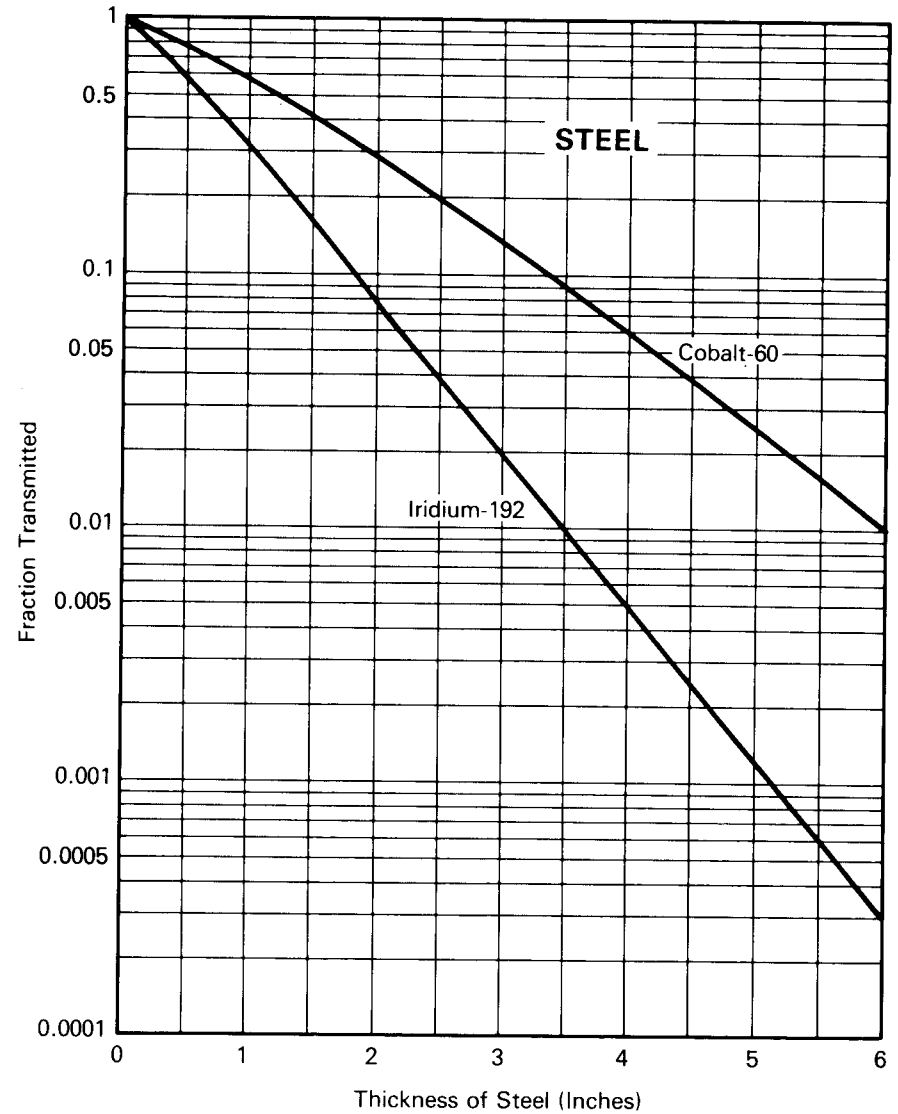

Figure 17. Attenuation of gamma rays in steel.³

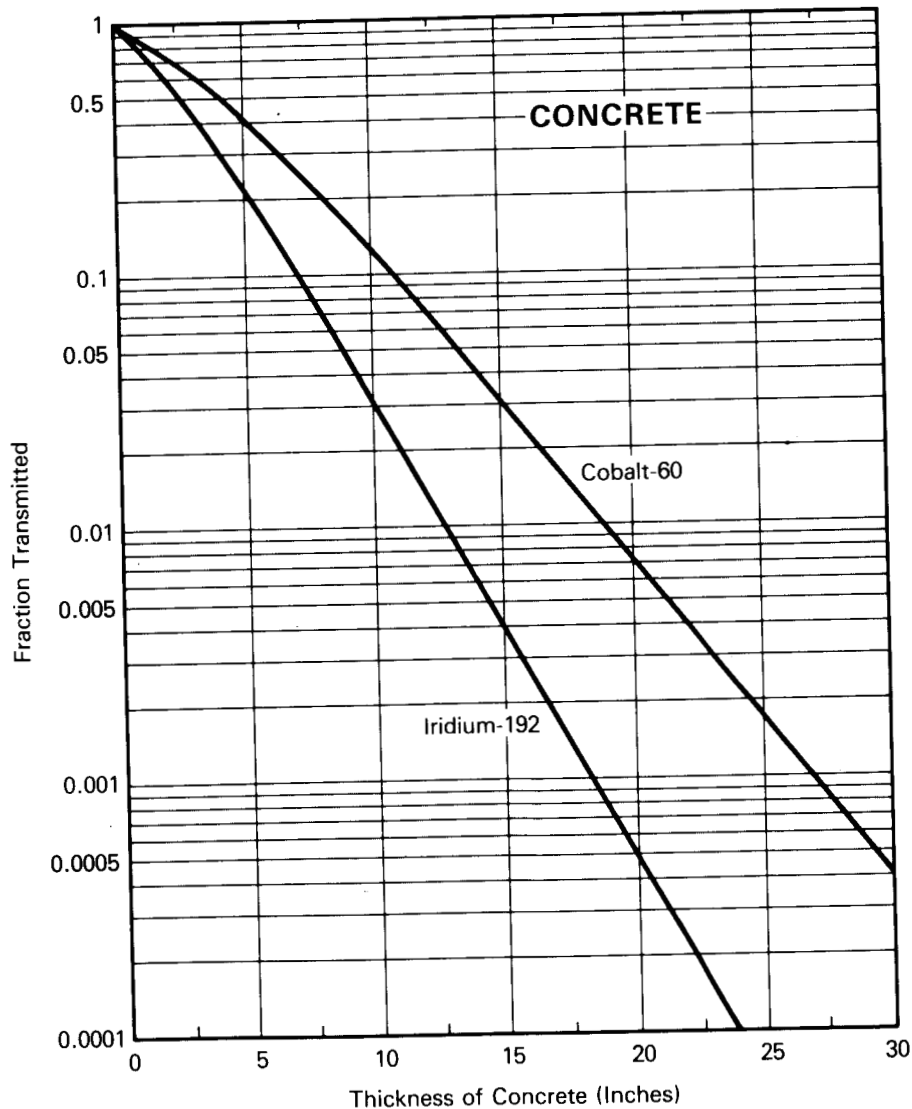

Figure 18. Attenuation of gamma rays in concrete.³

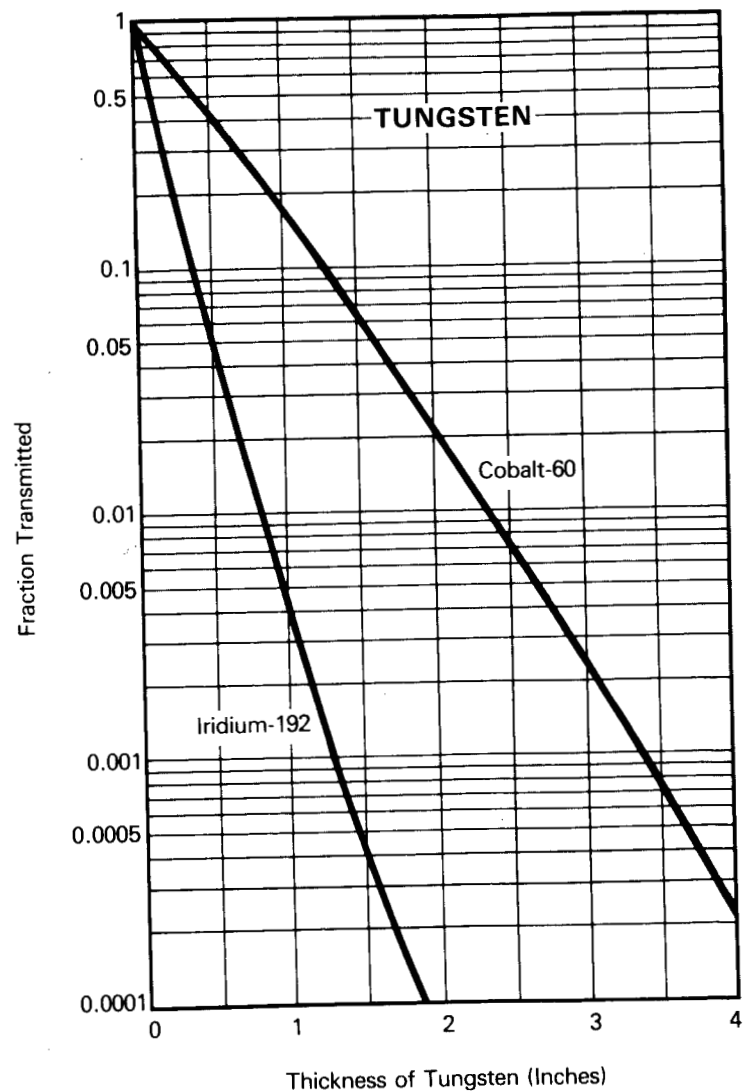

Figure 19. Attenuation of gamma rays in tungsten.³

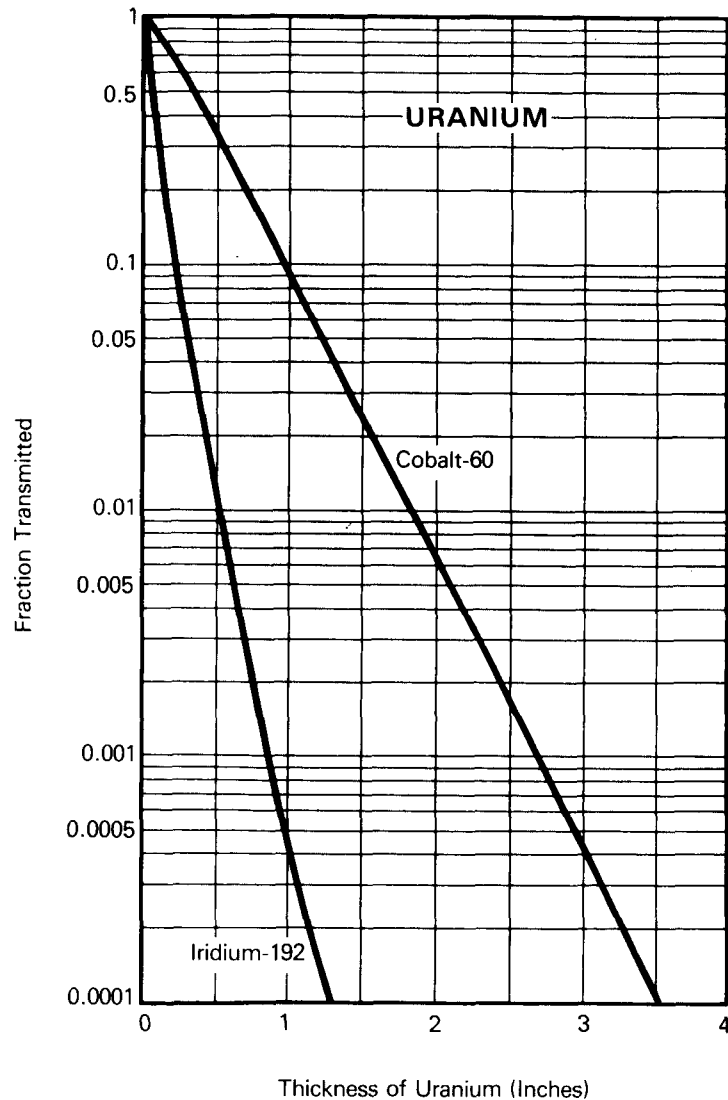

Figure 20. Attenuation of gamma rays in uranium.³

Problem 1:

How thick must a lead collimator be to reduce the dose from an iridium-192 source by a factor of 10? How thick must the lead collimator be to reduce the dose by a factor of 10 if the source is cobalt-60 instead of iridium-192?

Answer:

Look at Figure 16, the graph for attenuation of gamma rays in lead. A factor of 10 reduction means that the fraction of radiation penetrating is 0.1, or one-tenth. Locate this value on the left-hand scale. Read across to the thickness of lead. The answers are about 0.5 inches of lead for iridium-192 and 1.8 inches of lead for cobalt-60.

Note that we need much more lead to shield cobalt-60 than iridium-192 because cobalt-60 gamma rays are more energetic. To achieve the same attenuation, cobalt-60 requires the lead shielding to be four times as thick. This is why cobalt-60 cameras are rarely portable, while iridium-192 cameras can be carried by hand. The portability of the camera is an important reason for the widespread use of iridium-192.

Problem 2:

We have a lead collimator and a uranium collimator each $\frac{1}{2}$ inch in radius. How much better will the uranium collimator be for an iridium-192 source?

Answer:

Use two graphs, Figure 16 for lead and Figure 20 for uranium. Locate a thickness of $\frac{1}{2}$ inch on the bottom scale of each graph. Follow the line upward to the line for iridium-192 on each graph. At the point of intersection, follow a horizontal line over to the left-hand scale. Read the fraction of radiation transmitted.

For lead, 0.095 penetrates. For uranium, 0.012 penetrates. Divide the larger value for lead by the value for uranium:

$$\frac{0.095}{0.012} = \frac{95}{12} = 8$$

Therefore, uranium is about 8 times more effective than lead for shielding iridium-192.

Problem 3:

Calculate the weights of spherical lead and uranium shields that would have to be used around cobalt-60 to achieve a dose reduction of 1000 times. Ignore penetrations in the shield. (Lead weighs 0.41 pounds per cubic inch and uranium weighs 0.68 pounds per cubic inch.)

Answer:

Use the graphs for lead and uranium. From these graphs, you can see that a lead thickness of 4.9 inches is needed and a uranium thickness of 2.7 inches is needed. The volume of a sphere is:

$$V = \frac{4}{3} \pi r^3$$

where r is the radius of the sphere.

Therefore, for lead

$$V = \frac{4}{3} \times 3.14 \times (4.9)^3 = 493 \text{ cu in}$$

For uranium

$$V = \frac{4}{3} \times 3.14 \times (2.7)^3 = 82 \text{ cu in}$$

If we multiply these volumes by the appropriate weight per unit volume, we have for lead:

$$\begin{aligned} \text{Weight} &= 493 \text{ cu in} \times 0.41 \text{ lb/cu in} \\ &= 202 \text{ lb} \end{aligned}$$

For uranium:

$$\begin{aligned} \text{Weight} &= 82 \text{ cu in} \times 0.68 \text{ lb/cu in} \\ &= 56 \text{ lb} \end{aligned}$$

The lead shield is about four times heavier than the uranium shield. The interesting fact about this result is that even though uranium metal is one of the heaviest materials known, it makes the lightest shields. Uranium makes the shielding of least thickness. And the weight of a shield increases proportionally to the cube of the thickness. Pound for pound, uranium is about the best shielding material.

If you are good at working problems and reading graphs like the ones in this chapter, you may find calculations like these useful in doing your work. But it is also possible to rely on past experience to estimate dose rates that will be obtained. Calculations or experience are both equally acceptable depending on what you do best. But, in either case, you should use your survey meter to check that you really do have the dose rates that you think you have.

Group Discussion

Discuss ways that you can make practical use of time, distance, and shielding on your job to reduce your radiation dose.

Questions

1. Your radiation survey meter reads 10 mR/hr. How much dose will be delivered in 1 minute? 15 minutes? 1 hour? 40 hours?
2. You note that your pocket dosimeter has picked up 3 mR after a 5-minute exposure. What was the radiation dose rate?
3. List four situations in which you could use *time* to reduce your radiation exposure in your job.
4. The dose rate at 100 feet from a radiography source is 3 R/hr. What is the dose rate at 20 feet? 45 feet? 1000 feet? 1 foot?
5. You are working with a 50-curie iridium-192 source. What is the dose rate at 100 feet?
6. You are working with a 75-curie cobalt-60 source. What is the dose rate at 50 feet?
7. List four situations in which you could use *distance* to reduce your radiation exposure in your job.
8. NRC regulations state that the radiation dose cannot exceed 2 mR in any 1 hour in an unrestricted area. Assume you are performing radiography 100 feet from an unrestricted area. You are using a 60-curie iridium-192 source and each shot requires a 1.5 minute exposure of the source. How many exposures can be made in 2 hours at this location? (The exposure rate from an iridium-192 source at 1 foot from the source is 5 R per hour per curie.)
9. What is generally the most practical way for a field radiographer to use shielding to reduce dose?
10. With an iridium-192 source, how much dose reduction can be achieved with a 1-inch thick collimator of lead? Of tungsten? Of uranium?
11. The dose rate from a cobalt-60 source with no collimator is 20 mR/hr at a distance of 100 feet. What is the dose rate with a tungsten collimator that is 1 inch thick?
12. Cobalt-60 is used in a fixed facility with concrete walls. The dose rate outside the wall in one spot is 10 mR/hr. How much extra concrete thickness would have to be added to reduce the dose rate to 2 mR/hr?



6

How Do You Detect And Measure Radiation?

Survey Meters Measure Dose Rate

Dosimeters Measure Your Dose

Alarm Systems at Permanent Installations

Testing Sources for Leaks



As a radiographer you will have two types of devices to detect and measure radiation. First, you will use a portable hand-held radiation **survey meter**. By reading the meter dial, you will get a measurement of the radiation *dose rate* at the moment and place where you are. Second, you will have at least two **dosimeters**. Dosimeters are devices that record the total radiation *dose*. Radiation survey meters read *mR/hour*, a dose rate. Dosimeters read *mR*, a dose.

Survey Meters Measure Dose Rate

Survey meters used by radiographers generally use a cylindrical tube filled with gas to detect radiation. The tube is usually inside the survey meter case. But the tube can also be outside the case, connected to the case by an electrical cable.

Figure 1 shows the cross section of a **gas-filled radiation detector**.

Gas-filled tubes are used in two types of survey meters: the **ionization chamber** (or ion chamber) survey meter and the **Geiger-Muller** (or G-M) survey meter.

Both ionization chamber instruments and G-M survey meters are accurate enough for measuring the gamma rays used in gamma radiography. G-M survey meters are most often used because they are rugged and highly sensitive to small amounts of radiation. For

low-energy x-rays (each x-ray has a small amount of energy), G-M survey meters may not be accurate enough. Ion chambers are sometimes more suitable for x-ray radiography.

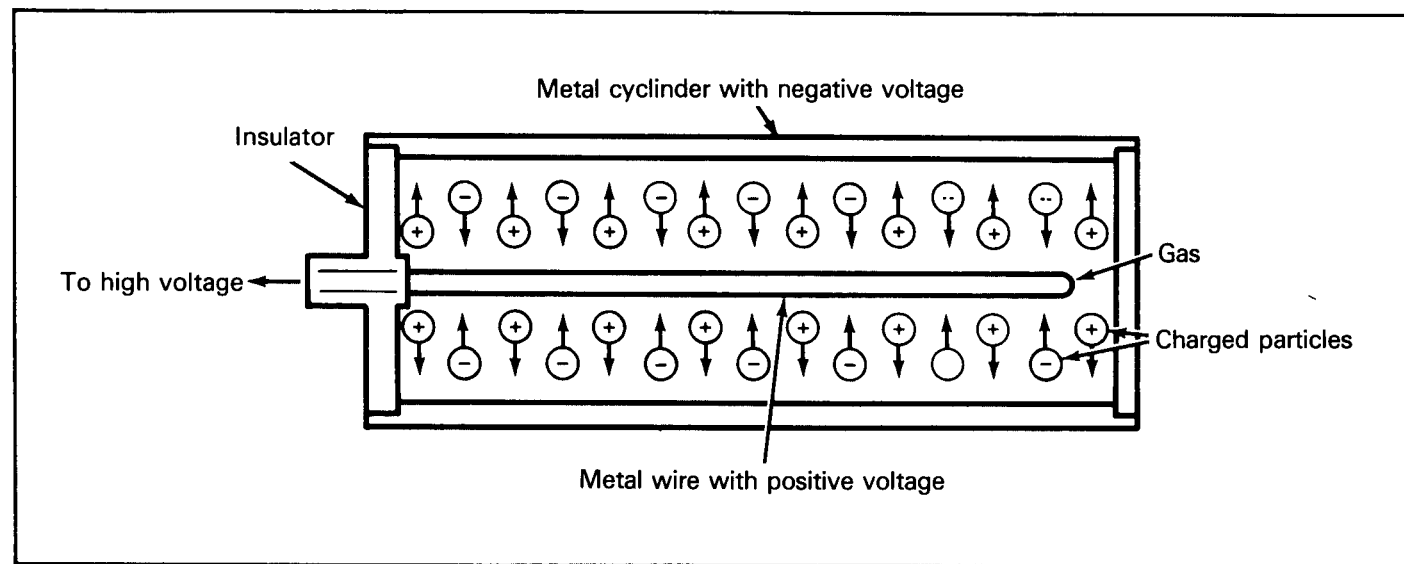

However, certain G-M survey meters are not suitable for radiography. When radiation intensity is high, a few G-M survey meters with old designs will read zero because the pulses of current get so close together that the survey meter does not respond to them. Older G-M survey meters that read zero at high dose rates should not be used. The instruction manual should indicate if the survey meter will fail to respond at high dose rates.

Figure 1. Cross section of a gas-filled radiation detector. Figure 5 in Chapter 2 showed charged particles produced by radiation in gas. The charged particles will be attracted to materials with an opposite charge. Movement of charged particles is an electric current. The electrical circuit of the instrument measures the current. The amount of current is read on the dial of the survey meter.

Reading a Survey Meter

Figure 2 shows a typical G-M survey meter. The scale on the dial reads in mR/hr. The needle is pointing to 0.9. To tell the correct dose rate, look at the position of the range switch. In this case, the range switch is set at x10. This means the dial reading is multiplied by 10. The dose rate is 9 mR/hr. If

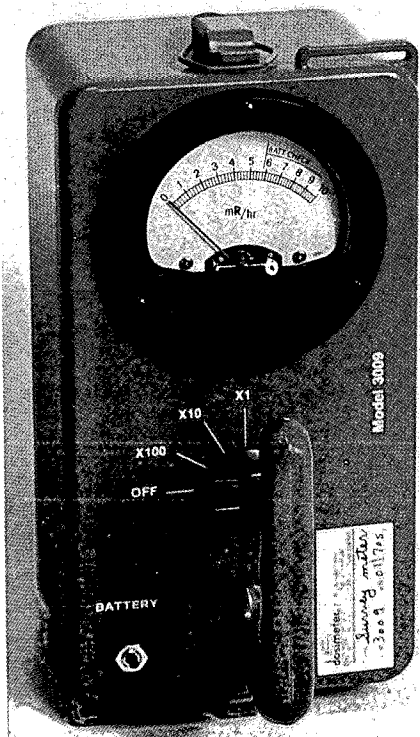

Figure 2. G-M survey meter with 3 ranges: 0-10 mR/hr, 0-100 mR/hr, and 0-1000 mR/hr.

the dose rate would be $0.9 \times 100 = 90$ mR/hr.

Note the **battery-check** button on the lower left. Pushing this button tells whether the batteries are good or not. If the button is pushed, the needle should fall within the "BATT CHECK" bar on the meter dial. If the needle falls to the left of the "BATT CHECK" bar, the batteries should be replaced before the meter is used. Otherwise, the survey meter will not operate properly.

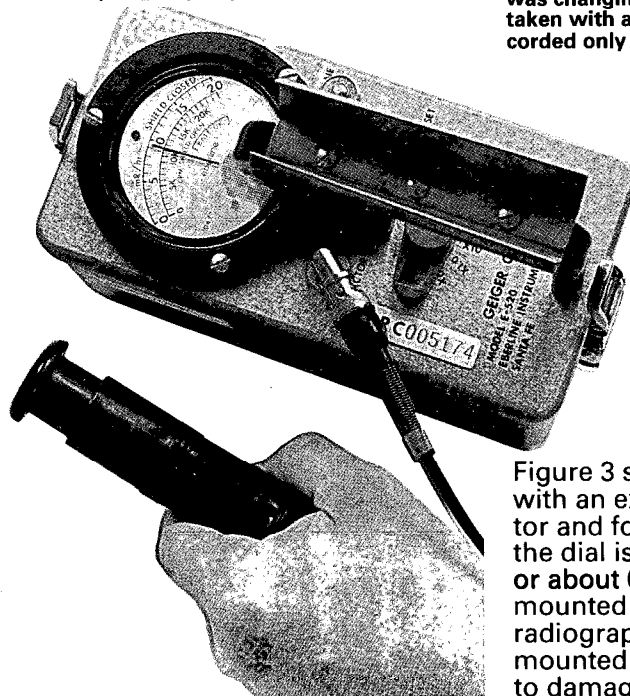

Figure 3. G-M survey meter with 4 ranges and an external detector. The reading on the dial is about 0.1 mR/hr.

EXPOSURE RATEMETER

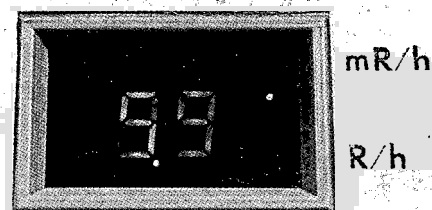

Figure 4. Digital readout on a G-M survey meter. The reading here is not 5.5 mR/hr, or 8.8 mR/hr, or 9.9 mR/hr. The meter reading was changing so rapidly that a photograph taken with a one-second shutter speed recorded only a blur of numbers.

a G-M survey meter. This style of meter is a recent development. In this case, a light shows the range. The range shown is mR/hr.

In general, a needle moving across a dial is considered by human factors engineers to be superior to a digital display where frequent checks on changing conditions are needed.¹⁻³ For example, in making a radiation survey after an exposure, you will want to frequently check

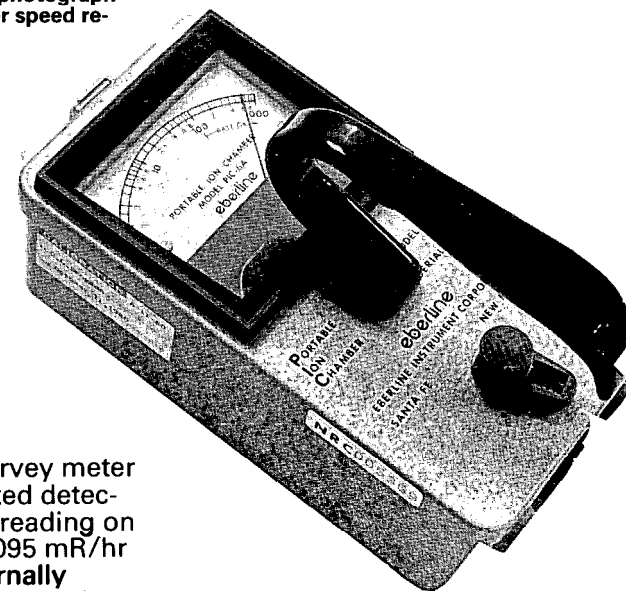

Figure 5. An ion chamber survey meter with a logarithmic scale. The switch is in the battery-check position. The batteries are OK.

your survey meter as you walk toward the camera, survey it, and survey the guide tube. A moving needle is good for this type of measurement.

In doing your work, you will also learn the rate at which the survey meter needle moves as you approach the camera. The speed of needle movement is a good way for you to judge how fast the dose rate is changing. You will also learn roughly where the needle should settle and how quickly it should settle there. The *approximate* dose rate is more important than a *precise* value, because the position of the survey meter relative to the camera will be a little different every time you make a survey. On the other hand, for types of measurements where an operator must record a precise numerical value, digital displays are better than moving needles.

Figure 5 shows an ion chamber survey meter. The meter has a **logarithmic scale**. A logarithmic scale gets more compressed as the dose rate gets higher. We saw scales like this when we discussed radioactive decay in Chapter 3 and shielding in Chapter 5. You operate the ion chamber survey meter in essentially the same way that you operate a G-M survey meter. Ion chambers provide increased accuracy and increased dose range at an increased cost and perhaps a small loss of ruggedness.

Starting Work with an Operable Survey Meter

Never start work without an operable survey meter. This is one of the most important rules in performing radiography. Without an operable survey meter, you cannot be sure that the source is shielded within the camera when it is supposed to be.

The most common cause of survey meter failure is weak batteries. The condition of the batteries should be checked each day when a survey meter is taken for use. Most survey meters have a battery-test position. When the switch is moved to the battery-test position, the meter needle should fall within a marked range on the meter. After radiography has been completed and the survey meter will not be needed for some time, switch it off. This will prolong the life of the batteries.

Fresh batteries typically last for about 100 to 200 hours of operation, but even newly purchased batteries may not always be fresh and may give considerably shorter life. If there is a short circuit in the instrument (possibly caused by dirt, moisture, or damage) or if you accidentally leave the instrument turned on for several days, the batteries can wear out sooner than you expect. You should always have spare batteries available because it is important to have an operable survey meter.

Next, check the meter's response to radiation. Some survey meters have a small radiation source built into the instrument. Moving a switch to the "source-check" position should give a response within a range on the meter specified by the instrument manufacturer.



If the survey meter does not have this feature, place the survey meter against the radiography camera (Figure 6). From previous measurements, you should know about what dose rate to expect. If it does not respond as expected, return the survey meter for maintenance and obtain a properly working instrument. If the meter gives the expected dose rate, move the survey meter away from the camera. The meter needle should fall. With a little experience you will be able to tell if the needle is falling at the expected rate.

Even if your survey meter is operating properly when you start work, it can break during the day. What should you do if your meter starts to behave abnormally in the field and you have no spare? For example, what should you do if your meter starts to give you high readings? Here are two easy ways you can check a high reading using what you learned in Chapter 5.

You can use shielding. If you put the meter behind some shielding material such as 1 inch of steel or 6 inches of concrete, does the reading drop? Is the drop the expected amount? (Refer to the attenuation graphs in Chapter 5.)

Figure 6. Before starting work, check the operation of your survey meter with a radiation source. The surface of your camera provides a radiation source.

You can use distance. Back off to twice the distance. Does the reading drop to about one-quarter of its former value? If so, the meter is responding properly. (Here you are using the inverse square law you learned in Chapter 5.)

If you conclude that the meter is working properly, the high reading may mean the source is exposed. Go back to the crank and try again to retract the source. If this does not produce results, you should follow your company's emergency procedures.

If the meter is broken, you must stop work until you get a replacement. Retract the source and stay away from the camera. Check your pocket dosimeter to make sure you have not been exposed.

Manufacturers of survey meters have succeeded in making them quite rugged, but they can still be broken by rough handling. Wires inside the case can come loose, the G-M tube can break, the battery connections can come off, and the meter mechanism itself can break. You should handle your survey meter gently. You should never throw it into a truck or use it as a hammer.

Water entering the case will cause a survey meter to fail by causing a short circuit or battery failure. Salt or other chemicals can corrode the

electronic circuits and cause the survey meter to fail. Cases are generally made to be watertight, but a bent or cracked case may not keep water out. Damaged cases should be repaired or replaced.

Making a Radiation Survey

The most important **radiation survey** you will make is the survey after an exposure. This survey is to make sure the source has returned to its fully shielded position in the camera.

The following description of this survey is a general description of basic survey technique. Your survey may vary somewhat based on your company's operating procedures and the specific work conditions.

After returning the source to the camera, look at the survey meter. Note the needle position. Is it about where it should be? Approach the guide tube and camera. Is the needle rising at about the expected rate? Move the survey meter along the guide tube. Is the needle position about right?

Survey the camera. The survey of the front of the camera is very important because a source that is almost, but not completely, retracted can have a thin beam of radiation coming out the front.

Place the survey meter against the camera surface at a place where you know what reading to expect. Is the needle position about right?

Now secure the source in its shielded position by pushing the plunger or turning the locking ring.

If you get unexpected readings, something is wrong. It could be an exposed source or a malfunctioning survey meter. At this point you will have to analyze the situation to determine what is wrong. You will probably want very much to believe that the survey meter is wrong. Resist that temptation. *Assume the source is exposed until you understand what the problem is.*

Another important survey you will have to make is the survey to make sure your restricted area boundaries are properly set. A survey is usually conducted during your first exposure. You have already set up



signs and ropes based either on calculations like those in Chapter 5 or on your previous experience with similar situations.

Carefully note your setup. Note where beams of radiation could occur. If you are using a collimator, in which directions will there be unshielded beams? Is there any intervening shielding (such as pipes and concrete walls) to affect your readings?

Based on your observations of the situation, make measurements of the dose rates at enough points on the boundary of the restricted area to be sure you have set it up properly.

Repeat these measurements during later exposures any time you have changed your setup in a way that might change the dose rate at the restricted area boundary.

Calibration

Survey meters used by radiographers must be calibrated at least every 3 months. Every survey meter should have a label showing the last calibration date. The **calibration** requires a source of radiation whose dose rate at various distances is known. The survey meter

Figure 7. A survey at the front of the camera can detect a thin beam of radiation.

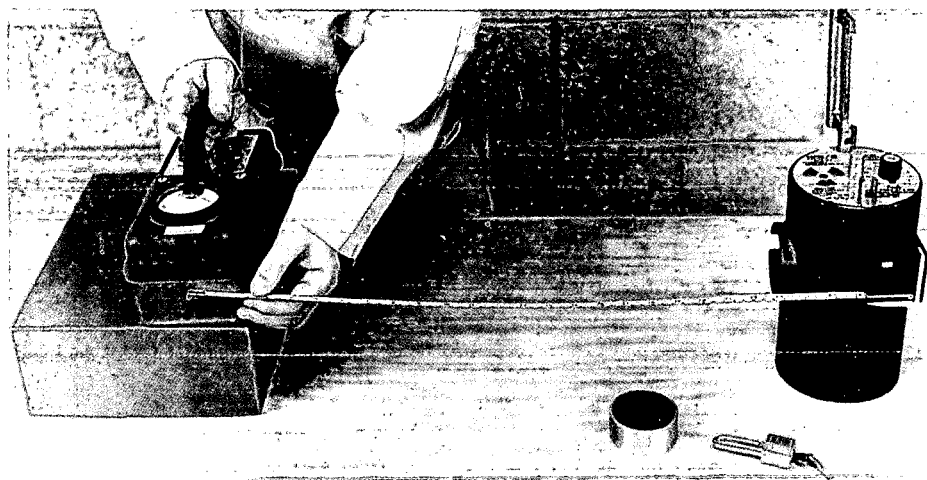

Figure 8. Calibration of a survey meter. The technician carefully measures the distance from the calibration source, contained in a shielded container on the right, to the survey meter on the left. He will know the dose rate at the survey meter location. He will adjust the survey meter until it reads correctly. Note that there is a label located near the top of the dial for making a record of the calibration date.

is placed at a point where the dose rate is known, as shown in Figure 8. An adjustment is made inside the survey meter to produce the desired reading on the instrument.

Most instruments used today have several ranges, and each range is calibrated independently of the other ranges. The usual procedure is to calibrate the instrument at two points on each range. These points should be separated by about 50%

of the full scale reading. For example, one point might be at 25% of full scale and the other point at 75% of full scale.

This calibration should be performed by someone who has been trained to do it.

Dosimeters Measure Your Dose

In addition to the radiation survey meter, which can measure dose rate continuously, you are required to carry two devices to measure the radiation dose you have received. The two devices are (1) a self-reading **pocket dosimeter** and (2) either a **film badge** or a **thermo-luminescent dosimeter (TLD)**.

The pocket dosimeter provides an on-the-spot measurement of dose at any time you want to read it. The film badge or TLD must be processed by your employer or an outside contractor.

Pocket dosimeters, film badges, and TLDs determine what dose you have already received. While these dosimeters measure dose, they do not replace the survey meter. These dosimeters do not give you any warning that the *dose rate* is high. Survey meters tell *how fast* the dose is being delivered so that you can protect yourself if the dose rate is high.

Pocket Dosimeters

A **pocket dosimeter** is basically an air-filled ion chamber. A cross section of a self-reading pocket dosimeter is shown in Figure 9. A fine quartz fiber is attached to a charging electrode. A charger is used to place an electric charge (electrons) on the electrode. The quartz fiber is free to move except where it is attached to the electrode. When the dosimeter is charged, the fiber has the same charge as the wire shown in the figure. The fiber is repelled from the wire because electrons repel each other.

If the dosimeter is exposed to ionizing radiation, the ions created will neutralize the charge on the fiber and wire. As the charge is neutralized, the force repelling the fiber and wire will decrease, and the fiber will move toward the wire.

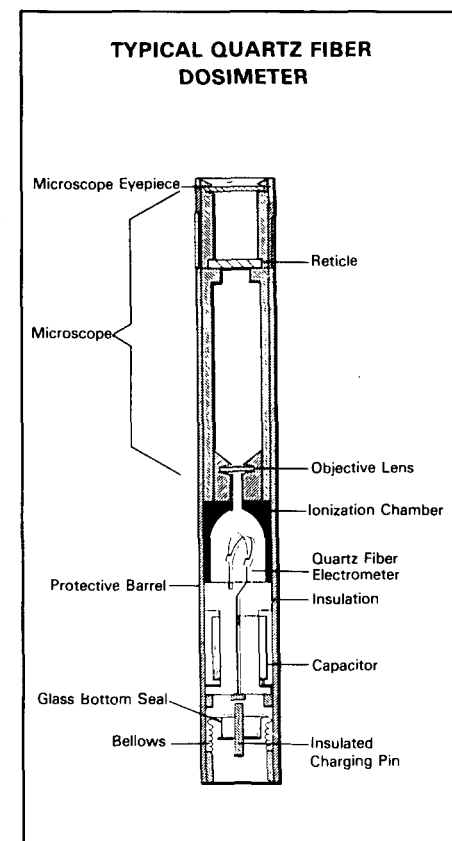

Figure 9. Cross section of a self-reading pocket dosimeter.

When you look through one end of the dosimeter, you see the image of the quartz fiber. The image is projected on a scale that is divided into segments you can read by looking into the eyepiece. The scales usually have divisions at each 10 or 20 mR (as shown in Figure 10). When the dosimeter is fully charged before use, the image of the fiber is made to rest at the "0" position on the scale. The dosimeter used by radiographers must have a full-scale reading of at least 200 mR.

While pocket dosimeters are quite rugged, they can be damaged by being dropped or struck by a hard object. Even if there is no damage, such shock may cause the dosimeter needle to go off scale.

All pocket dosimeters will lose electric charge by leakage even if no radiation is present. If a dosimeter is working properly, this natural leakage will be so small that it will not affect the dose recorded over a working day. If a dosimeter becomes dirty or damaged mechanically, a dosimeter might lose charge rapidly. Such loss of charge will produce false high readings of dose on the dosimeter.

Here's a list of procedures that you should follow when using self-reading pocket dosimeters.

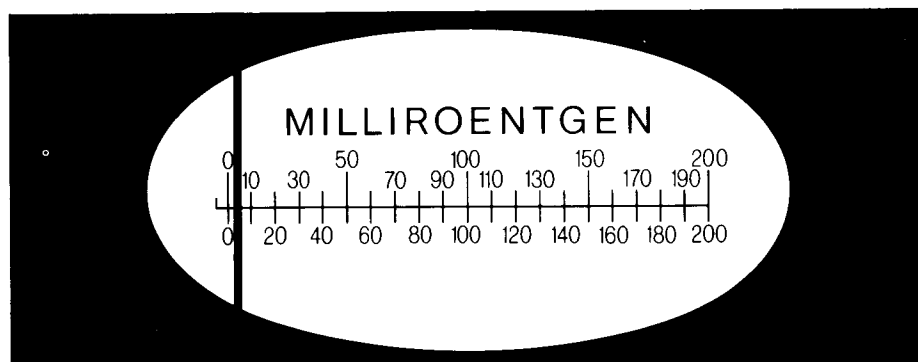

a) Dosimeter fully charged. The quartz fiber rests near "0" on the scale.

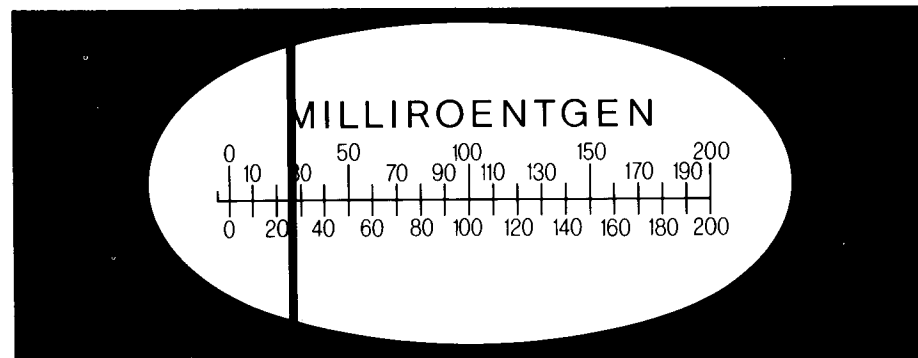

b) Dosimeter exposed to radiation. The reading is 26 mR.

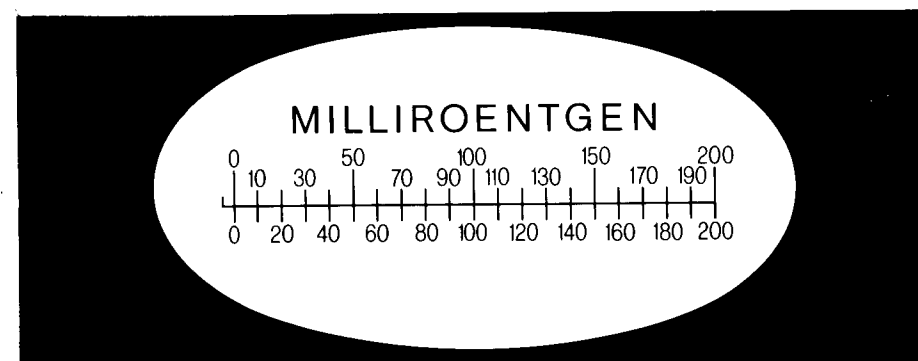

c) Fully discharged dosimeter. The fiber is off the scale.

Figure 10. Image viewed in self-reading pocket dosimeter.

1. The dosimeter should be charged at the start of work. Record the initial reading.
2. Clip your dosimeter firmly to your clothing. Always wear it while doing radiography.
3. Read your dosimeter periodically during radiography. A high reading can mean that something is going wrong. Record your pocket dosimeter reading at the end of work.
4. If you drop your dosimeter or suspect you might have damaged it in some other way, check the reading to see if it appears normal.
5. If your dosimeter reads off-scale, notify your company RSO and have your film badge or TLD processed. Stop work until the RSO determines that there is no hazard.

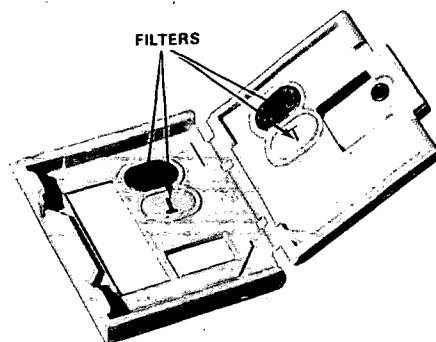

Figure 11. The inside of a film badge without the film. The "filters" are used to tell how penetrating the radiation was.

inside of a typical badge. The metal absorbers or filters tell how penetrating the radiation was and, therefore, whether the exposure was caused by high-energy or low-energy gamma rays. From this information, the company processing the film badge can calculate the correct dose.

The film badge readings form the basis of your permanent dose record. The badge must be worn at all times while you are working. If your pocket dosimeter goes off scale, only your film badge will tell the dose you received.

Film badges are rugged, but they can be damaged by light, heat, and moisture. If the paper covering the film is torn or punctured, the film will be ruined by exposure to light. Film can also be damaged if it is heated over about 130°F. Leaving a

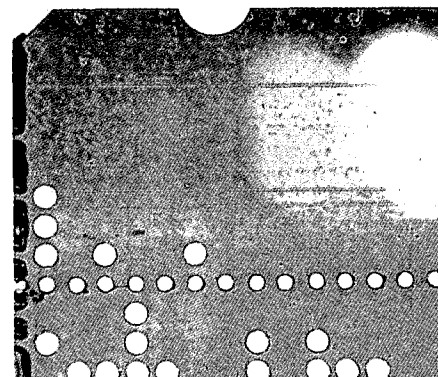
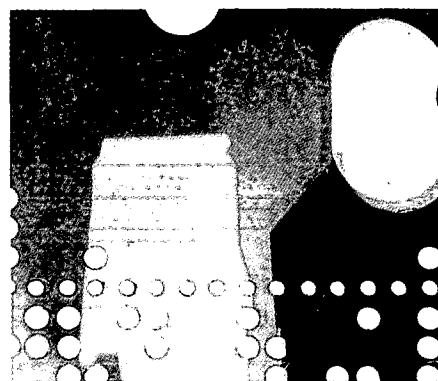

Figure 12. Looking at an exposed film from a badge can tell a lot about how an exposure happened. The film on the top shows a clip, telling that the exposure came from the back. The film on the bottom shows the direction the radiation came from. In case of an accident, the film can help find out what happened.

film badge in a closed automobile on a hot summer day will produce fogging of the film so that an estimate of radiation exposure is impossible. Submerging a film badge in water or laundering it will also ruin the film.

TLDs

TLDs (thermoluminescent dosimeters) are similar to film badges in appearance and can be used by radiographers in place of film badges. Figure 13 shows a TLD badge. TLDs contain crystalline materials that store energy deposited by radiation. The energy deposited can be measured by heating the dosimeter afterwards and measuring the energy released as light. A special TLD reader measures the amount of light emitted. The light emitted by the dosimeter is a measure of the radiation dose.

You should follow this list of recommendations when using a film badge or TLD badge.

1. Clip your badge firmly to your clothing (between your waist and neck), and always wear it while doing radiography.
2. Do not expose the badge to high temperature or water.
3. If you lose or damage your badge, stop work. Submit a damaged badge to your employer and get a new one. Replace a lost badge.
4. Routine processing of badges is done on a regular schedule. Know the schedule and have your badge available for processing.

Film Badges

The **film badge** is a dosimeter containing a piece of film similar to the film used in making radiographs. Ionizing radiation darkens the film — the darker the film, the higher the dose. The dose on the film is read with a **densitometer**.

To produce the proper response and allow the processor to interpret the response correctly, the film must be held in a specially designed badge. Figure 11 shows the

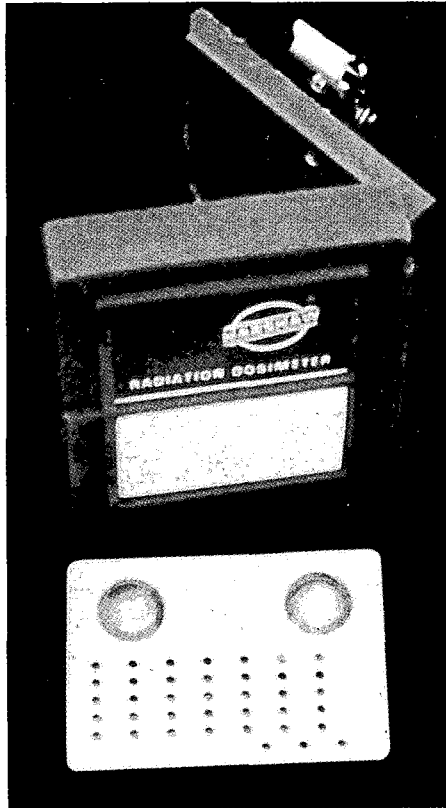

Figure 13. A TLD badge is shown on the left. A closeup of the TLD chip is shown on the right.

Audible-Alarm Dosimeters

Audible-alarm dosimeters are small instruments that you can wear and that will sound an alarm if high dose rates are encountered. Potentially, they can save you from a radiation exposure if your survey



meter fails to alert you to an exposed source. Use of these dosimeters is optional, that is, they are not required.

Use of these devices by industrial radiographers has not been particularly successful, although a few companies and a few radiographers favor their use. Some users found the instruments too fragile. Figure 14 shows how dropping ruined the ceramic speaker on one

audible-alarm dosimeter, and Figure 15 shows how dropping broke a neon bulb in another audible-alarm dosimeter. In addition to dropping, these instruments can also be damaged by water and exposure to salt sprays from the ocean.

Noise levels from the instruments are sometimes too loud and annoying and other times not loud enough to be heard over other noises in the vicinity.

Nevertheless, audible-alarm dosimeters can be a valuable aid to you if you handle them carefully, use them under suitable conditions, and do not try to use them as a substitute for your survey meter.

Alarm Systems at Permanent Installations

If the radiography company has a permanent installation or **radiography cell** for performing radiography, regulations require that a special alarm system be installed (unless the source retracts automatically upon attempted entry).^{*} The alarm system, often called a **gamma alarm**, must have a warning light that is activated by radiation. Therefore, a radiation detector must be installed so that an exposed source can be detected. The warning light must operate whenever the source is exposed.

^{*}10 CFR Section 34.29, "Permanent Radiographic Installations."

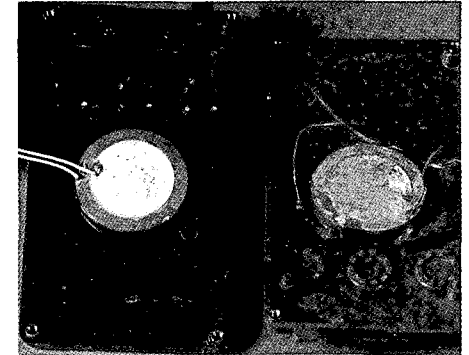

Figure 14. The audible-alarm dosimeter on the right has a ceramic speaker that was broken when dropped. The audible-alarm dosimeter on the left shows the speaker intact.

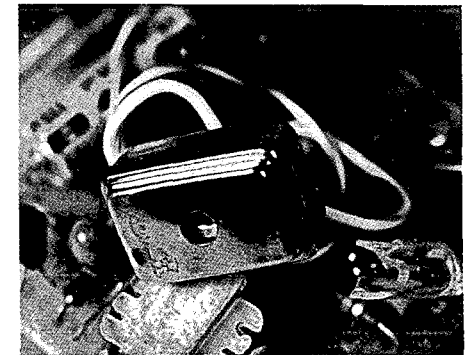

Figure 15. A neon bulb used for voltage regulation in this audible-alarm dosimeter has broken because it was dropped.

The gamma alarm is also required to sound an alarm if someone enters the cell while the source is exposed. An automatic switch on a door or an electric eye in a maze entrance can be used to activate the audible alarm.

Figure 16 shows a gamma alarm. The radiation detector is on the top right side of the case. A light bulb in the dome on top lights when the dose rate exceeds a certain set point. The gamma alarm has been set to alarm at 12 mR/hr, as can be seen by looking at the dark needle on the dial and the range selector.

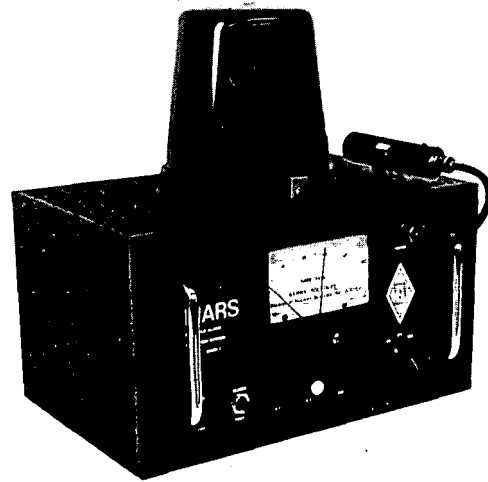

Figure 16. A gamma alarm for a permanent radiographic installation. Radiation activates the light on top. If anyone enters the area while the radiography source is exposed, an alarm will sound.

Testing Sources for Leaks

Radiography sources may not be used unless they have been tested for leaks within the previous 6 months.* A leaking source could spread radioactive materials outside the camera where the radiation would not be shielded.

Source manufacturers test sources for leaks before they are sent to radiographers: A manufacturer's certification that a source has been tested for leaks is shown in the upper righthand corner of Figure 6 in Chapter 3 (the decay curve for an iridium-192 source). This certification gives the date the manufacturer tested the source for leaks.

The first step in making a leak test is to use a piece of cloth to pick up any loose radioactive material that may be present. Figure 17 shows a radiographer wiping the external surfaces of a storage container containing a radiography source with a cotton swab. In Figure 18, the radiographer rubs another cotton swab in the source chamber tube.



Figure 17. A radiographer checks a radiography source in a storage container for radioactive contamination. He uses a cotton swab to wipe the external surfaces.

The radiographer will then survey the swab with a survey meter to make sure the swab is not highly contaminated. If there is a reading on the survey meter, the radiographer should follow company procedures and contact the radiation safety officer.

If the survey meter does not detect any radiation, the radiographer will send or give the swab to someone who has been specially trained to make a leak-test measurement. The leak-test measurement can be performed only by people specifically

trained to do so. A special radiation detection instrument and special procedures are also needed.

In Figure 19, a specially trained person uses a radiation detection instrument to measure any radioactive material that has leaked out of the source capsule and been picked up by the cotton swabs. If the person finds radioactive contamination on the swab in excess of 0.005 microcuries, the equipment must be withdrawn from use and decontaminated. A report of the leaking source must be filed with the NRC.*

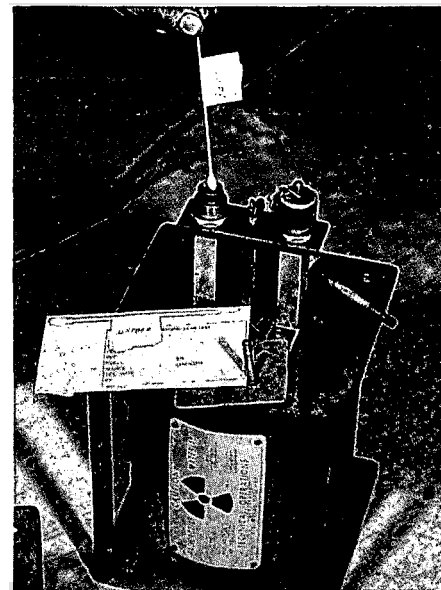

Figure 18. Here the radiographer uses another swab to wipe the inside of the source chamber.

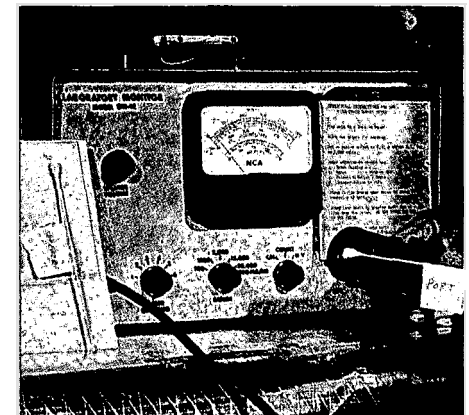

Figure 19. A specially trained person places the cotton swabs against the detector of a radiation detection instrument. If the source is leaking radioactive material, the instrument will detect radiation from the cotton swab.

*As required by NRC regulations in 10 CFR Section 34.25(b).

*As required by NRC regulations in 10 CFR Section 34.25(b).

Questions

1. What are the measured exposure rates based on the following survey instrument readings?

(a) _____

(c) _____

(b) _____

(d) _____

a.

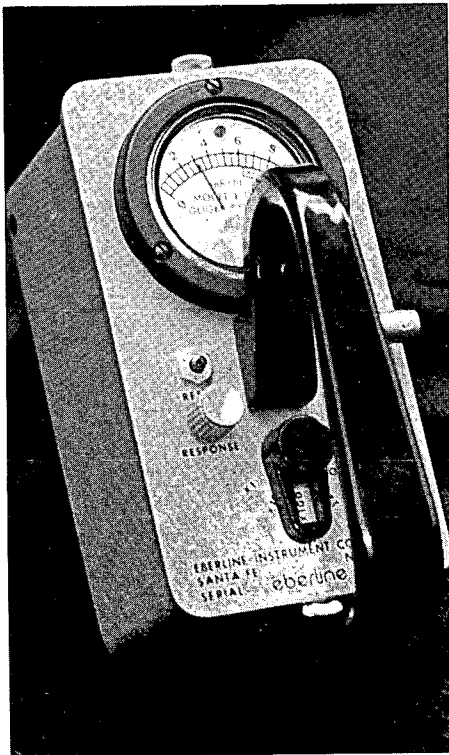

b.



c.



d.

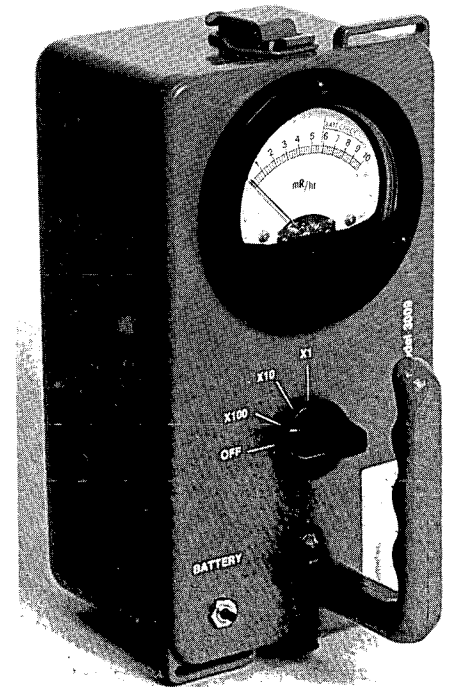

Questions (cont.)

2. What are the exposures as recorded on the pocket dosimeters pictured below?

(a) _____

(c) _____

(b) _____

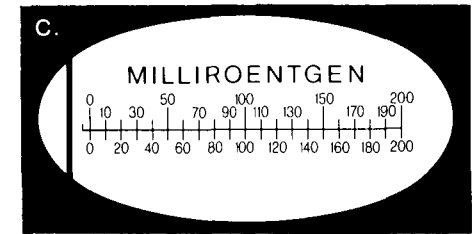
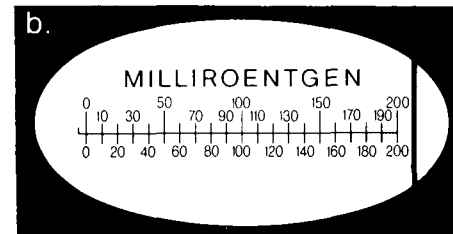
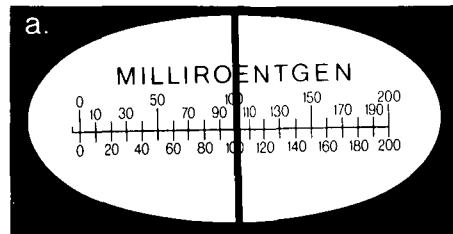

3. What types of dosimetry must be worn by a radiographer on the job?

4. Select the best answer:

While performing radiography, you note that your pocket dosimeter reads off scale. What should you do?

- a. Recharge your dosimeter and continue working.
- b. Complete your work and record the fact in your dosimeter log.

- c. Follow your employer's procedures, and have your film badge or TLD sent out for immediate processing.
- d. Perform a radiation survey to make sure that radiation levels are what you expect.

e. Both c. and d.

5. Select the best answer:

What is the most important thing you can do to avoid an overexposure to radiation?

- a. Always wear the personnel dosimetry provided.
- b. Always make proper radiation surveys.

- c. Request that an alarming dosimeter be provided for use.
- d. Keep a daily log of pocket dosimeter readings.

Questions (cont.)

6. Select the best answer:

Which of the following are the proper steps to take in making a survey after an exposure?

a. Advance toward the camera; survey the guide tube; survey the front of the camera; survey sides and back of the camera.

b. Advance toward the back side of the camera; survey the back and sides while behind the camera; survey the front and guide tube connection; survey the guide tube.

c. Advance toward the tip of the guide tube; survey the guide tube and the front of the camera; reach over the camera and survey the back.

d. Any order or sequence of steps is permissible as long as the radiation level remains low as the radiographer approaches the camera.

7. Select the best answer:

If you arrive at a job and find that your survey meter is not operating properly, what should you do?

a. Complete the job quickly while keeping a close check on your pocket dosimeter.

b. Use past experience to judge where the restricted area boundary should be and complete the job.

c. Send an assistant to obtain a new instrument while you complete the first exposure.

d. Go get a properly operating survey meter.

8. After each radiography exposure, you must make a radiation survey. What is the major purpose for doing this survey?

9. From the time a camera is removed from storage for use on a job through the time the job is completed, what radiation surveys should you make?

10. What is the reason for using a self-reading pocket dosimeter on the job? How frequently must the dosimeter reading be recorded on paper?

7

How Do Radiography Cameras Work?

Types of Cameras

Daily Maintenance

Quarterly Maintenance



A gamma **radiography camera** is basically a shielded container for a radioactive source that emits gamma radiation. The camera has a means for changing the source from being fully shielded to being nonshielded. This lets us use the gamma rays being emitted by the source to expose film.

Types of Cameras

The source may be exposed by pushing it out of the camera on the end of a cable to make radiographs. This is called a **crank-out camera**.

The source may be moved slightly within the camera to be in front of a hole in the shielding, or a piece of shielding may be moved from in front of the source. This is called a **beam-type camera**.

A clear plastic demonstration model of a portable crank-out camera is shown in Figure 1. The source is in the center. The black circle represents a uranium shield. A real uranium shield would be solid without a large space in the center. The tube that passes through the shield is called the **S-tube**. It is shaped like the letter "S." It is shaped like this so that gamma rays from the source cannot pass straight out of the shield without passing through the shielding material. Gamma rays travel in straight lines and cannot curve around the bend in the S.

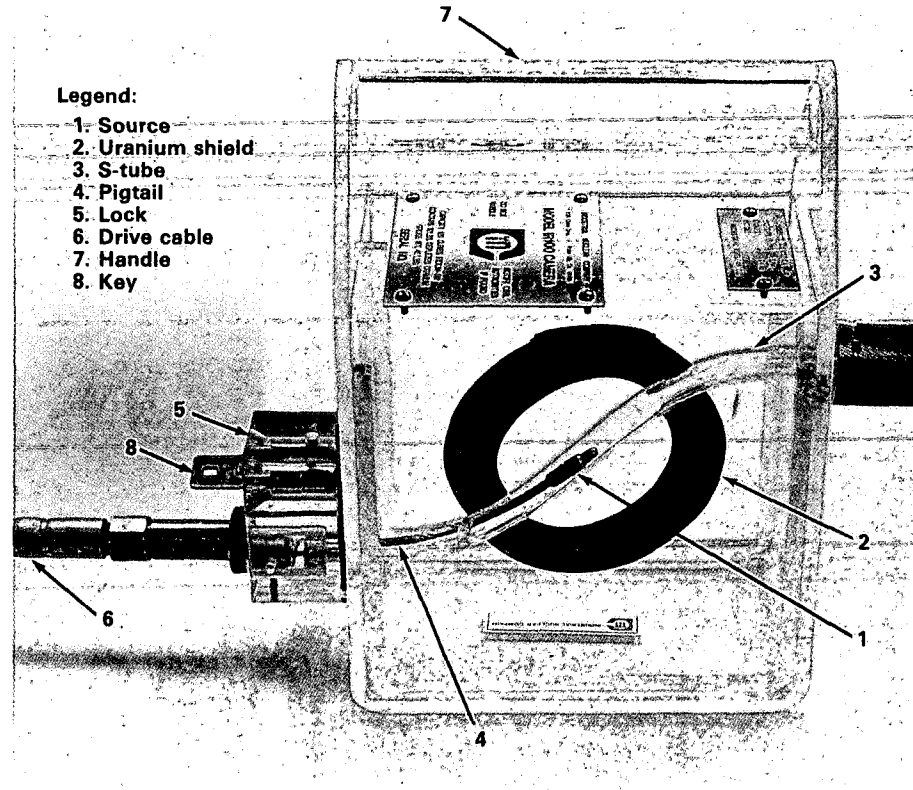

Figure 1. Demonstration model of a portable crank-out camera for iridium-192.

The lock is shown on the left-hand side. When the camera is locked, the source cannot be pushed out. The **drive cable** or **control cable** is connected on the left. The drive cable will push the source out the front of the camera. A source **guide tube** will be attached to the front.

The source will be pushed into the guide tube and guided to the place where the radiographer wants it to be to make the radiograph. Figure 2 shows the drive cable with a crank and the source guide tube that the radiographer will attach to the camera.

The camera shown in Figure 1 is portable, weighs about 45 pounds, and has a capacity of 120 curies of iridium-192. It is designed to be hand-carried by one person. This portability and the ability to operate without electricity are great advantages in many industrial applications.

Using uranium as the shielding material greatly reduces the camera's size and weight and increases its portability. Some cameras use lead for shielding, but lead is less effective as a shield and increases the size and weight of the camera. As we discussed in Chapter 5, pound for pound, uranium is a much better shielding material than lead.

Cameras that have a distance of less than 4 inches from the source to any outside surface (8 inches minimum diameter) are not allowed to have a dose rate at 6 inches from the camera surface that exceeds 50 mR/hr. Most portable cameras are of this type. Cameras that are larger are limited to a dose rate of 200 mR/hr at the surface and 10 mR/hr at 3 feet from the camera surface.*

*10 CFR Section 34.21, "Limits or levels of radiation for radiographic exposure devices and storage containers."



Figure 2. A portable crank-out camera, drive cable, source guide tube, and survey meter.

When cobalt-60 is used, the cameras are not usually portable, but their principle of operation is very much the same. Cobalt cameras are too heavy to be carried by one person because cobalt-60 requires much more shielding than iridium-192. Figure 3 shows a camera designed for cobalt-60. Cameras that are on wheels and can be pushed like this one are called **mobile**. If the camera cannot be moved (except perhaps with a crane or fork lift), it is called **fixed**.

Figure 4 is a sketch of a **beam-type camera**. In this case, turning a control knob rotates the source and part of the shielding to move the source in front of an unshielded opening. A beam of radiation then emerges from the opening through a thin protective cover.

Figure 5 shows a photograph of a beam-type camera. Cameras like this are often called **pipeline cameras** or **pipeliners** because they are often used to inspect welds in pipelines. This camera can be operated either by the knob in front or by attaching a drive cable with a crank to the handle as shown in Figure 6.

Figure 7 shows a beam-type camera that operates with a vacuum. A vacuum hose is being connected to the camera. The vacuum will pull the source out in front of an opening in the shield. When the vacuum is released, a spring will return the source to its shielded position.

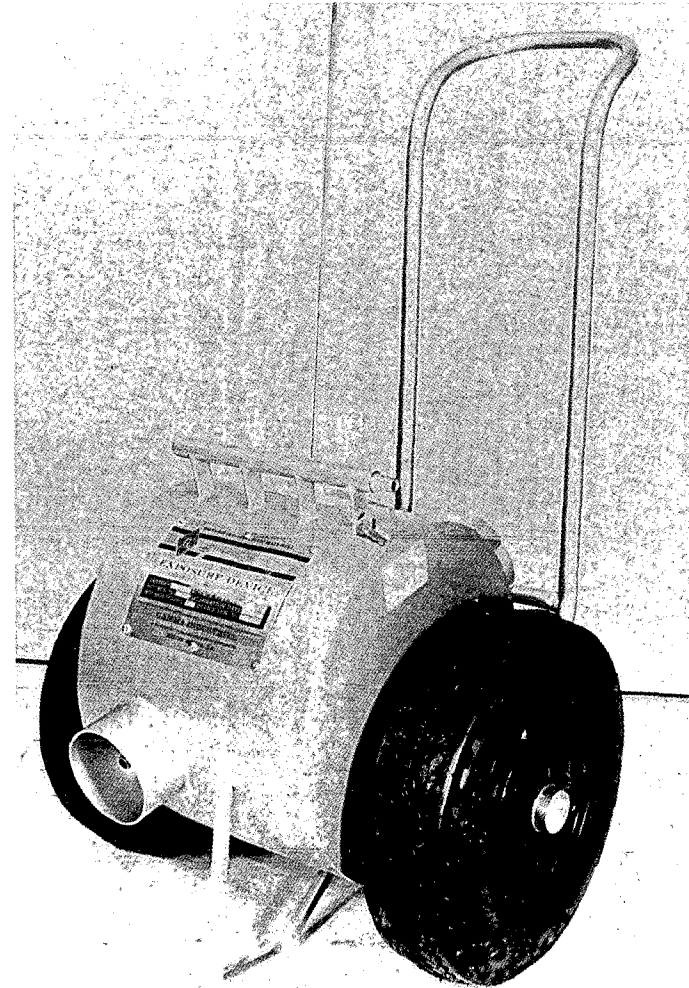

Figure 3. A mobile camera for 200 curies of cobalt-60. This camera weighs 475 pounds.

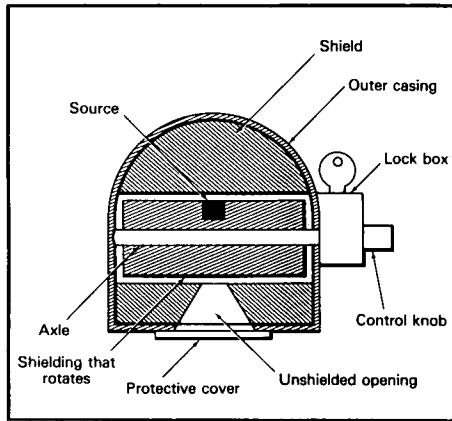

Figure 4. Diagram of a beam-type camera shown in safe (closed) position.

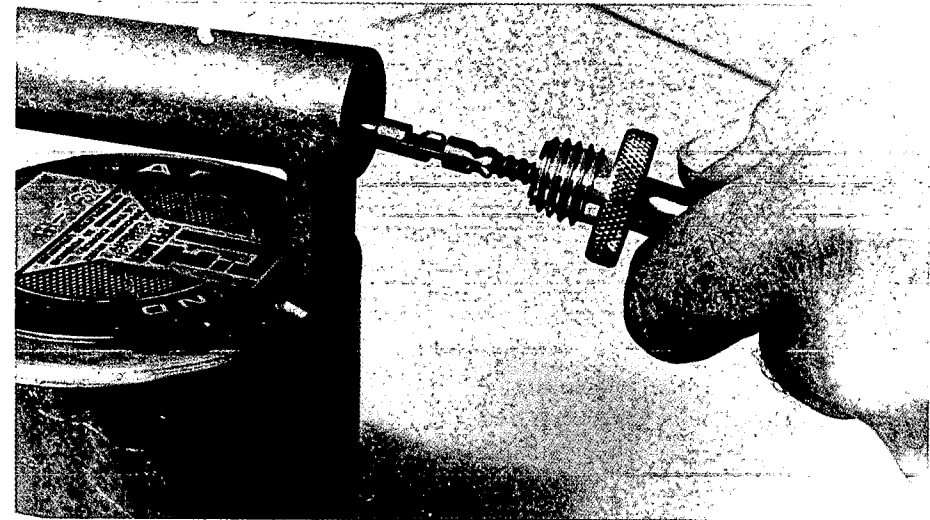

Figure 5. A beam-type camera for iridium-192. It operates using the knob in front or a drive cable that attaches to the handle.

Figure 6. Connecting a drive cable to the beam-type camera shown in Figure 5.

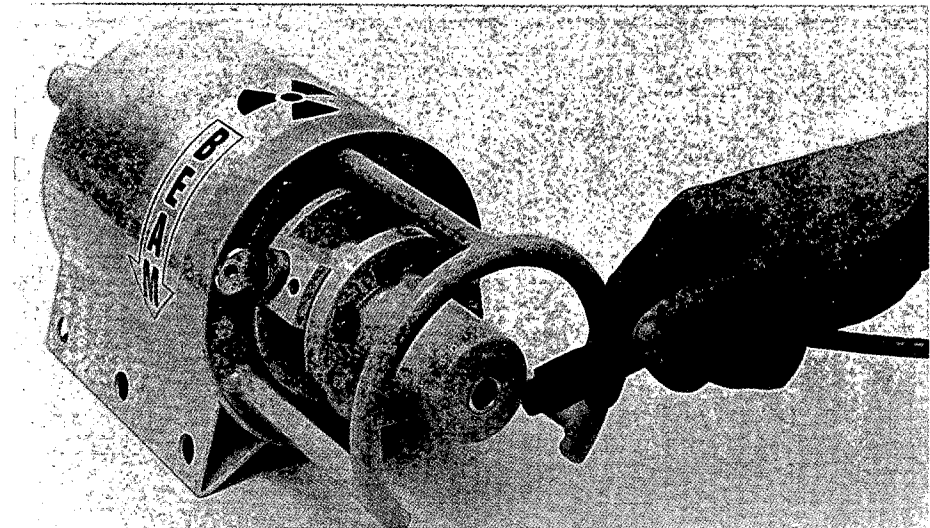
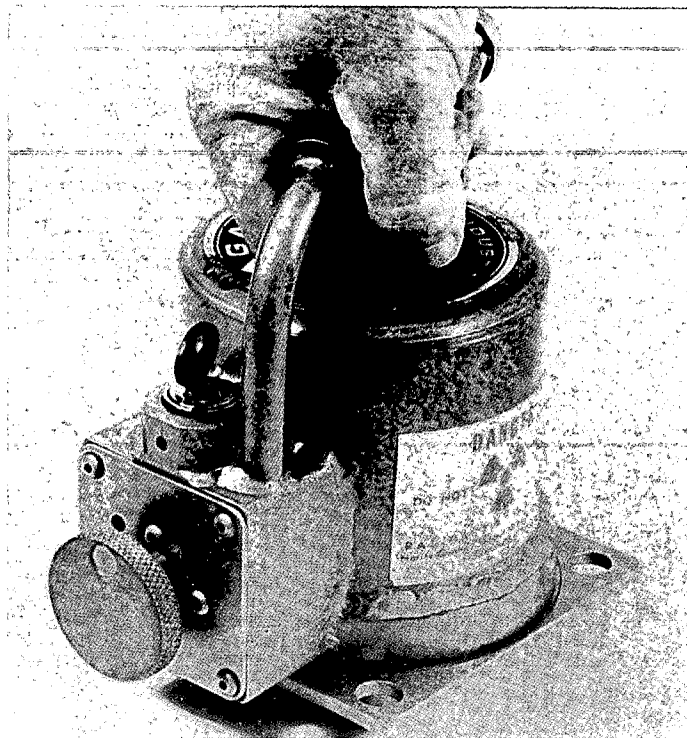

Figure 7. A vacuum-operated beam-type camera.

Daily Maintenance

Before you start work with a camera, you should check to see that it is in good operating condition. We describe here the general principles of maintenance. You should follow the detailed procedures that your employer will give you.

The description below of a daily check was written for crank-out cameras. But it can be applied to beam-type cameras, too, if you omit the checks on parts that your beam-type camera does not have (such as the guide tube and, sometimes, the drive cable).

1. Make a radiation survey of the camera. The radiation dose rate where you make the measurement should have its expected value. Survey the front of the camera. There should not be a beam of radiation, although the dose rate there may be a little higher than it is on the top or sides of the camera.
2. Check the camera for any visible damage.
3. Inspect the locking mechanism. Remove the cap, if any, and inspect the portion of the **pigtail** that you can see for frayed or broken strands or cracks. Figure 8 shows a radiograph of a pigtail cable whose strands have started to separate or "birdcage." Do not unlock the camera yet.

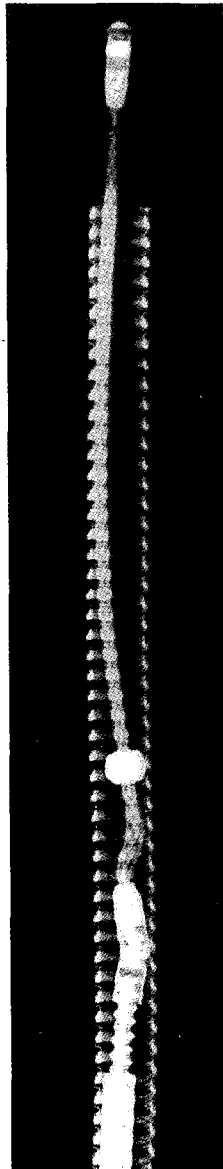
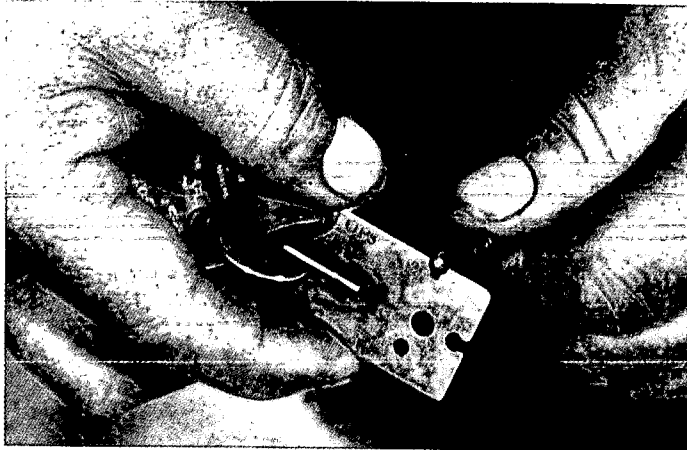
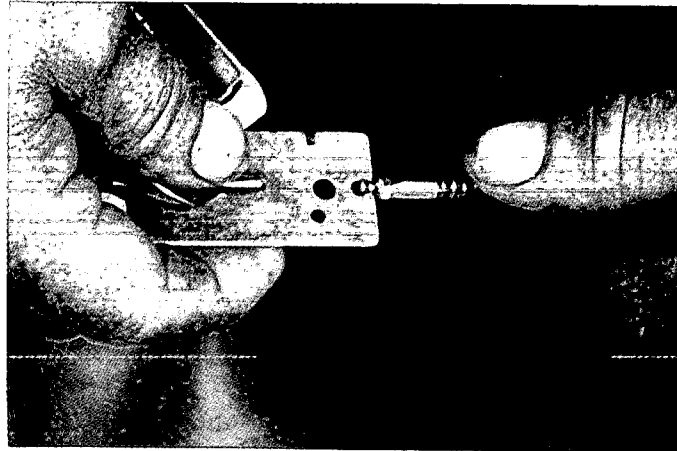

Figure 8. "Birdcaging" of a pigtail cable can cause eventual cable breaks or source hangups in the guide tube.

4. Look at the pigtail connector for signs of wear. Look at the drive cable connection for signs of wear. The photos in Figure 9 show a radiographer using "go/no-go" gauges to check for wear. This is a good thing to do occasionally. Also check connectors to see that they are not bent.
5. Connect the drive cable, but do *not* unlock the camera yet. Remove the safety plug from the front of the camera. Check to see that the source outlet is round and smooth so that the source will not get stuck there when you retract it.
6. Check the source guide tube for crimps, dents, fraying, and dirt. Figure 10 shows a dent in a guide tube that could cause a source to jam in the tube. Attach the guide tube to the camera. Check to see that it attaches without difficulty.
7. Check the lock for ease of operation. Lubricate if necessary.
8. During the first exposure of the day, check for any hangups or binding as you crank the source in and out.
9. If you note any problems, contact your supervisor and do not use the camera until it has been repaired.



1) Inspecting the neck area of the connector on the control cable.



2) Inspecting the ball on the connector on the cable for flat spots.



3) Inspecting the ball on the connector on the control cable for side wear.

Figure 9. Worn connectors can cause disconnects. This radiographer is using a "go/no-go" gauge to check for wear.

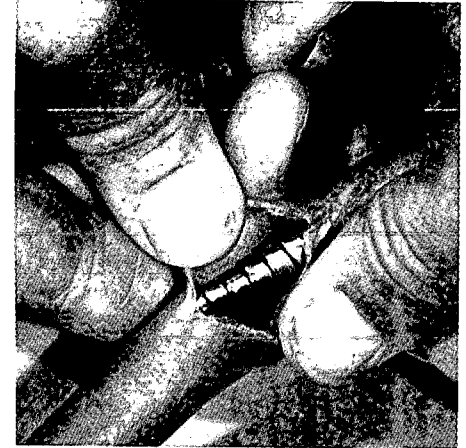

Figure 10. This guide tube has been crushed. A source can get stuck here. The guide tube must be repaired or replaced.

Quarterly Maintenance

Quarterly maintenance is done by specially trained personnel. Often these people are not radiographers. Although we call this "quarterly" maintenance to indicate a periodic maintenance, this maintenance should be done whenever necessary. Depending on how the camera is used, maintenance may be needed more often. Sometimes a quarterly check of the operation may find that no specific work is necessary. Generally, your supervisor will schedule the maintenance, but you should bring any problems you've noticed to his attention.

The most important thing is to clean dirt out of the camera, guide tube, cranking mechanism, and drive cables. Dirt-clogged tubes, cables, and cranks can make it impossible to fully retract the source. Dirt can also prevent the locking mechanism from operating correctly.

Whenever the guide tube and drive cables become dirty, they should be cleaned according to the manufacturer's instructions. Disconnect the drive cable from the crank, and remove it from its protective tubing. Clean it in a recommended solvent. Pour a recommended solvent into the protective tubing and the guide tube. Blow the solvent out the other end using compressed air. Lubricate the drive cable as recommended. Lubricate the locking mechanism as recommended by the manufacturer.

In general, the camera itself should not be disassembled unless there is a definite need to do so. Disassembly of a camera containing a source could result in a serious radiation overexposure. Also, disassembly of a properly functioning camera may cause more problems than it solves, especially if the camera is not perfectly reassembled.

Discussion

This is a good time to ask your instructor questions about the operation and maintenance of the cameras you will be using.

8

What Are The Basic Rules For Radiography?

Who Regulates You?

Reciprocity

Offshore Work Sites

NRC Regulations



“...Any person who willfully violates any provision of the Act or any regulation or order issued thereunder may be guilty of a crime and, upon conviction, may be punished by fine or imprisonment or both, as provided by law.” [NRC Regulations, Section 20.601]

In your work as a radiographer’s assistant, you have already been following your company’s operating procedures. These procedures have been written to conform with federal and state regulations. Knowing these regulations will help you better understand your company’s procedures. Understanding the regulations and following approved procedures may not necessarily lead to better radiographs, but it will lead to a safer work environment.

Who Regulates You?

Because of the hazards of radiation, the United States Congress passed a law giving the **U.S. Nuclear Regulatory Commission (NRC)** the responsibility for regulating the use of most radioactive materials used in gamma radiography (such as iridium-192 and cobalt-60). X-ray radiography, accelerator radiography, and radiography using radium-226 are regulated by the individual states and by the U.S. Occupational Safety and Health Administration (OSHA). The NRC has no authority to regulate radiography using x-ray machines, accelerators, or radium-226.

The NRC can relinquish to any state government its authority to regulate the use of radioactive materials in gamma radiography if the state (1) wants the authority and (2) provides adequate resources to ensure that radioactive materials are used safely.

As of November 1982, 26 states had accepted this responsibility. These states are called **Agreement States**. They have signed an agreement with the NRC that ends NRC authority within the state, except at federal institutions. The states regulate gamma radiography performed within their boundaries. A

map showing the Agreement States is shown in Figure 1. States that do not have an agreement with the NRC to regulate gamma radiography within the state are called **non-Agreement States**. Gamma radiography in non-Agreement States is regulated by the NRC.

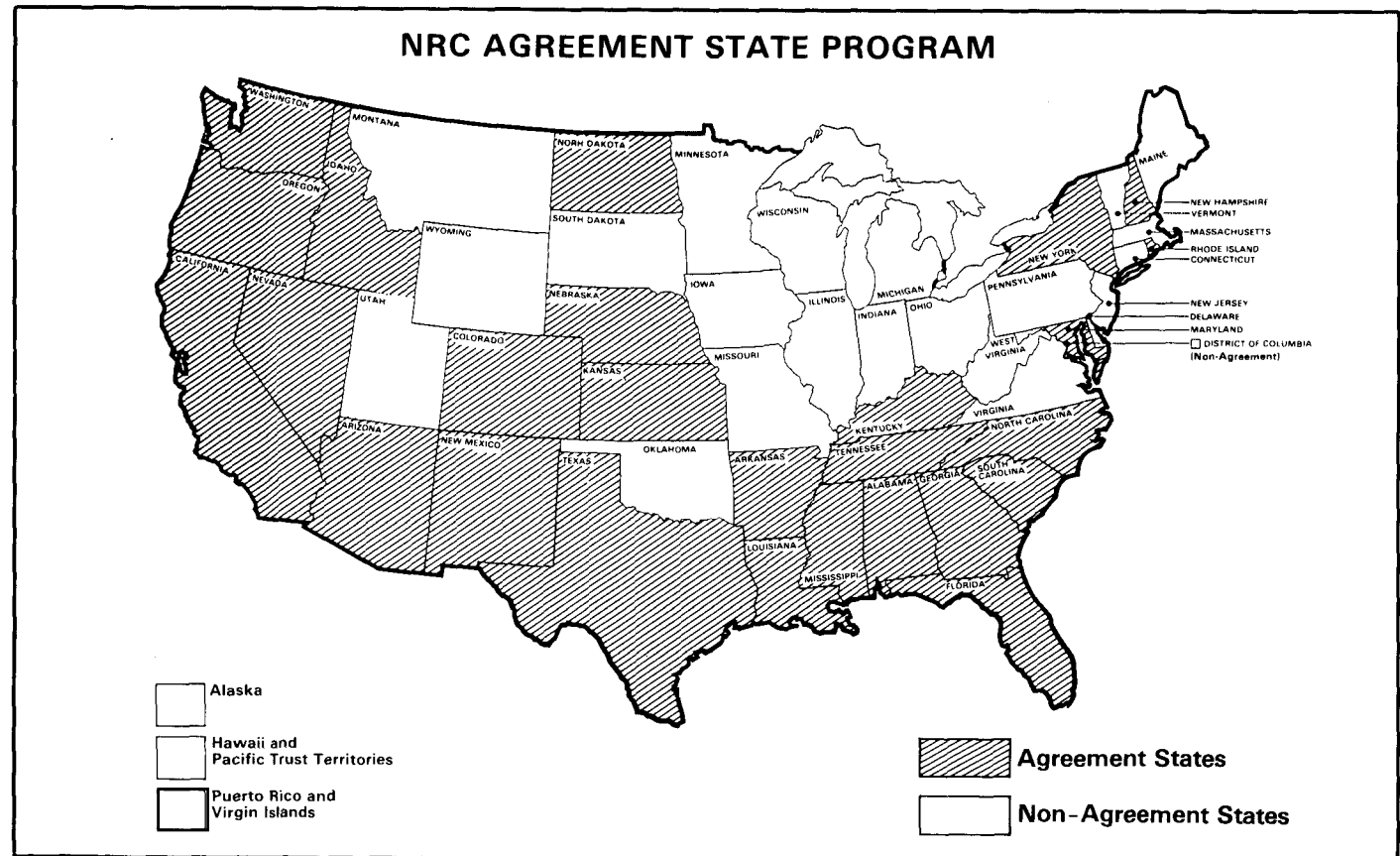

Figure 1. Map showing NRC Agreement States.

Your company must have a license to perform gamma radiography using radioactive materials. If your company is located in a state where the NRC regulates radiography (a non-Agreement State), the company must have an NRC license. If your company is located in an Agreement State, the company must be licensed by that state. If your company performs industrial radiography using x-rays only, the radiography is regulated by the state where it is performed, whether it is an Agreement State or a non-Agreement State.

Both the NRC and the Agreement States have regulations that must be followed. By federal law, Agreement State regulations must be *compatible* with NRC regulations. *Compatible* means that in certain important areas, the state regulations must be the same as NRC regulations. Therefore, Agreement State regulations are much the same as NRC regulations, but they are not identical.

This manual discusses NRC regulations. As part of your training, your employer must provide you a copy of relevant NRC regulations. If you will be working in an Agreement State you must learn about any differences between NRC regulations and the state's regulations. The addresses and telephone numbers of the Agreement State regulatory agencies are listed in Appendix A. You can obtain copies of the state regulations from those agencies. The address where you can obtain

up-to-date copies of NRC regulations is given in Appendix C.

Reciprocity

What happens if your company is licensed in one state by either the NRC or by an Agreement State and wants to perform radiography in a different state where different regulations are in effect? Your company may do so without applying for a new license. The license your company holds will be recognized and accepted in other states. This is called **reciprocity**.*

Reciprocity works the same for radiography licenses as for licenses to drive automobiles. You are issued a *driver's license* by the state that you live in. You can use that license to drive in any other state, because each state recognizes the driver's licenses of every other state. But you obey the traffic laws of the state where you are driving rather than the laws of the state that issued your driver's license. The same is true for radiography.

For example, let's assume your company is located in New York, an Agreement State, and has a New York State license. You are sent to work in New Jersey, a non-Agreement State, where radiography is regulated by the NRC. First, your company must inform the NRC of the dates that you will be

*Details of reciprocity are found in NRC regulations, 10 CFR, Section 150.20, "Recognition of Agreement State Licenses."

working in that state. Your company informs NRC by sending three copies of Form NRC-241 (see Appendix D for a copy of this NRC form) and three copies of its state license at least 3 days in advance. NRC limits companies licensed by an Agreement State to working a total of 180 days per calendar year in non-Agreement States.

After you enter New Jersey, you are subject to NRC's regulations (Figure 2). *You always obey the regulations in effect in the state where you are working, rather than those rules of the state where your company is licensed.* In Agreement States, you must comply with the regulations of the particular Agreement State. In non-Agreement States, you must comply with NRC regulations.

You are also subject to inspection by the regulatory authorities of the state where you are *working*. In this case, you would be inspected by NRC inspectors, not New York State inspectors, even though your company holds a New York State license, not an NRC license. The NRC inspectors would make sure you were obeying NRC regulations while working in New Jersey, not New York State regulations.

If you want to work in an Agreement State where you are not licensed, your company must inform that state in advance (at the addresses listed in Appendix A).

Under reciprocity your company is usually limited in performing radiography to a total of 180 days per calendar year in any Agreement State where it is not licensed. If the company keeps radiography sources in an Agreement State where it is not licensed for more than 180 days, it must obtain a license from the authority responsible in that state. The following Agreement States, however, have periods different from 180 days: Idaho (20 days), Kentucky (unlimited), and Louisiana (unlimited).

Offshore Work Sites

Who regulates you when you work offshore? Both the water and the land underneath the water off the shore or coast from any state are considered to be part of that state within an area of about 3 miles for most states (and about 10 miles for the Agreement States of Florida and Texas). This area can be called a state's territorial limit.

Radiography performed within an Agreement State's 3-mile or 10-mile territorial limit is regulated by the state. Radiography performed outside this 3-mile or 10-mile limit (including the high seas) by any company licensed by the NRC or an Agreement State is regulated by the NRC.¹ However, the NRC has an agreement with Louisiana that allows Louisiana to perform these offshore inspections for the NRC.*

*As of December 1981, the NRC was considering similar agreements with Texas and California.

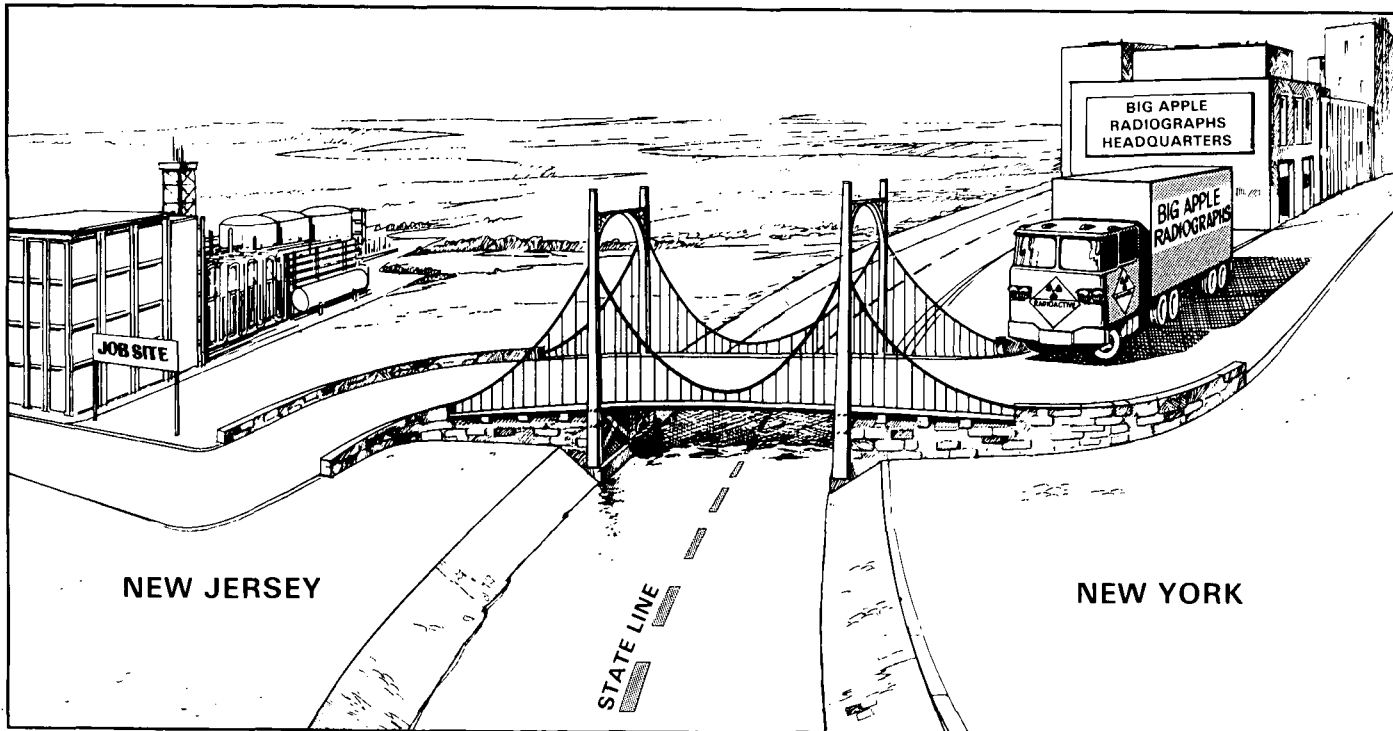

Figure 2. Reciprocity. When radiographers who are licensed in New York, an Agreement State, work in New Jersey, where the NRC regulates radiography, they work under NRC regulations.

Your company should check NRC regulations (10 CFR Section 150.20) to determine whether it must notify NRC or the Agreement State before it begins performing radiography beyond the 3-mile or 10-mile limit.

NRC Regulations

The Act of Congress that gave NRC the authority to regulate industrial radiography using radioactive materials also gave NRC the authority to issue regulations. These regulations are like laws. It is illegal to disobey them. Violations of these regulations can result in monetary fines, loss of your company's license, or even criminal penalties such as jail sentences.

The complete set of regulations issued by all federal agencies is called the **Code of Federal Regulations (CFR)**. The code is composed of many *Titles*. Different titles are issued by different federal agencies. Some titles are made up of several chapters. The NRC's regulations are Title 10 of the Code of Federal Regulations. This is often abbreviated 10 CFR. Title 10 has one chapter.

Title 10 is composed of many separate *Parts*. In particular, Parts 19, 20, and 34 are especially important

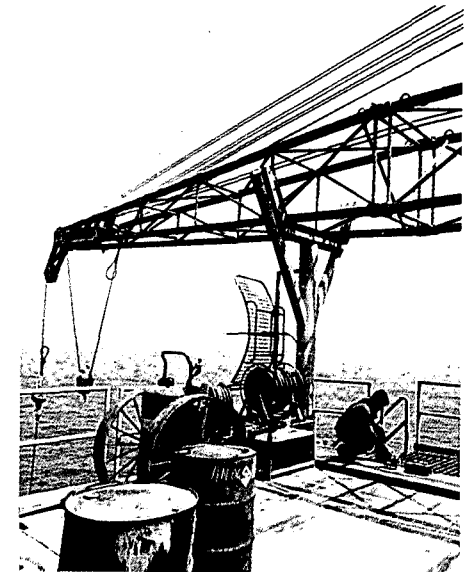

Figure 3. Any radiography done offshore (not within the territorial limits of an Agreement State) is regulated by the NRC.

to you. Copies of each of these parts must be provided to you for your training [§ 34.31(a)].*

Part 19 — Your Bill of Rights

Part 19, "Notices, Instructions and Reports to Workers; Inspections," could be called your "Bill of Rights" because it covers your rights as a worker. Following are the important provisions of Part 19.

*The notation in the [] identifies specific sections in Title 10 of the Code of Federal Regulations. For example, [§ 34.31(a)] means paragraph (a) of Section 34.31 of Part 34.

1. Training [§ 19.12]

You have a right to adequate training to protect yourself against radiation. Your company must provide you with adequate training to do your job safely and to avoid excessive exposure to radiation. Training is discussed more specifically for radiographers in Part 34 [§ 34.31]. This manual covers some of the information you must know. You must also learn your company's own operating and emergency procedures.

2. Reports of Radiation Dose [§ 19.13]

You have a right to know how much radiation you have been exposed to. Your company is required to keep a record of your radiation dose (such as on Form NRC 5 in Appendix D). At your request, your company must tell you in writing each year how much radiation you received that year.

Any company must also provide former employees, if they request it, a record of their radiation dose within 30 days of their request. Your company must report to you your dose within 30 days if you have been overexposed. When you terminate your job, your company must send you a report of how much radiation dose you received while you were employed by that company.

3. Talking to NRC Inspectors [§ 19.15(b)]

During an inspection, you have a right to talk to NRC inspectors. You can privately bring to the attention of NRC inspectors any safety concerns you may have, either orally or in writing.

4. Requesting an NRC Inspection [§ 19.16 and § 19.17]

You have a right to request that the NRC conduct an inspection if you think there are safety problems. These requests should be made in writing to your regional NRC office. Your employer will be given a copy of your letter. However, you may request in your letter that your employer not be told who made the complaint or not be told the names of other workers mentioned in your letter.

If you are not sure whether you want to write the letter or are not sure if there really is a safety problem, you can telephone the NRC regional office to discuss your problem with them (see Appendix B for addresses and telephone numbers).

You have a right to expect that the NRC will pay careful attention to your problem.

If you file such a complaint of a safety problem, your employer may not fire you or discriminate against you in any way as a consequence of filing the complaint.

If the NRC does not agree with your letter about the existence of a safety problem, they must tell you in writing why they don't think your employer (the licensee) is in violation of the regulations.

5. A Worker Representative May Accompany an NRC Inspector on an Inspection [§ 19.14]

If workers have selected someone to represent them, for example, by labor union selection processes, the licensee must inform the NRC inspector of that person and must allow that person to accompany the NRC inspector during the inspection of the workplace. The workers' representative must be routinely engaged in licensed activities under control of the licensee and must be trained in radiation protection (as described in § 19.12).

Part 20 — Basic Radiation Safety

Part 20, "Standards for Protection Against Radiation," sets down the basic terms and rules for radiation safety, including radiation dose limits. We will discuss here *only* those requirements in Part 20 that are not covered in more detail in Part 34.

1. Radiation Dose Limits* [§ 20.101 and § 20.102]

The NRC has quarterly (3-month) radiation dose limits. The following are the NRC limits for adults in areas where access is restricted for the purpose of radiation protection:

Radiation Dose Limits	
Whole body	1¼ or 3 rems per quarter year (as explained below)
Hands, forearms, feet, ankles	18¾ rems per quarter year
Skin of the whole body	7½ rems per quarter year

The limit on radiation delivered to the whole body is 3 rems per quarter year if your employer keeps records to show that your lifetime radiation dose does not exceed 5(N-18) rems, where N is your age in years. For example, if you are 28 years old, your lifetime dose

*Note: In this manual, we are concerned only with radioactive sources located *outside* the body. In Chapter 3, we mentioned that radioactive materials can also be taken *into* the body, for example, by inhaling radioactive materials. There are separate NRC limits for such intakes of radioactive materials into the body. But we do not consider those limits here. They are not relevant because the radioactive materials in radiography sources are sealed inside steel capsules that rarely allow particles of radioactive material to get into the air.

cannot exceed 50 rems [5(28-18) = 50]. This means your average annual dose for those years over 18 cannot exceed 5 rems per year.

If your employer uses the 3-rem-per-quarter dose limit, the company must keep records to show that your lifetime dose since age 18 has been limited to an average of 5 rems per year. The form used to keep track of your past dose is called Form NRC-4, shown in Appendix D.

If your employer does not keep an up-to-date copy of Form NRC-4 (or equivalent) giving your lifetime radiation dose history, your employer must use a quarterly dose limit of 1.25 rems instead of 3 rems.

The whole-body dose is a measure of the amount of radiation that has been received by a large portion of your body, particularly the parts important from a radiation protection point of view. These parts are the bone marrow where leukemia would originate or the gonads where genetic damage to offspring would originate. Usually the dose reading on the film badge or TLD is considered to be the whole-body dose.

If you are under the age of 18, the dose limits are one-tenth (10%) of the amount allowed an adult.* For example, a minor under 18 years old is permitted a quarterly whole-body dose of only 0.125 rems or 125 millirem [§ 20.104].

The NRC permits higher dose limits, 18³/₄ rems, to hands and feet [§ 20.101]. Still you should not touch a radiography source since the dose to your hands would be much higher than that limit. Doses to the hands are not normally calculated for radiographers unless the radiographer is involved in a radiation overexposure accident.

There is a special limit on radiation dose to the skin from radiation that does not penetrate beyond the skin. This limit for the skin is rarely of interest to radiographers. Skin dose generally comes from beta particles. Beta particles can expose the skin but usually do not have enough energy to reach deeply into the body. Therefore, they do not contribute to the whole body dose. The radioactive materials in radiography sources emit beta particles, but the beta particles do not penetrate the steel capsule containing the radioactive material.

*Note, however, that Department of Labor regulations prohibit individuals under the age of 18 from working in occupations involving exposure to radiation [29 CFR § 570.120 and § 570.57]. You are not allowed to work as a radiographer if you are younger than 18.

2. Restricted Areas, Unrestricted Areas, Radiation Areas, and High Radiation Areas

a. Restricted Areas [§ 20.3(a)(14)]. A **restricted area** is an area to which the licensee restricts access for the purpose of radiation protection. Restricted areas are established to protect the public from radiation. You cannot let anyone into a restricted area unless the person has been told of the presence of radiation in the area and told what to do to avoid or control their exposure to radiation [§ 19.12]. If you are at a field site, you will frequently use ropes and signs to mark off the restricted area and keep people from entering. If people ignore the ropes, you should be prepared to approach them and tell them that a radiation source is in use and that they should keep away.

b. Unrestricted Areas [§ 20.105(b)]. An **unrestricted area** is an area where access is not restricted. The maximum dose allowed to anyone in any area where access is not restricted is *2 mrem in any 1 hour or 100 mrem in any 7 consecutive days*. (In Chapter 5, we worked problems on how to calculate doses such as 2 mrem in any 1 hour.) Often radiographers find it convenient to simply set up restricted area boundaries where the dose rate is *less than 2 mR/hr*.

c. Radiation Areas [§ 20.202(b)(2)]. A **radiation area** is an area in which radiation exists where anyone could receive a dose to a major portion of the body in excess of 5

mrem in any 1 hour or 100 mrem in 5 consecutive days. Radiation areas must be posted with signs saying "Caution, Radiation Area" (the sign can also say "Danger" in place of "Caution") and displaying the radiation symbol [§ 20.203(b)].* These are shown in Figure 4.

In radiography, the radiation area will be not very different in size from the restricted area. Therefore, it is often practical to post the radiation area signs at the restricted area boundary and not have a separate radiation area.

d. High Radiation Areas [§ 20.202(b)(3)]. If the dose to anyone could *exceed 100 mrem in any 1 hour*, the area is a **high radiation area**. High radiation areas must be posted with a sign saying "Caution, High Radiation Area" and displaying the radiation symbol, as shown in Figure 4. (The sign can also read "Danger" in place of "Caution.")

3. Receiving Radioactive Sources [§ 20.205(a)]

Licensees must promptly pick up packages from shippers as soon as they are notified the packages are ready. This reduces the chance that someone unfamiliar with radiation will accidentally mishandle a potentially dangerous source.

*Some of the requirements of Part 20 such as posting signs are discussed in more detail under the discussion of Part 34.

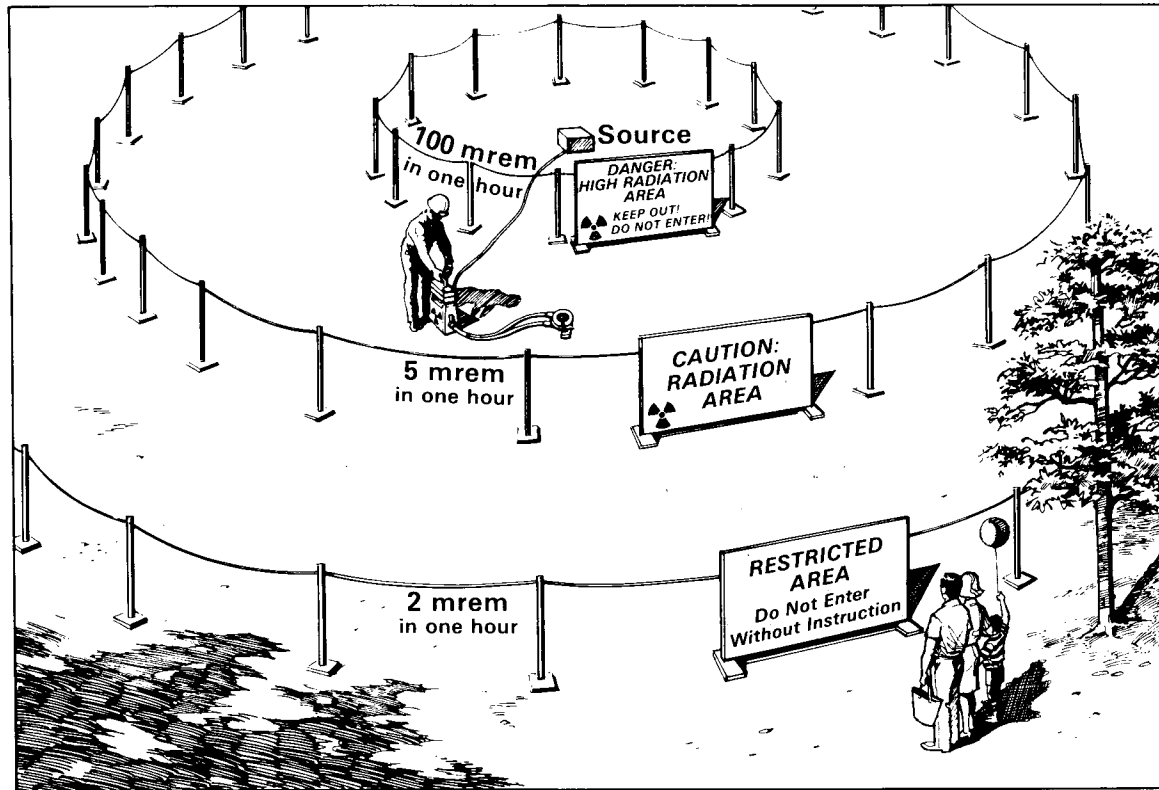

Figure 4. Restricted, Radiation, and High Radiation Areas. In practice, a radiographer is likely to use only a single rope barrier. The radiation area and restricted area would be combined into one and located at the 2 mrem in any 1 hour boundary. Ropes would not be used for the high radiation area.

radiography. The licensee, your employer, has the responsibility in the eyes of the NRC to see that the regulations are obeyed. The company establishes **operating and emergency procedures** so that you can work in a way that meets the regulations. However, since you are the person who must actually do the work, you become responsible to your employer to see that the regulations are obeyed.

We mentioned that Part 19 forbids your employer from firing or discriminating against you if you complain to the NRC about safety problems. *However, your employer may discipline you or fire you if you fail to obey the regulations.*

The basic provisions of Part 34 that you must follow are discussed here.

1. Radiation Surveys [§ 34.43]

The most important thing that you must do to protect yourself and anyone near you is to perform adequate radiation surveys with your survey meter. Most of the radiography overexposure accidents reported to the NRC happened when a radiographer did not make a survey or surveyed improperly. A survey meter must be used. Visual surveys are not acceptable.

4. Reporting a Lost or Stolen Source [§ 20.402(a)]

You must immediately notify your supervisor of the loss or theft of a radiography source so that the company can immediately notify by telephone the regional NRC office (Appendix B). Radiography sources can be very dangerous to anyone who does not understand the danger or the precautions necessary with a radiography source.

5. Reporting Radiation Overexposures [§ 20.403 and § 20.405]

Overexposures must be reported to the NRC. Your company must immediately notify the NRC regional office (Appendix B) by telephone if anyone is overexposed to radiation *exceeding 25 rems whole body or 375 rems to the hands or feet.* They must notify the NRC regional office within 24 hours of a radiation overexposure *exceeding 5 rems to*

the whole body or 75 rems to the hands or feet. Lesser overexposures must be reported within 30 days.

Part 34 — Your Responsibilities

Part 34, "Licenses for Radiography and Radiation Safety Requirements for Radiographic Operations," contains some of the things you are required to do while performing

You must perform the following surveys:

(1) A survey of the camera and guide tube after each radiography exposure to make sure that the source is in its shielded position. We discussed how to make this survey in Chapter 6.

(2) A survey of the restricted area boundary to make sure that no person outside the restricted area could receive a dose of more than 2 mrem in any 1 hour or 100 mrem in any 7 consecutive days [§ 20.201(b) and § 20.105(b)(1)]. Your survey meter will tell you the *dose rate*, for example, 10 mR/hr. To obtain the *dose*, multiply the dose rate by the fraction of the hour that the source will be exposed. We showed you how to do this in Chapter 5.

If you are good at doing these calculations, you will be able to convert any survey meter reading into the dose. If you are not very good at calculations, you can assume that the source is exposed for the whole hour. As long as your meter reading is less than 2 mR/hr, the dose at the restricted area boundary is acceptable.

2. Posting of Signs [§ 34.42]

Signs are posted to warn other people that radiation is present in the area and that they should be careful to avoid the area. Ropes are often used with the signs, although the regulations do not specifically require ropes. You must post *radia-*

tion area signs, generally at the restricted area boundary, and you must post *high radiation area* signs anywhere the dose is sufficient to expose anyone to a dose of 100 mrem in any one hour.* No radiation survey is necessary at the high radiation area boundary. The signs must be conspicuously posted so that anyone approaching these areas can see them [§ 20.203(b) and (c)].

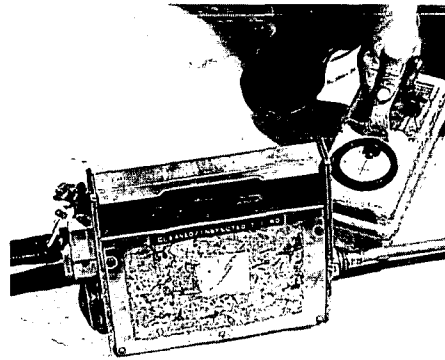

Figure 5. Probably the most important survey you will make is the survey of the camera *after* an exposure. The radiographer here is surveying the guide tube entrance. This is a particularly important place to survey because the source can get hung up as it reenters the camera, or it can creep out after it has been fully retracted.

*You may post *high radiation area* signs at the restricted area boundary and omit *radiation area* signs. But if you do this, all the requirements for the high radiation area will apply to the entire area, for example, surveillance to protect against unauthorized entry.

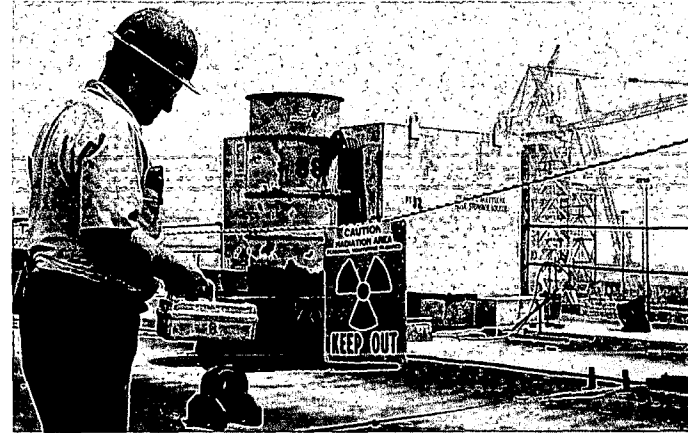

Figure 6. During the first exposure, this radiographer surveys the restricted area boundary to measure the *dose rate*.

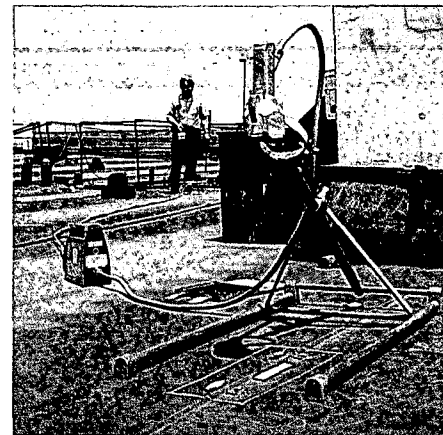

Figure 7. This is another view of the same survey of the restricted area boundary. Note that the radiographer has used a collimator to reduce the distance to the restricted area boundary. The radiographer will *not* survey the *high radiation area* near the source. Such a survey would needlessly expose him to high levels of radiation.

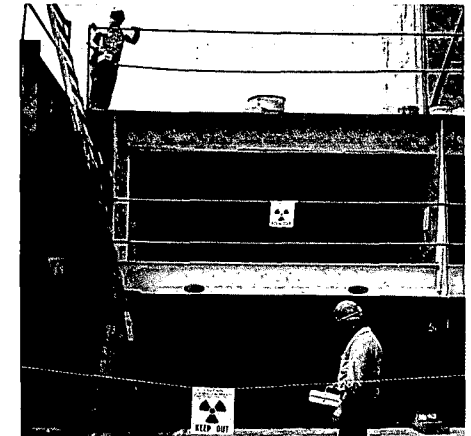

Figure 8. The radiography shown in the previous figures is being done on the hull of a ship being constructed. The restricted area and the high radiation areas extend beneath the deck shown in the previous figures. This figure shows another radiographer making a survey of the restricted area boundary below the deck. The radiographer on the deck has moved to the edge of the deck in making his survey of the restricted area boundary.

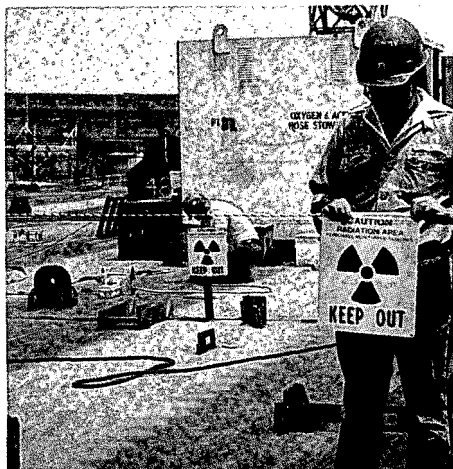

Figure 9. The radiographer in front has established a restricted area by surrounding the area with a rope. He is now posting a radiation area sign on the restricted area boundary. He has already posted a high radiation area sign near the source (seen in the background).

3. Security for the High Radiation Area § 34.41]

You are responsible to see that no one enters the high radiation area while a radiography source is exposed. If it is possible for anyone to enter the high radiation area, you must maintain direct visual surveillance of the area and prevent them from entering. Your personal surveillance may not be necessary if there are other means of preventing an individual from being exposed. For example, if an area is locked so no one can enter it, surveillance is not necessary. Your personal surveillance also is not necessary if the source will automatically retract when someone approaches or if there is an alarm system that will warn both the person and you that the source is being approached [§ 20.203(c)(2)].

4. Personnel Monitoring [§ 34.33]

Whenever you work with a radiography source, you must have a pocket dosimeter and, in addition, either a film badge or TLD badge. You must recharge and read the pocket dosimeter every day. You must record the results. It is also a very good idea to read it several times during the day to make sure you are not unknowingly being ex-

posed to radiation. If your pocket dosimeter reads off scale, you must give your film badge or TLD to your supervisor for immediate processing. Your employer must keep records of the radiation dose you have received.

Figure 10. A radiation area sign has been posted in the foreground. Because the radiation will penetrate the ship's deck, restricted areas and high radiation areas must also be posted below the top deck. The radiographer on the right is posting high radiation area signs around the area directly below the source.

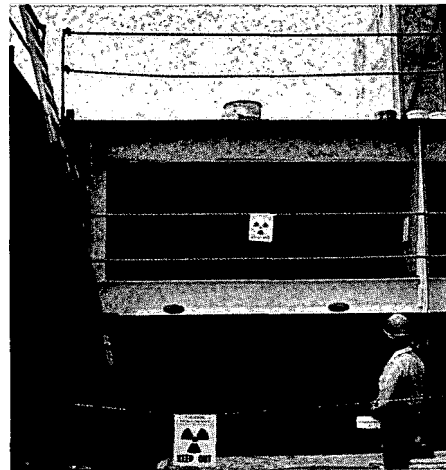

Figure 11. During the exposure, the radiographer shown here keeps his eyes on the lower decks to make sure no one enters the high radiation area. The other radiographer on the top deck will be doing the same thing up there. Two radiographers are needed to maintain surveillance of the high radiation area because a single person could not keep all the levels under surveillance at the same time.

posed to radiation. If your pocket dosimeter reads off scale, you must give your film badge or TLD to your supervisor for immediate processing. Your employer must keep records of the radiation dose you have received.

5. Locking of Cameras [§ 34.22]

After each exposure, the source must be secured in the camera (not necessarily locked with a key) to make sure it is in a safely shielded position. Pushing down a plunger or rotating a locking ring are ways



a) At the start of work, the radiographer charges his dosimeter. He will write down the dose that the dosimeter indicates.



b) This radiographer is checking the reading on this pocket dosimeter. This is a good check from time to time to make sure you have not gotten excessive radiation exposure.

Figure 12. Pocket dosimeters.

this can be done on different types of cameras. Pushing a plunger down is shown in Figure 13.

You cannot leave a radiography source unsecured so that anyone who happens along could crank out the source and expose themselves, you, or another person to radiation. In addition, you must lock the camera with a key whenever it will not be under your direct surveillance or control.

6. Storage of Sources [§ 34.23]

You must protect the radiography camera from being stolen, tampered with, or removed by any unauthorized person. Place the camera in a locked storage area or locked truck before you leave it unattended. Both the storage area and the truck must be posted with a sign saying "Caution, Radioactive Materials" and bearing the radiation symbol. You may *not* leave a camera unattended in an unrestricted area — even if you have locked the source in and removed the key from the camera.

7. Survey Meters [§ 34.24]

You must use a survey meter that has been calibrated within the previous 3 months. If the survey meter has been repaired, it must be recalibrated before it can be used again. The survey meter must be able to read from 2 mR/hr to 1 R/hr.



Figure 13. A radiographer secures the source in the camera after an exposure by pushing a plunger. He will not remove the key until he puts the camera into storage.

8. Leak Testing [§ 34.25]

Radiography sources cannot be used unless they have been leak-tested within the last 6 months. The test is to make sure that radioactive materials are not leaking out of the source. Figures 17, 18, and 19 in Chapter 6 showed leak testing.

9. Quarterly Inventory [§ 34.26]

Every 3 months your company must account for all the radiography sources it has.

10. Utilization Logs [§ 34.27]

For any radiography source assigned to you, you must make a record of where and when you use it and in what camera or storage container it is being kept.

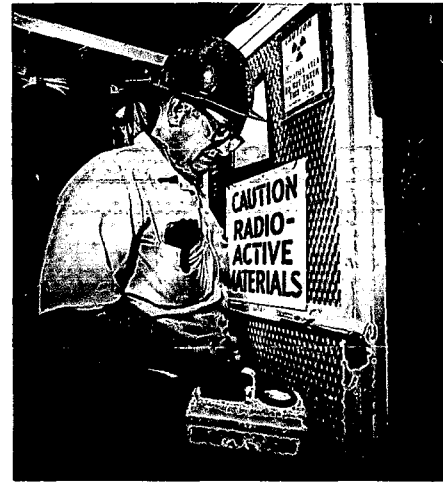

Figure 14. Radiography cameras cannot be left unattended. When not in use, they must be stored in a locked area to prevent unauthorized people from taking the camera. Note the radiographer surveying as he goes to take a camera out of storage. Note also the warning signs that are posted.

11. Inspection and Maintenance of Cameras [§ 34.28]

You must check your camera for obvious defects each day before you use it to make sure it is in good working order. Radiography cameras must also be inspected and maintained every 3 months. The person performing the quarterly inspection and maintenance should be specifically trained to do so.

12. Gamma Alarms at Permanent Installations [§ 34.29]

Permanent radiographic installations (except those with automatic source retraction devices) must have visible and audible warning signals. The visible signal such as a light must be activated by radiation when the source is exposed. The audible signal must be activated if anyone enters the room while the source is exposed.

Note that the gamma alarm does not replace the security requirements for high radiation areas that we discussed earlier. The security requirements are to prevent unauthorized personnel from entering the high radiation area. The gamma alarm is to prevent you, the radiographer, from mistakenly entering the room while the source is exposed.

13. Training [§ 34.31]

You must be instructed in the subjects covered in this training manual, and you must study case histories of radiography accidents.* In addition, you must be instructed in your company's operating and emergency procedures. You must know how to operate the equipment you will use. This usually requires several months of on-the-job training. You must pass a test on these subjects to show that you understand them.

*Such as the case histories in "Case Histories of Radiography Events," NUREG/BR-0001, Volume 1, 1980.

14. Supervision of Radiographer's Assistants [§ 34.44]

A radiographer who is supervising a **radiographer's assistant** must be present, able to give assistance, and be watching the assistant whenever the assistant uses a radiography source or makes a survey to determine that the source has returned to its safe shielded position after an exposure.

Figure 15. Never start work without proper safety equipment: survey meter, film or TLD badge, pocket dosimeter, collimators, ropes, and signs.



Questions

True Or False

- | | | | |
|-----|---|---|---|
| 1. | T | F | The use of x-rays to perform industrial radiography is regulated by the Nuclear Regulatory Commission. |
| 2. | T | F | Agreement State regulations must be very similar to the NRC regulations in all important safety matters. |
| 3. | T | F | Agreement State regulations must provide as much protection of public health and safety as NRC regulations. |
| 4. | T | F | If your company is licensed by an Agreement State, it can only perform radiography in that state or in another Agreement State. |
| 5. | T | F | Wherever you are working, you only need to obey the regulations in effect in the state where your company is licensed. |
| 6. | T | F | If your company has an NRC license and the job site is in an Agreement State, you must notify the state before starting work there. |
| 7. | T | F | Radiography conducted beyond the 3-mile territorial limit is not subject to NRC or state regulations. |
| 8. | T | F | Violations of NRC regulations can result in monetary fines and loss of your company's license. |
| 9. | T | F | Your company must tell you the dose you receive each year, but only if you request it. |
| 10. | T | F | If you have been overexposed to radiation, your company must tell you that you have been overexposed. |

True Or False				True Or False			
11.	T	F	When you quit your job, you can receive a record of the radiation dose you received, but only if you request it.	22.	T	F	You must always survey the camera with a survey meter after every exposure of the source.
12.	T	F	You can request that the NRC conduct an inspection of your company if you think there are safety problems.	23.	T	F	You must survey the boundary of the high radiation area during every exposure of the source.
13.	T	F	You can talk privately to NRC inspectors during inspections.	24.	T	F	You must survey the boundary of the radiation area during every exposure of the source.
14.	T	F	If you write a letter to the NRC complaining of safety problems at your company, the NRC need not reply if it does not agree with your claims.	25.	T	F	You must survey the boundary of the restricted area during every exposure of the source.
15.	T	F	A worker representing the other workers at your company may accompany an NRC inspector during an inspection if he wants to.	26.	T	F	If the restricted area does not have locked doors, an alarm, or an automatic source retraction device, you must maintain surveillance of the entire restricted area to make sure no one enters.
16.	T	F	The limit on radiation dose to the whole body during a 3-month period is 5 rems.	27.	T	F	If you have a reliable pocket dosimeter, you do not also have to have a film or TLD badge.
17.	T	F	The NRC has a weekly dose limit of 1¼ rems.	28.	T	F	You must read your pocket dosimeter after each exposure.
18.	T	F	Anyone who is not a radiographer or radiographer's assistant cannot enter a restricted area.	29.	T	F	You must recharge your pocket dosimeter weekly.
19.	T	F	The maximum dose in any area that has unrestricted access is 5 mR in any 1 hour.	30.	T	F	If your pocket dosimeter goes off scale, you should recharge it and return to work.
20.	T	F	Restricted areas must always be enclosed by ropes or other barriers.	31.	T	F	You can leave a camera untended in the back of a pickup truck if the source is locked and the key is removed.
21.	T	F	Lost or stolen sources must be promptly reported to the NRC or an Agreement State.	32.	T	F	You must check to be sure your camera is in good working order each day before starting work.

Discussion Questions

1. You are a radiographer working at a field site. You have established a restricted area and are getting ready for a shot. Another radiographer for some reason ignores the restricted area ropes and enters the area. When you approach him and tell him to keep away, he tells you that he has been a radiographer for more than 10 years and knows what he is doing. He refuses to leave the area. Should you proceed with completing the exposure or not?
2. You have been a radiographer for 5 years when you are sent to a site to take some shots. When you get there and start setting up the shot you realize that the survey instrument that you brought with you is not working. You know that if you went back to your company to get another survey instrument you would waste a lot of time, and you have done the same kind of exposure with the same source quite a few times in your 5-year career. What do you do?
3. You are setting up for a shot. You read your dosimeter and it reads off scale. You take all the necessary surveys and find out that the source is in its safe stored position and there is no abnormal radiation present. What do you do?
4. The radiographer in Figure 16 is inspecting a highway overpass. Discuss how you would set up and post restricted, radiation, and high radiation areas. Where would you maintain surveillance?

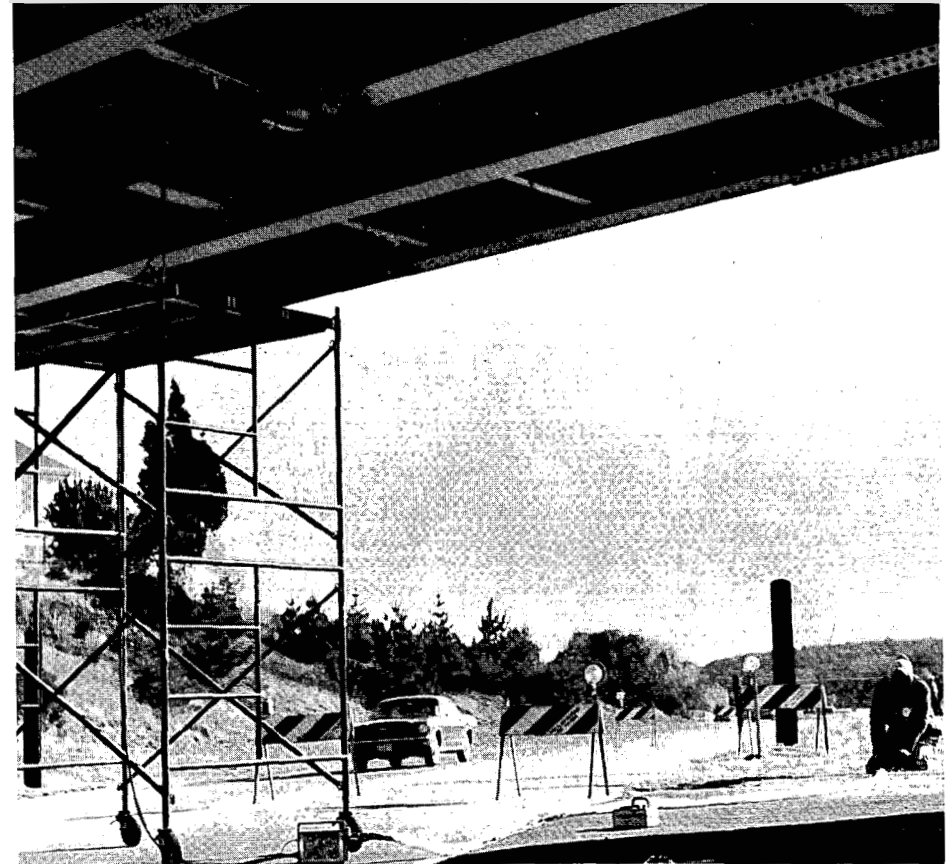

Figure 16. Radiography on a highway overpass.

9

What Are The Rules For Transporting Sources?

Packaging

Moving the Source to the Work Site

Receiving and Shipping Sources



The transportation of radioactive materials is highly regulated. As a radiographer, you will be involved with regulated transportation of radioactive materials every time you take your camera out into the field.*

The U.S. Department of Transportation (DOT) regulates the transportation of radioactive materials between states. The NRC and Agreement States also regulate the transportation of radioactive materials. However, NRC regulations [10 CFR § 71.5] and state regulations require that some DOT regulations be met. So, certain DOT regulations must be met whether the shipment crosses a state line or not.

The DOT regulations for transport of radiography sources are DOT's "Hazardous Materials Regulations," Parts 171 through 179 of Title 49 of the Code of Federal Regulations [49 CFR Parts 171-179]. Your employer's procedures for transporting radiography sources are written to be consistent with federal and state regulations.

Packaging

Radiography sources must be properly packaged for transportation. The proper packaging depends on (1) the amount of radioactivity involved and (2) the form of the material. There are two forms: **special form** and **normal form**.

Special Form and Normal Form [49 CFR § 173.389(a) and § 173.398(a)]

Special form means the radioactive material is contained in a leakproof,

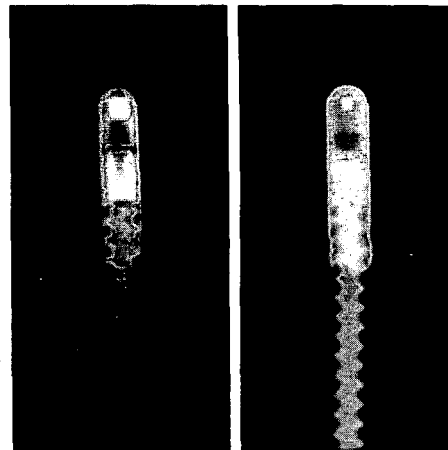

Figure 1. A radiograph of two sources, shown actual size. The radioactive material (white squares) is inside steel capsules. Radiography sources are *special form* because the radioactive material is sealed inside steel capsules.

escape-proof capsule to prevent the spread of radioactive contamination. Radiography sources are special form. A radiography source is encapsulated in a high strength metal such as stainless steel as shown in Figure 1.

Normal form radioactive materials are those in a form that does not give as much protection against escape of the radioactive materials and that does not qualify as special form. Examples of normal form material are glass or plastic vials of radiopharmaceuticals and radioac-

tive waste material such as contaminated towels in plastic bags.

The remainder of this chapter deals only with special form materials since radiography sources are special form.

Amount of Radioactivity in Packages [49 CFR § 173.389]

There are three special kinds of packaging depending on the amount of radioactive material that

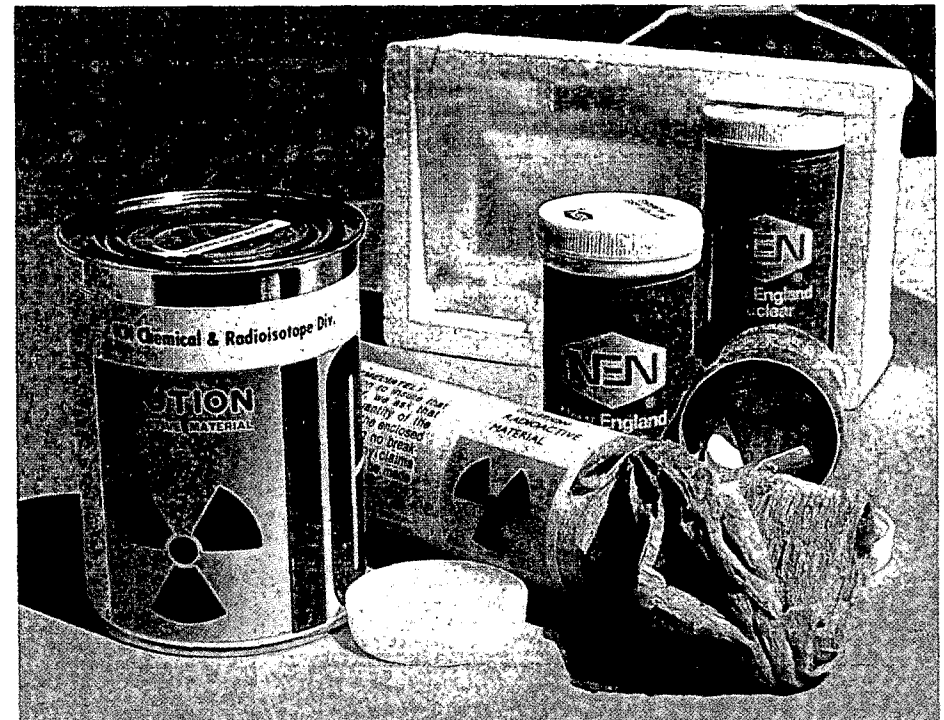

Figure 2. Radioactive materials in *normal form* are often powders or liquids in containers like these. These containers are shipped in outer cartons.

*This chapter is optional. It may be omitted if you are not doing field radiography and if you are not responsible for receiving and sending out shipments of radioactive materials.

they are allowed to contain: **Type A**, **Type B**, and **Large Quantities**. For special form materials, the curie limits are as follows:

Packaging Type	Maximum Radiation Activity
Type A	20* Ci
Type B	5,000 Ci
Large Quantity	No limit

Most radiography sources will require Type B packaging, so we will concentrate our discussion on Type B packaging. Old sources being shipped away for disposal could often be shipped in Type A packaging. But they will usually be shipped in Type B packaging anyway because the shipping containers used to ship out old sources are most often the same containers used to receive new sources.

Type B Packaging [49 CFR § 173.394(b)]

To ship 20 to 5,000 curies of special form material, Type B packaging is required. Type B packaging is designed to withstand certain accident conditions without significant loss of shielding capability.

*The maximum activity of cobalt-60 that can be shipped in a Type A package would be changed to 7 curies if a proposed regulation (*Federal Register*, Volume 44, page 48234, August 17, 1979) is adopted. The Type A package limit for iridium-192 would remain at 20 curies.

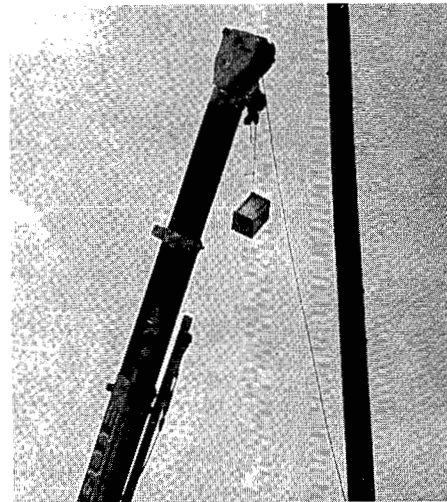

Figure 3. Radiography camera in an overpack being lifted for the 30-foot drop test.

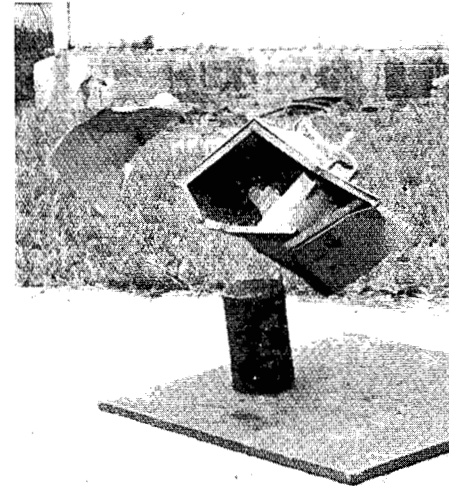

Figure 4. Impact of camera in overpack onto a steel cylinder.

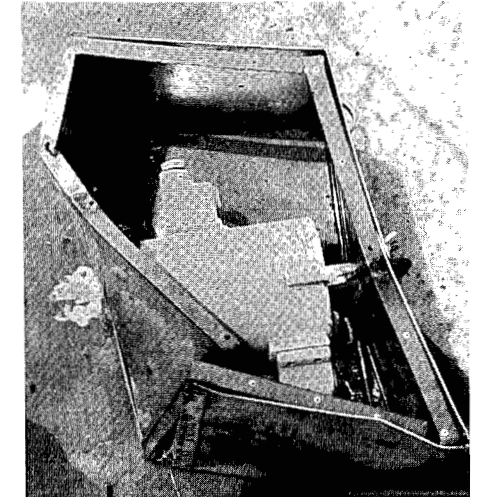
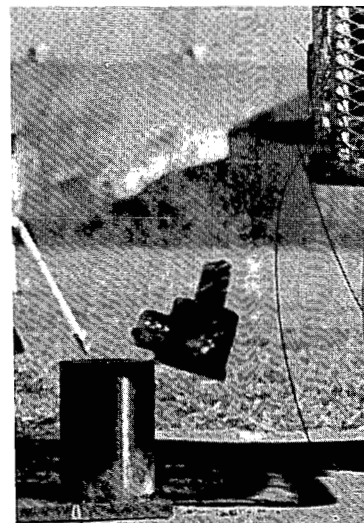
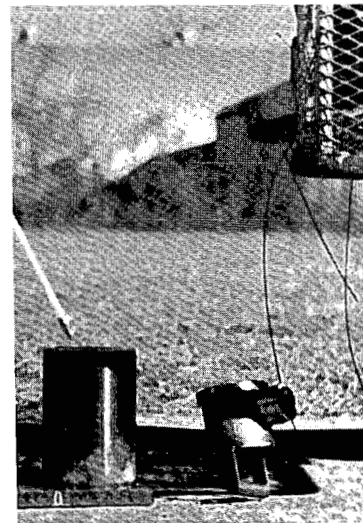

Figure 5. Camera in overpack after the impact. The source remained fully shielded.



Moment of impact



Just after impact

Figure 6. A 40-inch drop onto a 6-inch diameter steel cylinder.

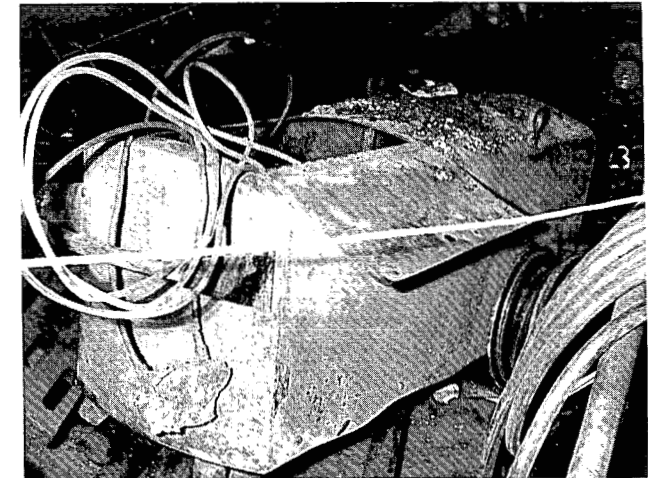

Figure 7. A fire in a factory destroyed this cobalt-60 camera. The tires burned off and the crank melted, but the shielding was undamaged. There was no radiation hazard.

Type B packaging must pass these tests:

1. A 30-foot drop onto a hard surface such as concrete,
2. A 40-inch drop onto a 6-inch diameter steel pin, and
3. A fire of 1475 degrees Fahrenheit for 30 minutes.

The first two tests are illustrated in Figures 3 through 6. Figure 7 shows how a radiography camera survived an actual fire.

Most radiography cameras meet the requirements for Type B packaging. However, some cameras need additional packaging to meet the requirements for Type B packaging or to lower surface radiation dose rates. These cameras must be shipped in an **overpack**. An overpack is an outer package that the camera is put into for additional protection during shipping. Figures 3, 4, and 5 show a radiography camera in an overpack.

Two other overpacks are shown in Figure 8. The container on the left with the raised lid is for shipping cobalt-60 sources. The crate on the right is for shipment of portable iridium-192 cameras.

No radiography source in Type B packaging has ever become unshielded because of a transportation accident. Type B packaging is designed to resist transportation

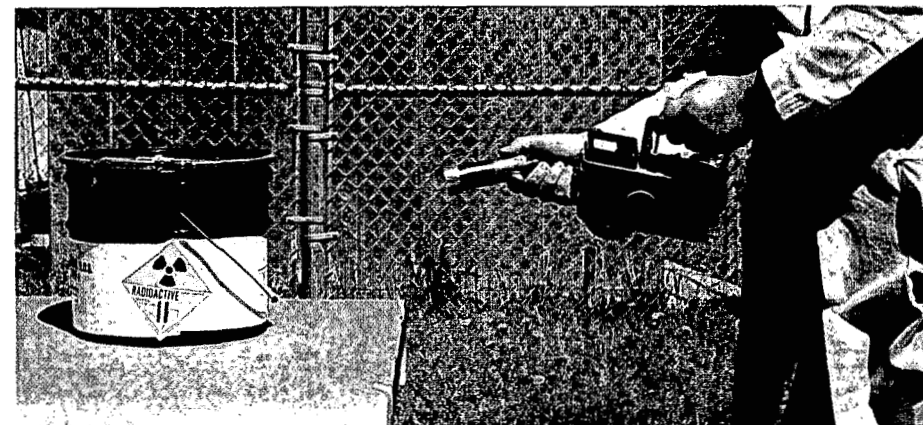
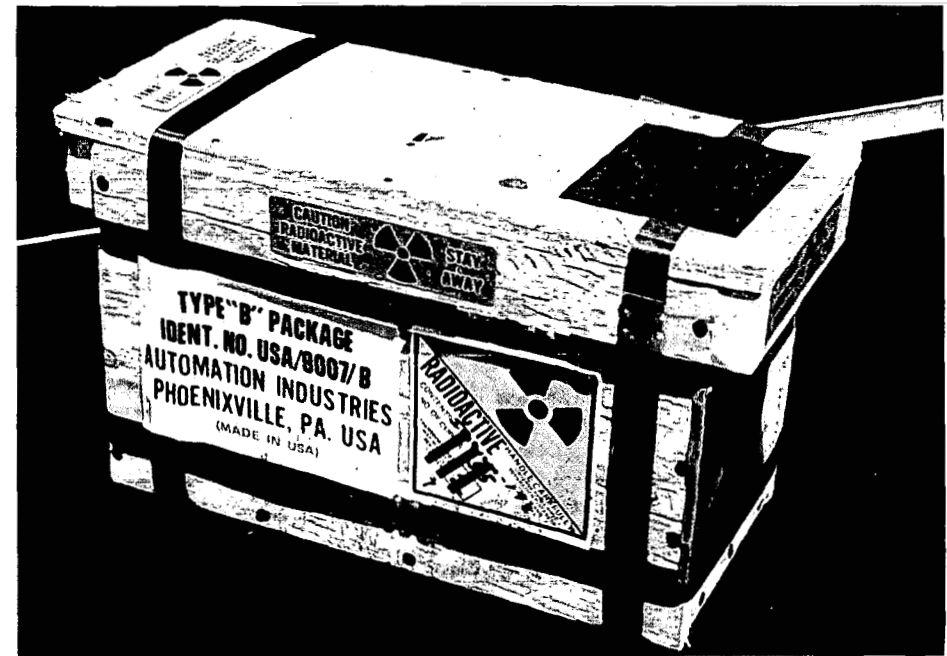
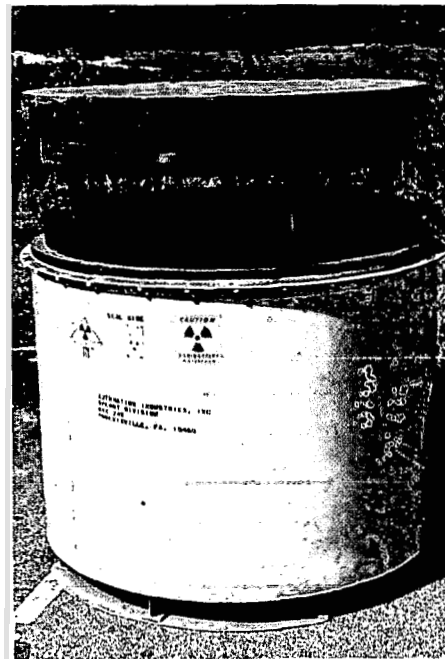

Figure 8. An overpack for cobalt-60 on the left and for an iridium-192 camera on the right.

accidents, and it does. Radiography sources in Type B packaging have not proven to be hazardous in transportation.

Radiation Limits for Packages

Even though the packages for transporting radiography sources contain shields, some gamma radiation will penetrate the package shielding.

Figure 9. A worker measures the transport index of a package.



Figure 10. Radioactive White I warning label on a package.

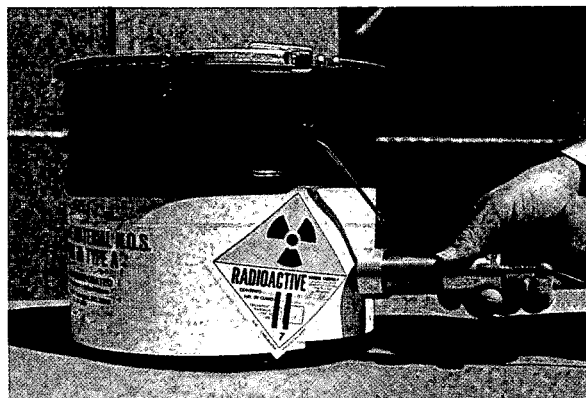

Figure 11. A worker measures the surface dose rate on a package with a Radioactive Yellow II warning label. Note that another kind of label (on the left) shows that this container meets the requirements for Type A packaging.

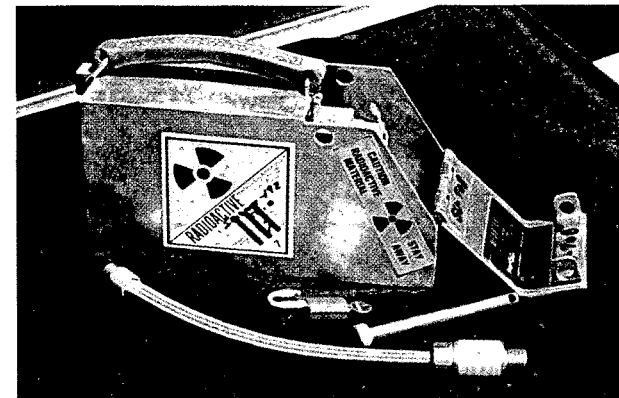

Figure 12. Radioactive Yellow III warning label on a source changer.

In addition to the requirements on how the packaging is made, the DOT regulations have limits on the dose rate at the *surface of a package* and the dose rate at *3 feet from the package*. The dose rate limit at 3 feet from a package is expressed in terms of a **transport index**. The transport index (TI) is the highest dose rate in mR/hr at 3 feet from the package. If the highest dose rate at 3 feet is 5 mR/hr, the transport index is 5.

Warning Labels

Packages containing radioactive materials must be labeled on two opposite sides with **warning labels**. These labels tell what radioactive material is in the package and the

radiation dose rates near the package. There are three types of warning labels, depending on the dose rates.

If the surface dose rate is 0.5 mR/hr or less, **Radioactive White I** labels are used [49 CFR § 172.436]. Figure 10 shows a Radioactive White I label on a package.

Radioactive Yellow II labels are used if the surface dose rate does not exceed 50 mR/hr and the dose rate at 3 feet (the transport index) does not exceed 1 mR/hr [49 CFR § 172.438]. Figure 11 shows a Radioactive Yellow II label on a package.

Radioactive Yellow III labels are used for all packages with a surface dose rate greater than 50 mR/hr or

dose rate at 3 feet (transport index) greater than 1 mR/hr (shown in Figure 12) [49 CFR § 172.440].

The dose rates for the three types of warning labels are summarized below [49 CFR § 172.403]:

Warning label	Maximum dose rate at the surface of the package	Maximum dose rate at 3 ft from the package (transport index)
Radioactive White I	0.5 mR/hr	Not specified
Radioactive Yellow II	50 mR/hr	1.0 mR/hr
Radioactive Yellow III	No maximum limit	No maximum limit

For portable iridium-192 cameras with new sources, the dose rate at the surface usually exceeds 50 mR/hr. Therefore, the camera

will require the Radioactive Yellow III label while being shipped if no outer container is used. As the source decays, the dose rate at the surface will eventually drop below 50 mR/hr and a Radioactive Yellow II label would be acceptable. There is no need to worry about the exact moment when the transition occurs. However, as long as the Radioactive Yellow III label is used during transportation, all the precautions required for this label such as vehicle placarding (discussed below) are necessary.

Trucks carrying radiography sources often have special boxes that the camera is locked in. If the dose rate on the surface of the box is less than 50 mR/hr and is less than 1 mR/hr at 3 feet, a Radioactive Yellow II label can be used.

Cameras containing no source are still radioactive if they use uranium for their shielding. Dose rates at the surface are about 0.5 mR/hr. DOT regulations [49 CFR § 173.391(c)] exempt uranium from labeling if the surface dose rates on the package are below 0.5 mR/hr. Therefore, either no label or the Radioactive Yellow II label may be appropriate depending on exactly what dose rate you read on your survey meter.

Moving the Source to the Work Site

Now that your source is in the proper packaging and the package has the correct label, you are ready to take it to the work site.

If the package requires a Yellow III label, the vehicle in which it is carried must have **placards** [49 CFR § 172.504]. A placard is a sign to show that the vehicle is carrying radioactive material. A truck with placards is shown in Figure 13. Placards must be put on all four sides of the vehicle. Vehicles carrying only White I or Yellow II labeled packages do not need placards.

Placarded trucks carrying radiography cameras should travel to the worksite by the quickest route [49 CFR § 177.825(a)].¹

The radiography cameras must be tied or braced against movement inside the truck [49 CFR § 177.834]. This is to prevent the camera from

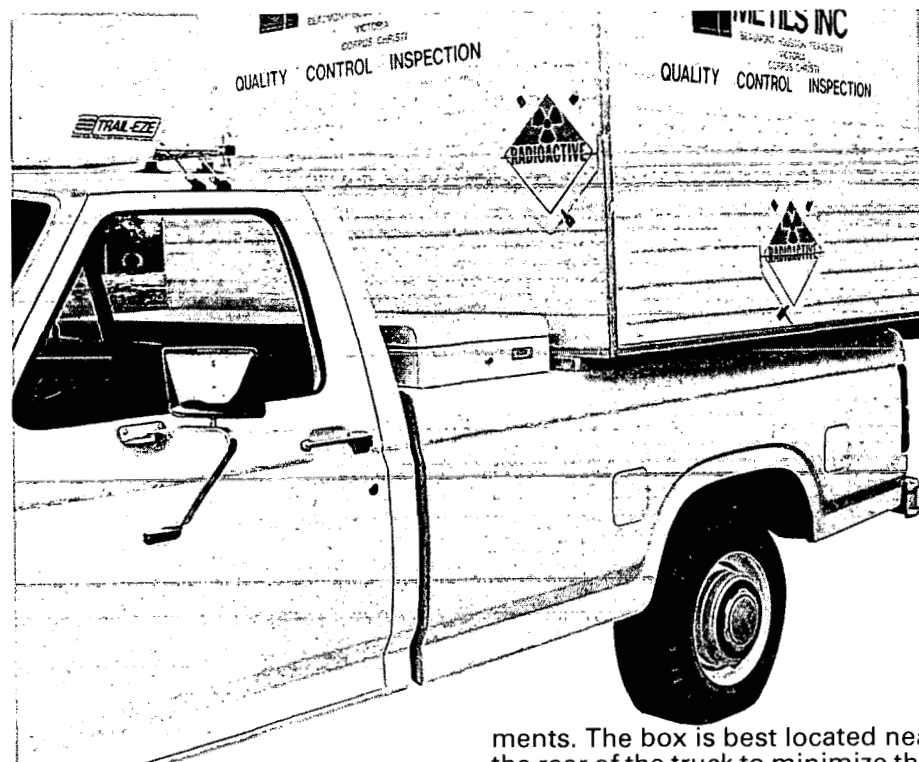

falling out of the truck if the door is left open or some other mishap occurs. If the camera is braced inside a box and the dose rate at the surface of the box is less than 50 mR/hr and less than 1 mR/hr at 3 feet, the box may use a "Radioactive Yellow II" label. Then no placards are needed on the truck nor are there special routing require-

ments. The box is best located near the rear of the truck to minimize the driver's radiation dose. A typical camera* must be located at least 2 feet from where you will be sitting [49 CFR § 177.842(b)].

If you leave your vehicle for some reason (for example, a coffee break), the camera must be locked inside to prevent it from being taken [10 CFR § 20.207 and § 34.23].

*Transport index is assumed to be less than 5 mR/hr at 3 feet.

Figure 13. A truck with placards required by DOT for trucks carrying packages with Radioactive Yellow III warning labels.

The radiation dose rate outside the truck should be measured. The dose rates allowed by DOT regulations outside the truck are higher than would be encountered with a radiography source properly shielded within a camera. But you may want to use the truck as a storage area if you work in the field. If you do, the area outside the truck must meet NRC's regulations for unrestricted areas. Dose rates in unrestricted areas must be below 2 mR/hr or 0.6 mR/hr if you will be in one place for a long time (to meet the 100 mrem in 7-day limit) [10 CFR § 20.105(b)].

A transportation checklist must be completed before you start your trip. Many employers combine this list with the source utilization log required by the NRC [10 CFR § 34.27] because the information required for each is almost identical.

If a traffic accident occurs, make an immediate radiation survey if you are not too injured to do so. You are probably carrying an operable survey meter because you would need one at the job site. If radiation levels are above those expected, follow your emergency procedures. Emergency procedures are discussed in the next chapter (Chapter 10). Your company may be required

to report the accident to the U.S. Department of Transportation [49 CFR § 177.861].

Receiving and Shipping Sources

Receiving a Source*

Radiography sources shipped to your company must be picked up from the carrier promptly [10 CFR § 20.205(a)]. This is so that the carrier's employees are not needlessly exposed to radiation from keeping the source and so that someone does not take the source out of its shielding.

After you pick up the source from the carrier, you must make a radiation survey to make sure that radiation levels do not exceed 200 mR/hr at the surface [10 CFR § 20.205(c)]. Figure 14 shows a radiographer surveying a newly received camera containing a source. He makes sure his meter reads less than 200 mR/hr on all sides of the camera. A record of the survey must be made [10 CFR § 20.401(b)]. Usually your company will have a standard form for recording the receipt of a source. The form will usually ask for the source serial number, model number, isotope



Figure 14. When a radiography source is received, a survey of surface radiation levels and radiation levels at 3 feet must be made. Here the radiographer makes sure his meter reads less than 200 mR/hr on all surfaces. The front of the camera where the source comes out is most important. If the source is not properly shielded, high radiation levels would be found at the front of the camera.

type, and activity. It will also ask for the serial number and model number of the shipping container.

The dose rate at 3 feet must also be measured [§ 20.205(c)]. The dose rate measured should be about the same as the transport index written on the package warning label. The dose rate at 3 feet cannot exceed 10 mR/hr. A record of this survey must also be made [10 CFR § 20.401(b)].

NRC regulations do not require wipe tests for contamination for packages you receive that contain radiography sources because the sources are special form material [10 CFR § 20.205(b)(1)(iii)].

If dose rates exceed 200 mR/hr at the surface or 10 mR/hr at 3 feet, your company must report this to the NRC and the carrier immediately [10 CFR § 20.205(c)(2)].

Shipping a Source

Before you deliver a radiography source to a commercial carrier, the most important thing to do is to make sure the source is securely locked in the fully shielded position. You do this by making a radiation survey of the shipping container and by checking to see that the source is locked in the shielded position. This will prevent cargo handlers and others from being exposed to an intense beam of radiation from the source.

Now that you have surveyed and checked the lock to make sure the source is locked in the fully shielded position, you must attach a security seal with an identification

mark on the package [49 CFR § 173.393(b)]. The security seal lets the person receiving the package know that the source has not been tampered with.

Apply the proper warning labels to two sides of the package [49 CFR § 172.403(f)]. (The warning labels were shown in Figures 10-12.) Most spent (used) sources will use a Radioactive Yellow II label because the surface dose rates will be less than 50 mR/hr and the dose rate at 3 feet will be less than 1 mR/hr. Figure 15 shows a properly labeled container with Radioactive Yellow III labels filled out. The lock and security seal are also visible. Remove any old warning labels from the package so that it does not have confusing or contradictory labels.

Mark the outside of the package: "Radioactive material, Special form, N.O.S." [49 CFR § 172.300]. This was shown in Figure 13 in Chapter 5. (N.O.S. means "not otherwise specified.") If the package weighs more than 110 pounds, write its weight on the package [49 CFR § 172.310(a)].

If a shipping container is packaged inside a crate or other packaging, mark the outside package, "Inside container in accordance with _____" (in the blank put the DOT Specification Number or Type B Certificate Number). Also indicate the appropriate type of package ("Type B" or "Type A") [49 CFR § 172.310 and 49 CFR § 173.393(a)].

*Note: We assume the radiography source requires Type B packaging and that it will be shipped by a common carrier in a vehicle that will carry many different packages from different shippers (DOT calls this a **non-exclusive-use vehicle**).

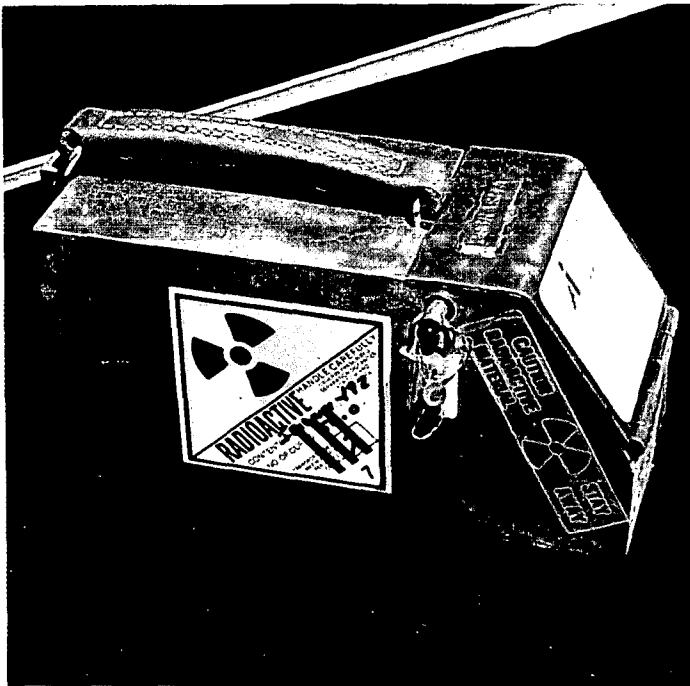

Figure 15. Radiography source changer ready for shipment.

Fill out the shipping papers. This will include:

- "Radioactive material, special form, N.O.S."
- Type of radioactive material ("iridium-192" or "cobalt-60")
- "Special form"
- Number of curies
- Type of warning label (such as "Radioactive Yellow II")
- Transport index
- NRC identification number or DOT specification number.

You must also certify that the shipment is properly classified (such as Radioactive Yellow II), described, packaged, marked, and labeled [49 CFR § 172.204(a)].

For air shipment, radiography sources can only be shipped on cargo aircraft. Years ago radiography sources were permitted on passenger aircraft. The change happened because, in 1974, a radiography camera was shipped in a passenger aircraft with the source not fully shielded.² The receivers discovered and reported the condition. The passengers and crew on the aircraft were exposed to radiation from the source. Because of this accident, Congress banned the shipment of radiography sources from passenger aircraft.

Air shipments must be labeled "Cargo Aircraft Only" [49 CFR § 172.402(b)] and the shipping papers must state, "This shipment is within the limitations prescribed for cargo-only aircraft."

Questions

- | | | |
|--|---|---|
| 1. Radiography sources are: | (a) Special form radioactive material
(b) Normal form radioactive material | (c) Safe radioactive material |
| 2. The "transport index" refers to: | (a) The surface dose rate of a package containing radioactive material.
(b) The highest dose rate at 3 feet from the surface of a package containing radioactive material. | (c) The dose rate at the surface of a truck carrying packages containing radioactive material.
(d) The dose rate in the driver's compartment of a truck carrying packages containing radioactive material. |
| 3. The type of distinctive warning label that must be applied to the surface of a package containing radioactive material is determined by: | (a) The highest dose rate at the surface and at 3 feet from the surface of the package.
(b) The weight of the material. | (c) The transport index.
(d) The type of vehicle in which the package will be shipped. |
| 4. A Radioactive Yellow II warning label is applied to packages with a transport index of: | (a) 0
(b) Between 0 and 1. | (c) Between 1 and 10.
(d) Between 10 and 100. |
| 5. A package contains radioactive material. The highest dose rate at the surface is 25 mR/hr and the highest dose rate at 3 feet from the surface is 2.5 mR/hr. The proper radioactive warning label to apply on two opposite sides of the package would be: | (a) A Radioactive Yellow III label.
(b) A Radioactive Yellow II label. | (c) A Radioactive White I label.
(d) No label is required; the dose rate is too low. |
| 6. Any vehicle carrying radioactive material must be placarded. True or False? | | |
| 7. Any vehicle carrying a package containing radioactive material that has a Radioactive Yellow III | warning label needs to be placarded on all four sides. True or False? | |
| 8. What are the basic steps you should take before transporting a radiography source? | | |

10

How Can Following Procedures Help You?

Operating Procedures

Emergency Procedures



Your employer provides you with a set of specific operating and emergency procedures for performing radiography for your company. These procedures will vary from company to company to allow for the differences in the work performed and the needs of the company. It is very important to follow these procedures to avoid excessive exposure to radiation. Most overexposure accidents can be related to failure of the radiographer to follow procedures.

Operating Procedures

A great deal of your job is routine, hard work. You may be tempted to take shortcuts. Don't. Your company's operating procedures are the result of many years of experience in the radiography field. Every step is there for a reason. Radiation cannot be seen, heard, or felt. If you are not following your company's procedures, you may not know that something is wrong until it's too late.

Your company's procedures are the commitment your company makes to safety. Sometimes these procedures may seem to be time consuming, but your company has carefully considered what steps are needed to work safely. The steps in the procedures have reasons behind them based on years of experience working with radiography sources.

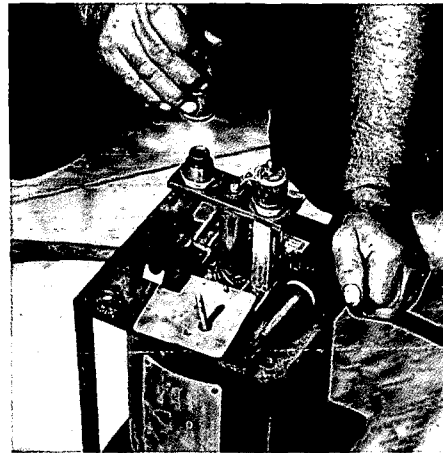

1) The radiographer connects a guide tube the source changer.

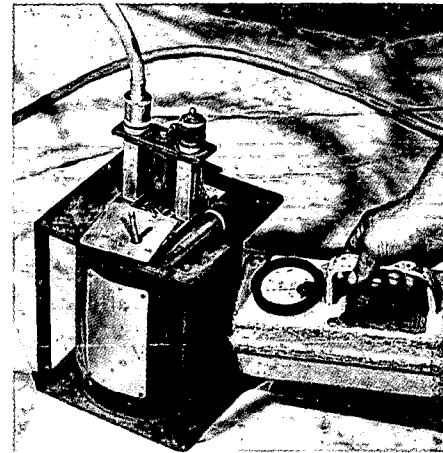

3) After the source has been transferred into the changer, the radiographer surveys both the camera and the changer to make sure the source is shielded within the changer.

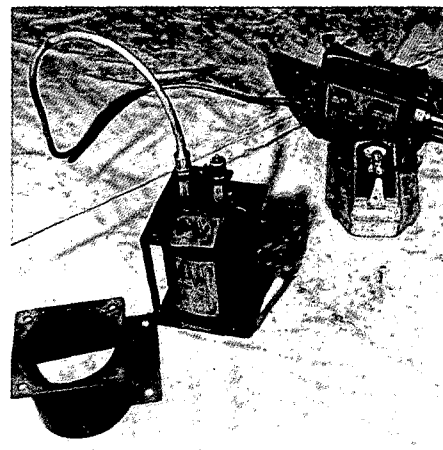

2) The equipment is ready. The radiographer can crank the source out of the camera into the source changer.



4) Now the radiographer disconnects the drive cable from the source pigtail.

Figure 1. Operating procedures give you step-by-step instructions for your work. Major steps in transferring an old source from a camera to a source changer are illustrated here.

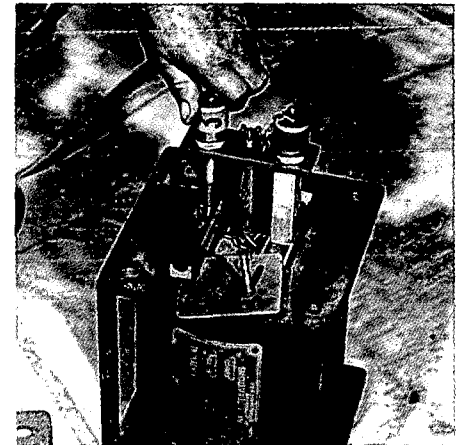

5) He inserts a plunger against the pigtail to lock the source in place.

Emergency Procedures

In an emergency situation, something has gone wrong in some unpredictable manner. You must act to eliminate any danger that exists. You will have to make judgments (and often in a short span of time). To help you make sound judgments in these unforeseen situations, your employer provides you with general rules on what to do. These are your **emergency procedures**. Your employer is most familiar with the types of jobs you do and the equipment you work with. Your employer also knows what training you've had and what your capabilities are.

However, even these written emergency procedures are not likely to be able to tell you *exactly* how to handle a particular emergency. Emergency situations are just too unpredictable. For example, the Norfolk Naval Shipyard, as part of their training program, periodically held emergency drills. Their practical experience during these drills was that many situations contained some peculiarity that made it impossible or hazardous to follow their emergency procedures.¹ Sound judgment was usually necessary to improvise a procedure that would work safely in a particular situation. It is to the credit of radiographers that experienced radiographers have usually handled emergencies safely once they have been recognized.²

This instruction manual does not train you in your employer's specific emergency procedures. Your company must provide that training separately. However, we want to discuss some general aspects of responding to emergencies.

Recognizing the Emergency

An emergency situation must be recognized before any suitable response can be made. Sometimes recognizing a problem is easy. If you see the source guide tube crushed by a piece of heavy equipment and you cannot retract the source, you know you have a problem.

Sometimes emergencies may not be immediately recognized. A source can disconnect in the guide tube without your knowledge. Illness or fatigue may impair your ability to work properly without your being aware of what is happening. Serious distractions can confuse you and lead you to make errors.

The *first step* is to recognize that a dangerous situation exists. Recognize the conditions that mean a "warning sign." These will provide a signal to alert you to what could be a dangerous situation. By learning what situations have caused accidents in the past, you may be able to avoid an accident if you are in the same situation yourself some day. In the next chapter, we will discuss some accidents that started without the radiographer knowing that anything was going wrong.

Following Procedures

The Immediate Response

What should you do if a source is exposed? Once you have recognized that an emergency exists, there is usually plenty of time to make a correct judgment.

First, move away from the exposed source and keep other people away. Just a few yards reduces radiation levels considerably. For a 100-curie iridium-192 source, moving just 10 or 15 feet away reduces the radiation level to roughly 4 rem/hour. The worst thing you can do is to touch the source with your hand. Don't try to put the source back into the camera by hand or reconnect it to the drive cable by hand. Touching a 100-curie iridium-192 source causes radiation burns in seconds.

Second, *relax, remain calm, don't panic, and think*. When you are a few yards away from the source, you have time to think about what to do. Don't panic if the source cannot be immediately shielded.

Third, establish a restricted area, and make sure no one approaches the source. Rope off the area, if possible, if this has not already been done. Use your survey meter to make sure the restricted area has been properly roped off.

Fourth, call for help, but don't leave an exposed source unattended. If there is no one there to help, you should remain in the area if possible, but not too close to the source. Sooner or later someone will come along. *Don't try to do anything yourself that you are not trained to do.*

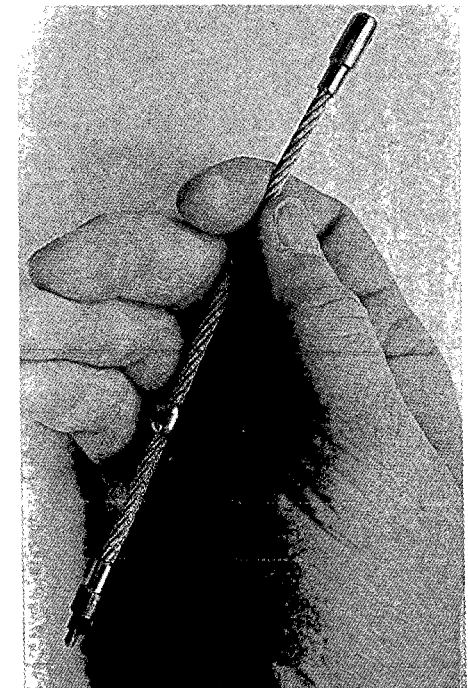
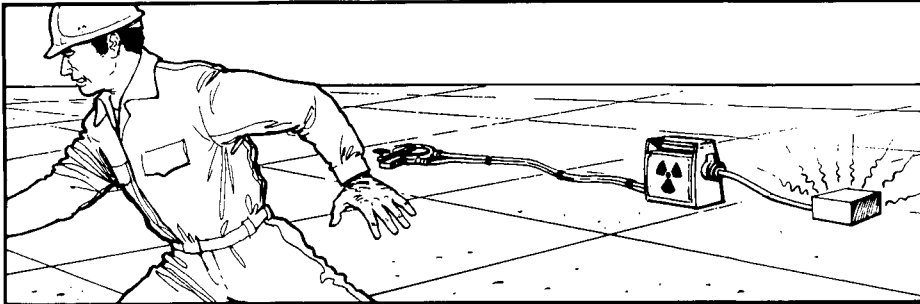
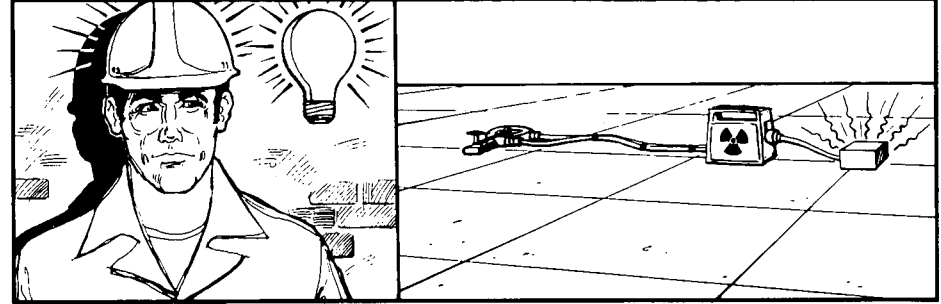

Figure 2. The worst thing you can do is hold a source like this. The dose rate on the surface of the source capsule can cause radiation burns in seconds. Of course, a dummy source was used for this picture.

1. Move Away from Source at Once



2. Calm Down and Think



3. Establish Restricted Area

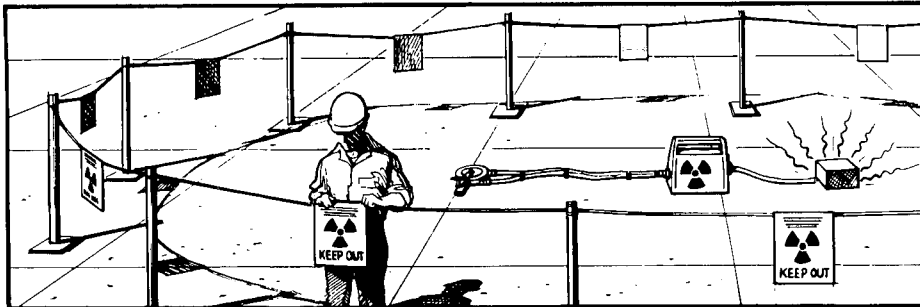

4. Call for Help



Figure 3. How to deal with an exposed source.

To get the help you need, you will frequently have to call for the help of others. For any emergency, you must know whom you are supposed to call for help. A common requirement of emergency procedures is that you should contact your employer's **radiation safety officer (RSO)** for help.

If the police are contacted, it is important for you to offer them as much information and assistance as you can. You will usually have the most knowledge of the situation, and you will be a key person for others to talk to.

Group Discussion

The situations below are meant to be discussed in a class of people training to be radiographers. In most instances, the students will have to invent additional information to fully describe the situations. There are many different ways to handle these situations safely. There is more than *one* correct way.

1. You are at your lunch break when another radiographer, who is a friend of yours, approaches you and asks you if he could use your film badge. He says he has to make some exposures and does not have his with him. Discuss what you would do.
2. You are a radiographer's assistant in training at a field site under the supervision of an experienced radiographer. After a few exposures, you notice that your dosimeter reads about half scale (approximately 100 mR), and you bring that to the attention of the radiographer. He assures you that there is no problem and tells you to get back to work. Discuss what you should do.
3. You are setting up an exposure at a site when you find out that your survey meter is not working. This is a common radiography shot that you have performed many times in your career as a radiographer. Should you go ahead with the shot, based on previous experience, or not? Discuss how you would handle this situation.
4. You have just finished an exposure and are trying to retract the source when you realize that it is stuck. Discuss what you would do.
5. You are working in a permanent radiography cell equipped with a radiation alarm. The alarm goes off with no source being exposed, and you are able to determine that the alarm is malfunctioning. There is no one on site available at this time to repair the alarm so you are left with two options: (a) turn the power to the alarm off and continue your work using your survey meter, or (b) don't take any more shots until the alarm has been repaired. What would you do?
6. It is early afternoon. You have just charged your pocket dosimeter and you are setting up for a shot. You take a survey prior to the exposure of the source and your survey meter shows everything is fine. But when you check your dosimeter, it reads off scale. Would you assume your dosimeter is malfunctioning and proceed with the shot? Or would you assume your survey meter is inoperable and try to get another one before completing the shot? What would you do?
7. You are working by yourself. In the middle of a shot, you get dizzy and collapse. A few minutes later you feel somewhat better. Should you continue your work?

8. A crane has just rolled over the crank of your camera while the source is out. The crank assembly looks like the one in Figure 4. What do you do?

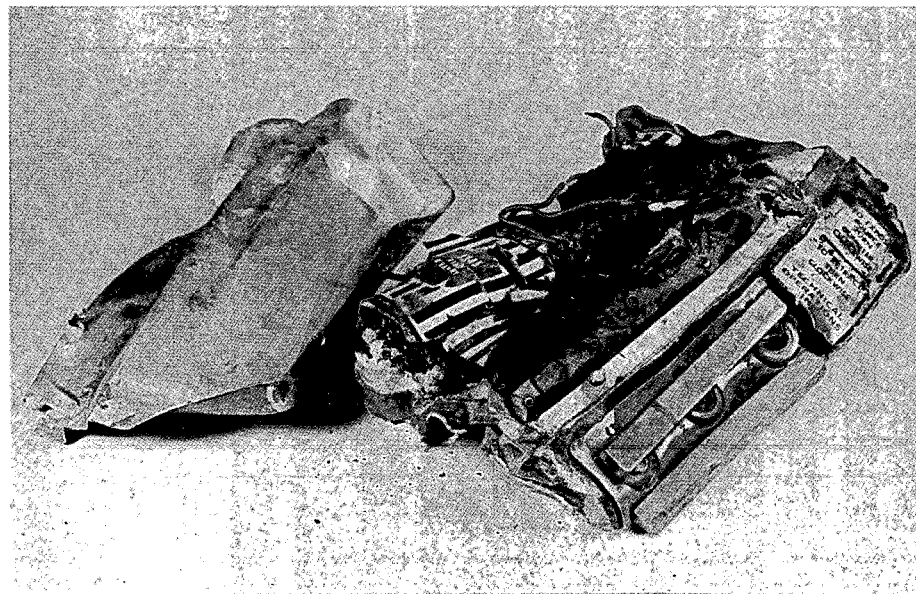
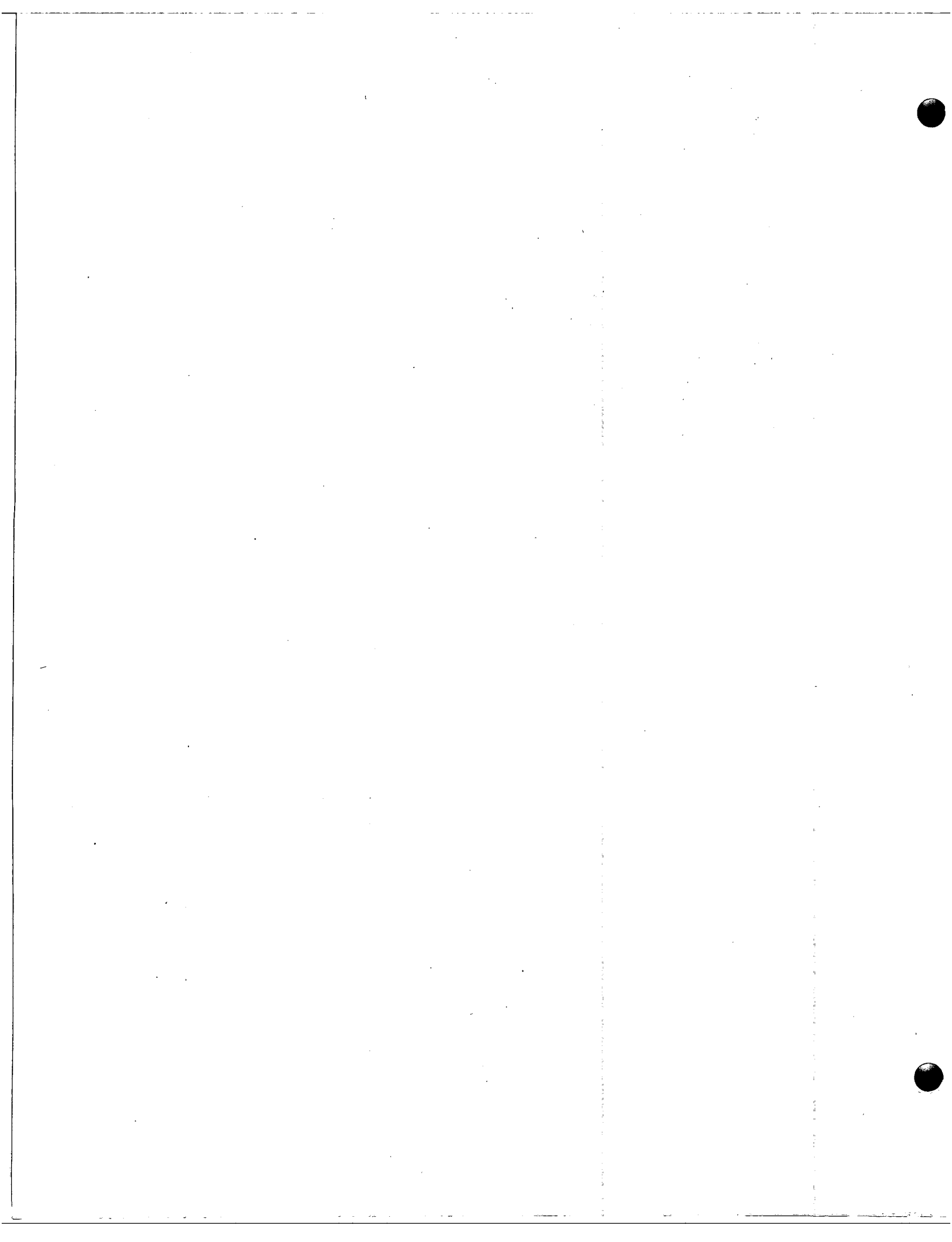

Figure 4. A crank assembly run over by a crane.

Why Do Radiography Accidents Happen?

How Radiography Accidents Happen

But Why?



Throughout this radiography manual we have talked about radiation overexposures and how to avoid them. Why are we so concerned about overexposure accidents?

The reason is that industrial radiographers suffer a major portion of the overexposures among workers employed by NRC licensees. For example, in the 10-year period from 1971 to 1980 about 600 overexposures were reported by all NRC licensees (see Appendix F, Table 1). Of these, about one-quarter were received by radiographers even though they make up only a few percent of the people working with radiation at NRC-licensed activities.

The figures for serious overexposures are even more striking. We consider a serious overexposure to be a dose greater than 25 rems given to the entire body or over 375 rems to a portion of the body such as the hands. These doses are just below the dose levels where physical symptoms would be evident shortly after the overexposure. During the 10 years 1971 to 1980, there were 21 overexposures reported that exceeded these doses. Of these 21, 15 were received by radiographers. This means radiographers suffered over 70% of the most serious overexposures reported by NRC licensees. A few of these serious overexposures caused permanent harm to the people exposed.

This is not to say that the record of gamma radiography is poor. Radiography sources are potentially very dangerous. They are used tens of millions of times a year by thousands of people. In comparison to the opportunities for accidents, the accidents are very rare. In Chapter 4, we concluded that gamma radiography is safer than most types of industrial work. Still, severe overexposure accidents sometimes do happen.

How Radiography Accidents Happen

Radiography accidents usually happen because of the following failures. First, the radiographer does not return the source to the fully shielded position, which leaves the source exposed. Second, the radiographer omits the radiation survey or does not survey adequately. Third, in some cases, the radiographer does not use the locking ring or plunger to secure the source in its shielded position.

A Source Is Left Exposed

Why are sources left exposed when they should not be? To answer this question we looked at the 48 most serious radiography accidents reported to the NRC from 1971 to 1980. The accidents are listed in Appendix F, Table 2.

The most common event was having the source near the entrance to the S-tube of the camera (Figure 1). This happened in about one-quarter of the accidents. Why this happened is not clear. However, we can list several possibilities:

- The source caught or hung up on the joint between the guide tube and the camera.
- The source was fully cranked in but the crank handle jumped back half a turn after the ballstop hit its stop.
- Tension in the control cables in some way caused the source to be pushed out.
- A sharp bend in the guide tube near the camera caused the source to get stuck.

The second most common event was forgetting to retract the source. From what is known about the frequency that humans make an error like omitting one step in a process, the performance of radiographers in remembering to retract the source is quite good. However, because of the serious consequences, this type of accident is still of concern.

The third most common event is when the source jams somewhere in the guide tube. This can happen if some heavy object crushes the guide tube or if the guide tube is bent too sharply. Rigid guide tubes (used for special purposes) have

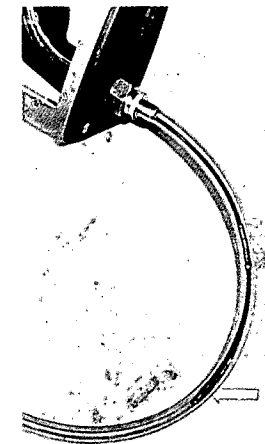

Figure 1. A dummy camera with transparent sides and guide tube is used here to show the position of an incompletely retracted source. The arrow shows the location of a source near the entrance to the S-tube. While disconnecting the guide tube, you can experience a particularly severe overexposure to your hands because they will be so close to the source.

kinked when bent. The kinks have caused sources to jam.

In 3 of the 48 accidents, a source disconnected from the control cable. This can happen if the source is not connected properly in the beginning. It can also happen if the cable breaks or the connector is worn.

In three cases at permanent radiographic installations, two sets of controls for two sources were present. Instead of cranking in the source they were working with, the radiographers cranked out the other source. Now two sources were exposed. The radiographers conducted surveys but could not understand why cranking their sources in and out did not lower the radiation level. They assumed the survey meter was broken and continued their work. Overexposures resulted.

There have been a few other causes for the source being out. Radiographers have confused "in" and "out" while fatigued or distracted. Also, in a few cases, sources have been intentionally exposed by disgruntled workers.

The Omitted Survey

An exposed source will be discovered quickly if the required radiation survey is done and done properly. If the exposed source is detected, an overexposure is unlikely. But in about half of the serious overexposures reported to the NRC between 1971-1980, no radiation survey was attempted (see Appendix F, Table 2). It is difficult to know exactly how often radiographers omit surveys. We estimate that radiographers survey 80% to 90% of the time after the source is retracted.¹ Radiography overexposures usually happen during the 10% to 20% of the time that sur-

veys are not made or are not made correctly.

An overexposure can still happen if you conduct a survey but don't survey properly. This is easy to do if the source is located at the entrance to the S-tube in the camera. When the camera is approached from the back, radiation levels will be near normal because the shielding in the camera will shield the radiation (Figure 2).

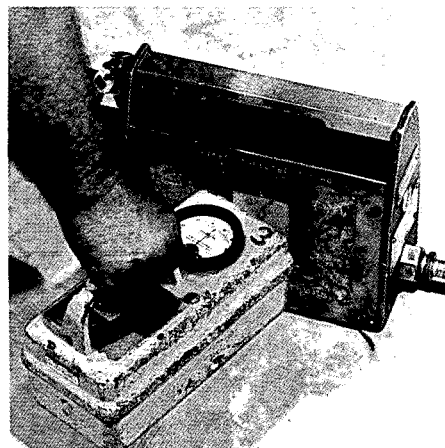

Figure 2. When the source is at the entrance to the S-tube, a survey meter at the rear or side of the camera may have a nearly normal reading.

Similarly, a survey meter left on the ground next to the camera may not detect a source at the entrance of the S-tube. A radiographer who makes a survey that does not include surveying the front of the camera may not discover a source at the entrance of the S-tube.

Broken survey meters contributed to two of the overexposures. At times, a zero reading has led the radiographer to think mistakenly that the source was in its shield. Your survey meter should *not* read zero near the side of a camera. You should know what to do if you get an unusual reading like this on your survey meter.

There have been overexposures where the radiographers thought the survey meter was malfunctioning because it was reading too high, but the real reason the meter was reading high was because the source was exposed. As many overexposures have occurred when the radiographer *did not believe* a high reading on the survey meter as when a meter was broken and did not respond to radiation.

In normal situations, most radiographers know what to do. Difficulty arises, however, when unusual or unexpected things happen. In Chapter 6 we discussed how you can check a survey meter in the field if it starts to behave abnormally. Although abnormal survey meter readings don't happen very often, you should prepare yourself to deal with an unusual situation.

Your safety may depend on how well you handle an unexpected situation.

Not Locking the Camera

Many cameras in use today cannot be locked unless the source is in the fully shielded position (Figures 3 and 4). A quick motion to push in a plunger or rotate a locking ring will tell you for sure whether the source is in its fully shielded position. This is a third level of protection. First, you crank in the source, noticing whether the feel of the cranking is normal. Second, you use your survey meter to ensure that the source is properly shielded. Third, you lock the source in its shielded position. Difficulty in using the locking mechanism may mean that the source is exposed.

In addition, locking the source in position guarantees that the source cannot slip out of the shielded position later. In several instances, radiographers have moved cameras that were not locked. The source moved out of its shield and exposed them.



Figure 3. You cannot rotate the locking ring on this camera to lock it if the source is not in the fully shielded position.

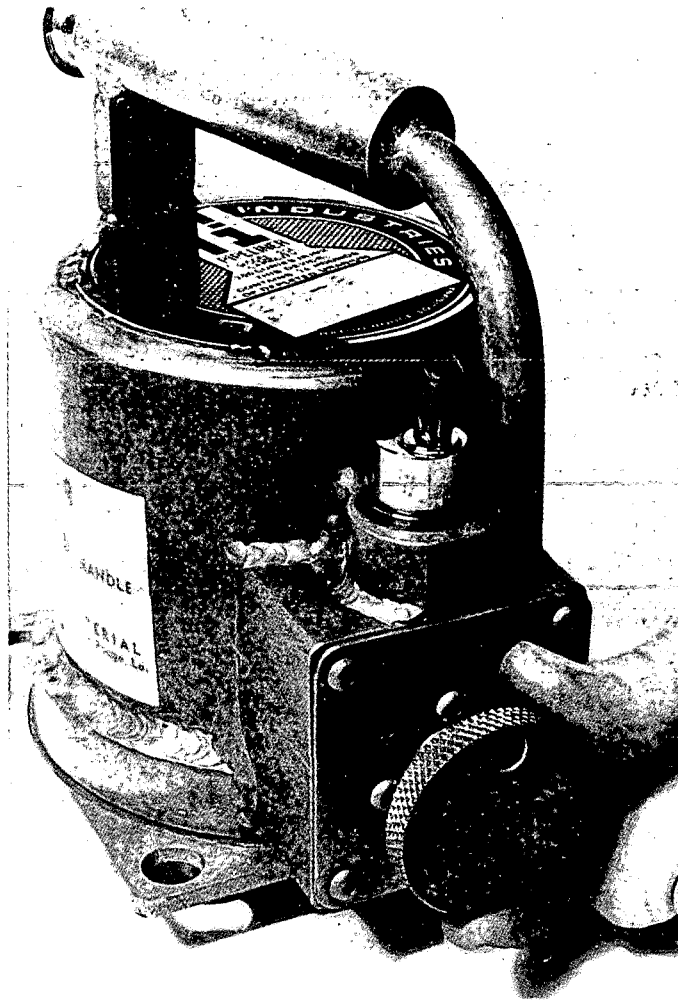

Figure 4. You cannot push in the plunger in this camera if the source is not in the fully shielded position.

But Why?

So far we have told you what happens. But we have not told you *why*. *Why* does a radiographer forget to retract a source? *Why* doesn't a radiographer survey? *Why* doesn't a radiographer lock in the source?

In many accidents, it is not possible to answer these questions. The reports written about radiography accidents often do not deal with why the radiographer did what he did because the radiographer's motivations cannot be positively known. Often the radiographer really does not know or will not tell. But by looking at accidents that have happened and by drawing on knowledge about how accidents happen, we can put together a picture of why radiography accidents happen.

First, let's discuss equipment failure. Considering the 48 accidents mentioned earlier, there did not seem to be any cases where a camera failed that was properly operated and maintained. In the large majority of cases, there was no equipment failure at all. In no case did equipment failure cause an overexposure itself without some errors on the part of the radiographer. Even in those cases where there was some equipment failure, the failure could be traced to some error on the part of the radiographer in operating the equipment, or the equipment was not properly maintained or repaired when damaged. In short, equipment failures

do not play a leading role in radiography overexposures.

Second, let's discuss training. Poor training is often blamed for radiography accidents. If an accident happens when a radiographer does not survey, this is sometimes seen as a training failure. However, sending the radiographer for refresher training on the importance of making surveys may not be the answer. If the radiographer already knew he was supposed to survey, this training would avoid dealing with the real problems that may exist.

In the 48 accidents studied, it was rare for the radiographer to be completely untrained. In some cases, however, the radiographer did not react properly to unusual situations. Overall, we can say that better training, especially on how to deal with unusual situations, would have reduced the number of overexposure accidents. However, usually there were other factors involved as well.

A Case History

Where then do we look to understand what has been happening? Let's start with the case we discussed in Chapter 4, when a factory worker in California got a radiation burn from a source left behind by a radiographer.

The radiographer involved had 32 years of experience, had an excellent record, and was the radiation safety officer for his company. How did he end up dropping a source and leaving it behind? He does not say and we do not know. But let's look at some of the things that were involved. A doctor who examined the radiographer after the accident found he had severe anemia. The doctor thought the condition to be so severe that the man could not perform reliably. The radiographer disagreed. He said he felt fine.

What else happened? The radiographer was working in a shop during lunch hour, but the work was taking longer than he had expected. The shop workers had finished lunch and were banging on the door and shouting to be let in. The radiographer attempted to disconnect the control cable from the source and disconnect the guide tube at the same time. In order to disconnect the source pigtail, he had to crank out the drive cable to enable the drive cable connector to clear the sheath.

Working quickly, he probably cranked the source assembly out of the camera after the guide tube had been removed. The source assembly was attached with a hook-and-eye connector (Figure 5). Once out of the camera, the assembly was free to swing down and drop off. Since he was working quickly and using only one hand to disconnect the source, he probably did not no-

tice that the source was already disconnected when he thought he was disconnecting it from the drive cable.

The radiographer says he conducted a survey, but if he did, he did not pay attention to what the survey meter was telling him.

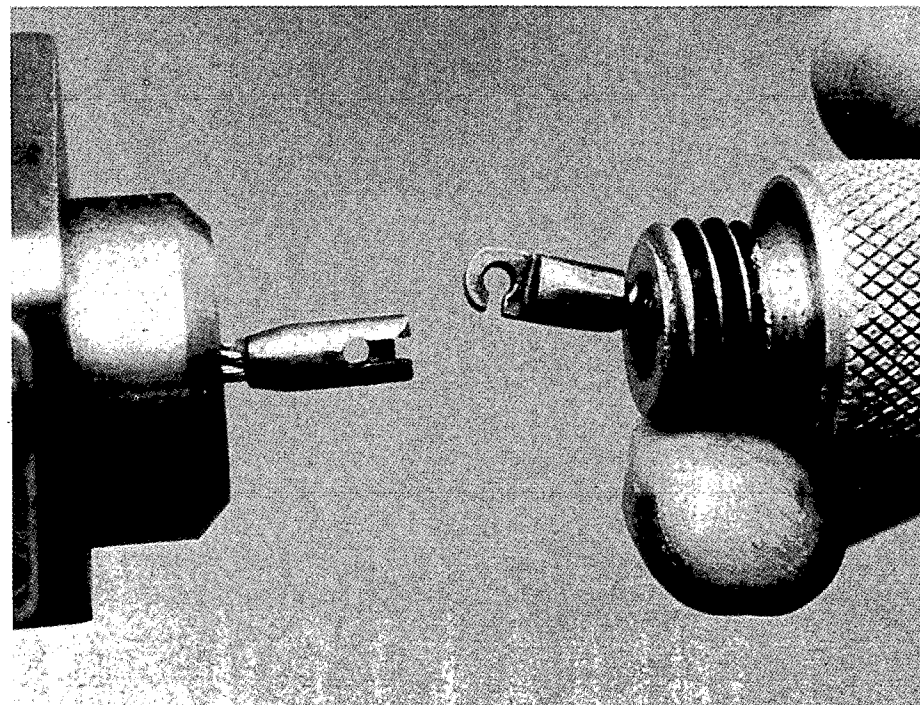

Figure 5. The hook-and-eye connector in the California case.

Hours later the radiographer returned to the shop after he had been called and told he had left something behind. The radiographer told the shop workers that the source they had found was not radioactive and not dangerous.

Why did the radiographer make the mistakes that he did? Perhaps a combination of poor health, of which he was not even aware, and being hurried by the workers wanting to be let in caused the radiographer to rush, become distracted, and not pay attention to what he was doing.

Some Other Examples

In Chapter 4, we also showed radiation burns on the hands of a radiographer. That radiographer confused "in" with "out," so that the source was out whenever he moved the guide tube. This reversal error is a common type of error. Also the radiographer did not make a survey. But why did he make these mistakes? In this case, the radiographer was working at night, he said he was tired, and he said he was in a hurry.

A radiographer in Massachusetts got sick during work. He stopped work, loaded the camera into his truck without making a survey, and drove home. The next day he found out that he had left the source exposed.

In Virginia, an experienced radiographer with an excellent safety record came in to work overtime on Sunday morning. The radiographer propped open the door to the exposure room because the room was too hot to work in. But in order to do this, he had to disconnect the alarm system. He did his work without a film badge or pocket dosimeter and without making surveys. He forgot to retract the source after an exposure and got overexposed. A company manager concluded that the man was probably distracted because he was thinking about his wife, who was at that time in the hospital giving birth to a baby in a difficult delivery.

In another case, the work was being performed just after midnight. The work load that week had been heavy and things were "hectic" at times. Just prior to completion of the shot the radiographer was paged on the intercom, but he wanted to complete the shot before responding. The radiographer was paged again, and this time recognized that the call was from his supervisor. He thought there was a problem with his earlier shots and was concerned about getting to a phone to see what the problem was. In his hurry he did not survey carefully and he twisted the camera locking ring, but not sufficiently. The assistant radiographer was exposed after the radiographer went to answer the page.

The Human Factor

Overall, what can we conclude? Overexposures happen when the source is left out and a radiation survey is not made or is not made correctly. Occasionally equipment does not operate as expected. Occasionally the people involved are not sufficiently trained, especially for dealing with an unusual situation. But usually their training is reasonably adequate.

These accidents seem to happen when the radiographer is under stress or cannot concentrate on his work. The reason may be that he is tired, sick, worried about something, in a great hurry, or thinking about other things. Many studies have shown that accidents are more probable after violent quarrels or after family trouble or stress.

Be alert to the known warning signs of too much stress that can lead to mistakes — and accidents: irritability, hyperexcitation, depression, excessive drinking, "prima donna" behavior, pounding of the heart, impulsiveness, the urge to cry or run and hide, inability to concentrate, feeling of unreality, fatigue, fear of nothing in particular, trembling or nervous tics, high-pitched nervous laughter, insomnia, inability to sit still, nightmares, and being accident-prone.

Too little stress can also lead to accidents. If people are either not stimulated or overly stimulated, their performance is likely to suffer and more accidents will result. If your job is going at an unusually slow pace, if you are unusually sleepy, or if there is little incentive for you to produce, your alertness will be low and your performance may be impaired.

These are the personal factors so often involved when an accident happens.

If you are under stress or cannot concentrate on your work, try to change the situation. Take a break or ask your supervisor and co-workers for help. Recognize any unusual circumstances that might cause you to have an accident. Then, take special care to follow correct procedures.

Remember also that you will believe what you want to believe. At the times when you least want the source to be out, you will ignore the signs that it is out. We see this in case after case. A worker hears an alarm and assumes that the alarm is malfunctioning rather than that the source is exposed. A high meter reading is taken to mean that the meter is malfunctioning. Audible-alarm dosimeters are not heard. Failure to be able to turn a locking ring means the locking ring is broken. If any of these events occurs, expect the worst. Until you have the situation under control,

you are in danger of an overexposure to radiation.

Think about the case of a radiographer working in wet fly ash. His survey meter needle read off scale, but an audible speaker was silent. He cranked and recranked in the source as hard as he could, but could not lock the camera. He concluded that the wet fly ash had shorted his survey meter causing the needle to go off scale and had jammed the locking mechanism. Actually, the meter and locking mechanism were working. The wet fly ash had jammed the crank, preventing the source's return fully into the camera, and had shorted out the audible speaker. We all believe what we want to believe. If our eyes see differently, we ignore what they tell us.

When the last thing in the world that you want to think about is the radiography source, that's when the accident is going to happen.

Group Discussion

In this manual, we have talked about your responsibility to protect yourself and others from being exposed to a radiography source.

1. In what ways do you think this is *your* responsibility?
2. How well do you think you can handle this responsibility?

Appendices

Appendix A
Regulatory Agencies in Agreement States

Appendix B
NRC Regional Offices

Appendix C
How to Obtain NRC Regulations and Guides

Appendix D
NRC Forms

Appendix E
Glossary

Appendix F
Overexposure Accidents (1971-1980)

Appendix G
References and Notes

Appendix H
Photo Credits and Acknowledgments



Regulatory Agencies In Agreement States Addresses and Telephone Numbers

December 1981

Alabama 205-832-5992
Division of Radiological Health
Environmental Health
Administration
Room 314, State Office Building
Montgomery, Alabama 36130

Arizona 602-255-4845
Arizona Radiation Regulatory
Agency
925 South 52nd Street
Tempe, Arizona 85281

Arkansas 501-661-2301
Division of Environmental Health
Protection
Arkansas Department of Health
4815 West Markham Street
Little Rock, Arkansas 72201

California 916-445-0931
Radiologic Health Section
Department of Health
714 P Street
Sacramento, California 95814

Colorado 303-320-8333 Ext. 6246
Radiation and Hazardous Waste
Control Division
Department of Public Health
4210 East 11th Avenue
Denver, Colorado 80220

Florida 904-487-1004
Radiological Health Program
Department of Health and
Rehabilitative Service
1317 Winewood Blvd.
Tallahassee, Florida 32301

Georgia 404-894-5795
Radiological Health Section
Department of Human Resources
47 Trinity Avenue
Atlanta, Georgia 30334

Idaho 208-334-4108
Radiation Control Section
Idaho Department of Health and
Welfare
Statehouse
Boise, Idaho 83720

Kansas 913-862-9360 Ext. 284
Bureau of Radiation Control
Department of Health and
Environment
Building 740, Forbes Field
Topeka, Kansas 66620

Kentucky 502-564-3700
Radiation Control Branch
Department for Human Resources
275 East Main Street
Frankfort, Kentucky 40621

Louisiana 504-925-4518
Nuclear Energy Division
Office of Environmental Affairs
P.O. Box 14690
Baton Rouge, Louisiana 70898

Maryland 301-383-2744
Division of Radiation Control
Department of Health and Mental
Hygiene
201 W. Preston Street
Baltimore, Maryland 21201

Mississippi 601-354-6670
Division of Radiological Health
State Board of Health
P.O. Box 1700
Jackson, Mississippi 39205

Nebraska 402-471-2168
Division of Radiological Health
Department of Health
301 Centennial Mall, South
P.O. Box 95007
Lincoln, Nebraska 68509

Nevada 702-885-4750
Radiological Health Section
Consumer Health Protection
Services
Kinkead Bldg., Capitol Complex
Carson City, Nevada 89710

New Hampshire 603-271-4587
Bureau of Environmental Health
Division of Health Services
Health and Welfare Bldg.
Hazen Drive
Concord, New Hampshire 03301

New Mexico 505-827-5271
Radiation Protection Bureau
Environmental Improvement
Division
P.O. Box 968
Santa Fe, New Mexico 87504

New York 518-474-2178
Bureau of Nuclear Operation
State Energy Office
2 Rockefeller Plaza
Albany, New York 12223

North Carolina 919-733-4283
Radiation Protection Section
Division of Facility Service
Box 12200
Raleigh, North Carolina 27605

North Dakota 701-224-2374
Division of Environmental
Engineering
North Dakota Department of Health
1200 Missouri Avenue
Bismarck, North Dakota 58501

Oregon 503-229-5797
Radiation Control Section
Division of Health
1400 South West Fifth Avenue
Portland, Oregon 97201

Rhode Island 401-277-2438
Division of Occupational Health and
Radiation Control
Department of Health
Cannon Building, 75 Davis Street
Providence, Rhode Island 02908

South Carolina 803-758-5548
Bureau of Radiological Health
Department of Health and
Environmental Control
2600 Bull Street
Columbia, South Carolina 29201

Tennessee 615-741-7812
Division of Radiological Health
Department of Public Health
344 Cordell Hull Building
Nashville, Tennessee 37219

Texas 512-458-7341
Bureau of Radiation Control
Texas Department of Health
1100 W. 49th Street
Austin, Texas 78756

Washington 206-753-3468
Radioactive Materials, LD-11
Department of Social and Health
Services
Olympia, Washington 98504

Updated lists of state addresses
and telephone numbers are avail-
able upon request from:

**Assistant Director for State
Agreements Program
Office of State Programs
U.S. Nuclear Regulatory
Commission
Washington, D.C. 20555
(301) 492-7767**

NRC Regional Offices

B

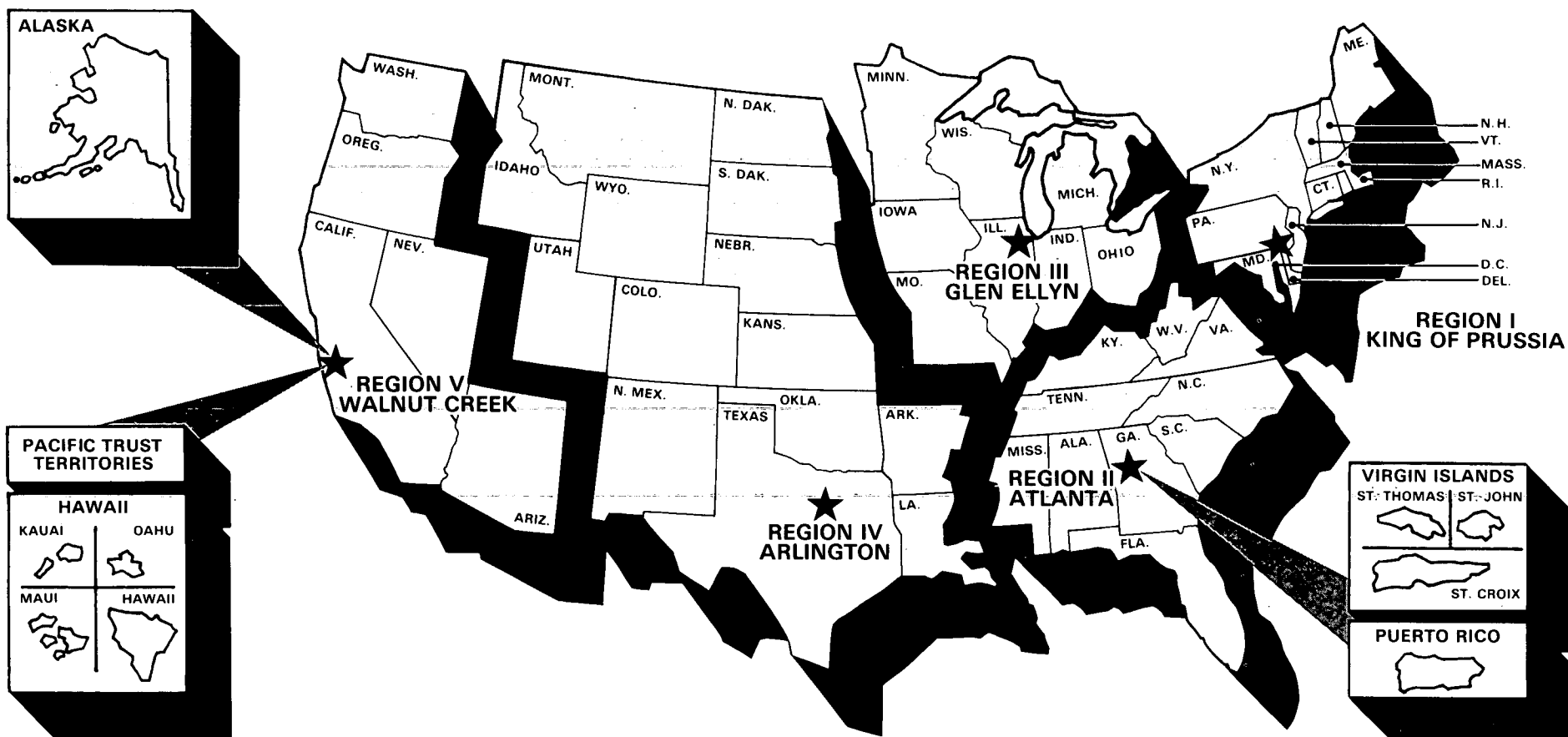

**United States
Nuclear Regulatory
Commission**

Region	Administrator	Address	Telephone
I	Ronald C. Haynes	631 Park Avenue, King of Prussia, Pennsylvania 19406	215-337-5000
II	James P. O'Reilly	101 Marietta St., NW, Atlanta, Georgia 30303	404-221-4503
III	James G. Keppler	799 Roosevelt Road, Glen Ellyn, Illinois 60137	312-932-2500
IV	John T. Collins	611 Ryan Plaza Drive, Arlington, Texas 76011	817-860-8100
V	Robert H. Engelken	1450 Maria Lane, Walnut Creek, California 94596	415-937-3700





How To Obtain NRC Regulations And Guides

Regulations

To purchase a complete copy of NRC regulations, which are contained in Title 10 of the Federal Regulations (10 CFR), Chapter 1 (printed annually), write to:

Document Order and Distribution Office
Superintendent of Documents
Government Printing Office
Washington, D.C. 20402
Telephone: (202) 783-3238

Specify that you want 10 CFR Parts 0-199. The cost of this publication was \$7.50 for the 1981 edition.

For a basic looseleaf copy of 10 CFR, Chapter 1, and continuing supplemental service, write to the address above, and specify that you want the:

U.S. Nuclear Regulatory Commission Rules and Regulations
Title 10, Chapter 1, Code of Federal Regulations - Energy

The cost of this subscription was \$60 per year in 1981. Payment may be made by check, GPO charge account number, or a major credit card.

For single copies of specific parts of 10 CFR, write to:

Division of Technical Information & Document Control
Distribution Services Branch
U.S. Nuclear Regulatory Commission
Washington, D.C. 20555
Telephone: (301) 492-7333

Single copies are furnished free of charge.

Regulatory Guides

The only regulatory guide dealing exclusively with industrial radiography is Regulatory Guide 10.6, "Guide for the Preparation of Applications for Use of Sealed Sources and Devices for Performing Industrial Radiography."

Draft guides are free upon written request. Requests for single copies of draft guides should be sent to:

U.S. Nuclear Regulatory Commission
Washington, D.C. 20555
Attention: Publication Unit.

Requests for placement on an automatic distribution list to receive draft guides should be sent to the same address, Attention: Sales Manager, 016.

To inquire about pricing and availability of **active guides** as single copies or on a subscription basis, write to:

U.S. Nuclear Regulatory Commission
Washington, D.C. 20555
Attention: Sales Manager, 016.
Telephone: (301) 492-9530





Form NRC-4

NRC Form 4 (12-81) 10 CFR 20 Approved by OMB 3150-0005 Expires 4-30-83
 U.S. NUCLEAR REGULATORY COMMISSION
OCCUPATIONAL EXTERNAL RADIATION EXPOSURE HISTORY
 See Instructions on the Back

IDENTIFICATION

1. NAME (PRINT - LAST, FIRST, AND MIDDLE) **McGuire, Stephen A.**
 2. SOCIAL SECURITY NO. **113-34-6489**
 3. DATE OF BIRTH (MONTH, DAY, YEAR) **Nov. 18, 1942**
 4. AGE IN FULL YEARS (IN) **38**

OCCUPATIONAL EXPOSURE - PREVIOUS HISTORY

5. PREVIOUS EMPLOYMENTS INVOLVING RADIATION EXPOSURE - LIST NAME AND ADDRESS OF EMPLOYER	6. DATES OF EMPLOYMENT (FROM-TO)	7. PERIODS OF EXPOSURE (FROM-TO)	8. WHOLE BODY DOSE (REM)	9. RECORD OR CALCULATED (INSERT ONE)
U.S. Inspection Company, Washington, D.C.	10/72 to present	10/72 to present (6-30-81)	0.2	record
Comissão Nacional de Energia Nuclear, Rio de Janeiro, Brazil	5/71 to 10/72	5/71 to 10/72	7.5	calculated *
Bechtel Corp, San Francisco, Cal.	5/70 to 5/71	5/70 to 5/71	0	record
University of Wisconsin, Madison, Wisc.	6/64 to 5/70	6/64 to 5/70	1.3	record

10. REMARKS
 * Dose records could not be obtained. Calculated dose is 1 1/2 rems/quarter x 6 quarters = 7.5 rems [following the method in 10 CFR §20.102(c)]

11. ACCUMULATED OCCUPATIONAL DOSE - TOTAL **9.0**

13. CALCULATIONS - PERMISSIBLE DOSE WHOLE BODY
 (A) PERMISSIBLE ACCUMULATED DOSE - 5(10-18) **100.0 REM**
 (B) TOTAL EXPOSURE TO DATE (IF FROM ITEM 11) **9.0 REM**
 (C) UNUSED PART OF PERMISSIBLE ACCUMULATED DOSE (A-B) **91.0 REM**

12. CERTIFICATION: I CERTIFY THAT THE EXPOSURE HISTORY LISTED IN COLUMNS 5, 6, AND 7 IS CORRECT AND COMPLETE TO THE BEST OF MY KNOWLEDGE AND BELIEF.
 EMPLOYEE'S SIGNATURE **Stephen G. McGuire** DATE **7/14/81**
 EMPLOYER'S SIGNATURE **U.S. Inspection Company**
 NAME OF LICENSEE **Washington, D.C.**

Form NRC-5

NRC Form 5 (10-81) 10 CFR 20 Approved by OMB 3150-0005 Expires 4-30-83
 U.S. NUCLEAR REGULATORY COMMISSION
CURRENT OCCUPATIONAL EXTERNAL RADIATION EXPOSURE
 See Instructions on Back

IDENTIFICATION

1. NAME (PRINT - Last, first, and middle) **McGuire, Stephen A.**
 2. SOCIAL SECURITY NO. **113-34-6489**
 3. DATE OF BIRTH (Month, day, year) **Nov. 18, 1942**
 4. NAME OF LICENSEE **U.S. Inspection Company**

5. DOSE RECORDED FOR (Specify: Whole body, skin of whole body, or hands and forearms, feet and ankles) **whole body**
 6. WHOLE-BODY DOSE STATUS (rem) **91.0 rem**
 7. METHOD OF MONITORING (e.g., Film Badge, FB; Pocket Chamber - PC; Calculations - Calc.)
 X OR GAMMA **FB** BETA **FB** NEUTRONS **none**

8. PERIOD OF EXPOSURE (From - To)

8. PERIOD OF EXPOSURE (From - To)	DOSE FOR THE PERIOD (rem)			12. RUNNING TOTAL FOR CALENDAR QUARTER (rem)	13. RUNNING TOTAL FOR CALENDAR YEAR (rem)
	9. X OR GAMMA	10. BETA	11. NEUTRON		
1/1/81 - 1/31/81	0.010	-	-	0.010	0.010
2/1/81 - 2/28/81	0.020	-	-	0.020	0.030
3/1/81 - 3/31/81	0	-	-	0	0.030
4/1/81 - 4/30/81	0.040	-	-	0.040	0.040
5/1/81 - 5/31/81	0.020	-	-	0.020	0.060
6/1/81 - 6/30/81	0.020	-	-	0.020	0.080
7/1/81 - 7/31/81	0.050	-	-	0.050	0.050

LIFE TIME ACCUMULATED DOSE

14. PREVIOUS TOTAL (rem)	15. TOTAL QUARTERLY DOSE (rem)	16. TOTAL ACCUMULATED DOSE (rem)	17. PERM. ACC. DOSE 5(10-18) (rem)	18. UNUSED PART OF PERMISSIBLE ACCUMULATED DOSE (rem)
9.0	0.03	9.03	100 rem	90.97
	0.08	9.11		90.89

Form NRC-241

FORM NRC-241
(12-79)
10 CFR 150

U.S. NUCLEAR REGULATORY COMMISSION

FORM APPROVED BY GAO
R-0078
EXPIRES 10-31-80

REPORT OF PROPOSED ACTIVITIES IN NON-AGREEMENT STATES
(Please read the instructions on the cover sheet before completing this form.)

1. NAME OF LICENSEE (Person or firm proposing to conduct the activity described below) **Big Apple Radiographs**

2. ADDRESS OF LICENSEE (Mail stop, address, or other location where activity may be located) **376 Hudson Street
New York, N. Y. 10014**

3. NAME OF PERSON AUTHORIZED BY LICENSEE TO PERFORM ACTIVITY **S. McGuire + C. Peabody**

4. DESCRIPTION OF ACTIVITIES TO BE CONDUCTED IN NON-AGREEMENT STATES UNDER THE GENERAL LICENSE GIVEN IN 10 CFR 150.20
industrial radiography

5. LOCATIONS AT WHICH THESE ACTIVITIES WILL BE CONDUCTED AND DATES SCHEDULED

STREET AND NUMBER OR OTHER LOCATION (Give to complete in address as possible)	CITY AND STATE	DATE(S) SCHEDULED FROM TO	NO. OF DAYS
Moore-McCormack Lines, Pier 17	Hoboken, N. J.	7/13/81 7/24/81	12

6. LIST SEALED SOURCES, OR DEVICES CONTAINING SEALED SOURCES, WHICH WILL BE POSSESSED, USED, INSTALLED, SERVICED, OR TESTED IN NON-AGREEMENT STATES. (Include description of type and activity of sealed source material determined in each sealed source or device.)

7. NUMBER OF SPECIFIC LICENSE AND NAME OF STATE ISSUING SUCH SPECIFIC LICENSE WHICH AUTHORIZES THE UNDERSIGNED TO CONDUCT ACTIVITIES WHICH ARE THE SAME, EXCEPT FOR LOCATION OF USE, AS THOSE SPECIFIED IN ITEM 4 ABOVE. (If any copies of the specific license exist a company and report.)

CERTIFICATE

8. I, THE UNDERSIGNED, HEREBY CERTIFY THAT

(a) All information in this report is true and complete.

(b) I have read and understand the provisions of the general license 10 CFR 150.20 reported on in this report and I will understand that I am required to comply with these provisions as to all types of source or special nuclear material which I possess and use in non-agreement states under the general license for which this report is filed with the U.S. Nuclear Regulatory Commission.

(c) I understand that activities included in this report are in non-agreement states, as defined in 10 CFR 150.20, see limitations on paragraph 180 here in any calendar year.

DATE: **July 9, 1981**

LICENSEE'S NAME (I or COMPANY): **Big Apple Radiographs**

CERTIFYING OFFICIAL:

NATURE: **Nunzio Palomaro**

TITLE: **NDT Supervisor**

WARNING: (18 U.S.C. Section 1001; Act of June 25, 1948, 60 Stat. 749) and 18 U.S.C. Section 1001 make it a criminal offense to make a knowingly false statement or report (penalty is a fine (not to exceed \$10,000) or imprisonment (not to exceed 5 years) or both).

Gamma Radiography Terms and Common Abbreviations

This glossary contains terms as they are used in gamma radiography. Terms shown in bold face type in the text are defined in this glossary. However, some terms in this glossary have not been used in the text. They are included for your information because you may hear them during your work.

- absorbed dose** A highly technical term meaning the radiation dose or amount of radiation that has been absorbed by some substance. Absorbed dose is measured in units of **rads**.
- activity** A measure of the strength of a radioactive source. Activity is measured in units of **curies**.
- acute radiation exposure** Exposure to a large dose of radiation in a short period of time. In radiography, this usually refers to the dose a person receives from coming very near a source.
- acute radiation syndrome** The medical term for **radiation sickness**.
- Agreement State** A state that has signed an agreement with the Nuclear Regulatory Commission allowing the state to regulate certain activities using radioactive materials, for example, gamma radiography using iridium-192 or cobalt-60 sources.

alpha particle (alpha ray, alpha radiation)

A small electrically charged particle of ionizing radiation thrown off by some radioactive materials. Alpha particles have a short range and cannot penetrate the outer dead layer of human skin. But, if radioactive materials emitting alpha particles are inhaled or swallowed, they can be very dangerous.

ASNT American Society for Nondestructive Testing: a professional organization concerned with nondestructive testing, including industrial radiography.

atom A unit of matter. An atom consists of a central charged nucleus (made up of neutrons and protons) and electrons that surround the nucleus.

attenuation The reduction in the intensity of radiation as it passes through any material, for example, through lead shielding.

audible-alarm dosimeters Small electronic instruments that a person can wear. These dosimeters will sound an alarm when a high radiation dose rate is encountered or when a certain radiation dose has been exceeded. Sometimes called "alarming pocket dosimeters" or "electronic pocket dosimeters."

autoradiographs Radiographs of an object made by using the radiation that comes from the object itself without using any other radiation source.

- background radiation (natural)** Radiation that is emitted from the naturally occurring radioactive materials in the earth and from cosmic rays that bombard the earth from outer space.
- ballstop** A ball attached to the pigtail of a radiography source that prevents the source from being pulled out the back of the camera.
- battery check** A check to see that the batteries of a radiation survey meter are strong enough. Generally, a "battery-check button" is pushed and a needle moves to show if the batteries are strong enough.
- Becquerel, Henri** The French scientist who first discovered a naturally occurring radioactive material, uranium, in 1896.
- BEIR Committee** Biological Effects of Ionizing Radiation Committee of the National Academy of Sciences. This committee is composed of a group of eminent scientists from throughout the U.S. who report to the Academy on the health effects of radiation.
- beta particle (beta ray, beta radiation)** An electrically charged particle of radiation emitted by many radioactive materials. A beta particle is a fast-moving electron, sometimes moving close to the speed of light.
- bill of lading** A document accompanying a shipment of goods that lists the contents of the shipment.
- byproduct material** Radioactive material, such as cobalt-60 or iridium-192, obtained as a byproduct of running nuclear reactors or making nuclear fuel.
- calibration** Adjustment of a radiation survey meter to make it read a radiation dose accurately. A radiation source must be used for proper calibration.
- camera, beam-type** A radiography camera where the radioactive source never leaves the camera. The source is exposed by moving it in front of an opening or by moving a piece of shielding away from the front of the source.
- camera, crank-out** A radiography camera where the source is cranked or pushed out of the shield to make the radiography exposure.
- camera, fixed** A radiography camera that is not movable.
- camera, mobile** A radiography camera that can be moved by pushing it on wheels.
- camera, pipeline** A beam-type radiography camera especially made for radiographs of pipelines. Often called a "pipeliner."
- camera, portable** A radiography camera that can be carried by hand.
- camera, radiography (or gamma radiography camera)** A container with a shield inside to hold a gamma radiography source. A means is provided to move the source outside the shield or remove part of the shield to make radiographs. It is called a camera because it is used to take pictures (radiographs). Also called a **radiography exposure device** or **radiographic exposure device**.

- cancer** A disease in which rapidly multiplying cells grow in the body, interfering with its natural functions. **Ionizing radiation** may increase the probability that a person will get cancer.
- capsule, radiography source** The small sealed metal capsule containing the radioactive materials that emit the gamma rays used in gamma radiography.
- cassette** The covering that radiography film is placed in to prevent light from striking the film.
- cataract** A medical term for the loss of transparency of the lens of the eye.
- cell, radiography** A shielded room in which radiography exposures are made. Called a "permanent radiographic installation" in NRC regulations. Also called an exposure cell.
- cesium-137** A radioactive material sometimes used in radiography. An isotope of the element cesium. It emits gamma rays with an energy of 0.662 MeV and has a half-life of 30 years. Symbols: Cs-137, ¹³⁷Cs, Cs¹³⁷.
- CFR** See **Code of Federal Regulations**.
- chirper** An electronic dosimeter that "chirps" or "beeps" periodically in the presence of radiation. It is a type of audible-alarm dosimeter. It chirps faster when the dose rate increases.
- chromosome** All the genetic material or genes contained in a living cell. Chromosomes control the reproduction of cells and the characteristics of the cells produced from the original cell. See **gene**.
- cobalt-60** A radioactive material used in radiography, noted for very penetrating gamma rays. An isotope of the element cobalt. It emits gamma rays of energy 1.17 MeV and 1.33 MeV. It has a half-life of 5.3 years. Symbols: Co-60, ⁶⁰Co, Co⁶⁰.
- Code of Federal Regulations (CFR)** The volume of books containing the regulations issued by federal agencies.
- collimator** A small radiation shield of lead or other heavy metal used in radiography. A collimator is placed on the end of the guide tube and has a small opening through which a narrow cone of radiation escapes when the source is cranked into position. Use of a collimator can greatly reduce the size of the area to which access must be restricted.
- contamination, radioactive** The presence of radioactive material spread on surfaces where it is not supposed to be.
- control cable** Means the same as **drive cable**.
- cosmic radiation** Ionizing radiation that comes from outer space. See **background radiation, natural**.
- coupon, test** A test sample of a welder's work. The coupon will be radiographed to determine whether the welder is qualified for the welding job.

- crank or crank handle** The handle used to crank the source in or out in a crank-out camera.
- crank-out camera or device** See **camera, crank-out**.
- curie** A basic unit to describe the intensity (strength) of radioactivity in a material. A curie is a measure of the rate at which a radioactive material throws off particles or disintegrates. One curie is equal to 37 billion **disintegrations** per second.
- Curie, Marie and Pierre** The French scientists who discovered **radium** in 1898 and made possible the start of gamma radiography.
- decay constant** A numerical constant that expresses the rate at which radioactive materials decay.
- decay curve** A graph showing the decreasing radioactivity of a radioactive source as time passes. The term can also refer to the line or curve on the graph that indicates the activity.
- decay, exponential** A mathematical expression to describe the rate at which a radioactive material decays.
- decay, logarithmic** The same as exponential decay.
- decay, radioactive** The breaking up or **disintegration** of atoms that have excess energy. Radiation is emitted in the process.
- delayed effects** Those effects caused by radiation that do not become evident until years after exposure to radiation. The possible delayed effects of radiation are cancer in the exposed persons and genetic defects in their offspring.
- densitometer** An instrument used to read how dark a piece of film is.
- depleted uranium** Uranium having a smaller percentage of uranium-235 than that found in uranium as it occurs naturally. Depleted uranium is an excellent shielding material.
- detector, gas-filled** A radiation detector filled with gas. It detects ions formed by radiation.
- detector, radiation** The part of a radiation survey meter that is sensitive to radiation.
- disintegration** The breaking up of an unstable atom. Radiation is emitted in the process. See **decay, radioactive**, and **curie**.
- DNA** Deoxyribonucleic acid. The long spiral molecules found in all living cells that control cell functioning and reproduction. Radiation injury is the result of damage of these molecules.
- dose** Dose is the amount of radiation absorbed by an object. Dose can be expressed in units of **roentgens**, **rems**, or **rads**.
- dose equivalent** A highly technical term referring to radiation dose expressed in units of rems.

Glossary

E

- dose rate** A measure of how fast a radiation dose is being received. It is a dose per unit of time. For example, "The dose rate is 10 millirems per hour."
- dosimeter** A device used to determine the radiation dose a person has received. *See* **dosimeter, pocket**; **film badge**; and **dosimeter, thermoluminescent**.
- dosimeter, pocket** A small air-filled ionization chamber (about the size and shape of a cigar) that measures radiation dose by responding to ionization in the air.
- dosimeter, thermoluminescent** A dosimeter worn by a person to measure radiation dose. It contains a radiation-sensitive crystal that responds to radiation like the film in a film badge.
- DOT** U.S. Department of Transportation. A federal agency that regulates the transport of radioactive materials.
- drive cable** A cable used to push a source out of a crank-out camera. Usually operates with a crank. Also called a **control cable**.
- electromagnetic radiation (or waves)** *See* **radiation, electromagnetic**.
- electron** A very light particle that rotates around the nucleus of an atom and carries a negative electric charge. Electricity is the flow of electrons.
- electron volt** A small unit of energy. The energy of x-rays and gamma rays is often given in units of electron volts. Abbreviations: eV - electron volts; KeV - thousand electron volts; MeV - million electron volts.
- element** A basic type of matter. Each element has distinct chemical properties. There are 92 different elements that are found in nature, for example, hydrogen, oxygen, lead, uranium, carbon, tungsten, and iron.
- "empty" label** A DOT label used when a container normally used for transporting radioactive material does not contain any radioactive material.
- erythema** A medical term for a reddening of the skin caused by increased local circulation of blood as a reaction to tissue injury. It can be caused by very large doses of radiation.
- exclusive-use vehicle** A vehicle that carries no cargo other than a shipment of radioactive material.
- exponential decay** *See* **decay, exponential**.
- exposure** Being exposed to radiation. People can be exposed to a radiation dose, or a film can receive an exposure to radiation. In radiography, "an exposure" or "shot" is the making of a radiograph. Exposure is also a highly technical term meaning the amount of ionization in air caused by x-rays or gamma rays, which is measured in units of roentgens.
- exposure device, radiographic** The term used in NRC regulations to mean a **radiography camera**.
- fallout, radioactive** Radioactive debris from the explosion of nuclear weapons that falls out of the atmosphere onto the earth.

- film badge** A dosimeter badge worn by radiation workers to measure their radiation dose. The badge contains a piece of film that is darkened by radiation. The radiation dose can be determined by reading how dark the film is.
- gamma alarm** A radiation detector that sounds an alarm when it detects excessive gamma ray or x-ray radiation.
- gamma radiography** *See radiography, gamma.*
- gamma rays**
(γ -rays or gamma radiation) A type of penetrating and ionizing radiation used in industrial radiography. Gammas rays are similar to x-rays but come from the nucleus of an atom when it decays.
- gas-filled detector** *See detector, gas-filled.*
- Geiger counter (Geiger-Muller counter, G-M counter, G-M tube)** An instrument used to detect radiation and to measure radiation dose.
- gene** A part of a living cell that controls the reproduction of the cell and determines the characteristics that the reproduced cells will have. *See chromosome.*
- general license** A license issued by NRC or an Agreement State for possession and use of certain radioactive materials, often for small quantities, for which no specific application is required. Individuals are automatically licensed when they buy or obtain the radioactive materials or use them in some manner. For example, luminous aircraft exit signs containing radioactive materials are licensed without any application. Airlines receive a license simply because they possess such radioactive material. Radiography companies receive a general license when they conduct radiography outside of the jurisdiction (usually a state) where they hold a specific license.
- genetic defect** A defect in a living organism caused by a deficiency in the genes of the original reproductive cells from which the organism was conceived. Genetic defects are passed on to the descendants of the person with the defect.
- guide tube** A hollow tube through which the radiography source travels when it is cranked out of its shielded position in the camera.
- half-life** The time it takes for half the atoms in a radioactive sample to decay. Half-lives vary from a fraction of a second to billions of years. The half-life of cobalt-60 is 5.3 years. The half-life of iridium-192 is 74.2 days.
- half-value thickness (or half-value layer)** The thickness of a material that will reduce the amount of radiation passing through the material to one-half of its initial intensity. The thickness of the half-value thickness will depend on the material and the energy of the gamma rays.
- hangup** The jamming or sticking of a radiography source outside a crank-out camera.
- health physicist** A trained specialist working in radiation protection.

- high radiation area** An area where the radiation dose to a person could exceed 100 millirems in 1 hour. There are special requirements for controlling access to high radiation areas.
- ICRP** International Commission on Radiological Protection. An international group of scientists representing their countries who develop recommendations on radiation dose limits and other radiation protection measures.
- industrial radiography** See **radiography, industrial**.
- infrared radiation** Radiant heat. Heat that is transmitted from one object to another by rays instead of by conduction between objects that touch each other. Infrared radiation is not ionizing radiation so the health effects discussed in Chapter 4 do not apply to this kind of radiation.
- internal contamination** Radioactive contamination within a person's body caused by radioactive material that has been inhaled or swallowed.
- inverse square law** A law of nature that states how the intensity of radiation decreases as a person moves away from a radiation source of small dimension. The law states that the intensity will decrease proportionately to the distance squared. This means that moving twice as far from a source decreases the intensity of the source by a factor of two squared (2×2), or four.
- ion** An atom that has gained or lost one or more electrons or an electron that is not attached to an atom. Ions have an electrical charge.
- ion pair** A positively charged ion and an electron. The production of ion pairs is the method by which ionizing radiation gives up its energy.
- ionization** The process of adding electrons to, or removing electrons from, atoms or molecules. This creates ions.
- ionization chamber (or ion chamber)** An instrument similar to a Geiger counter that is used to detect and measure radiation.
- ionizing radiation** See **radiation, ionizing**.
- iridium-192** A radioactive isotope of the element iridium that emits gamma rays of energies from 0.3 MeV to 0.61 MeV. It has a half-life of 74.2 days. A radioactive source used in gamma radiography. Symbols: Ir-192, ^{192}Ir , Ir^{192} .
- isotope** A particular form of an element. The isotopes of an element have the same chemical properties but different nuclear properties. One isotope of an element may be radioactive while another isotope of the element is stable.
- keV (kilo electron volts)** A unit of energy equal to 1,000 electron volts.

- large quantity** In transporting radioactive materials, a large quantity is an amount of radioactive materials exceeding a certain number of curies. If the materials are radiography sources (in special form), the amount is larger than 5000 curies. Special packaging is required by DOT regulations for large quantities of radioactive materials.
- laser beam** An intense beam of light that spreads out much more gradually than ordinary light beams.
- lead screen** A thin sheet of lead placed next to the radiographic film. Gamma rays interact strongly with the lead, knocking electrons out. The electrons strike the film and cause a more intense image than if there had been no lead screen.
- leak test** A check for the escape of radioactive material from a radiography source.
- leukemia** An often fatal cancer characterized by excessive production of white blood cells.
- licensee** The company or the person authorized to use radioactive materials under a license issued by the Nuclear Regulatory Commission or an Agreement State.
- lock box** The part of a radiography camera that contains the locking mechanism used to lock the radiography source into its safe shielded position.
- logarithmic decay** See **decay, logarithmic**.
- logarithmic scale (or log scale)** A scale used on some graph paper where the spacings on the scale get closer and closer together as the quantity shown by the scale increases.
- LSA (low specific activity) material** Radioactive material that emits very little radiation for its weight. Exactly defined in 10 CFR Section 71.4(g)(15).
- manmade radiation** Radiation produced by manmade (not natural) sources, such as x-ray machines and nuclear power plants.
- median lethal dose** The radiation dose that would result in the death of 50% of the people exposed to that dose. This dose is approximately 450 rems (450,000 mrem) delivered to the whole body within a few hours or a few days.
- MeV (million electron volts)** A unit of energy equal to 1,000,000 (1 million) electron volts. Used to express the energy of gamma rays and x-rays.
- microwaves** A form of radiation that is non-ionizing. Microwaves are more energetic than radio waves, but less energetic than visible light. If microwaves are very intense, they can damage living cells by heating them excessively.
- millirem (mrem)** A commonly used unit of radiation dose, abbreviated mrem. A millirem is equal to one-thousandth of a rem.

- molecule** The smallest unit of a chemical compound. A water molecule consists of two hydrogen atoms combined with one oxygen atom; hence, the well-known formula, H₂O.
- mutation** In a cell, a change in the genes or genetic material of the cell. In humans, people who have genetic defects in all their cells. *See* **genetic defect**.
- natural background radiation** *See* **background radiation, natural**.
- natural radioactivity** The radioactivity from naturally occurring elements that are radioactive, for example, radium, carbon-14, uranium, thorium, and potassium-40.
- NCRP** National Council on Radiation Protection and Measurements. A group of eminent scientists in the U.S. that develops recommendations on radiation protection.
- negative electrical charge** An electrical charge that is attracted to positive electrical charges. Electricity is the movement of negative electrical charges (**electrons**).
- neutron** One of the basic particles within atoms (the others are electrons and protons).
- neutron radiography** *See* **radiography, neutron**.
- non-Agreement State** A state in which the NRC regulates the use of radioactive materials, for example, gamma radiography. *See also* **Agreement State**.
- nondestructive testing (NDT)** The testing or examination of an object without destroying the object to ensure that it is free from flaws. Industrial radiography, ultrasonic testing, magnetic particle testing, and dye penetrant testing are examples of nondestructive testing.
- non-exclusive-use vehicle** A vehicle used by a commercial carrier to transport packages to and from many destinations. Packages may be either radioactive or not. *See* **exclusive-use vehicle**.
- non-ionizing radiation** *See* **radiation, non-ionizing**.
- normal form** Radioactive materials that do not have special escape-proof containers. For example, liquids and powders in jars are normal form. But iridium-192 welded inside a steel capsule is not normal form (it is **special form**).
- NRC** U.S. Nuclear Regulatory Commission. A federal agency that regulates the use of certain radioactive materials, for example, the use of iridium-192 and cobalt-60 in industrial radiography.
- nucleus** The inner core of an atom or a living cell. In an atom, the nucleus consists of neutrons and protons tightly locked together. In a living cell, the nucleus contains the genes or genetic material of the cell. The plural of nucleus is nuclei.
- operating procedures** A set of instructions supplied by the company on how to perform radiography exposures in that company.

- OSHA** U.S. Occupational Safety and Health Administration. A federal agency that regulates safety in the work place, excluding radiation safety when regulated by NRC or an NRC Agreement State.
- overexposure, radiation** Receiving a radiation dose in excess of legal regulatory limits. Most radiation overexposures do not have any visible medical symptoms.
- overpack** An outer container for a radiography camera used to meet certain requirements for transportation, for example, to lower the radiation dose rate at the surface of the package or to add protection to an inner package.
- panoramic shot or exposure** A radiographic shot or exposure in which film is exposed on a 360-degree circle around the source. For example, if the source is in the center of a pipe, a panoramic shot will radiograph the entire circumference of the pipe.
- penetrating radiation** *See radiation, penetrating.*
- penetrameter** A piece of metal of specific thickness with holes or slots in it. It is placed in front of the radiographic film near the area being inspected to show what size defects can be detected.
- pig** A casting of metal from a mold. In radiography, pig generally refers to lead or uranium that has been cast as a shield.
- pigtail** The part of a radiography source assembly that includes the short cable and connector, but not the source capsule. The term sometimes includes the source capsule as well.
- pill** The sealed source capsule at the end of a radiography assembly containing the radioactive material.
- placard** In transporting radioactive materials, a sign on a vehicle that indicates the vehicle is carrying packages containing radioactive materials that require **Radioactive Yellow III** warning labels on the packages.
- pocket chamber** Another name for a **pocket dosimeter**.
- pocket dosimeter** *See dosimeter, pocket.*
- positive electrical charge** An electrical charge that is attracted to electrons or other negative electrical charges.
- probe, radiation** A radiation detector mounted outside the case of a **survey meter**.
- projector, gamma ray** A **radiography camera**.
- prompt effects** The harmful health effects of radiation appearing within a day or a few weeks after exposure to a large radiation dose. The prompt effects are **radiation burns** and **radiation sickness**.
- proton** One of the basic particles of an atom (the others are neutrons and electrons). Its electrical charge is the same size as that of the electron, but positive rather than negative.

- quality factor** The factor by which the energy deposited by radiation (**absorbed dose**) is to be multiplied to obtain a quantity that expresses, on a common scale for all types of ionizing radiation, the biological damage to an exposed person. It is used because some types of radiation such as alpha particles are more biologically damaging than other types such as gamma rays and x-rays.
- quartz fiber dosimeter** A **pocket dosimeter**. The moving part of a pocket dosimeter is a quartz fiber.
- rad** A unit of radiation dose. The rad is used to tell how much energy per unit mass is deposited by radiation (absorbed dose). For gamma rays and x-rays, one rad is equal to one **roentgen** or one **rem**.
- radiation** A very broad term that refers to vibrating waves or clouds of pure energy or very fast-moving atomic particles (such as electrons, beta particles, alpha particles). Radiation made of pure energy includes gamma rays, x-rays, visible light, microwaves, infrared waves, ultraviolet rays, and radio waves. *See also radiation, ionizing, and radiation, non-ionizing.*
- radiation area** An area where a person could receive a radiation dose in excess of 5 mrem in any 1 hour or 100 mrem in any 5 consecutive days.
- radiation burns** Burns in flesh caused by ionizing radiation. The burns are not caused by heat but by chemical breakdowns in the nuclei of living cells. However, radiation burns are medically similar to heat burns in effect and in treatment.
- radiation dose** *See dose*
- radiation dose limits** A limit on the radiation dose that a person may receive, as established by a government regulatory agency.
- radiation, electromagnetic** A technical term for radiation that travels as waves, composed purely of electrical and magnetic energy. For example, gamma rays, x-rays, microwaves, visible light, radio waves, infrared waves, and ultraviolet waves or rays.
- radiation, ionizing** Any radiation that has enough energy to break apart chemical bonds and cause atoms to form ions (charged particles). For example, gamma rays, x-rays, beta particles.
- radiation, non-ionizing** Radiation that does not have enough energy to create ions (charged particles). For example, visible light, radio waves, microwaves.
- radiation, penetrating** Radiation that can penetrate matter deeply, such as gamma rays or neutrons. Visible light is radiation, but it is not penetrating. Microwave radiation can penetrate many materials but is not usually included as a type of penetrating radiation.

radiation safety officer (RSO)	A person who has been selected to be responsible for overseeing radiation safety in an organization. Also called by other names such as radiation protection officer, radiation safety manager.	Radioactive Yellow II Label	A warning label for packages containing radioactive material when the dose rate at the surface of the package is less than 50 mrem per hour and the dose rate at 3 feet from any surface of the package is less than 1 mrem per hour.
radiation sickness	Sickness, possibly fatal, resulting from a large exposure to radiation (hundreds of rems) in a short time (within several days).	Radioactive Yellow III Label	A warning label for packages containing radioactive material when the dose rate at the surface of the package is more than 50 mrem per hour or the dose rate at 3 feet from any surface of the package is more than 1 mrem per hour.
radiation survey	See survey, radiation .	radioactivity	The emission of radiation from an unstable atom.
radiation, wavelike	Any radiation that travels as waves composed purely of electrical and magnetic energy. For example, x-rays, gamma rays, microwaves, visible light, radio waves. See radiation, electromagnetic .	radiograph	A picture of an object made by the penetrating and ionizing radiation that passes through the object. Details of the inside of the object will be visible.
radioactive	An adjective describing anything that emits radiation when unstable atoms break up.	radiographer	A person who uses ionizing radiation, such as gamma rays or x-rays, to make radiographs for the purpose of detecting flaws in objects without destroying them.
radioactive contamination	See contamination, radioactive .	radiographer's assistant	An individual who helps a radiographer and who has received some training and is being trained to become a radiographer.
radioactive decay	See decay, radioactive .	radiographic exposure device	The term used in NRC regulations to mean a radiography camera. (See camera, radiography .)
radioactive material	A material containing unstable or radioactive atoms that break up or decay and emit radiation in the process.		
radioactive waste	Waste that contains radioactive material. It must be disposed of in a safe manner according to certain regulations.		
Radioactive White I Label	A warning label for packages containing radioactive material where the dose rate at the surface of the package is less than 0.5 mrem per hour.		

Glossary

E

- radiography** The use of penetrating radiation to make pictures of the inside of objects. If the pictures are of industrial goods, it is called **industrial radiography**. If the pictures are of medical patients, it is called **medical radiography, medical radiology, or radiology**.
- radiography camera** See **camera, radiography**.
- radiography cell** See **cell, radiography**.
- radiography, gamma** Industrial radiography using radioactive materials that emit gamma rays.
- radiography, industrial** The use of penetrating radiation, such as x-rays, gamma rays, or neutrons, to make pictures of the insides of objects, for example, to inspect metal castings or welds for internal flaws. Industrial radiography does not include medical uses of radiation such as chest x-rays or dental x-rays.
- radiography, neutron** Industrial radiography using neutrons as the penetrating radiation.
- radiography source** See **source, radiography**.
- radiography, x-ray** Industrial radiography using x-ray machines as the source of radiation.
- radioisotope (or radioactive isotope)** A form (**isotope**) of an element that is radioactive. For example, cobalt-60 is a radioisotope.
- radium (or radium-226)** A naturally occurring radioactive material used in the first gamma radiography sources, but seldom used any more.
- range switch** A switch on a radiation survey meter that changes the scale of the meter, for example, from 0 to 10 mR/hr to 0 to 1000 mR/hr.
- rate, dose** A measure of the speed at which dose accumulates, that is, 1 mrem per hour. Similar to the speed of an automobile in miles per hour, which is a mileage rate.
- reciprocity** The recognition by the NRC or by an Agreement State of a license issued by the other. Reciprocity allows a radiography company licensed in one jurisdiction (usually a state) to work in a different jurisdiction where it is not specifically licensed.
- rem** A unit of radiation dose. A rem is equal to 1000 millirem.
- restricted area** An area to which access is controlled for the purpose of radiation protection. If the dose to a person in an area from radioactive material could exceed 2 mrem in any 1 hour or 100 mrem in any 1 week, access to the area must be restricted.
- roentgen** A unit of radiation dose. Abbreviated "R." A roentgen is equal to 1000 milliroentgens (mR).
- Roentgen, Wilhelm** The German scientist who discovered x-rays in 1895.
- rotor shaft** A shaft or axle in a beam-type camera that is rotated to expose the source.
- RSO** Radiation safety officer. See **radiation safety officer**.

S-tube	A curved tube inside the shield of a crank-out radiography camera. The radioactive source enters and exits the camera through the S-tube . The S-tube is shaped like the letter "S" so that a beam of radiation cannot escape through the tube when the source is in its shield.	shot	Exposing a radiography source to make a radiograph. Also called an exposure .
safety plug	A plug put in the S-tube entrance of a crank-out camera to keep dirt out and prevent the source from moving out if the lock is not working.	source	This term can refer either to any source of radiation or to a radiography source in particular.
scintillation counter	An instrument that detects radiation by counting the small flashes of light (scintillations) the radiation produces when it hits certain crystals.	source assembly	The radiography source, including the source capsule, the pigtail cable, and the connector for connecting it to the drive cable.
sealed source	Radioactive material sealed in a capsule designed to prevent leakage or escape of the material.	source capsule	The steel capsule that the radioactive materials are welded within to make the radiography source.
semilogarithmic graph paper (or semilog paper)	Graph paper with one logarithmic scale and one normal scale.	source changer	A shielded container with two holes for sources. The old source is cranked into the changer and the new source is cranked out.
shield	A structure made of shielding material to reduce radiation levels.	source conduit	A source guide tube .
shield, shadow	A shield that partially shields radiation from a source. The shield creates a shadow where there is little radiation.	source port protector cap	A safety plug or cap that fits over the S-tube through which the source exits (in a crank-out camera).
shielding (or shielding material)	Material that can be placed around a radiation source for the purpose of reducing radiation levels.	source, radiation	Any source of radiation.
shim	A piece of metal placed under a penetrameter to make the metal section under the penetrameter as thick as the section of weld being radiographed.	source, radioactive	Any source of radiation where the radiation is produced by the decay of radioactive materials rather than electrically as in x-ray machines.
		source, radiography	The radiation source containing radioactive material used in gamma radiography. Radiography source may refer to the entire source assembly, to the source capsule, or to the gamma radiation being emitted for making radiographs.

special form	Radioactive material in a form that limits leakage or dispersal of the material. Radiography sources are special form materials because the radioactive material is contained in a steel capsule that is welded closed.	tenth-value thickness (tenth-value layer)	The thickness of a material that will reduce the amount of radiation passing through the material to one-tenth of its original intensity. The thickness of the tenth-value thickness will depend on the material and the energy of the gamma rays.
specific activity	The activity per unit weight of material, for example, curies per gram. Uranium has a very low specific activity because there are very few disintegrations for a given weight. Iridium pellets in a radiography source have a much higher specific activity.	thermoluminescent dosimeter	See dosimeter , thermoluminescent .
specific license	A license issued to a company or person to possess and use radioactive material after specific written application has been made. See general license .	thorium	A naturally occurring radioactive material like uranium .
survey meter, radiation	A portable instrument that measures radiation dose rate (radiation intensity).	thulium-170	A radioactive form of the element thulium that emits gamma rays with an energy of 91 KeV. It has a half-life of about 129 days. A source used in industrial radiography. Symbols: Tm-170, ¹⁷⁰ Tm, Tm ¹⁷⁰ .
survey, radiation	As used in this manual, a radiation survey is a measurement of the levels of radiation taken by using a radiation survey meter. In NRC regulations, a survey may also include an evaluation of the radiation hazard (for example, by calculation) and may not necessarily include measurements using a survey meter.	TLD	Thermoluminescent dosimeter.
syndrome, acute radiation sickness.	The medical term for radiation sickness .	transport index (TI)	Dose rate in mrem per hour at 3 feet away from the surface of a package containing radioactive materials.
		tritium	A radioactive form (isotope) of the element hydrogen.
		Type A or Type B packaging	A special type of packaging that meets specific regulations for transporting radioactive materials. Most radiography sources require Type B packaging. Exact requirements are given in 10 CFR § 71.4(g).
		ultraviolet light or radiation	A form of radiation that is similar to visible light but is a little more energetic. It is much less energetic than x-rays or gamma rays and does not ionize molecules. Therefore, it is non-ionizing radiation .

- unrestricted area** An area in which the radiation dose to a person would be less than 2 mrem in any 1 hour or 100 mrem in 1 week.
- UNSCEAR** United Nations Scientific Committee on Effects of Atomic Radiation. A committee of internationally known scientists that reports to the U.N. on the effects of radiation.
- uranium** A naturally occurring radioactive material used as a shielding material in radiography cameras. It is also used to fuel nuclear power plants. *See also depleted uranium.*
- U.S. Nuclear Regulatory Commission** *See NRC.*
- utilization log** A written record to keep track of the use of a radiography source.
- warning labels** In radiography, the labels attached to a shipment of radioactive material indicating the radioactive contents and dose rates. *See Radioactive White I, Radioactive Yellow II, and Radioactive Yellow III Labels.*
- wavelike radiation** *See radiation, wavelike.*
- White I Label, Radioactive** *See Radioactive White I Label.*
- wipe test** Same as a **leak test** (see definition).
- Yellow II Label, Radioactive** *See Radioactive Yellow II Label.*
- Yellow III Label, Radioactive** *See Radioactive Yellow III Label.*
- x-ray** Radiation similar to light, but more energetic and therefore more penetrating. X-rays can cause damage to living things. They are usually produced by bombarding a metallic target with electrons (that is, by an electric spark).
- ytterbium-169** A radioactive form of the element ytterbium that emits gamma rays of energy 19 and 76 KeV. It has a half-life of 32 days and is occasionally used in industrial radiography. Symbols: Yb-169, ^{169}Yb , Yb^{169} .

Overexposure Accidents 1971-1980

F

TABLE 1

**People Overexposed to External Radiation
Reported by NRC Licensees, 1971-1980**

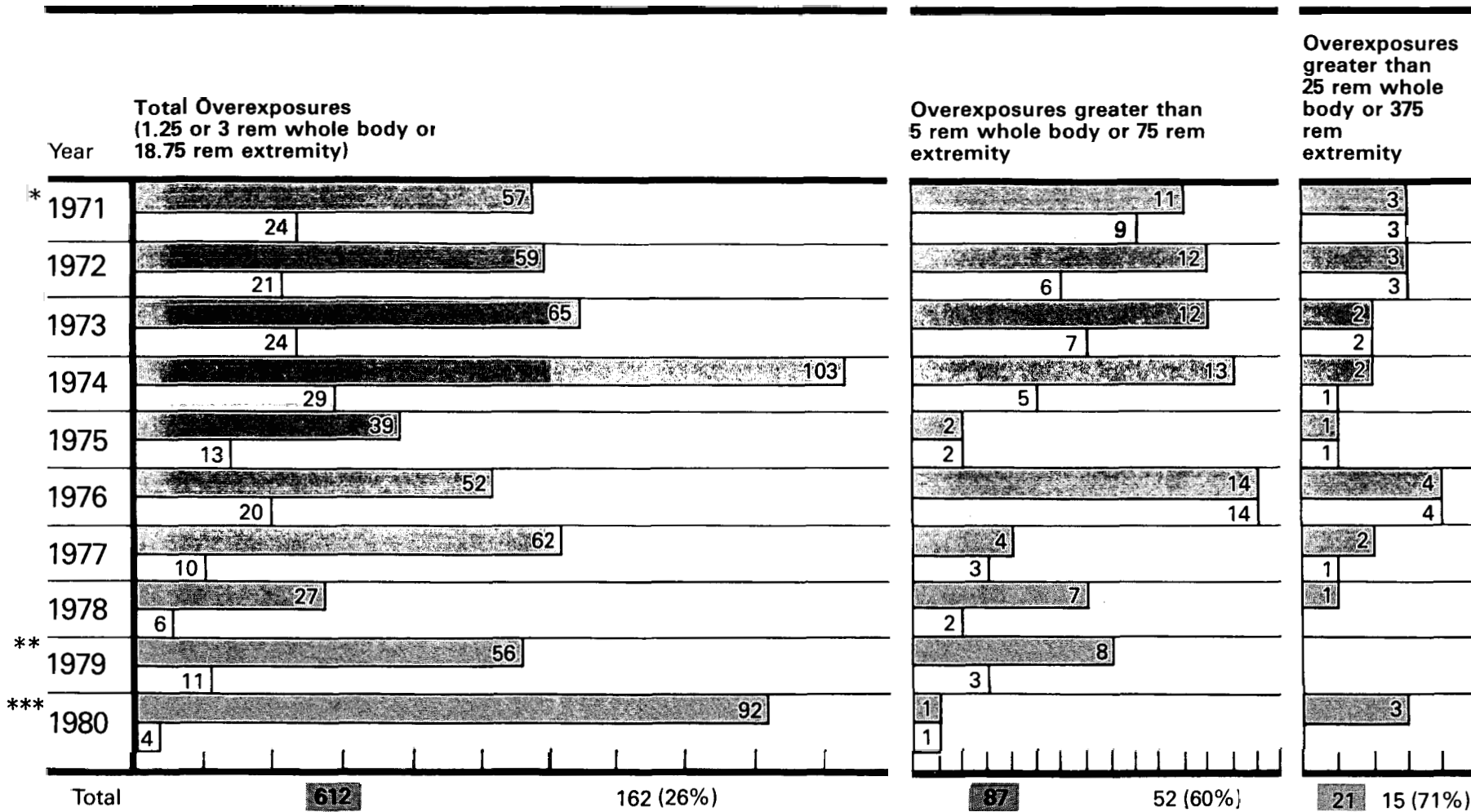

*The values in this table for the years 1971-1978 are from published NRC occupational Radiation Exposure Annual Reports, such as NUREG-0493 for the year 1978.
 **1979 data provided by Barbara Brooks of NRC's Office of Management and Program analysis, May 13, 1981.
 ***1980 data were supplied by Gene Trager of NRC's Office for Analysis and Evaluation of Operational Data, November 1981. They are preliminary data and are subject to change.

All Licensees
 Gamma Radiography

Table 2 Gamma Radiography Overexposure Accidents, 1971-1980

A list of all radiation overexposures reported by NRC licensed radiography companies, exceeding 5 rems to the whole body or 75 rems to a part of the body*

No.	Date	Company	Source	Dose	Symptoms	Why Was Source Exposed?	Was a Survey Made?	Other Factors
1.	1/4/71	Black Sivalls and Bryson	9 Ci Co-60	8 rems WB	None	Radiographer apparently forgot to retract source.	No	
2.	1/12/71	Conam Inspection	27 Ci Ir-192	13 rems WB	None	Source stuck at camera entrance because of dirt and grit in crank mechanism.	Yes, but only from rear of camera. Survey did not detect source.	Occurred at change of shift.
3.	1/27/71	Jones Testing	26 Ci Ir-192	6 rems WB	None	Two sources were in use in a permanent implant facility. Radiographer cranked out the second source instead of cranking in the first source.	Apparently not	Radiographer had no training.
4.	1971 & previous year	Newport News Shipyard	0.01 Ci Co-60 (fishpole type)	2000 to 3000 rems to hand	Uncertain, but chronic radiation dermatitis is possible from these doses	Radiography supervisor handed out source in his hands over a 29-month period.	Not applicable	
5.	7/9/71	Newport News Shipyard	220 Ci Ir-192	7 rems WB	None	A rough or kinked guide tube caused the source to jam.	No, because meter was not operating.	The radiographer disconnected the gamma alarm after the source jammed because he thought the alarm was malfunctioning.
6.	9/8/71	Pittsburgh Testing	96 Ci Ir-192	600 rems or less based on lack of symptoms	None	Not fully retracted for unknown reason.	Yes, but did not carry meter to camera.	The radiographer disconnected the guide tube before locking the camera. He instinctively reached out and touched the source when he saw it. He thought it was the safety plug.
7.	9/30/71	Peabody X-Ray Engineering	73 Ci Ir-192	5 rems WB	None	Source disconnected when it got hung up at device entrance. A worn or wrong size connector was used.	No	
8.	10/20/71	Inspection Signal Services	80 Ci Ir-192	540 rems to hand	None	Upon starting work the radiographer opened the front plug and found the source there. An incompatible control cable may have been used.	No	
9.	11/71	Conam Inspection	68 Ci Ir-192	6 rems WB	None	Source jammed.	Yes	The jammed source was discovered, but the radiographer was overexposed during the recovery operation.
10.	3/24/72	Peabody/Magnaflux	70 Ci Ir-192	21 rems WB	None	Source disconnected and stayed at end of guide tube because it had not been connected properly (GI connector).	No	The radiographer was using locking as a substitute for a survey. In this case the camera locked without the source being in.
11.	7/72	Froehling and Robertson	108 Ci Ir-192	400 to 1000 rems to hand	Reddening of hand.	Source jammed at entrance to camera, then became disconnected.	No. No survey meter was available at the site.	The radiographer called the company to report the source disconnect. They told him to shake it loose, pick it up by hand, and put it back in the camera. The radiographer thought the procedure would be dangerous and refused. By phone the company told an untrained person to do the job. He did and was overexposed.
12.	9/8/72	Magnaflux Testing Laboratory, Pittsburgh	83 Ci Ir-192	10,000 rems to hands 22 rems WB	Severe burn, loss of fingers	Forgot to retract source.	No	

13.	10/17/72	Conam Inspection	80 Ci Ir-192	8 rems WB	None	The radiographer rolled up the control cables before locking the camera. This caused the source to creep out.	Yes	
14.	12/22/72	X-Ray Engineering	38 Ci Ir-192	22,000 to 30,000 rems to fingers	Severe burn, amputation of fingers	The radiographer confused "in" and "out." He cranked the source "out" when he wanted it "in."	No	The job was at night. The radiographer was tired and was hurrying to finish the job.
15.	1973	Duriron Co.	42 Ci Ir-192	28 rems WB	None	A radiographer's assistant entered the inplant exposure room while the source was exposed. He ignored a functioning gamma alarm.	No	
16.	2/19/73	Inspection Service of Pennsylvania		5 rems WB	None	Source jammed in a crimped guide tube. Guide tube was crimped because camera had fallen earlier in the day. Pulling caused the source to disconnect.	Yes	Emergency procedures were followed, but overexposure still resulted.
17.	6/8/73	General Dynamics Electric Boat	101 Ci Ir-192	10 rems WB plus 550 rems to hip	None	Source was not quite fully retracted. A blinking warning light was ignored.	No. Survey meter was broken by a very severe blow during the work. The radiographer said he did not damage the survey meter.	There may have been a communication failure between the radiographer and his assistant, but it is also possible that she was intentionally exposed by someone.
18.	8/30/73	Universal Testing Labs, Inc.	36 Ci Ir-192	7 rems WB & 5 rems WB	None	Source crept out of the camera when it was moved without the source being locked in.	Yes	
19.	9/15/73	American Shipbuilding Co.	60 Ci Ir-192	87 rems to hand	None	An untrained person attempted to connect the source to the control cable, but did not make a connection (AI connector).	Yes	The untrained person realized the source was out, but still disconnected the guide tube.
20.	11/7/73	Consolidated X-Ray Service Co.	45 Ci Ir-192	5 rems WB	None	Camera fell over into mud pinching the guide tube, and making retraction impossible until the guide tube was straightened. The radiographer was overexposed as he straightened the guide tube.	Yes	Difficult environmental conditions contributed to the accident.
21.	12/18/73	Pittsburgh Testing Lab		7 rems WB	None	Radiographer apparently forgot to retract source.	No	
22.	1974	Midstate Inspection Engineering	25 Ci Ir-192	9 rems WB	None	An inexperienced radiographer's assistant did not fully crank in the source.	No	Poor training was a factor.
23.	1974	Dravo Corp., Ohio		175 rems to hand and 6 rems WB	None	A radiographer forgot to retract the source at the end of his work shift. The radiographer on the next shift was exposed.	No, not by the radiographer quitting work or the radiographer on the next shift.	Hurrying to quit work was a factor.
24.	4/29/74	Conam Inspection	13 Ci Co-60	7 rems WB	None	Source jammed in the guide tube near the camera because the radiographer bent it too sharply.	No	The radiographer did not understand the limitations of the guide tube.
25.	6/4/74	U. S. Testing	20 Ci Ir-192	5 rems WB	None	Unknown	Yes, but the radiographer did not understand the meter readings.	Radiographer was not properly trained in use of survey meter.
26.	10/25/74	X-Ray Industries	52 Ci Ir-192	11 rems WB and 300 rems to eye	None	Two radiographers were working together. The radiographer who was exposed thought the other radiographer had retracted the source, but he had not.	No	Poor communication was a factor. A timing buzzer rang. One radiographer shut the buzzer off but did not crank in the source. The other radiographer assumed that since the buzzer had been shut off the source had also been cranked in. But neither radiographer had cranked the source in.
27.	3/30/75	Texas Pipe Bending Co. of Puerto Rico	Ir-192	6 rems WB	None	Unknown	Unknown	

Overexposure Accidents 1971-1980

Table 2 (continued)

No.	Date	Company	Source	Dose	Symptoms	Why Was Source Exposed?	Was a Survey Made?	Other Factors
28.	11/11/75	Value Engineering Co.		28 rems WB	None	It is possible that the radiographer forgot to retract the source, but it is also possible that he intentionally exposed his badge.	Unknown	
29.	1/8/76	X-Ray Engineering		7 rems WB	None	Unknown	Unknown	
30.	2/7/76	Exam Co.	97 Ci Ir-192	5 rems WB	None	The source was not quite fully retracted for unknown reasons.	Yes, but only the back of the camera was surveyed.	The radiographer's assistant who surveyed did not know how to survey properly.
31.	4/27/76	Exam Co.	93 Ci Ir-192	6 rems WB	None	Unknown	No. Assistant did not survey.	
32.	7/8/76	NES/Conam Inspection	44 Ci Co-60 and 92 Ci Ir-192	24 rems WB, 7 rems WB, 7 rems WB	None None None	A radiographer forgot to retract the cobalt-60 source. Upon discovering his error he cranked out the iridium-192 source thinking he was cranking in the cobalt-60 source.	Surveys were erratic, not made, or not understood.	Two sets of cranks caused confusion.
33.	7/13/76	Universal Testing Laboratories, Inc.	71 Ci Co-60	6 rems WB	None	The radiographer forgot to retract the source while hurrying to finish before lunch.	Not really. The radiographer carried the meter but did not read it.	Hurrying was a factor. A gamma alarm was ringing but the radiographer shut it off.
34.	8/4/76	Globe X-Ray Services	70 Ci Ir-192	23 rems WB	None	Unknown		Unknown
35.	10/9/76	Yuba Industries	103 Ci Ir-192	6 rems WB	None	The camera was moved without being locked. Apparently the motion caused the source to creep out.	Yes	
36.	11/3/76	Arnold Green Testing Lab	30 Ci Ir-192	10 rems WB	None	Radiographer was not careful to fully retract source.	No	While working the radiographer became very ill. This led to incomplete retraction of the source and omission of the survey.
37.	11/4/76	NES/Conam Inspection, Rosemont, Illinois.	47 Ci Co-60	The actual doses to the two hands of two radiographers were probably less than 600 rems since no physical symptoms were present.	Apparently none.	A bend in the guide tube caused the source to jam near the camera.	Yes, but the back of the camera was surveyed and the exposed source was not detected.	Poor training in how to make a survey was a factor.
38.	11/12/76	Pittsburgh Des Moines Steel Company	94 Ci Ir-192	About 1000 rems to fingers of right hand based on physical symptoms and 5 rem WB.	A dry blister formed and fell off. No infection. Wound healed.	Source was not fully retracted (left 1 ft outside camera). No reason was identified.	No	
39.	12/12/76	Atlantic Research	166 Ci Co-60	1100 to 1400 rems to hand	Reddening of the skin on fingers, but no fingers were lost.	Forgot to retract source.	No. In addition, a gamma alarm in the exposure room had been disconnected so that the door could be propped open to obtain ventilation.	The radiographer had come in on Sunday morning at the company's request. His wife was in the hospital having a baby, but he did not tell the company managers. There was poor communication between the radiographer and the managers.
40.	6/16/77	J. G. Sylvester Associates, Inc.	35 Ci Co-60 and 94 Ci Ir-192	400 rems to head	None	At the end of an Ir-192 exposure, the Co-60 source was cranked out by mistake instead of cranking in the Ir-192 source.	Not really. A survey meter was carried but not looked at.	

41.	9/7/77	General Dynamics Electric Boat	80 Ci Ir-192	5 rems WB	None	Source was not fully retracted.	No. The radiographer was relying on a "chirper," but the background noise was so loud he could not hear it.	
42.	11/12/77	Pittsburgh Des Moines Steel	75 Ci Ir-192	300-600 rems to fingers	None	Source did not retract to the fully shielded position.	Yes, but the survey did not include the front of the camera.	Poor survey technique.
43.	6/3/78	Union Boiler Company	85 Ci Ir-192	120 rems to thumb	None	The radiographer retracted the source and tried to lock the camera, but the camera would not lock. He retracted the source again and tried locking, again without success. He concluded that fly ash had jammed the locking mechanism.	Yes. The meter needle read off scale, but an audible speaker was silent. The radiographer concluded that moisture and fly ash had shorted the meter causing the needle to go off scale.	
44.	11/15/78	Twin City Testing Engineering Lab	Ir-192	22 rems to trunk (lower back of body)	None	The source was not fully retracted for unknown reasons.	Yes, but the survey was not complete enough to show that the source was not fully retracted.	
45.	3/7/79	Townsend and Bottum, Inc.	65 Ci Ir-192	9 rems to left calf	None	The source was retracted but not fully, perhaps because of a tight bend in the guide tube. One more turn of the crank was needed.	Yes, but not carefully.	Work being done late at night. Heavy work load. Radiographer distracted and worried by phone call from supervisor.
46.	10/10/79	Consolidated X-Ray Service Co.	Ir-192	9 rems WB	None	The source was retracted and the locking mechanism did not catch the locking ball. This allowed the source to move out of the fully shielded position when the control cable was coiled.	Yes, but the source crept out after the survey had been made.	
47.	12/13/79	Tulsa Gamma Ray, Inc.	80 Ci Ir-192	17 rems on film badge	Probably none, but individual could not be located afterwards.	Intentional exposure.	Not applicable.	The individual had been fired the day before the exposure for being drunk on the job after working for the licensee for 7 days. He returned drunk the next morning, cranked out the source, and handed his film badge to the supervisor. It is not known whether he was exposed or whether just the film badge was exposed.
48.	6/12/80	Consumers Power	55 Ci Ir-192	8 rems WB	None	The crank assembly apparently jammed so that the source was not fully retracted, unknown to the radiographer.	Yes, but the assistant radiographer did not survey the front of the camera.	

*Source: Compiled by the author from letters and reports contained in the files of the NRC's Office of Inspection and Enforcement.

NOTE: No overexposures greater than 5 rems to the whole body (WB) or 75 rems to the extremities were reported to the NRC by its radiography licensees for the period January 1, 1981, through August 31, 1981. However, two people involved in manufacturing radiography sources suffered serious damage to their hands during this period.



Chapter 1

1. Charles W. Briggs, "Developments in Gamma Ray Radiography, 1928-1941," *Industrial Radiography*, Vol. 1, Summer 1942, p. 7. (Reprinted in *Materials Evaluation*, Vol. 39, pp. 356-359, March 1981.)
2. Clyde B. Clayson, "Gamma Ray Testing of Welds," *Industrial Radiography*, January 1943, p. 17.

Chapter 2

1. National Council on Radiation Protection and Measurements, *Natural Background Radiation in the United States*, NCRP Report No. 45, Washington, D.C., 1975.

This is considered the most authoritative source of information on natural background radiation in the United States. The doses given in Chapter 2 are appropriate for most body organs, including bone marrow, gastrointestinal tract, and gonads. Doses to the bone surface are 120 mrem/year and to the lung are 180 mrem/year.

2. National Council on Radiation Protection and Measurements, *Radiation Exposure From Consumer Products and Miscellaneous Sources*, NCRP Report No. 56, Washington, D.C., 1977.

This reference gives the dose from natural radioactivity in building materials. This dose could be classified as either natural or manmade. It seemed more appropriate to consider it to be natural background radiation to us.

3. Merrill Eisenbud, *Environmental Radioactivity*, Academic Press, New York, 1973, pp. 199-204.

4. B. Schleien, T. T. Tudser, and D. W. Johnson, "The Mean Active Bone Marrow Dose to the Adult Population of the United States from Diagnostic Radiology," *Health Physics*, Vol. 34, p. 587, June 1978.

We believe this is the most authoritative study of radiation exposure in the United States from medical and dental diagnostic x-rays. The study estimates a dose of 77 mrem per year to active bone marrow to the U.S. population in 1970. Active bone marrow is used because this is considered to be the dose most relevant to cancer induction. The dose received is averaged over the active bone marrow in the entire body. Thus, dental x-rays, which give a high dose to a small part of the body, contribute only 3 mrem per year when averaged over the entire body's active bone marrow.

If only adults are considered, the U.S. average dose from diagnostic x-rays is 103 mrem per year because adults receive more x-rays than children.

The dose to the gonads is often calculated because it is the genetically significant dose. The gonad dose from diagnostic x-rays is 20 mrem/year according to the Bureau of Radiological Health. This is lower than the active bone marrow dose because the gonads are not often in the direct x-ray beam and because the genetically significant gonadal dose is reduced to account for the proportion of a person's reproduction that has passed. Older people, who receive most x-rays, will have few additional children, so their genetically significant gonadal dose is small.

Thus, in comparing these estimates with other estimates, it is necessary to consider (1) does the estimate apply to the whole body or to some specific organ such as the lungs? (2) does the estimate apply to the total population or to adults only? and (3) is the dose estimate weighted for cancer significance or genetic significance?

5. U.S. Environmental Protection Agency, *Radiological Quality of the Environment*, EPA Report EPA-520/1-77-009, Washington, D.C., 1977.

To determine total medical dose, the dose from radioactive materials injected into the body for diagnostic purposes must be added to the dose from diagnostic x-rays. The U.S. Environmental Protection Agency has estimated that this source of radiation adds roughly 20% to the medical x-ray dose.

The value for fallout from nuclear weapons tests is also from the above EPA report.

6. Interagency Task Force on the Health Effects of Ionizing Radiation, *Report of the Work Group on Exposure Reduction*, U.S. Department of Health, Education, and Welfare, 1979.

The value of 0.3 mrem per person per year from nuclear power is taken from this reference. About two-thirds of the dose comes from radioactive radon-222 gas that escapes from piles of uranium ore either before or after the uranium has been extracted. About 80% of the remainder comes from reprocessing of spent nuclear fuel. The operation of nuclear power plants contributes very little to the dose.

7. National Council on Radiation Protection and Measurements, *Radiation Exposure from Consumer Products and Miscellaneous Sources*, NCRP Report No. 56, Washington, D.C. 1977.

The value of 1 mrem/year for consumer products, exclusive of building materials (which we listed as natural background radiation), is from this reference.

8. B. Brooks, S. McDonald, and E. Richardson, *Occupational Radiation Exposure — Eleventh Annual Report — 1978*, NRC Report NUREG-0593, 1981.

The average dose of 1.3 rem for radiographers is on page 60.

9. The standard practice with personnel dosimeters is to subtract natural background radiation by subtracting the reading on a control dosimeter. This subtracts radiation dose from natural background sources, from radiation received while in transit, and from thermal fogging of film. This procedure is followed by R. S. Landauer (per Robert Wheeler), Eberline (per Eric Geiger), and Seamans (per Robert Pollock).

10. Reports to the NRC of radiographers using personnel monitoring tend to exaggerate the number of people working as radiographers and tend to greatly underestimate the dose received by an actively working radiographer. For example, in 1978 an NRC radiography licensee (Bethlehem Steel, Steelton, Pennsylvania) reported 27 people monitored of whom 25 had no measurable exposure. The other 2 had exposures under 100 mrem. Anthony Lamastra of Bethlehem Steel said that of the 27 monitored only about 5 or 6 were authorized to work with the licensee's one radioactive source. The others were monitored because they worked in a department with a cabinet x-ray machine. The licensee estimated that in 1978 only about 10 shots had been made and that less than 10 staff-hours of work was spent using the radioactive gamma source during the year. Situations

like this greatly lower the average dose received by radiographers.

The average annual dose reported by the NRC for radiographers is well below the dose that can be expected by a field radiographer working regularly for a year.

11. Reports from NRC licensees (such as in Reference 8) show that almost 1000 radiographers receive doses exceeding 1 rem each year. The NRC had about 360 gamma radiography licenses outstanding in 1978. Agreement States issued about 681 (as of December 1979, NRC Office of State Programs unpublished report, "Licensing Statistics and Other Data").

States where extensive field radiography is performed tend to be Agreement States. This is because the major oil producing states are Agreement States and field radiography is performed extensively in connection with the oil industry. NRC licensees are more likely to do in-plant radiography in factories in the Midwest and Northeast. Higher doses are associated with field radiography because shielding walls are not available. From these facts, we estimate that roughly 3000 to 4000 radiographers received doses exceeding 1 rem per year.

12. Centaur Associates, Inc., "An Economic Study of the Radio-nuclides Industry," unpublished report submitted to the NRC, February 15, 1980.

This report estimated 4500 gamma radiographers directly involved in making radiographs in the U.S. (both NRC and Agreement State licensed) in 1978, based on a survey of licensed companies. (A summary of this information is on page 60 of Reference 8.) Our own feeling is that the estimated number of 4500 radiographers is an underestimate and does not include people who occasionally work as radiographers. We have rather arbitrarily increased their estimate to 10,000 people to account for these. The value seems a reasonable compromise between the 4500 in Reference 11 and the 13,000 monitored by NRC licensees plus an estimated 26,000 monitored by state licensees of which 6700 had measurable radiation doses (Reference 8). Independently, John Munro of Tech/Ops, Inc., also concluded that there were about 10,000 radiographers in the U.S.

13. United Nations Scientific Committee on the Effects of Atomic Radiation (UNSCEAR), *Sources and Effects of Ionizing Radiation*, United Nations, New York, 1977, p. 263. (This is often called the "1977 UNSCEAR Report".)

Based on NRC reports of doses received by workers who terminated employment, these estimates were obtained:

Length of Employment (years)	5-10	10-15	15-20
Estimated Lifetime Dose (rems)	19	14	14

We have rounded these numbers off to 20 rems lifetime dose.

Chapter 3

1. C. Michael Lederer and Virginia S. Shirley, Eds., *Table of Isotopes*, Seventh Edition, John Wiley and Sons, Inc., New York, p. 1231, 1978.

There are about 2.23 gamma rays per disintegration of iridium-192, according to this reference.

2. From January 1979 through July 1981, NRC licensees reported three leaking sources to NRC, according to Samuel Pettijohn, NRC, Office for Analysis and Evaluation of Operational Data, and Earl Wright, NRC, Office of Nuclear Material Safety and Safeguards.

3. NRC Office of Inspection and Enforcement, "Preliminary Notification of Event or Unusual Occurrence," PNO-I-80-106, July 22, 1980, and information supplied by John E. Glenn, NRC, Region I Office, 1981.

Chapter 4

1. Percy Brown, *American Martyrs to Science through the Roentgen Rays*, Charles C. Thomas, Springfield, Illinois, 1936.

2. Daniel S. Grosch and Larry E. Hopwood, *Biological Effects of Radiation*, Second Edition, Academic Press, New York, pp. 3 and 4, 1979.

But contrary to the description in the book, Becquerel was burned by radium, not uranium, according to Frederick G. Spear, *Radiation and Living Cells*, Chapman and Hall, 1953.

3. Eugene L. Saenger, James G. Kereiakes, Neil Wald, and George E. Thomas, "Clinical Course and Dosimetry of Acute Hand Injuries to Industrial Radiographers from Multicurie Sealed Gamma Sources," *The Medical Basis for Radiation Accident Preparedness* (Karl F. Hubner and Shirley A. Fry, editors), Elsevier/North-Holland, New York, pp. 169-178, 1980.

The description of the symptoms of radiation burns was taken from this reference. Information on chronic radiodermatitis is from:

Wright H. Langham, editor, *Radiological Factors in Manned Space Flight*, National Academy of Sciences — National Research Council, pp. 147-157, 1967.

4. Joseph F. Ross, Francis E. Holly, Harvey A. Zarem, Cappy M. Rothman, and Alan L. Shabo, "The 1979 Los Angeles Accident: Exposure to Iridium-192 Industrial Radiographic Source," *The Medical Basis for Radiation Accident Preparedness* (Karl F. Hubner and Shirley A. Fry, eds.), Elsevier/North-Holland, New York, pp. 205-221, 1980.

5. F. Eugene Holly and William L. Beck, "Dosimetry Studies for an Industrial Radiography Accident," *The Medical Basis for Radiation Accident Preparedness* (Karl F. Hubner and Shirley A. Fry, editors) Elsevier/North-Holland, New York, pp. 265-277, 1980.

6. This incident is the same as discussed in NUREG/BR-0001, Volume 1, Case History 4. That report was based on preliminary information. The later studies above estimated the source strength to be 28 curies (rather than 40 curies), and the time in the worker's back pocket to be 45 minutes (rather than 2 hours). The dose to the surface of the skin cannot be precisely determined because the dose depends very strongly on the precise distance between the source and the worker's skin.

Based on Figure 3 in Reference 5 and an assumed 1 centimeter distance, the skin surface dose would be very roughly 20,000 rem (rather than 1.5 million rem). Dose estimates of up to 1 million rems can be calculated for a single point on the surface of the skin if one as-

sumes the source was touching the skin. However, we considered 20,000 rems a more reasonable estimate for estimating actual damage to a piece of skin of significant size. Radiation doses above 3000 rems cause complete destruction of tissue.

7. M. Annamalai, P. S. Iyer, and T. M. R. Panicker, "Radiation Injury from Acute Exposure to an Iridium-192 Source: Case History," *Health Physics*, Vol. 35 (Aug.), pp. 387-389, 1978.

8. D. Beninson, A. Placer, and E. Vander, "Estudio de un caso de irradiación humana accidental," *Proceedings of the Symposium on the Handling of Radiation Accidents*, IAEA, Vienna, pp. 415-429, 1969.

9. K. Z. Morgan and J. E. Turner, *Principles of Radiation Protection*, John Wiley and Sons, Inc., New York, Chapters 12 and 13, 1967.

10. International Commission on Radiological Protection, *The Principles and General Procedures for Handling Emergency and Accidental Exposures of Workers*, ICRP Publication 28, Pergamon Press, Oxford, p. 16, 1977.

11. Ye Gen-yao, Liu Yong, Tien Nue, Chaing Ben-yun, Chien Feng-wei, and Yiaie Chien-ling, "The People's Republic of China Accident in 1963," *The Medical Basis for Radiation Accident Preparedness* (Karl F. Hubner and Shirley A. Fry, editors), Elsevier/North-Holland, New York, pp. 82-89, 1980.

12. R. J. P. Le Go, M. T. Deloy, J. L. Malarbet, M. Veyrat, "Clinical and Biological Observations of Seven Accidentally Irradiated Algerian Persons," Report of the French Commissariat à l'Énergie Atomique, CEA-CONF-4659, 1979.

13. Reference 9, p. 54.

14. Information on how the source was left with the watchman was obtained from Dr. Julián Sánchez-Gutiérrez, Director, Safety of Nuclear Facilities, Commission Nacional de Seguridad Nuclear y Salvaguardias, Mexico City, Mexico.

15. *Vital Statistics of the United States - 1977*, Volume II-Mortality, U.S. Department of Health and Human Services, Public Health Service, Table 7-5, 1980.

The respiratory diseases include influenza, pneumonia, bronchitis, emphysema, and asthma.

16. The following three reports written by committees of eminent scientists are basically in agreement on the upper limit of risk of cancer death:

"The BEIR III Report": *The Effects on Populations of Exposure to Low Levels of Ionizing Radiation*, Report of the Committee on the Biological Effects of Ionizing Radiation, National Academy of Sciences, Washington, 1980.

"The UNSCEAR Report": *Sources and Effects of Ionizing Radiation*, United Nations Scientific Committee on the Effects of Atomic Radiation, UN Publication E.77.IX.1, New York, 1977.

"ICRP 26": *Radiation Protection, Recommendations of the International Commission on Radiological Protection*, ICRP Publication 26, Pergamon Press, Oxford, 1977.

17. *Accident Facts*, National Safety Council, 1979.

Career lifetime accidental deaths are calculated by using annual death rates multiplied by an assumed working lifetime of 40 years.

18. R. L. Gotchy, "Estimation of Life Shortening from Radiogenic Cancer per Rem of Absorbed Dose," *Health Physics*, Vol. 35, pp. 563-565, October 1978.

Dr. Gotchy states, "One would expect the life shortening of occupationally exposed workers in the nuclear industry to lie between 0.63 and 1.2 days per rem. However, it should be noted that such upper bound estimates may be high by up to a factor of 5 for low dose rates (less than 4 rem/day)..."

19. The EPA estimated 12 to 18 years in their "Background Report — Proposed Federal Radiation Protection Guidance for Occupational Exposure," Office of Radiation Programs, U.S. Environmental Protection Agency Report EPA 520/4-81-003, p. 67, January 16, 1981.

We have rounded their range off to 15 years loss of life caused by radiation-induced cancer. Calculations by Charles Willis of the NRC yield the same result.

20. Bernard L. Cohen and I-Sing Lee, "A Catalog of Risks," *Health Physics*, Vol. 36, pp. 707-722, June 1979.

21. Toxic Substances Strategy Committee, *Toxic Chemicals and Public Protection*, Council on Environmental Quality, Washington, D.C., p. xiii, 1980.

CEQ estimates that roughly 20% of all cancer deaths are associated with carcinogens in the workplace. Twenty percent of 2,000 cancers per 10,000 people equals 400 cancers per 10,000 workers. This is a very rough estimate.

22. UNSCEAR Report (Reference 16), 1977, p. 429.

23. International Commission on Radiological Protection, *Problems Involved in Developing an Index of Harm*, ICRP Publication 27, Pergamon Press, New York, paragraphs 33 and 49, 1977.

24. Data from Mr. Edwin Silverberg, American Cancer Society, New York, 1980.

25. T. F. Mancuso, A. Stewart, and G. Kneale, "Radiation Exposures of Hanford Workers Dying from Cancer and other Causes," *Health Physics*, Vol. 33, pp. 369-385, 1977.

T. Najarian and T. Colton, "Mortality from Leukemia and Cancer in Shipyard Nuclear Workers," *Lancet*, Vol. 1, pp. 1018-1020, 1978.

Several scientists, such as those listed above, have claimed that the generally accepted estimates of cancer risk underestimate that risk. If their estimates are right, our estimates of cancer risk would be too low. But radiation risks would still not exceed the risks in many other occupations.

Chapter 5

1. American National Standard N432, "Radiological Safety for the Design and Construction of Apparatus for Gamma Radiography," National Bureau of Standards Handbook 136, U.S. Government Printing Office, Washington, D.C., paragraph 8.1.2, 1981.

2. Gamma rays are assumed to have been "hardened" by already passing through a tenth-value thickness.

3. John J. Munro, III, and Frances E. Roy, Jr., *Gamma Radiography: Radiation Safety Handbook*, Tech/Ops, Inc., Radiation Products Division, 40 North Avenue, Burlington, Massachusetts 01803, 1981.

The density of tungsten is 17.8 grams/cm³, the density of concrete is 2.35 grams/cm³, the density of steel or iron is 7.8 grams/cm³, the density of lead is 11.34 grams/cm³, and the density of uranium is 18.7 grams/cm³.

Chapter 6

1. *Applied Ergonomics Handbook*, ICP Sciences and Technology Press Limited, Surrey, England, p. 19, 1974.

2. Ernest J. McCormick, *Human Factors in Engineering and Design*, 4th edition, McGraw-Hill, New York, p. 69, 1976.

3. Harold P. Van Colt and Robert G. Kinkade, editors, *Human Engineering Guide to Equipment Design*, revised edition, American Institute for Research, Washington, D.C., pp. 82 and 298, 1972.

4. NRC Regulatory Guide 8.28, "Audible-Alarm Dosimeters."

This guide discusses selection and proper use of audible-alarm dosimeters.

Chapter 8

1. "NRC's Jurisdiction Over Persons Using Byproduct, Source and Special Nuclear Material in Off-shore Waters Beyond Agreement States' Territorial Waters," proposed rule, *Federal Register*, Vol. 45, p. 71807, October 30, 1980.

Chapter 9

1. 49 CFR Section 177.825(a), effective February 1, 1982, requires placarded trucks to follow routes that minimize radiological risks. Since the greatest radiological risk from radiography cameras is the risk of delayed effects of radiation to the driver and passengers of the truck, the truck should take the quickest route to the work site.

2. Case 27, "Case Histories of Radiography Events," NRC Report, NUREG/BR-0001, Vol. 1, 1980.

Chapter 10

1. The emergency drills at Norfolk Naval Shipyard were under the direction of John Martin, formerly radiation safety officer at Norfolk Naval Shipyard, now with Oak Ridge Operations Office, Department of Energy.

2. Appendix F shows that in the 10 years from 1971 to 1980, the NRC has received only 3 reports of a radiographer being overexposed to more than 5 rems to the whole body or 75 rems to the hands during source recovery operations.

Chapter 11

1. In replying anonymously to a questionnaire, 80% of the radiographers replying said they surveyed always or most of the time. Twenty percent said they surveyed when being watched. The questionnaire was submitted to 40 field radiographers in the International Union of Operating Engineers, Local 2. The questionnaire was prepared by the University of Lowell. John Munro of Tech/Ops, Inc., thinks that surveys are made in most instances. Ron Wascum of the Louisiana State program estimates 70% to 80% of the surveys are made. Mike McCormack of Chicago Bridge and Iron estimates almost 100% compliance in his company, stating that he would discharge any radiographer who did not use his survey meter.



Photo Credits and Acknowledgments

Photo Credits

Chapter 1:

- Figures 2, 3, and 4 Deutsches Röntgen-Museum, Remscheid, Germany.
- Figure 5 U.S. Atomic Energy Commission, *Understanding the Atom Series, Atomic Pioneers, Book 2, From the Mid-19th to the Early 20th Century*, Ray and Roselyn Hiebert, 1971.
- Figure 6 *The Welding Engineer*, Sept. 1942, page 35.
- Figures 7, 8, and 10 Tech/Ops, Inc., Burlington, Massachusetts.

Chapter 2:

- Figure 3 Philips Electronic Instruments, Inc.
- Figure 5 The Royal Society, London (from C.T.R. Wilson, "Investigations on X-Rays and β -Rays by the Cloud Method," *Proceedings of the Royal Society*, Volume A104, page 1, August 1923).
- Figure 9 Gamma Industries, Baton Rouge, Louisiana.
- Figure 11 Dr. Eduardo Penna-Franco and Dr. M. Emmerich, Universidade Federal do Rio de Janeiro, Brazil.

Chapter 3:

- Figures 2 and 6 Tech/Ops, Inc., Burlington, Massachusetts.

Chapter 4:

- Figure 1 Oliver and Boyd, Publishers, Edinburgh, Scotland (from W. F. Harvey, "Review of Irradiation Effects on Cells and Tissues of the Skin," *Edinburgh Medical Journal*, Volume XLIX, No. 9, Sept. 1942, pages 529-552 and following plates.)
- Figure 2 Dr. Eugene Saenger, Cincinnati, Ohio (from NUREG/BR-0001, Vol. 1., 1980).
- Figure 3 H. Jammet, Commissariat A L'Energie Atomique, Fontenay-Aux-Roses, France (from "The 1978 Algerian Accident: Acute Local Exposure of Two Children," *The Medical Basis for Radiation Accident Preparedness*, Elsevier/North-Holland, Inc., New York, p. 240, 1980.)
- Figures 4 through 7 Dr. Joseph F. Ross, UCLA School of Medicine, Los Angeles, California and Mr. Don D. Honey, California Department of Health Services, Sacramento, California.
- Figure 8 Michael and Grace McGuire.
- Figures 10 and 11 Professor Maurice H. F. Wilkins, Biophysics Department, King's College, London, England.
- Figure 12 Dr. William F. Brandom, University of Denver, Colorado.
- Figure 17 Damon Willis
- Figure 18 Dr. Paul Selby, Oak Ridge National Laboratory, Oak Ridge, Tennessee (from Gary O. Fullerton, et al., eds., *Biological Risks of Medical Irradiations*, American Institute of Physics, New York, p. 9, 1980).

- Chapter 5:**
- Figures 2-3 and 2-4 Gulf Nuclear, Webster, Texas.
 - Figures 2-2, 9-1, 9-2, and 9-4 Industrial Nuclear Corp., Foster City, California.
 - Figure 9-3 Ray Fujimoto, Radiation Protection Bureau, Department of National Health and Welfare, Ottawa, Canada.
 - Figures 10 and 15 Gamma Industries, Baton Rouge, Louisiana.
 - Figures 11 and 12 Tech/Ops, Inc., Burlington, Massachusetts.
 - Figure 13 Bethlehem Steel Corp., Sparrows Point Shipyard, Baltimore, Maryland.
- Chapter 6:**
- Figure 2 Dosimeter Corporation of America, Cincinnati, Ohio.
 - Figures 6 and 7 Source Production and Equipment Corporation, Kenner, Louisiana.
 - Figure 8 Tech/Ops, Inc., Burlington, Massachusetts.
 - Figures 9 and 10 Dosimeter Corporation of America, Cincinnati, Ohio.
 - Figures 11 and 12 Siemens Health Physics Services, Des Plaines, Illinois.
 - Figure 13 Roger Broseus, National Institutes of Health, Bethesda, Maryland.
 - Figures 14 and 15 Robert Fox, Battelle-Pacific Northwest Laboratories, Richland, Washington.
 - Figure 16 Gamma Industries, Baton Rouge, Louisiana.
- Chapter 7:**
- Figures 17, 18, and 19 Bethlehem Steel Corp., Sparrows Point Shipyard, Baltimore, Maryland.
 - Figures in problems Eberline Instrument Corporation, Santa Fe, New Mexico, and Dosimeter Corporation of America, Cincinnati, Ohio.
 - Figures 1 and 2 Industrial Nuclear Corp., Foster City, California.
 - Figures 3, 5, and 6 Gamma Industries, Baton Rouge, Louisiana.
 - Figures 7 and 8 Tech/Ops, Inc., Burlington, Massachusetts.
 - Figures 9 and 10 Bethlehem Steel Corp., Sparrows Point Shipyard, Baltimore, Maryland.
- Chapter 8:**
- Figure 3 Source Production and Equipment Corporation, Kenner, Louisiana.
 - Figures 5, 6, 7, 8, 9, 10, 11, 14, and 15. Bethlehem Steel Corp., Sparrows Point Shipyard, Baltimore, Maryland.
 - Figure 12 Dosimeter Corporation of America, Cincinnati, Ohio.
 - Figure 13 Gulf Nuclear, Webster, Texas.
 - Figure 16 Tech/Ops, Inc., Burlington, Massachusetts.
- Chapter 9:**
- Figures 1 and 7 Tech/Ops, Inc., Burlington, Massachusetts.
 - Figures 2, 9, 10, and 11 Roger Broseus, National Institutes of Health, Bethesda, Maryland.
 - Figures 3, 4, 5, and 6 Gamma Industries, Baton Rouge, Louisiana.

Credits and Acknowledgments



Chapter 10:

- Figures 8, 12, and 15 Automation Industries, Phoenixville, Pennsylvania.
- Figure 13 Gulf Nuclear, Webster, Texas.
- Figure 14 Bethlehem Steel Corp., Sparrows Point Shipyard, Baltimore, Maryland.
- Figure 1 Bethlehem Steel Corp., Sparrows Point Shipyard, Baltimore, Maryland.
- Figure 4 Tech/Ops, Inc., Burlington, Massachusetts.

Chapter 11:

- Figures 1 and 2 Bethlehem Steel Corp., Sparrows Point Shipyard, Baltimore, Maryland.
- Figure 3 Tech/Ops, Inc., Burlington, Massachusetts.
- Figure 4 Gamma Industries, Baton Rouge, Louisiana.
- Figure 5 Don Honey, California Department of Health Services, Sacramento, California.

Acknowledgments

We would like to thank the following people for helping us prepare this manual:

Dr. James Phelps and Dr. José Martín of the Nuclear Engineering Department of the University of Lowell, Lowell, Massachusetts, for providing much useful information in the early drafts of many of the chapters.

The students and staff of the Lowell Vocational Technical High School, Lowell, Massachusetts, for reviewing the draft manual and evaluating its understandability.

Anthony Lamastra, Gary Rusinovich, and Clarence Snyder of Bethlehem Steel Corporation for taking a series of illustrative photographs at our request.

John Munro of Tech/Ops, Inc., Burlington, Massachusetts, for providing many photographs, the data for the shielding attenuation curves, and many useful comments.

Dr. Harry Richardson of Gamma Industries, Baton Rouge, Louisiana, for providing many photographs and many useful comments.

Walter Peeples of Gulf Nuclear, Webster, Texas, for taking photographs that we requested and for comments on the manual.

Mike Santoro of Automation Industries, Phoenixville, Pennsylvania, for taking photographs that we requested.

Richard DiCharry of SPEC, Kenner, Louisiana, for providing us with a number of photographs that we requested.

Thomas Gaines of Industrial Nuclear Corp., Foster City, California, for taking photographs that we requested.

Al Zirkes of Dosimeter Corporation of America, Cincinnati, Ohio, for taking photographs that we requested.

Eric Geiger of Eberline Instrument Corporation, Santa Fe, New Mexico, for supplying photographs we requested.

Roger Broseus, National Institutes of Health, Bethesda, Maryland, for helping us obtain several photographs.

Ron Wascum of the Louisiana Nuclear Energy Division for useful comments.

Don Honey of the California State Department of Health Services for his help in making available for our use photographs of the injury from the 1979 California radiography accident.

Ed Bailey of the Texas Department of Health for useful comments.

F. Bruce Kovacs of Foster Wheeler Energy Corporation for helpful discussions and demonstrations of radiography.

The staff of the NRC who reviewed and commented on drafts of the manual, especially Robert Alexander, Nathan Bassin, Jack Bell, Steve Bernstein, Allen Brodsky, Thomas Dorian, Karl Goller, Al Grella, James Jones, Ralph Jones, Joel Lubenau, Ralph Meyer, Jack Nehemias, Al Roecklein, Bernard Singer, Don Smith, Mike Wangler, Lorenzo Wilborn, and Charles Willis.

The staff of the NRC library, who did an excellent job of tracking down numerous references, many particularly obscure: Margaret Conyngham, Mary Ann Neel, Eileen Chan, and Ursula McKinney.

Dr. Janet Turnage, industrial psychologist, Orlando, Florida, who was an NRC consultant and who provided many helpful suggestions.

Barbara Brooks of NRC for helping to collect data on overexposure accidents.

Janet Thot-Thompson of NRC for the design, art direction, and production guidance for this manual. Lionel Watkins and John Orban of NRC for artwork, illustrations, page layout, and camera-ready art. Alvin Blunt and Alicia Ong of NRC for help in final production.

Ann Beranek of NRC for editorial and proofreading help throughout the draft and final production stages of this project.

Marshel D. Baggett of NRC for guidance and help in the final production stages of this manual.

Dan Dehn, NRC photographer, for taking photographs and making prints.

The NRC Typing Unit for typing and retyping the many drafts of this manual: Jeannette Kiminas, Chief, Carol Finan, Charline Simon, and Rita Prather.