

# **LEGIBILITY NOTICE**

A major purpose of the Technical Information Center is to provide the broadest dissemination possible of information contained in DOE's Research and Development Reports to business, industry, the academic community, and federal, state and local governments.

Although a small portion of this report is not reproducible, it is being made available to expedite the availability of information on the research discussed herein.

CONF-8706157- - |

Los Alamos National Laboratory is operated by the University of California for the United States Department of Energy under contract W-7405-ENG-36

LA-UR--87-2017

DE87 011772

TITLE EVALUATING AND TESTING THERMOGRAPHIC PHOSPHORS FOR TURBINE-ENGINE TEMPERATURE MEASUREMENTS

AUTHOR(S) B. W. Noel, S. W. Allison, D. L. Beshears, M. R. Cates, H. M. Borella, L. A. Franks, C. E. Iverson, S. S. Lutz, B. R. Marshall, M. B. Thomas, W. D. Turley, L. J. Dowell, G. T. Gillies, and W. N. Lutz

SUBMITTED TO AIAA/SAE/ASME/ASEE 23rd Joint Propulsion Conference

DISCLAIMER

This report was prepared as an account of work sponsored by an agency of the United States Government. Neither the United States Government nor any agency thereof, nor any of their employees, makes any warranty, express or implied, or assumes any legal liability or responsibility for the accuracy, completeness, or usefulness of any information, apparatus, product, or process disclosed, or represents that its use would not infringe privately owned rights. Reference herein to any specific commercial product, process, or service by trade name, trademark, manufacturer, or otherwise does not necessarily constitute or imply its endorsement, recommendation, or favoring by the United States Government or any agency thereof. The views and opinions of authors expressed herein do not necessarily state or reflect those of the United States Government or any agency thereof.

By acceptance of this article, the publisher recognizes that the U.S. Government retains a nonexclusive, royalty-free license to publish or reproduce the published form of this contribution or to allow others to do so for U.S. Government purposes.

The Los Alamos National Laboratory requests that the publisher identify this article as work performed under the auspices of the U.S. Department of Energy.

DISTRIBUTION OF THIS DOCUMENT

Los Alamos Los Alamos National Laboratory Los Alamos, New Mexico 87545

MASTER



# EVALUATING AND TESTING THERMOGRAPHIC PHOSPHORS FOR TURBINE-ENGINE TEMPERATURE MEASUREMENTS

by

**B. W. Noel\***

*Los Alamos National Laboratory*

*Los Alamos, NM 87545*

S. W. Allison,<sup>§</sup> D. L. Beshears,<sup>§</sup> M. R. Cates<sup>§</sup>

*Oak Ridge Gaseous Diffusion Plant*

*Oak Ridge, TN 37831*

H. M. Borella,<sup>¶</sup> L. A. Franks,<sup>†</sup> C. E. Iverson,<sup>†</sup> S. S. Lutz,<sup>‡</sup>

B. R. Marshall,<sup>‡</sup> M. B. Thomas,<sup>\*\*</sup> W. D. Turley<sup>§§</sup>

*EG&G Energy Measurements, Inc.*

*CA 93117*

L. J. Dowell,<sup>¶¶</sup> G. T. Gillies,<sup>††</sup> and W. N. Lutz<sup>¶¶</sup>

*University of Virginia*

*VA 22901*

## ABSTRACT

A technique developed earlier for measuring the temperature of inaccessible surfaces in low-temperature rotating machines is being adapted to measure the temperature of surfaces at the higher temperatures and in the erosive environment inside operating turbine engines. The method uses the temperature dependence of the characteristic decay time of the laser-induced-fluorescence of thermographic phosphors to measure the temperature. This paper summarizes recent work in four areas: phosphor characterization and calibration, instrumentation development, bonding, and field tests. By using improved instrumentation and data-analysis techniques, we measured calibration curves for several phosphors with greater accuracy and extended them to higher temperatures than before. We evaluated phosphors that were attached to sample surfaces by high-temperature bonding materials, electron-beam deposition, flame spraying, and plasma spraying. We performed a burner-rig test on some phosphor-coated samples and designed, built, and calibrated the instrumentation required for an upcoming spin-pit test.

- 
- Staff Member
  - § Development Staff Member
  - ¶ Scientific Specialist III
  - † Assistant Program Manager
  - ‡ Scientific Specialist I
  - \*\* Engineer I
  - §§ Scientist III
  - ¶¶ Graduate Research Assistant
  - †† Research Assistant Professor

## Introduction

We recently developed a technique for remotely measuring the temperature in rotating machines, such as developmental motors, electrical-power-generating turbines, and gas centrifuges. More recently, we have been adapting it for use in the higher-temperature, erosive environment in operating turbine engines.<sup>1</sup> The goal of the present work is to field, in an operating engine, a prototype temperature probe that will measure surface temperatures on first-stage rotor blades or stator vanes or both.

## Review of the Technique

Certain materials—called thermographic phosphors—(TPs) show unique and useful temperature dependence of the fluorescence that results from uv (or higher-energy) excitation. There are basically two techniques for measuring temperature using TPs. One of them uses the ratio of temperature-dependent spectral-emission lines. The other, which uses the characteristic decay time of those lines, seems to be the best one for rotating or otherwise periodically moving surfaces.

The basic idea is that one can do remote thermometry on either moving or stationary objects by observing the temperature dependence of the fluorescence emitted by TPs. The phosphor is bonded to the surface to be measured, and is presumably at the same temperature or, if not, it is assumed to be possible to correct any differential. The TP is then excited by uv (or higher-energy) radiation. This results in the emission of visible light comprised of groups of narrow spectral lines whose properties vary with temperature. Appropriate spectral lines are selected with optical filters and the fluorescence is detected and analysed by suitable instruments. Both the amplitude and the characteristic-decay time following pulsed excitation decrease monotonically with temperature above a "quenching" temperature. Below the quenching temperature, those properties are constant or increasing. We use the characteristic-decay time to measure the temperature.

## TP Characterization and Calibration

Virtually all of the TPs studied so far are ceramics that are rare-earth-doped Group III metal oxides

and oxysulfides, but we are also studying garnets and Group II metal-doped fluorogermanates. Table I lists some basic information about all of the TPs we have studied so far in their powder form. The table shows that the TPs' usefulness as remote temperature monitors extends over the range from below -200 (La<sub>2</sub>O<sub>2</sub>S:Eu) to at least +1200°C (Y<sub>2</sub>O<sub>3</sub>:Eu and perhaps others). The upper temperature limit shown usually results from the emission becoming too dim to be detected with our experiment setup. But some of the oxysulfide TPs begin to disintegrate at higher temperatures. So the upper limit of their temperature range may result from either effect. The limit shown for Y<sub>2</sub>O<sub>3</sub>:Eu is a result of the temperature limit of the laboratory oven; we expect to extend the temperature range using a newly acquired 1700°C oven. A few of the TP's temperature ranges have not yet been sufficiently well established to list them on the table. The emission spectra (luminescence intensity as a function of wavelength) spectra were all taken with the materials excited by uv light. In most cases, the excitation wavelength was 337 nm, from a nitrogen laser. The excitation spectra are taken by holding the detected wavelength constant at one of the important emission lines while varying the excitation wavelength.

Table II lists those TPs that have had their decay times measured or that have been temperature-cycled, or both. In most cases, these TPs have been deposited on IN-100 substrates after being mixed with a binder, as shown in the table, or have been deposited directly by a mechanical deposition method. The decay times listed are all within the range of readily detectable signals. Temperature cycling causes adverse effects in a few cases. These are currently being studied for explanations. The precision values of three TPs were established by making isothermal measurements. The oven was set at a fixed temperature, decay-time measurements were repeated ten times, and the results were analysed statistically. The resulting two-sigma values are: La<sub>2</sub>O<sub>2</sub>S:Tb, ±2° F at 300° F; YVO<sub>4</sub>:Dy, ±6° F at 600° F; and Mg<sub>4</sub>(F)GeO<sub>6</sub>:Mn, ±10° F at 900° F and ±14° F at 1250° F.

At least four TPs are of particular interest for future work. One of them, Y<sub>2</sub>O<sub>3</sub>:Gd, has strong emission lines that are completely quenched at 1000°C, but some weaker lines are not quenched and therefore might be useful at higher temperatures. Evaluation of the energy-level diagrams of Gd<sub>2</sub>O<sub>3</sub>:Eu indicates that it is also a high-temperature candidate. We

have not yet found a vendor for it, however. The theory indicates that  $\text{Sc}_2\text{O}_3:\text{Eu}$  should be useful at very high temperature because it has a small lattice and a large dopant. We have had a sample grown at the Oak Ridge National Laboratory and are currently testing it. Manganese-doped magnesium fluorogermanate has a large number of thermographic emission lines, some of which appear to be usable at temperatures well in excess of  $1200^\circ\text{C}$ .

Most of our recent effort has gone into studying  $\text{Y}_2\text{O}_3:\text{Eu}$ , which has a 611-nm emission line that is useful to at least  $1200^\circ\text{C}$ . We tested the TP in various forms: powder, hot-pressed capsule, and bonded to surfaces by electron-beam deposition, flame spray, and plasma spray. We found that the "virgin" (prior to temperature cycling) decay time-vs-temperature calibration curves for the various forms showed a disconcerting variation in slope of the semilog plots. Following appropriate "burn-in" by temperature cycling, the curves stabilized, but not necessarily to the same slope for each form of the phosphor. There are also phosphor-binder interactions that are not yet understood.

### Experimental Techniques and Data Analysis

We are methodically evaluating the systematic errors in the calibration equipment, the data-acquisition instruments, and the data-analysis hardware and software. A careful calibration of our laboratory-grade ovens has documented the nature of the thermal gradients.<sup>2</sup> Figure 1 is a three-dimensional plot of temperature as a function of position at a nominal temperature of  $1150^\circ\text{C}$  relative to an NBS-traceable thermocouple. The very substantial variation in temperature ( $70^\circ$  between extremes) shows that one must be very careful, when taking calibration data, to locate samples carefully, especially with respect to the thermocouple. It is also useful to have a rather large thermal mass surrounding samples to serve as a constant-temperature heat sink.

The precision limits of the Tektronix 7854 waveform-processing oscilloscope have been explored.<sup>3</sup> Figure 2 is a plot of the measured decay lifetime as a function of the number of data averagings. Note that there is an optimum number of averagings, at which both the error and the uncertainty are minimized. Above that optimum number, the error in the measured lifetime increases because of truncation errors.

All calibrations so far have used a photomultiplier tube (PMT) as the optical detector. In our quest to maximize the accuracy of the calibration data, we have compared RCA 2020 PMTs with EG&G FOD-100 silicon photodiodes, ITT high-speed vacuum photodiodes, and RCA avalanche photodiodes (APDs). The work with APDs indicates that we may expect better SNR, better background rejection, better linearity, and higher accuracy from them than from PMTs in those situations where their slightly lower gain is not a serious problem. We have also evaluated gating of PMTs as a way of discriminating against backgrounds that steal charge from the tubes. This difficult problem has been looked at extensively by others without finding a fully satisfactory solution. We have devised a new gating technique which looks promising, but it will become academic if APDs fulfill their promise; with them, gating is expected to be unnecessary.

An improvement to the data-acquisition system has reduced the systematic error in the decay-time measurement to 3% at high temperature, compared with the previous 10% or greater. A 150-ns delay after excitation establishes a starting point for the measurement, which then uses the 80% and 30% amplitude points relative to the starting-point amplitude.

A completely different technique is in use for those cases where the characteristic-decay curve deviates substantially from an exponential. This technique calculates the correlation coefficient,  $\rho$ , for a complete waveform at the unknown temperature by comparing it with a stored library of data points at other, known, temperatures. A cubic curve fit to  $1 - \rho$ , as shown in Fig. 3, is plotted vs temperature. The minimum in this curve occurs at the unknown temperature.

The optics used for excitation of TPs and collection of light emission have also been improved. Figure 4 shows an optical assembly we designed and fabricated that efficiently feeds uv light into samples in ovens and detects the fluorescence. Incoming uv is almost entirely reflected by a dichroic mirror into an optical fiber that goes to the sample. The return signal, which includes some uv reflected by the sample, also strikes the dichroic mirror. The background uv is reflected while the visible light passes through. A narrowband optical filter selects the desired wavelength of fluorescence, which passes into the PMT.

The optical fibers that are now being run into ovens directly adjacent to the TP samples replace a less-efficient lens system used previously. Silica fibers begin to sag at about  $1150^\circ\text{C}$ , so we are now using high-purity sapphire rods inside the ovens. Ultimately,

for engine probing, we will encase fibers inside cooled metal probes. Three different versions of these are now either being built or tested for use in different applications.

### Bonding

We are evaluating bonding methods that may be suitable for high-temperature surfaces. We are particularly interested in those techniques that apply TPs directly to surfaces, such as electron-beam, sputtering, flame-spray, and plasma-spray methods, and those wherein TPs are mixed with high-temperature binders.

Several of the binders used are shown in Table II. We will discuss use of one of them in more detail in the next section.

### Direct Methods

- A. Flame spray. Procedures were developed in an attempt to use "carrier" materials (metals or oxides that carry the phosphors with them to the substrate) in the flame-spraying process, with three goals. First, TPs that could not normally be flame-sprayed (because of inappropriate particle sizes or tendency to agglomerate) might now be flame-sprayed. Second, in addition to being used as carriers, metals would better match the coefficient of expansion of the substrate and would have higher thermal conductivity, with obvious benefits. Finally, we could find out if the TP-carrier mixtures would survive the flame-spray temperatures. Table III lists some of the carrier materials and Table IV shows the results of flame spraying with carriers.
- B. Sputtering. We attempted to increase the sputtering rate over that reported previously<sup>1</sup> by constructing a special, water-cooled, larger target. The results were still disappointing. The new target gave a variable thickness (2:1 ratio) of TP over the 6-in x 6-in coating area and the coating was spotty. Sputtering is useful in those applications that require a thin layer of TP but—so far—is not useful for relatively thick coatings.

C. Electron-Beam.  $Y_2O_3:Eu$  was electron-beamed onto selected superalloy bars, IN-100 sheets, and several ceramics. The coatings were smooth, uniform, and adhered well.

D. Plasma-Spray. We are assuming, without doing any actual plasma spraying, that any tests done by flame spraying can be done better by plasma spraying except when the higher operating temperature adversely affects the TPs.

Several samples of inconel sheets and an IN-100 casting on which  $Y_2O_3:Eu$  had been deposited were examined using SEM (scanning electron microscopy) and ESCA (electron spectroscopy for chemical analysis). The results are discussed elsewhere.<sup>4</sup>

### Field Tests

Twelve samples of turbine-blade sections were subjected to a burner-rig test at United Technologies Research Center (UTRC). The bar numbers (our designation), the TPs, and the application method are shown in Table V. The unpassivated bars were subjected to 1170°C at a gas velocity of Mach 0.2–0.4 for two hours. Normally, unpassivated bars are not tested above about 900°C, but no passivated bars were available. Substantial TP loss occurred on all bars. The TP loss was greatest in the flame center where the highest temperature and velocity are expected. However, despite the extreme conditions, all bars had measurable TP remaining outside of the central area, and some had measurable TP in the center. Substrate oxidation and resultant spalling of the TP appears to be the main loss mechanism. Further tests at such temperatures will be restricted to passivated bars.

The experiment design is complete for a spin-pit test at UTRC. This will be the first test of TPs bonded onto an actual turbine disc that is subjected to superimposed centrifugal and heat loads. We will attempt to measure the temperature of the disc during the test. Figure 5 shows the optics layout and Fig. 6 shows the triggering and timing layout. Nine "spots" of TP have been laid out on the disc (Fig. 5) in the same radial position as thin-film thermocouples attached by UTRC personnel. Light at 337-nm from the laser strikes the spots at the several radii on the disc, as selected by the gimbal mirror. The fluorescence-collection optics are housed in a light-tight cylinder. The wavelength

filter selects the desired spectral line after the phosphorescence passes through the aperture (spatial filter), the optical signal is detected by the PMT, and the resultant electrical signal is recorded. The timing (Fig. 6) is set up to synchronize the firing of the laser to the locations of the TP spots. Many details are not shown. For example, a countdown trigger generator selects only every  $n^{\text{th}}$  tachometer pulse from the spin-pit rig, because the laser can only be fired at about 10 pps maximum rate.

The test will include measurements at 300, 600, 900, and 1250°F. The three TPs discussed in the previous section will cover the test temperature range.

None of the direct phosphor-application methods is suitable for this test. For example, none of the three TPs can be flame-sprayed. Electron-beam deposition was not used because  $\text{La}_2\text{O}_2\text{S}$  cannot be hot-pressed and the other two TPs have never been hot-pressed, a requirement for the electron-beam target. Of the binders tested, CRC-SBE was chosen because it reduces oxidation of the substrate, can be applied in a thin coat, withstood g-load tests at 1000°F, and passed a simple durability test.

## REFERENCES

<sup>1</sup>B. W. Noel, *et al.*, "Proposed Laser-Induced Fluorescence Method for Remote Thermometry in Turbine Engines," *J. Propulsion and Power* 2, 565 (1986).

<sup>2</sup>W. N. Lutz, *et al.*, "An Oven Calibration System with Automated Data Acquisition and NBS Traceability," University of Virginia report UVA/532666/NEEP86/101C (June 1986).

<sup>3</sup>L. J. Dowell, *et al.*, "Precision Limits of Waveform Recovery and Analysis in a Signal Processing Oscilloscope," *Rev. Sci. Instrum.*, to be published in July, 1987.

<sup>4</sup>D. L. Beshears, M. J. Bridges, and L. A. Harris, "Evaluation of Commercially Available Coating Techniques for Nickel-Based Alloys," Martin Marietta report K/TS-11,801 (April 1986).

## FIGURE CAPTIONS

1. Plot of the temperature vs position in a laboratory oven.

2. Measured decay lifetime vs number of data averagings for a Tektronix 7854 oscilloscope.
3. Curve fit to  $1 - \rho$  as a function of temperature.
4. Optical assembly for feeding uv light into thermographic-phosphor samples in ovens and for extracting and separating the desired luminescence signal.
5. Optics layout for the spin-pit test
6. Triggering and timing layout for the spin-pit test



*Table I of TP*  
**Summary of Measurements on Phosphor Powders**

Phosphor	Vender			Color to Eye	Range Measured (°C)	Emission Spectrum	Excitation Spectrum
	GTE	USR	Other				
La <sub>2</sub> O <sub>2</sub> S:Eu		x		yellow	-200 to +200	yes	yes
Y <sub>2</sub> O <sub>2</sub> S:Eu	x	x	x	red	30 to 300	yes	yes
La <sub>2</sub> O <sub>2</sub> S:Tb	x	x		green		yes	
Gd <sub>2</sub> O <sub>2</sub> S:Tb	x	x		green		yes	
Y <sub>2</sub> O <sub>2</sub> S:Tb	x			blue to white	100 to 310	yes	yes
Y <sub>2</sub> O <sub>2</sub> S:Tb	x			green	260 to 540	yes	yes
Y <sub>2</sub> O <sub>2</sub> S:Pr		x		white		yes	yes
YVO <sub>4</sub> :Eu	x			red	350 to 500	yes	yes
YVO <sub>4</sub> :Dy	x			yellow	280 to 370	yes	yes
Y <sub>2</sub> O <sub>3</sub> :Eu	x	x		red	600 to 1200	yes	yes
Y <sub>2</sub> O <sub>3</sub> :Gd	x			blue		yes	yes
Sc <sub>2</sub> O <sub>3</sub> :Eu			x	red	400 to 1200	yes	yes
Mg <sub>4</sub> (F)GeO <sub>6</sub> :Mn	x			435 to 730	yes	yes	
Y <sub>3</sub> Al <sub>5</sub> O <sub>12</sub> :Tb		x		750 to 1100	yes	yes	
Ba <sub>3</sub> (PO <sub>4</sub> ) <sub>2</sub> :Eu	x			blue		yes	yes
BaClF:Eu	x			red		yes	
BaClF:Sm			x	red	(bad sample)		

**Table II**  
**Summary of Measurements on Bonded Phosphors**

Phosphor Binder Substrate	Measured Temperature Range (°C)	Decay Times (μs)	Temperature Cycling	Precision Value	Excitation Spectra at T <sub>r</sub>	Emission Spectra at T <sub>r</sub>	Emission Spectra at >T <sub>r</sub>	Emission Line (nm)	Comments
La <sub>2</sub> O <sub>3</sub> S:Eu CRC-SBE (note 1) IN-100	100-200	120-20	yes; loses sensitivity	yes (note 6)	yes	yes before and after cycle	no	537	saturation observed
La <sub>2</sub> O <sub>3</sub> S:Eu P-1 (note 2) IN-100	100-200	12-20	yes; shifts calibration	no	no	yes before and after cycle	no	537	
Y <sub>2</sub> O <sub>3</sub> S:Eu (note 3) IN-100	100-200	120-20	yes; loses sensitivity	no	no	yes before and after cycle	no	537	more sensitivity loss with cycling than with CRC-SBE binder
Y <sub>2</sub> O <sub>3</sub> S:Tb flame sprayed IN-100	260-540	450-2	yes; 4 cycles to 650° C	no	no	yes before and after cycle	no	544	calibration shifted ±25° C with cycling
YVO <sub>4</sub> :Dy CRC-SBE IN-100	280-370	140-20	yes; 2 cycles to 650° C	yes (note 6)	no	yes before and after cycling	no	574	no change with cycling; saturation observed
YVO <sub>4</sub> :Eu C904 (note 4) IN-100	425-700	290-4	yes; 1 cycle to 700° C	no	yes	yes	no	617	good alternative to Mg <sub>4</sub> (F)GeO <sub>6</sub> :Mn
Mg <sub>4</sub> (F)GeO <sub>6</sub> :Mn Al	10-480	3000-340	no	no	no	yes	yes	664 — 637	ratio of two lines as a function of temperature
Mg <sub>4</sub> (F)GeO <sub>6</sub> :Mn CRC-SBE IN-100	425-760	200-0.24	yes; 2 cycles to 760° C	yes (note 6)	yes	yes	no	660	loses quantum efficiency with cycling (note 7)
Y <sub>2</sub> O <sub>3</sub> :Eu flame-sprayed IN-100	590-700	300-100	yes; 6 cycles to 730° C	no	yes	yes	no	611	
Y <sub>2</sub> O <sub>3</sub> :Eu (note 5)	560-850	500-4	no	no	no	no	no	611	study compares calibration curves for different deposition methods
Y <sub>2</sub> O <sub>3</sub> :Eu hot-pressed pellet	600-1035	300-0.4	yes; 2 cycles to 1030° C	yes	yes	yes	no	611	

**Notes.**

1. CRC-SBE is a water-based ceramic refractory paint made by Ceramic Refractory Corp.
2. P-1 is a powder or paste form of Insa-Lute Adhesive Cement #1 made by Sauerisen Cements Co.
3. SC is a cellulosic-based binder made by ZYP Coatings, Inc.
4. C904 is an ultrahigh-temperature zirconia-based pigment vehicle made by Cotronics Corp.
5. This phosphor was compared in three different forms: electron-beam deposited, plasma-sprayed, and sputtered.
6. Precision values of these phosphors were established in order to use the phosphors in the spin-pit test described below.
7. This phosphor is used in a commercially available dc thermometry instrument in the temperature range from -100 to 400° C. However, decay times in this region are too long to be usable in rapidly rotating objects.

**TABLE III. Carrier Materials**

<b>Material</b>	<b>Components</b>	<b>Comments</b>
M461	Ni, Cr, Al, Co, Y	Self-bonding
M15E	Ni, Cr, Fe, Si, B, C	Self-fluxing
PWA 1368	Ni, CO, Cr, Al, Hf, Y	Passivation Layer
M201	ZrO <sub>2</sub> + CaCO <sub>3</sub>	To be used with a bond coat
M202	ZrO <sub>2</sub> + Y <sub>2</sub> O <sub>3</sub>	To be used with a bond coat
M31C	Ni, WC, Cr, B, Si	Self-fluxing

*Flame Spray Cannon - Phosphate Test*

TABLE(V. Burner-Rig-Test Bars

Mix	Mix Ratio	Comments
$Y_2O_3:Eu + M15E$	1:2	Fluor in pits - on grinding down, fluor greatly reduced
$Y_2O_3:Eu + M461$	1:1	Fluor in pits - in grinding down, fluor greatly reduced
$Y_2O_3:Eu + PWA 1368$	1:1	No visible fluor
$Y_2O_3:Eu + M202$	1:2	Fluor
$Y_2O_3:Eu + M201$	1:2	Fluor - somewhat spotted
$Mg_4(F)GeO_6:Mn + M202$	1:2	Spotted Fluor
$Y_2O_3:Eu + M31C$	1:2	Fluor in pits - on grinding down, fluor greatly reduced

**TABLE V. Burner-Rig-Test Bars**

<b>Bar #</b>	<b>Phosphor</b>	<b>Application Method</b>
FJ6	$Y_2O_3:Eu/Y_2O_2S:Tb$	Flame spray
FJ4	$Y_2O_3S:Tb/ZrO_2$	Flame spray
FJ3	$Y_2O_3S:Tb/ZrO_2$	Flame spray
E-3J5	$Y_2O_3:Eu$	E Beam
P-3J3	$Y_2O_3:Eu$	Plasma
FJ2	$Y_2O_3:Eu/ZrC_2$	Flame spray
FJ1	$Y_2O_3:Eu/ZrO_2$	Flame spray
E3J4	$Y_2O_3:Eu$	E Beam
FJ5	$Y_2O_3S:Tb/Y_2O_3:Eu$	Flame spray
E3J3	$Y_2O_3:Eu$	E Beam
P2J4	$Y_2O_3:Eu$	Plasma spray
SP-3-1	$Y_2O_3:Eu$	Sputter

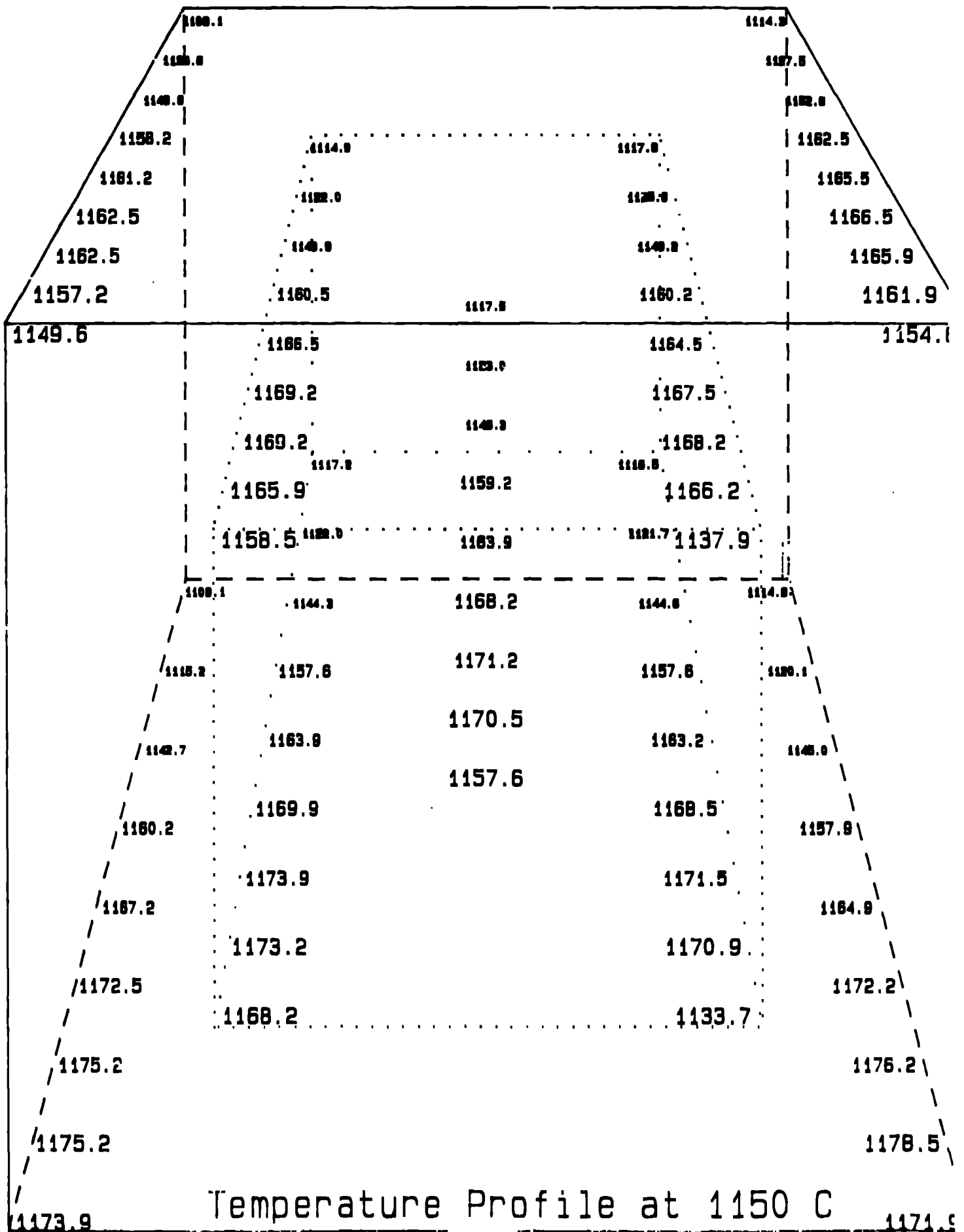

FIG 1

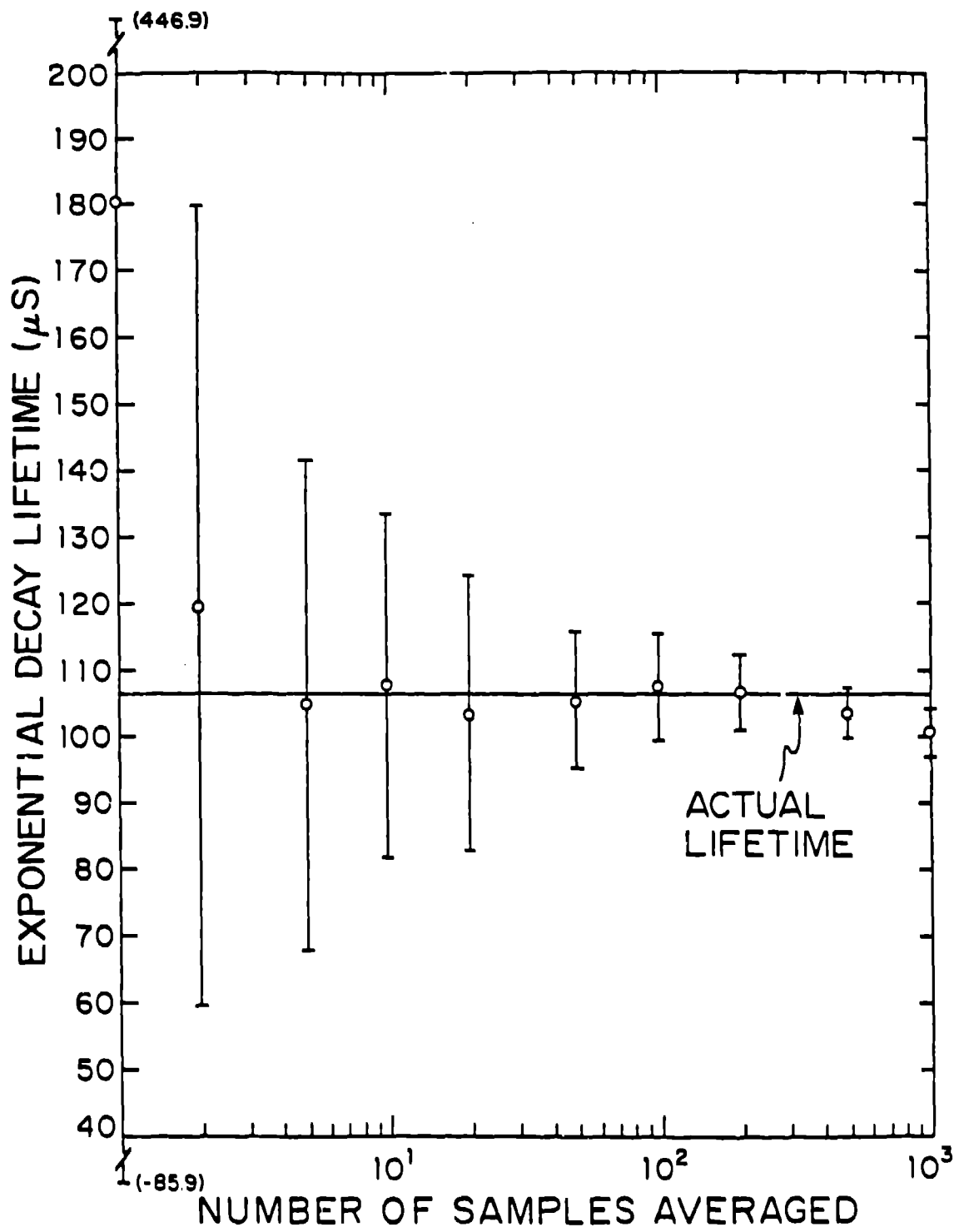
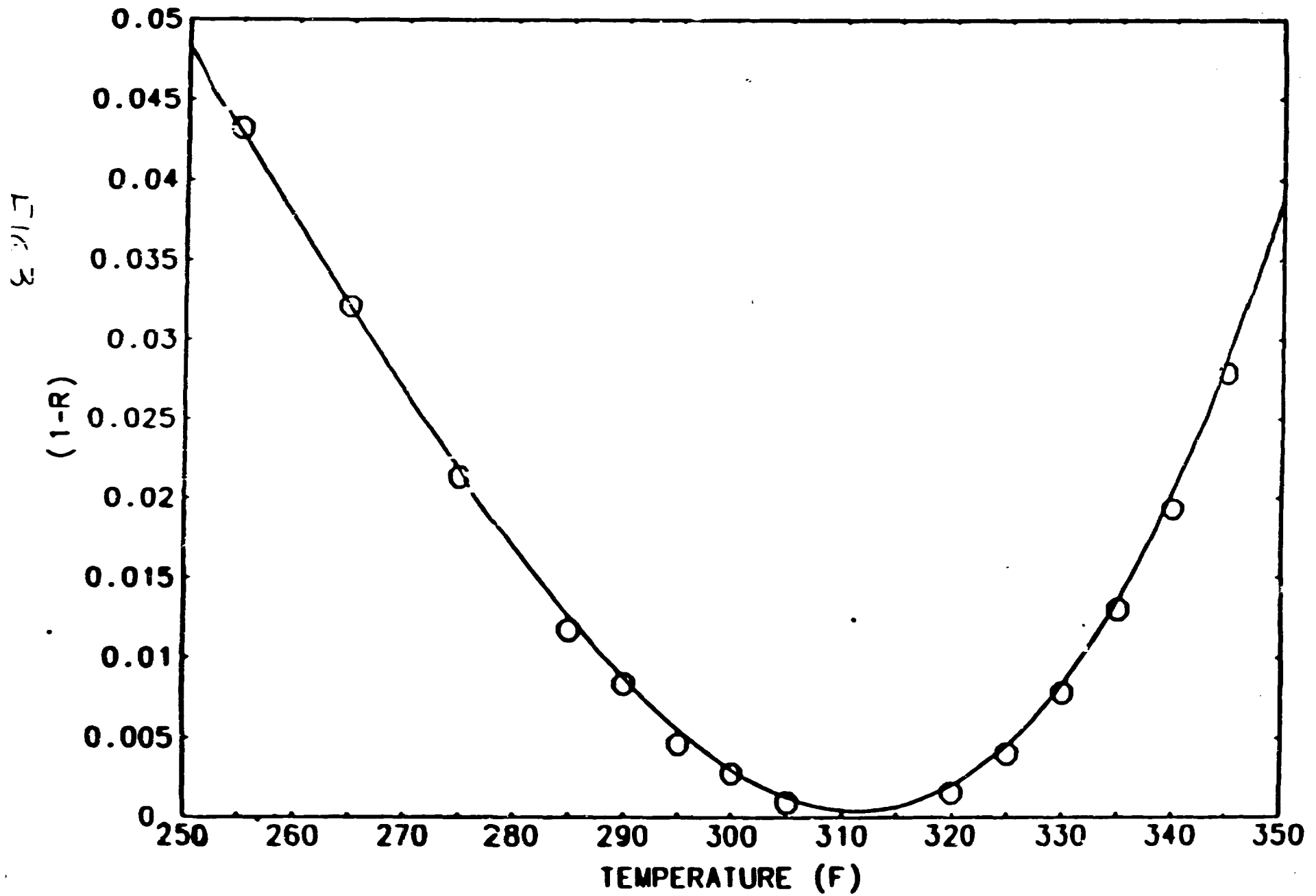

FIG 2

1-Correlation Coef. vs. Temperature for  $\text{La}_2\text{O}_3:\text{Eu}$ . Measurement at  $310^\circ\text{F}$  correlated against library extending from  $250$  to  $350^\circ\text{F}$ .





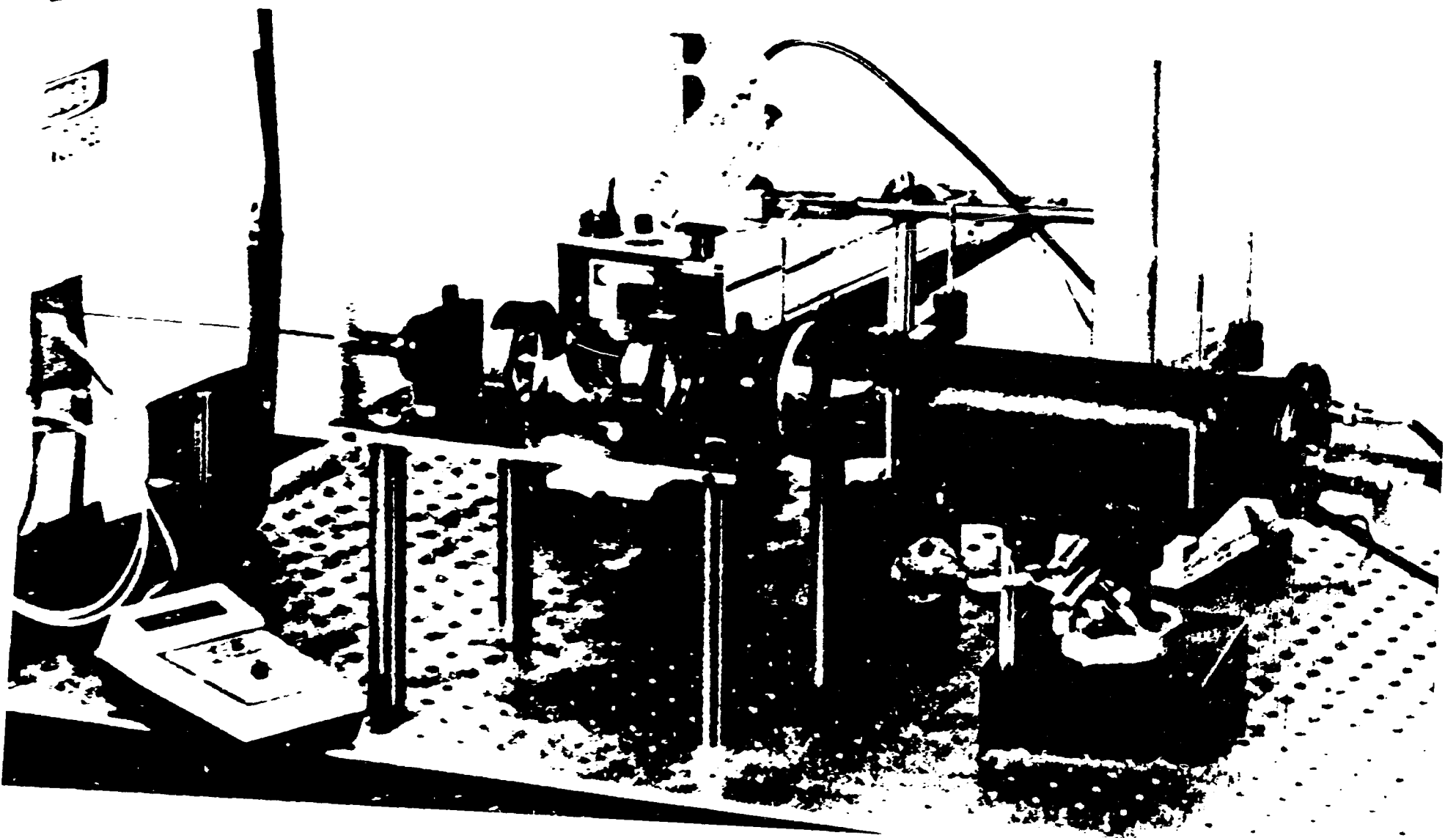
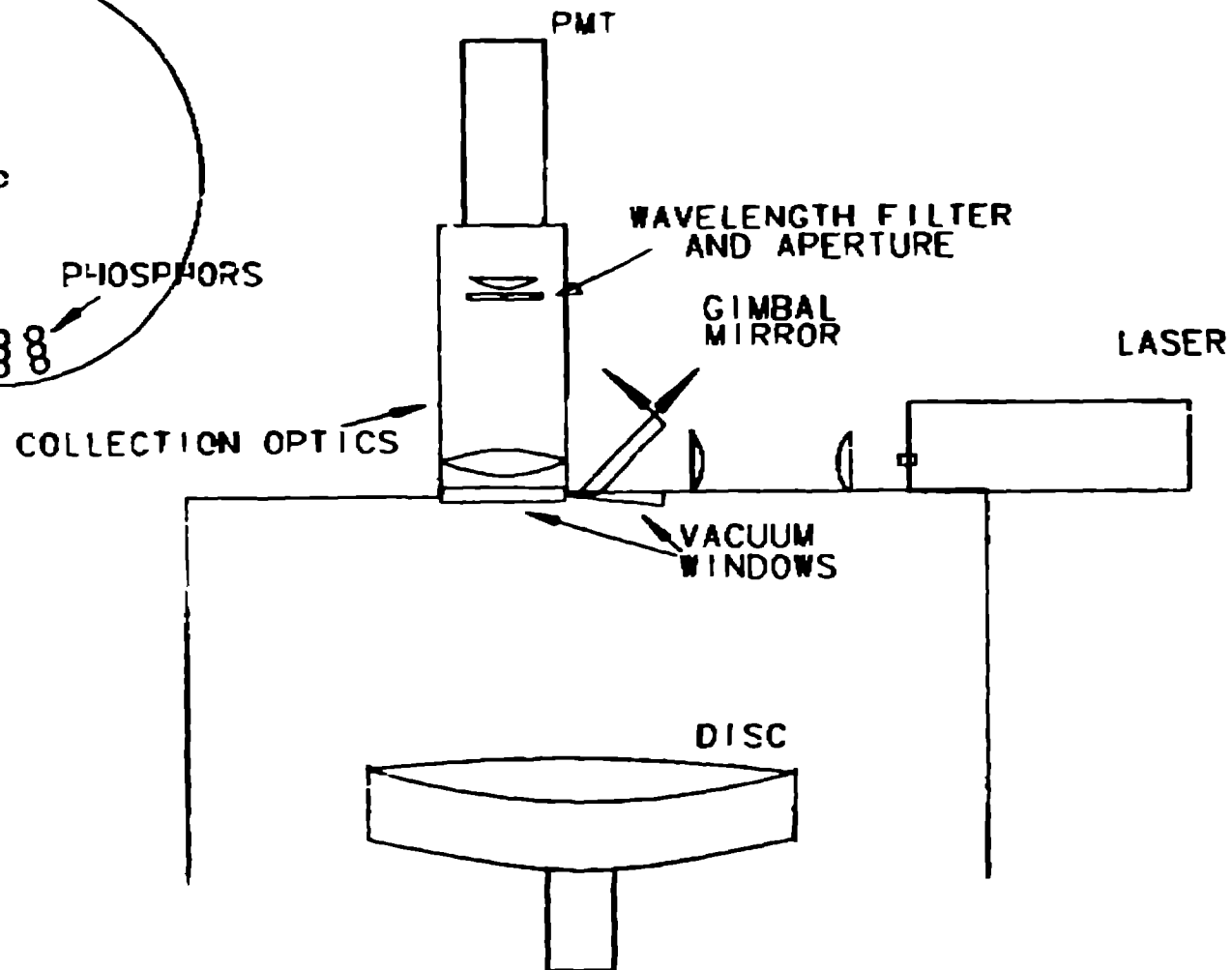
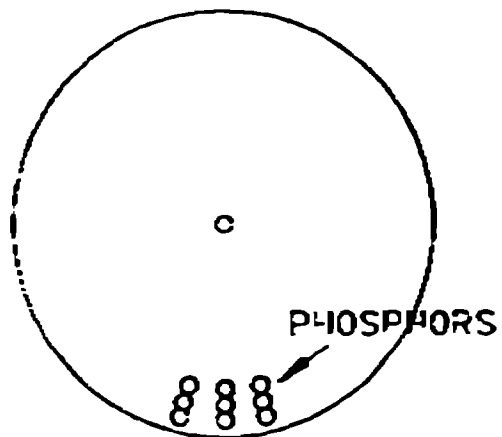
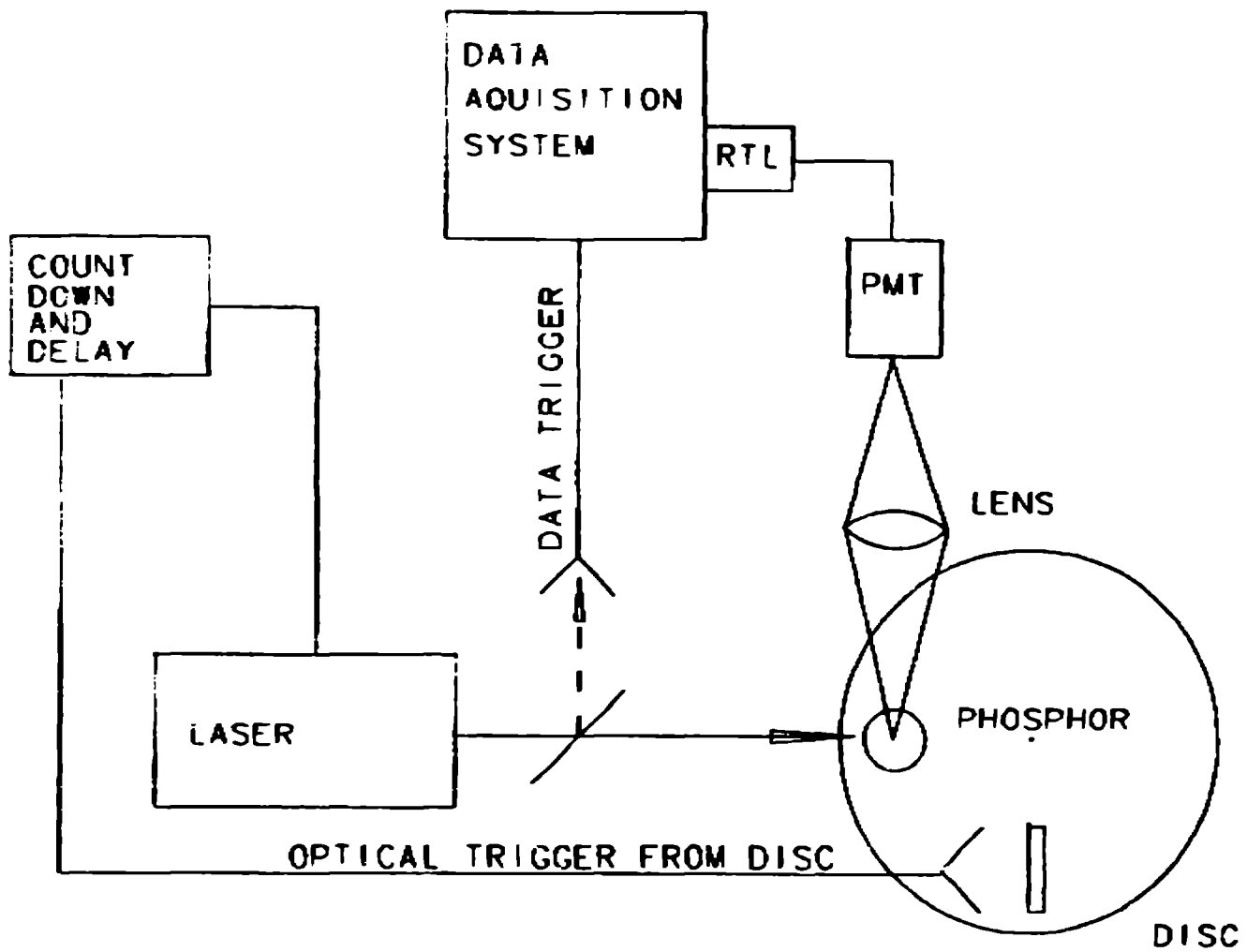

FIG. 4



THERMOGRAPHIC PHOSPHOR MEASUREMENT  
UNITED TECHNOLOGIES SPIN-PIT

FIG 6



TRIGGER LAYOUT FOR UTC PHOSPHOR EXPERIMENT