

REPORT No. 615

COLUMN STRENGTH OF TUBES ELASTICALLY RESTRAINED AGAINST ROTATION AT THE ENDS

By WILLIAM R. OSGOOD

SUMMARY

A study was made of the effects of known end restraint on commercially available round and streamline tubing of chromium-molybdenum steel, duralumin, stainless steel, and heat-treated chromium-molybdenum steel; and a more accurate method than any previously available, but still a practical method, was developed for designing compression members in riveted or welded structures, particularly aircraft.

Two hundred specimens were tested as short, medium-length, and long columns with freely supported ends or elastically restrained ends. The test specimens were centered under load on knife edges held in carriers, and the free lengths were computed by a rational method not heretofore used. Tensile and compressive tests were made on each piece of original tubing from which column specimens were cut. The column data were reduced with the aid of these tests, and formulas were constructed to represent the column strengths in terms of specified tensile yield strengths of the four materials used.

It was found possible to extend work done by Bleich on the design of elastically restrained compression members in bridges and to present a method that should be suitable for designing such members in aircraft. The design is facilitated greatly by the use of tables and a nomographic chart, both included in this paper. A numerical example is also given.

INTRODUCTION

Compression members, particularly in riveted or welded structures like bridges and fuselages of airplanes are columns elastically restrained against rotation at the ends, and the strengths of such members lie between the strengths they would have if perfectly free to rotate at the ends, on the one hand, and if perfectly fixed at the ends, on the other hand. The interest of the Bureau of Aeronautics, Navy Department, and of the National Advisory Committee for Aeronautics in the strengths of compression members of the kind mentioned led to the transfer of funds to the National Bureau of Standards in July 1928 and thereafter for an investigation of the subject.

The column strengths of round and of streamline tubular specimens of chromium-molybdenum steel, of duralumin, of stainless steel, and of heat-treated

chromium-molybdenum steel have been studied. The diameters of the round tubes ranged from 1 inch to 2 inches and the basic diameters of the streamline tubes from $1\frac{1}{8}$ to $2\frac{1}{2}$ inches. The thicknesses of both sets of tubes ranged from 0.035 to 0.083 inch. Tests were made which included comprehensive tensile and compressive tests of the material used, 186 tests of specimens as initially centrally loaded columns with freely supported ends and with various known equal elastic restraints at both ends, and 14 such tests with one end freely supported and the other end restrained elastically in a known manner. In this paper these tests are described, and the column tests, further, are interpreted in the light of the double-modulus theory of column action and are related to the mechanical properties of the materials of the tubes. The question of designing elastically restrained compression members is also considered.

The author is particularly indebted to Dr. L. B. Tuckerman for advice and suggestions during the progress of the investigation, and to several other members of the Engineering Mechanics Section of the National Bureau of Standards for ideas and helpful suggestions in smoothing difficulties encountered from time to time in the laboratory work. It is a pleasure to acknowledge the assistance received in this way. Mr. E. E. Lundquist of the National Advisory Committee for Aeronautics was much interested in the problem of designing compression members elastically restrained against rotation at the ends and offered valuable criticism of the section on the design of such members. His comments resulted in a great improvement in this section.

The author wishes also to express appreciation for the tubing donated by the Aluminum Co. of America, by the Summerill Tubing Co., and by the Navy Department, and for the heat treatment of the heat-treated chromium-molybdenum-steel tubing by Metallurgical Laboratories, Inc.

A considerable part of this paper was submitted as a thesis in partial fulfillment of the requirements for the degree of Doctor of Philosophy in engineering in the graduate school of the University of Illinois, 1933. Acknowledgment is here made for permission granted by the graduate school of the University of Illinois to use this material.

MATERIAL AND MATERIAL TESTS

THE MATERIAL AND ITS PREPARATION FOR TEST

The round chromium-molybdenum-steel tubing had been bought under U. S. Army Specification No. 57-180-2A now covered by U. S. Army Specification No. 57-180-2C, the equivalent of Navy Department Specification 44T18c, Feb. 1, 1937: Tubing, Steel (Chrome-molybdenum) Round, Seamless (Aircraft Use). In the latter specification:

The specified minimum yield strength was raised from 60,000 to 75,000 lb. per sq. in., for the sizes of tubing that were used, and a more precise method of determining the yield strength was specified.

The specified minimum elongation in 2 in. was raised from 10 to 12 percent for sizes 0.036 to 0.188 in. thick.

The round duralumin tubing, donated by the Aluminum Co. of America, Pittsburgh, Pa., was supplied to conform with Navy Department Specification 44A2, now covered by Navy Department Specification 44T21b, May 1, 1937: Tubing, Aluminum-alloy (Aluminum-copper-magnesium-manganese), Round, Seamless, Condition "T", heat treated. In the latter specification:

The specified minimum yield strength was raised from 30,000 to 40,000 lb. per sq. in., and a more precise method of determining the yield strength was specified.

The specified percentage elongation in 2 in. was lowered by 2 for all sizes covered in the earlier specification ($\frac{1}{4}$ to $\frac{3}{8}$ in., inclusive, nominal outside diameter).

The round stainless-steel tubing was bought under Proposed Navy Department Specification M-55b, temper C tubing, now covered by Bureau of Aeronautics Specification 44T27 (INT) 22 April 1937 for Tubing, Steel, Corrosion-resisting (18 percent Chromium and 8 percent Nickel) Seamless, Drawn, Round, Structural $\frac{1}{4}$ H-Cold-Drawn, Pickled. In the latter specification:

The specified yield strength was lowered from 150,000 lb. per sq. in. to a minimum of 135,000 lb. per sq. in. and at the same time the method of determining the yield strength was changed to conform in effect to the definition given in Navy Department Specification 44T27, "The yield strength is the load per square inch of original cross section at which the material exhibits an extension under load of 0.002 inch per inch in excess of that which would be computed from Young's modulus of elasticity of 25,000,000 pounds per square inch and the usual formula: Unit stress = Young's modulus \times unit deformation."

The specified elongation in 2 in. was lowered from 8 percent for a full-tube specimen to a minimum of 5 percent for material over 0.02 in. thick and not over 0.049 in. thick and to a minimum of 6 percent for material over 0.049 in. thick.

Flattening requirements were added.

All the chromium-molybdenum-steel tubing that was heat treated was donated by the Summerill Tubing Co., Bridgeport, Pa., and was heat treated free of charge by Metallurgical Laboratories, Inc., Philadelphia, Pa., to a requested tensile strength of 175,000 lb. per sq. in., no specification applying.

The streamline chromium-molybdenum-steel tubing donated by the Summerill Tubing Co., Bridgeport, Pa., was supplied to conform with Navy Department Specification 44T17a, now covered by Navy Depart-

ment Specification 44T17b, Dec. 1, 1936: Tubing, Steel (Chrome Molybdenum), Structural, Streamline Cross Section, Seamless (Aircraft Use). In the latter specification:

The specified minimum yield strength was raised 10,000 lb. per sq. in., but the method of determining the yield strength was changed so that most material passing the old specification would probably also pass the new one.

The streamline duralumin tubing, donated by the Aluminum Co. of America, Pittsburgh, Pa., was supplied to conform with Navy Department Specification 44T22, now covered by Navy Department Specification 44T22a, Feb. 1, 1937: Tubing, Aluminum-alloy (Aluminum-copper-magnesium-manganese), Streamline (Aircraft Use). In the latter specification:

Maximum chemical contents of iron, silicon, chromium, and other elements (including zinc) were specified.

The specified minimum yield strength was raised from 30,000 to 32,000 lb. per sq. in.

The streamline stainless-steel tubing was supplied by the Navy Department, which bought it under Navy Department Tentative Specification M-55C, either Grade 1 or 2 tubing with physical properties specified for temper "B" and with cross-sectional dimensions to conform to those shown in table 2 of Navy Department Specification 44T22, now covered by Navy Department Specification 49T11, May 1, 1937: Tubing, Steel, Corrosion-Resisting (18 percent Chromium and 8 percent Nickel), Seamless-Drawn, Streamline-Cross-Section (Aircraft Use), $\frac{1}{2}$ H-Cold-drawn, Pickled. In the latter specification:

The specified yield strength was lowered from 125,000 to 110,000 lb. per sq. in., and the method of determining the yield strength was changed to conform in effect to the definition noted under the description of the round stainless-steel tubing.

This specified percentage elongation in 2 in. was lowered from 15 for a strip specimen to 13 for material over 0.049 in. thick and to 8 for material not over 0.049 in. thick.

Since for the purpose of the present investigation the latest specifications are, with the exceptions noted, essentially the same as those under which the tubing was supplied, reference to specifications hereinafter will be confined to the latest specifications.

The nominal dimensions of the tubes used are given in table I. One tensile specimen and one compressive specimen were taken from each tube, usually from opposite ends, most of the remainder of the tube being available as column specimens. All these specimens were weighed, their lengths and the outside diameters of the round specimens were measured, and representative determinations of density were made by the Division of Weights and Measures of the Bureau. The cross-sectional area of each specimen was computed from the weight, the length, and the density. The least radii of gyration of the cross-sectional areas of the round specimens were determined from the actual dimensions and of the streamline specimens by subjecting representative specimens to pure bending,

measuring deflections, and computing the radii of gyration from the results so obtained and the values of the moduli of elasticity found for the compressive specimens.

The initial deflections of all the column specimens except a few short ones were measured.

TENSILE AND COMPRESSIVE TESTS

The tensile tests were made in a 100,000-lb. (50,000-kg) Amsler machine having scale ranges from 0 to 10,000, 20,000, 50,000 and 100,000 lb. Most of the compressive tests were made in a 50,000-lb. compound-lever machine, having scale ranges from 0 to 5,000 and 50,000 lb., in which the movable head could be maintained very rigid. Most of the compressive specimens were tested with the lower end against a flat block and the upper end against a hemispherical bearing.

Strains were measured with a Ewing extensometer, when possible, on a 2-inch gage length; otherwise Tuckerman strain gages were used for determinations of moduli of elasticity, and Huggenberger extensometers for determinations of yield strengths. The moduli of elasticity were obtained from stress-strain data by means of difference curves (reference 1) drawn for each of the tensile and compressive specimens. The stress-strain data for determining the modulus of elasticity were usually taken after the specimen had been strained to about 0.002 and the strain released. This procedure "ironed out" some of the initial stresses in the material and in many cases, particularly that of the stainless steel, made the determination of the modulus of elasticity much more definite than it would have been if determined from readings taken during the first loading. In these cases, owing to the immediate curvature of the stress-strain diagram at low stresses, the modulus of elasticity would have had to have been determined as the tangent modulus at zero stress, a very unsatisfactory determination.

In most cases the tensile yield strengths were obtained from stress-strain diagrams, according to the definitions in the latest Navy Department specifications applying to the type of tubing tested.¹ The compressive yield strength was obtained from a stress-strain diagram as the stress corresponding to the intersection with the stress-strain curve of a line drawn through the origin with a slope βE , where $0 < \beta < 1$ and E is the modulus of elasticity. This method is discussed later. The values of β used were: for the chromium-molybdenum steel, 5/9; for duralumin, 2/3; for stainless steel, 5/8; and for heat-treated chromium-molybdenum steel, 5/7.

Typical stress-strain diagrams are shown in figures 1, 2, 3, and 4.

¹ In the case of the heat-treated chromium-molybdenum-steel the tensile yield strength was taken as the stress at the intersection with the stress-strain curve of a line with a slope equal to that of the modulus line and at a strain 0.002 from it.

COLUMN TESTS

The primary series of column tests were tests with freely supported ends. As can readily be shown theoretically, the buckling strength of an ideal column having known elastic restraints at the ends is the same as the buckling strength of a column with freely supported ends having a length equal to the distance between the successive points of inflection of the center line of the column with restrained ends. Local, crinkling failures are not considered here. The length of the equivalent freely supported column is called the "free length" of the column. Although the double-modulus theory of column action (reference 2)² furnishes a method of determining the free length of an ideal column, as will be shown later, the imperfections of real columns made an experimental check seem advisable, and at Dr. L. B. Tuckerman's suggestion a considerable number of specimens were tested with known elastic restraints. The restrained ends also simulate more nearly the practical condition under which actual columns are used.

APPARATUS FOR PROCURING RESTRAINTS AT ENDS

The diagrammatic sketch (fig. 5), shows the lower fixture used for procuring an elastic restraint at the lower end of a column. Except for unimportant details, the upper fixture is the same as the lower. Each fixture consists essentially of a carrier with a knife edge which bears on a seat on a stationary support clamped to the weighing table of the testing machine. Means are provided for holding the end of the test specimen in position on the carrier and moving it horizontally under low loads in a direction perpendicular to the knife edge. Rotation of the carrier about the knife edge is restrained by the helical springs shown. The degree of restraint may be varied by changing the active lengths of the springs, provision for which is furnished. By means of a dial gage, not shown in the figure, it is possible to measure the rotation of the carrier about the knife edge. Wing nuts on the ends of the rods through the springs make it possible to compress the latter so that rotation of the carrier will not cause one spring to go out of action (the springs cannot be used in tension).

PROCEDURE FOR MAKING A TEST

The same vertical testing machine was used for the column tests as for most of the compressive tests previously mentioned. Before a series of columns with elastically restrained ends was tested, it was necessary to adjust the active lengths of the springs to procure the degree of restraint against rotation desired and then, after compressing the springs by means of the wing nuts, to determine the restraint accurately. This determination was made by hanging a series of known

² As indicated in this paper, the theory was developed by contributions of several men. It cannot justly be named after any one of them, nor even two, without denying credit due elsewhere. Dr. L. B. Tuckerman suggested the name "double-modulus theory."

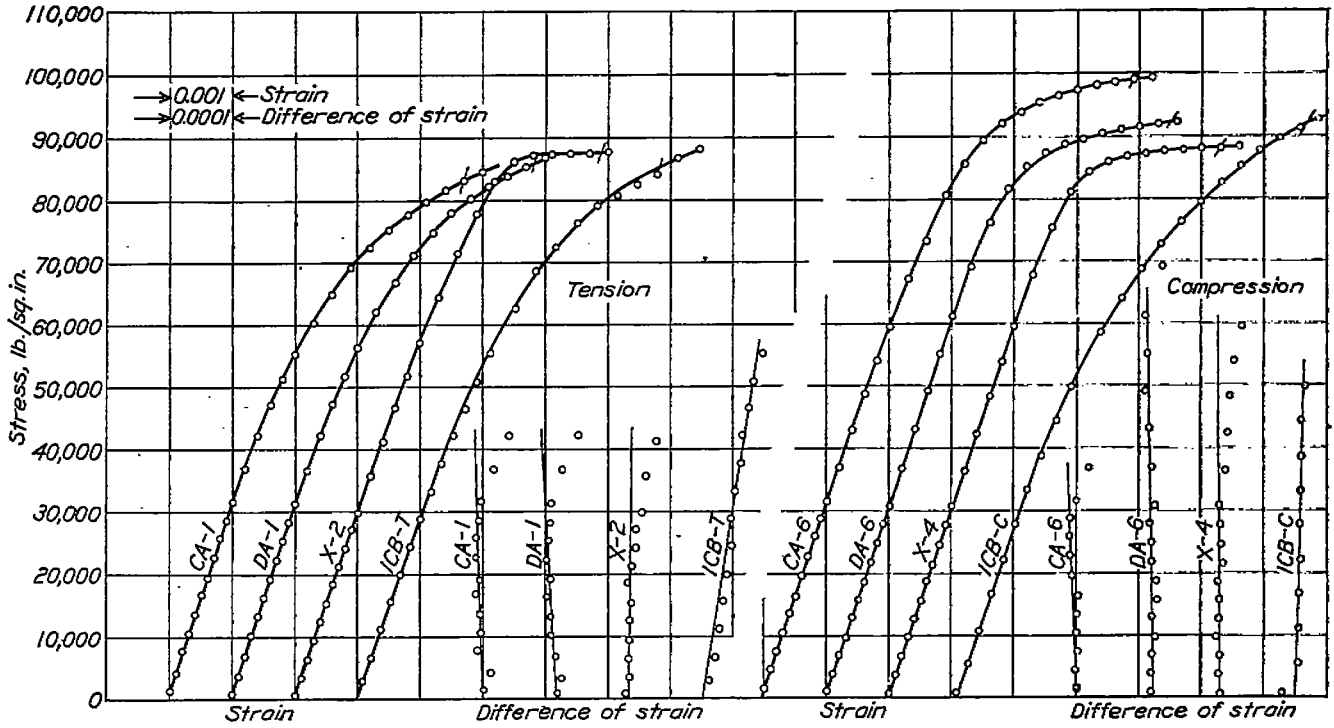

FIGURE 1.—Typical stress-strain diagrams of chromium-molybdenum steel.

$$\text{Difference of strain} = \text{Strain} - \frac{\text{Stress}}{\text{Trial modulus}}$$

Trial modulus = 30,000,000 lb. per sq. in.

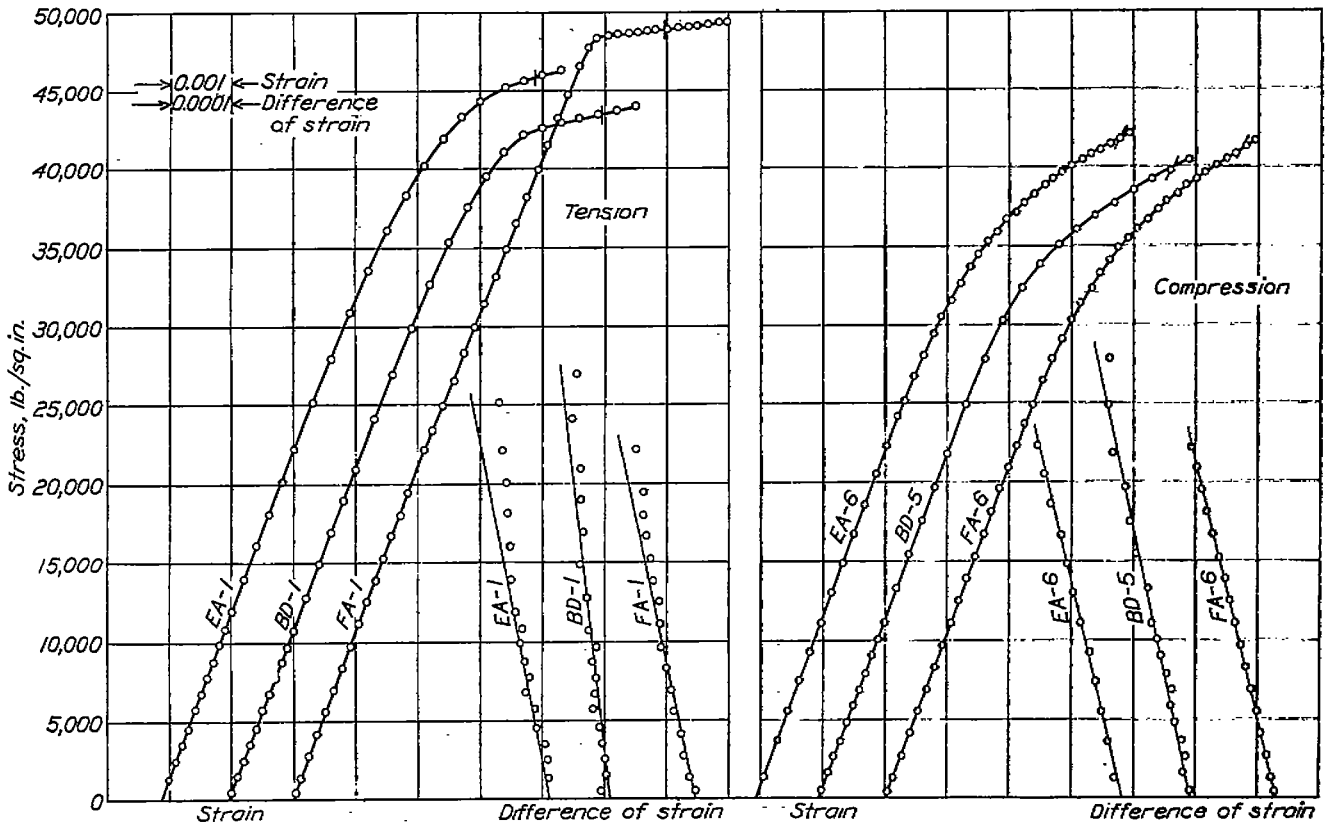

FIGURE 2.—Typical stress-strain diagrams of duralumin.

$$\text{Difference of strain} = \text{Strain} - \frac{\text{Stress}}{\text{Trial modulus}}$$

Trial modulus = 10,000,000 lb. per sq. in.

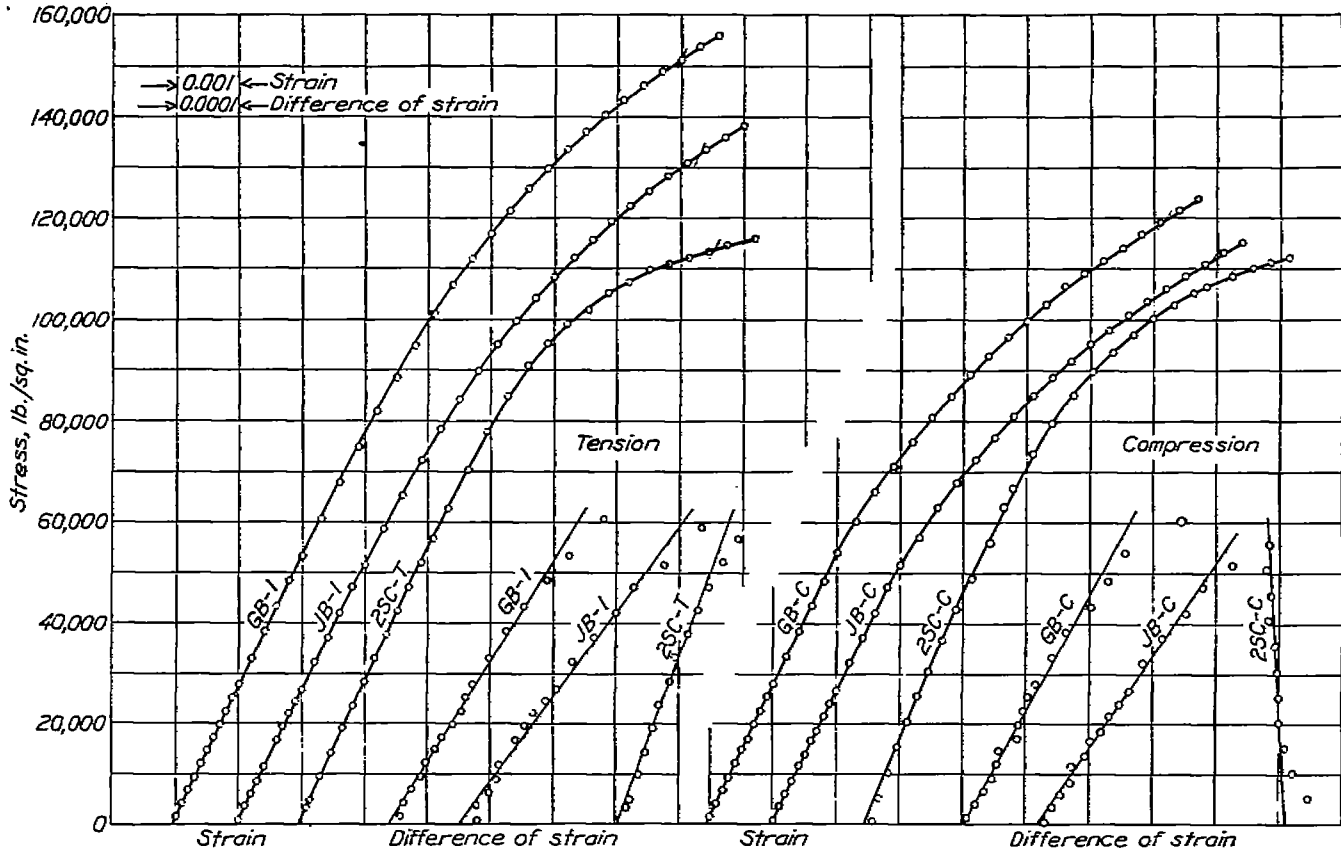

FIGURE 3.—Typical stress-strain diagrams of stainless steel.

$$\text{Difference of strain} = \text{Strain} - \frac{\text{Stress}}{\text{Trial modulus}}$$

Trial modulus = 30,000,000 lb. per sq. in.

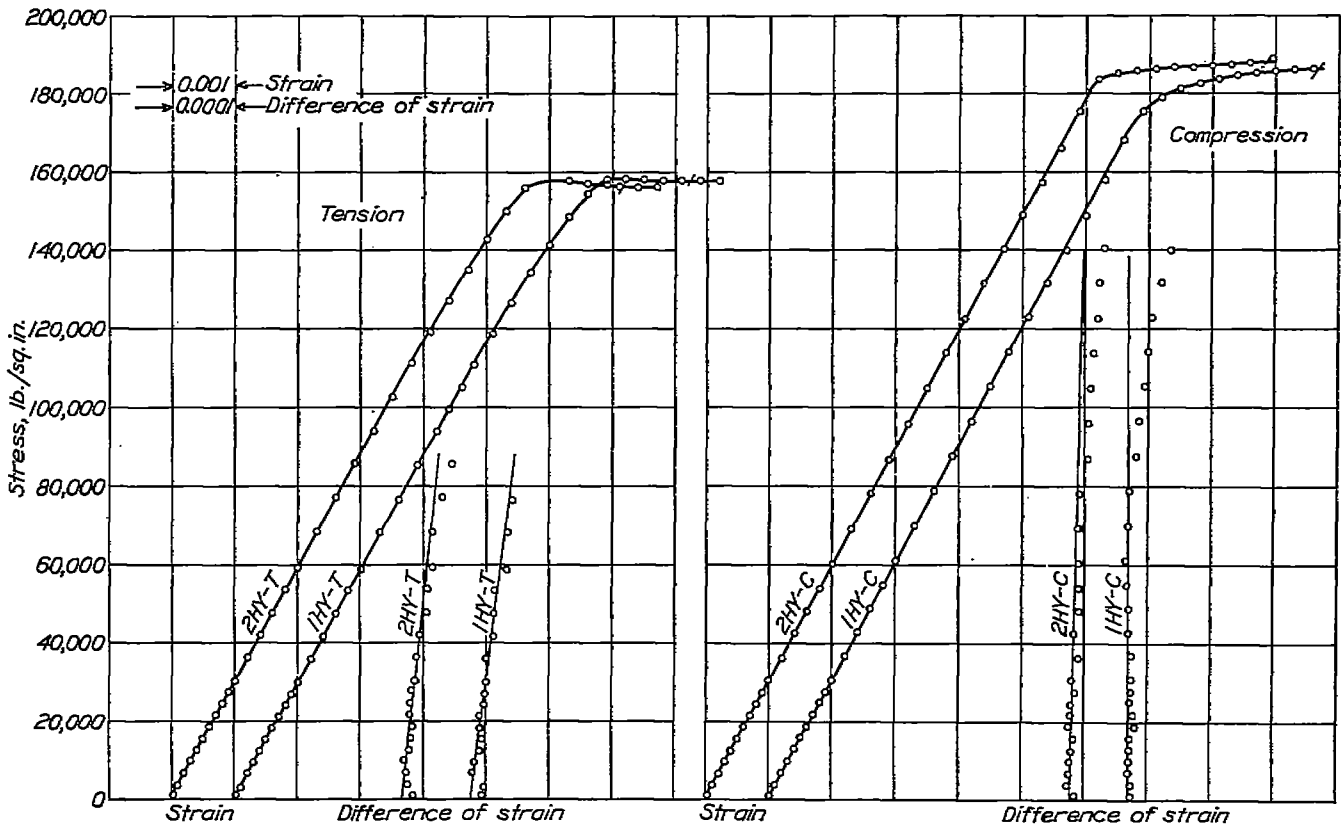

FIGURE 4.—Typical stress-strain diagrams of heat-treated chromium-molybdenum steel.

$$\text{Difference of strain} = \text{Strain} - \frac{\text{Stress}}{\text{Trial modulus}}$$

Trial modulus = 30,000,000 lb. per sq. in.

weights on one of the hangers at the ends of the carrier (fig. 5), thus causing the carrier to rotate about the knife edge, and noting the corresponding readings of the dial gage indicating rotation (not shown in the figure). From data obtained in this way the moment on the carrier could be plotted against the rotation of the carrier, and the moment per unit angular rotation, which will be called the "restraint", m , could be determined as the slope of the resulting diagram. The restraints used are given in table I.

The procedure proper, for making a column test consisted in placing the specimen between the upper and lower carriers, centering under load³ with the springs out of action, and then bringing the springs

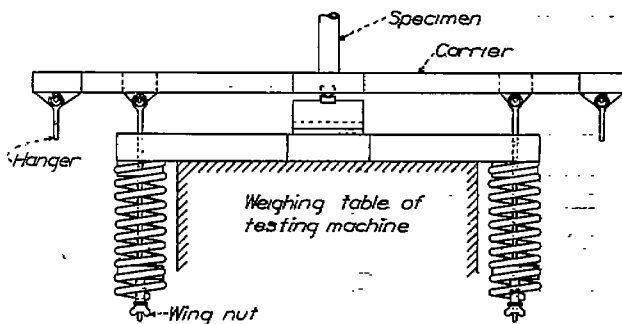

FIGURE 5.—Diagrammatic sketch showing apparatus for procuring elastic restraint at end of column.

into action if the test was to be made with restrained ends, and loading to failure.

RESULTS

DETERMINATION OF THE FREE LENGTH

The results of the column tests were plotted in terms of the ratio of slenderness, based on the free length, and the average stress at failure, and also in terms of nondimensional variables that took into account the properties of the material. The first question that presented itself in preparing such a graphical representation was the determination of the free length. The rigid carriers at the ends of the columns complicated the situation somewhat. Engesser (reference 5) had shown in the case of straight elastic columns how such rigid portions of equal lengths at freely supported ends could be treated rationally. The problem of the straight elastic column of uniform cross section elastically restrained against rotation at the ends had been treated by Nater and others (references 6, 7, and 8), and Bleich (reference 9) considered the case of the straight inelastic column so restrained. In the present investigation there were many slightly curved, inelastic columns with rigid portions and both with and without elastic restraints at the ends. All these columns were centered under load with the expectation that such

³ Christie (reference 3) was probably the first to compensate for imperfections in an actual column by shifting the ends of the column relative to the supports. Considère (reference 4) seems to have been the first to employ centering under load systematically in a series of column tests.

centering would idealize the elastically restrained columns as well as the freely supported columns.⁴ A rational method of determining the lengths, and thus the ratios of slenderness, of equally strong columns freely supported at the ends was then sought. The strength of the different columns could then be studied as a function of the ratio of slenderness based on the free lengths so found.

If the double-modulus theory (reference 2) of column action is adequate to describe the behavior of columns under load, as is being questioned less and less today, and if the departures from straightness of the columns are not too great, then it should be possible to determine the free length of any test column on the basis of this theory.⁵ If, when the free lengths of the test columns have been computed, plots of average stress at failure against ratio of slenderness based on the computed free length, or modifications of these quantities that take into account the variations in the properties of the material, lie on a reasonably smooth curve, this fact may be regarded as proof that small initial curvatures under conditions of proper centering do not affect the strengths of even inelastic columns freely supported or elastically restrained at the ends.

The equations determining the free length of an axially loaded straight column of uniform cross section with rigid portions and elastic restraints at the ends may be obtained as outlined in the following sections. The procedure is to write down the differential equation for the deflection of the center line, to integrate it, to introduce the boundary conditions, and to determine under what conditions the displacement of the center line becomes indeterminate. It will be found that this displacement becomes indeterminate at a definite load, the buckling load.

The notation that will be used is:

- A , the cross-sectional area of the column
 - i , the least radius of inertia or radius of gyration of the cross section of the column measured parallel to the plane of bending.
- $$I = Ai^2$$
- l , the length of the column specimen.
 - s_0 , the length of the rigid portion between the upper end of the specimen and the upper knife edge.
 - s_1 , the length of the rigid portion between the lower end of the specimen and the lower knife edge.

⁴ Well-known tests by von Kármán (reference 10) show that slight imperfections such as small initial curvatures do not affect the strengths of freely supported columns when centered under load. Zimmermann (reference 11) has shown theoretically that the strength of elastic columns is not affected by slight initial curvature when the columns are centered properly, and Rein (reference 12), in a careful series of tests, has included some definitely bent columns of structural steel, confirming Zimmermann's results.

⁵ In this theory it is assumed that the columns are straight, that the material is homogeneous, that the load is applied in line with the axis of the column, and that deformations due to shear are negligible. Since the behavior of a material stressed beyond the proportional limit in a column depends upon its previous strain history, the strength of columns in which the material is so stressed depends on the loading history. A standard loading history must therefore also be assumed in the theory. It is assumed that the compression is uniform over all the cross section until the buckling load is reached, and not until then does bending take place.

- P , the load on the column at failure by buckling.
- F , the transverse force acting at each knife edge on the ends of the column.
- \bar{E} , the double modulus.
- m_0 , the elastic restraint resisting rotation at the top end of the column.
- m_1 , the elastic restraint resisting rotation at the bottom end of the column.
- ψ_0 , the rotation at the top end of the column, positive clockwise.
- ψ_1 , the rotation at the bottom end of the column, positive clockwise.
- $M_0 = m_0\psi_0$, the restraining moment at the top end of the column.
- $M_1 = -m_1\psi_1$, the restraining moment at the bottom end of the column.

With the coordinate axes taken as in figure 6 the differential equation of the deflected center line of the column is for small deflections⁶,

$$\frac{d^2y}{dx^2} = \frac{M}{EI} \quad (1)$$

where M is the bending moment at any section,

$$M = M_0 + F(s_0 + x) - Py$$

Integration of equation (1) and substitution of the boundary conditions, $x=0: \frac{dy}{dx} = \psi_0, y = s_0\psi_0; x=l: \frac{dy}{dx} =$

$\psi_1, y = -s_1\psi_1$, yields four homogeneous linear equations in ψ_0, ψ_1 , and two constants of integration. The deflection y becomes indeterminate when the determinant of the coefficients in these equations is equal to zero, and hence the buckling load is defined by the equation

$$\Delta = 0$$

Upon evaluation of the determinant, there is found in terms of the nondimensional variables

$$\phi = l\sqrt{\frac{P}{EI}}$$

$$\mu_0 = \frac{m_0}{Pl\left(1 + \frac{s_0}{l} + \frac{s_1}{l}\right)} \text{ and } \mu_1 = \frac{m_1}{Pl\left(1 + \frac{s_0}{l} + \frac{s_1}{l}\right)}$$

$$\begin{aligned} & \left[1 + \mu_0 + \mu_1 - \phi^2 \left[\frac{s_0 s_1}{l^2} - \frac{s_1}{l} \left(1 + \frac{s_1}{l} \right) \mu_0 - \frac{s_0}{l} \left(1 + \frac{s_0}{l} \right) \mu_1 \right. \right. \\ & \left. \left. + \left(1 + \frac{s_0}{l} + \frac{s_1}{l} \right) \mu_0 \mu_1 \right] \right] \sin \phi - \phi \left[\mu_0 - \frac{s_0}{l} + \mu_1 - \frac{s_1}{l} \right. \\ & \left. + 2 \left(1 + \frac{s_0}{l} + \frac{s_1}{l} \right) \mu_0 \mu_1 \right] \cos \phi + 2 \left(1 + \frac{s_0}{l} + \frac{s_1}{l} \right) \mu_0 \mu_1 \phi = 0 \quad (2) \end{aligned}$$

⁶ It may be noted that equation (1) applies to any column that remains straight up to the instant of failure as in the standard loading history. In this case the average stress is constant and hence \bar{E} is independent of x .

If the length of a freely supported column having the same strength as the given column is denoted by l_0 , then

$$P = \frac{\pi^2 \bar{E} I}{l_0^2} \quad (3)$$

(the original double-modulus equation), and this equation makes it possible to write

$$\phi = \frac{\pi l}{l_0} \quad (4)$$

Equations (2) and (4) determine ϕ and l_0 when the other quantities are known.

It should be noted that the determination of the free length l_0 does not require a knowledge of the value of

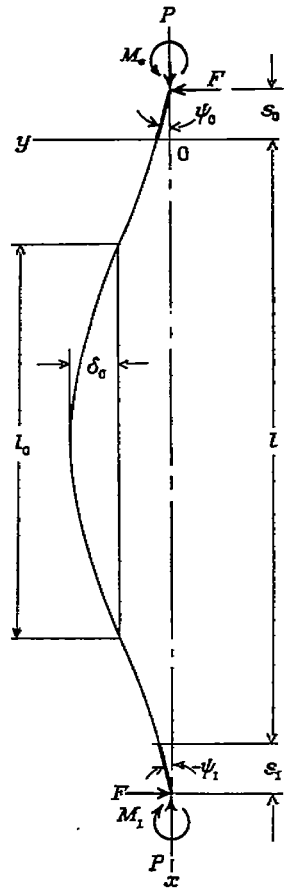

FIGURE 6.—Deflected center line of column.

\bar{E} , the free length being determined solely by the lengths l, s_0 , and s_1 and the variables μ_0 and μ_1 .

Equation (2) is simplified considerably in certain special cases. Thus, when $s_0 = s_1 = s$ and $\mu_0 = \mu_1 = \mu$, introduce the nondimensional variables

$$v = \left(1 + \frac{2s}{l} \right) \mu - \frac{s}{l} = \frac{m}{Pl} - \frac{s}{l} \quad (5)$$

and

$$\nu' = \frac{\mu - \frac{s}{l}}{1 + \frac{2s}{l}} = \frac{m - \frac{s}{l}}{\frac{Pl}{l} - \frac{s}{l} \left(1 + \frac{2s}{l}\right)} \quad (6)$$

and by factoring the left-hand side obtain

$$\left(\frac{1 + \cos \phi}{\sin \phi} + \nu\phi\right) [(1 + 2\nu')(1 - \cos \phi) - \nu'\phi \sin \phi] = 0 \quad (7)$$

It may be noted that if $\phi = 2n\pi$, where n is an integer, the left-hand side of this equation becomes indeterminate. Substitution of this value of ϕ into the original equation, (2), shows that $\phi = 2n\pi$ is not a solution. If the first of the factors on the left-hand side of equation (7) is equated to zero, the solution obtained corresponds to the case $\psi_0 = -\psi_1$ (fig. 6) and, if the second factor is equated to zero, the solution obtained corresponds to the case $\psi_0 = \psi_1$. The first solution yields the smallest value of ϕ and is the only one of practical interest. There is obtained then in a convenient form

$$\cot \frac{\phi}{2} + \nu\phi = 0 \quad (8)$$

Equation (8) may also be written in terms of the trigonometric functions

$$s = \frac{\phi}{\sin \phi} - 1 \text{ and } t = 1 - \frac{\phi}{\tan \phi} \quad (9)$$

$$t + s = -\frac{1}{\nu} \quad (8a)$$

Where tables of $t+s$ (reference 13) are available, equation (8a) will be the most convenient form for use.

If, when $s_0 = s_1 = s$ and $\mu_0 = 0$, there is introduced the nondimensional variable

$$\nu'' = \frac{\mu_1 - \frac{2s}{l}}{1 + \frac{2s}{l}} = \frac{m_1 - \frac{2s}{l}}{\frac{Pl}{l} - \frac{2s}{l} \left(1 + \frac{2s}{l}\right)} \quad (10)$$

equation (2) for the determination of ϕ reduces to

$$t = -\phi^2 \frac{s}{l} \left(1 + \frac{s}{l} + \frac{1}{\nu''} \frac{s}{l}\right) - \frac{1}{\nu''} \quad (11)$$

which may be solved by trial with the aid of table VII.

Finally, if $s_0 = s_1 = 0$, equation (2) may be written in the form

$$\mu_0 \mu_1 (t^2 - s^2) + (\mu_0 + \mu_1)t + 1 = 0 \quad (12)$$

Zimmermann (reference 13) gives this equation and Prager (reference 14) gives it in a modified form, but they assume it to apply for elastic buckling only. It has also been presented in a paper by the author (reference 15). The equation may be solved by trial with the aid of table VII, or it may be solved directly

by means of the nomogram (fig. 7) the idea for which is due to L. B. Tuckerman.⁷

In order to use the nomogram, a straight line is run through the points of the circle determined by the values of μ_0 and μ_1 read on the circular scale. This line will intersect the spiral curve in at least one point. The value of ϕ/π corresponding to this point, or the lower value if there are two intersections,⁸ read on the scale of the spiral curve will be the lowest value for which buckling can occur.

The necessary constants for the column specimens with equal (or no) restraints at opposite ends and for the column specimens freely supported at the top and restrained at the bottom being computed, equations (8), or (8a), and (11) could be solved for ϕ and the free lengths determined from equation (4). The ratios of slenderness, l_0/i could now be found; and the corresponding average stresses at failure, P/A , were obtained from the maximum loads and the cross-sectional areas. The values of m and m_1 that were used ranged from 0 to about 450,000 lb.-in. per radian. (See table I.)

COLUMN DATA

The values of ratio of slenderness, l_0/i , and corresponding average stress, P/A , are given in table II and are plotted for the chromium-molybdenum-steel specimens in figure 8, for the duralumin specimens in figure 9, for the round stainless-steel specimens in figure 10, and for the heat-treated chromium-molybdenum-steel specimens in figure 11. One of the main causes, probably the main cause, of the scatter in the points in these diagrams is the unavoidable variation in the properties of the material from tube to tube and along the length of any one tube from which specimens were cut.—This variability can be corrected for to the extent to which the compressive stress-strain relations remain invariable along the length of any one given specimen and are affinely related from specimen to specimen.

Suppose, for example, that there is determined from the compressive stress-strain diagram of the material in each specimen a certain stress, S , as the intersection with the stress-strain curve of a line through the origin having a slope βE , where β is a constant for a given material and $0 < \beta < 1$, and E is the modulus of elasticity of the material. Let there now be constructed in each case a reduced compressive stress-strain diagram in which there is plotted, instead of stress against strain, stress divided by S against strain divided by S/E .⁹

⁷ Equation (12) is in one of Clark's canonical forms of equations of nomographic order 4. (See reference 16.)

⁸ In the case of two points of intersection the higher value of ϕ/π corresponds to an unstable condition of equilibrium.

⁹ The reduced stress-strain diagram has been used by Hohenemser (reference 17), who does not, however, determine S specifically by the method here used.

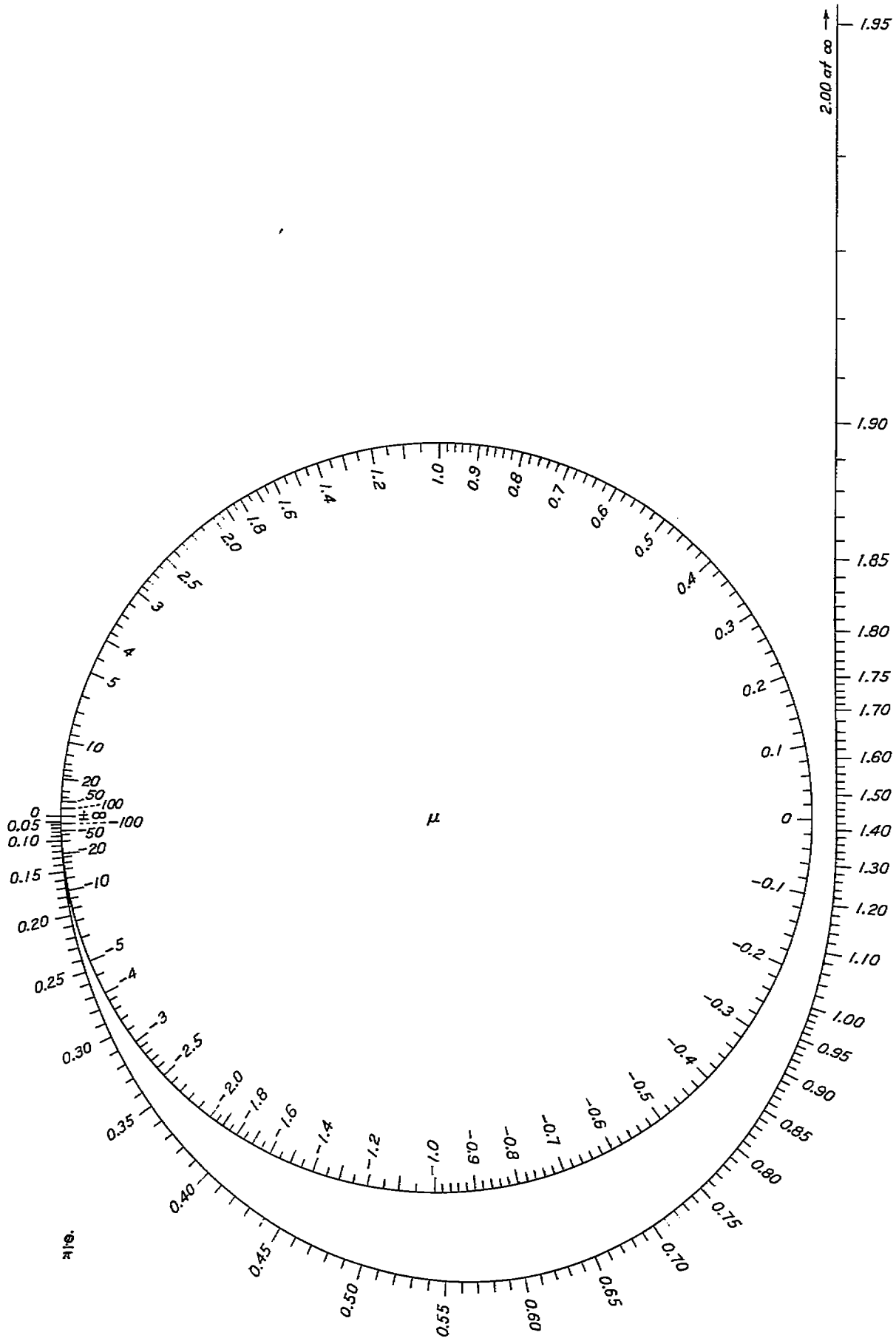

FIGURE 7.—Nomogram for determining ϕ/π when two values of μ are given.

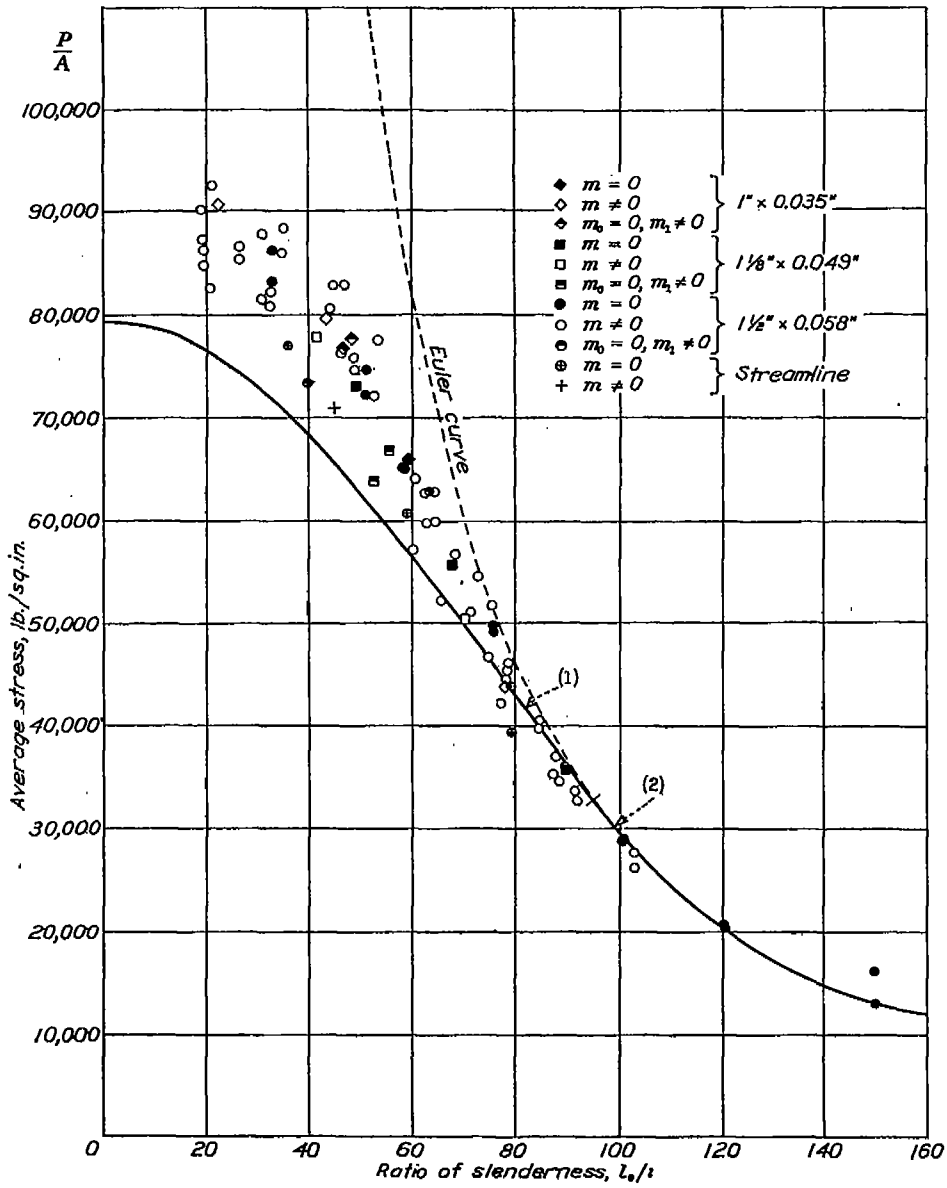

FIGURE 8.—The $\frac{l_e}{l}, \frac{P}{A}$ —diagram for chromium-molybdenum-steel tubes.

$$(1) \frac{P}{A} = 78,000 - \frac{22,000 - \left(\frac{l_e}{l}\right)^2}{20,700 + \left(\frac{l_e}{l}\right)^2}$$

$$(2) \frac{P}{A} = \frac{294,000,000}{\left(\frac{l_e}{l}\right)^2}$$

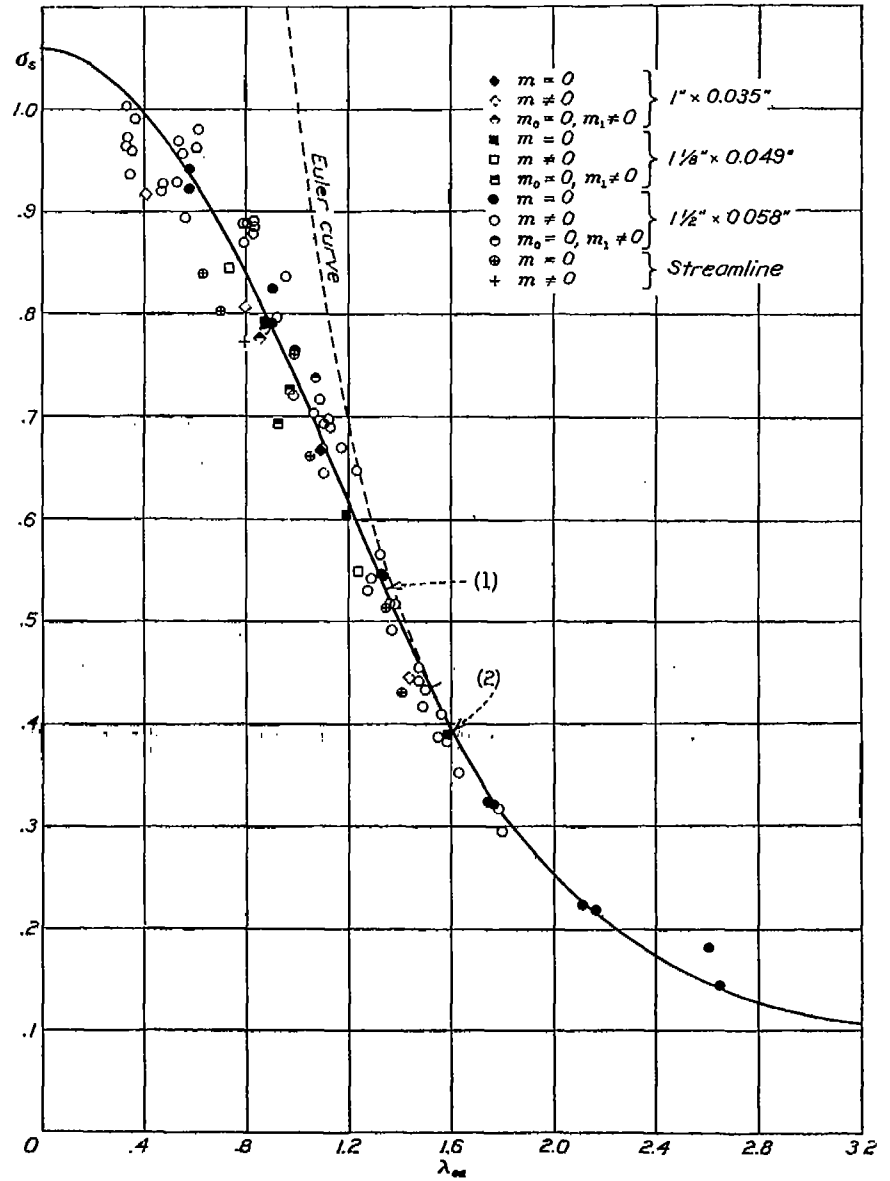

FIGURE 12.—The λ_m, σ_c —diagram for chromium-molybdenum-steel tubes.

$$(1) \sigma_c = \frac{8.6 - \lambda_m^2}{5.29 + \lambda_m^2}$$

$$(2) \sigma_c = \frac{1}{\lambda_m^2}$$

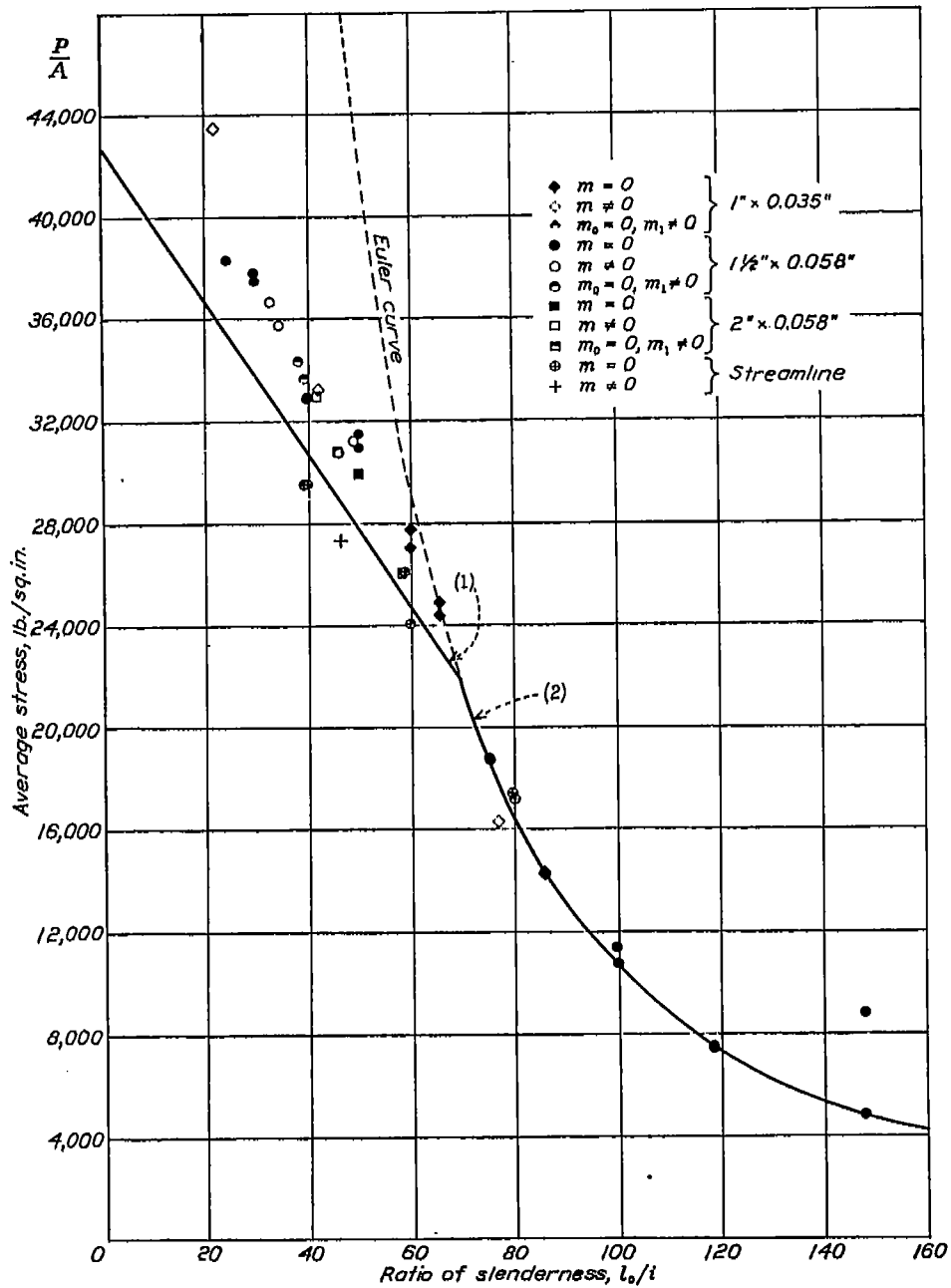

FIGURE 9.—The $\frac{l_0}{t}, \frac{P}{A}$ —diagram for duralumin tubes.

$$(1) \frac{P}{A} = 42,700 \left(1 - 0.00707 \frac{l_0}{t} \right) \quad (2) \frac{P}{A} = \frac{104,500,000}{\left(\frac{l_0}{t} \right)^2}$$

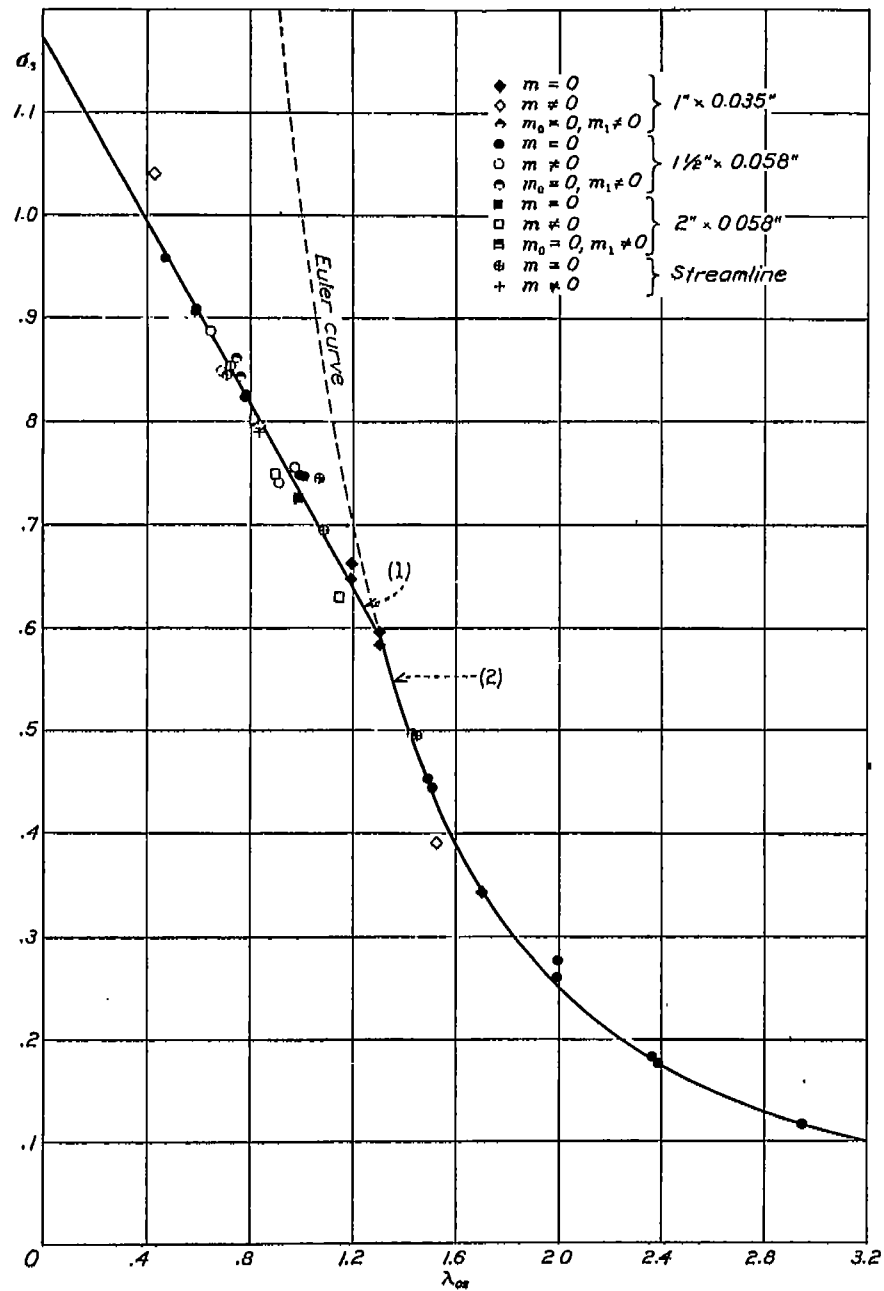

FIGURE 13.—The λ_{0c}, σ_c —diagram for duralumin tubes.

$$(1) \sigma_c = 1.175 - 0.445 \lambda_{0c} \quad (2) \sigma_c = \frac{1}{\lambda_{0c}^2}$$

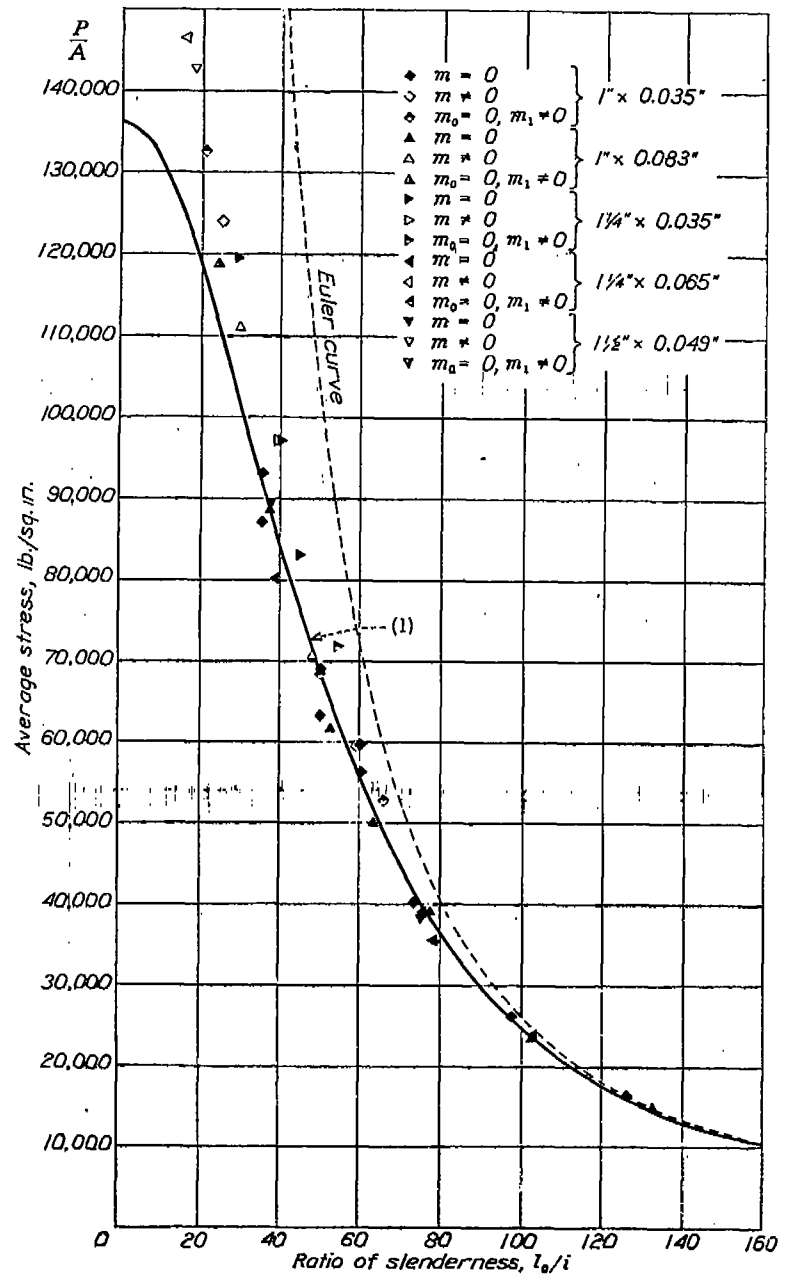

FIGURE 10.—The $\frac{l_0}{i} \frac{P}{A}$ diagram for stainless-steel tubes.

$$(1) \frac{P}{A} = \frac{123,400}{0.000328 \left(\frac{l_0}{i}\right)^2 + 0.32 \sqrt{0.00000226 \left(\frac{l_0}{i}\right)^4 + 8}}$$

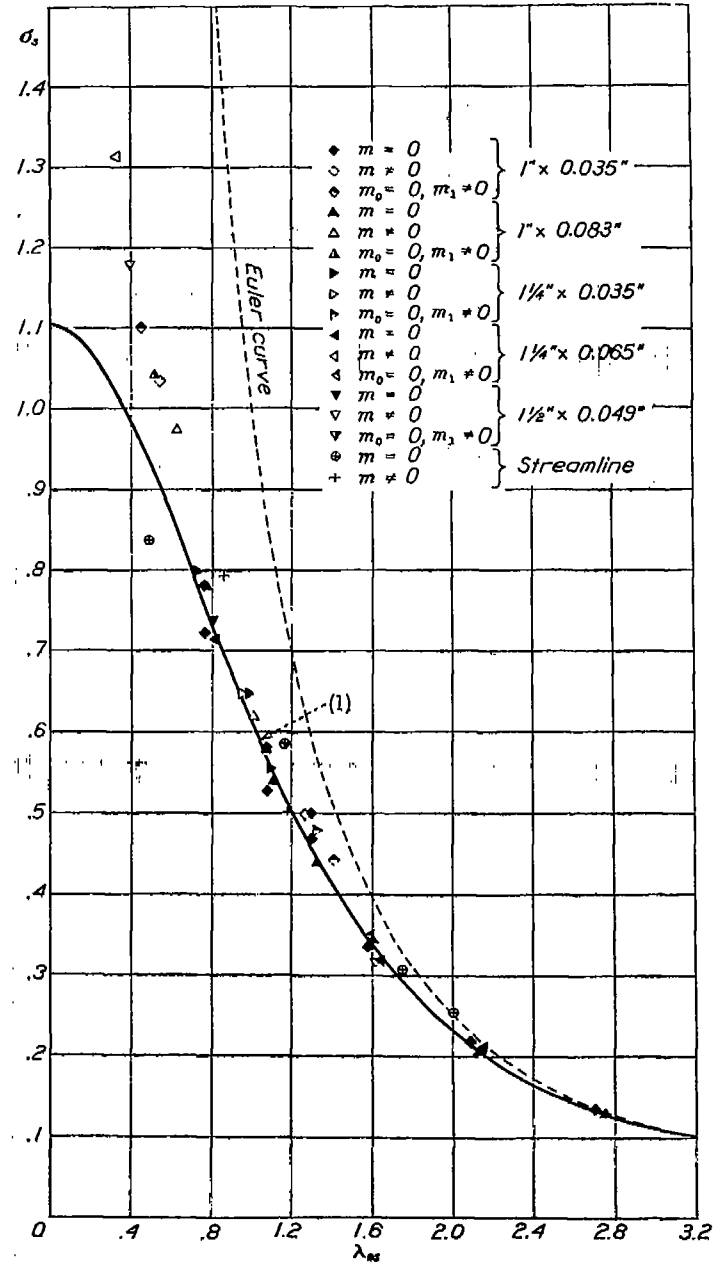

FIGURE 14.—The $\lambda_{0s} \sigma_s$ diagram for stainless-steel tubes.

$$(1) \sigma_s = \frac{1}{0.000328 \lambda_{0s}^2 + 0.32 \sqrt{\lambda_{0s}^4 + 8}}$$

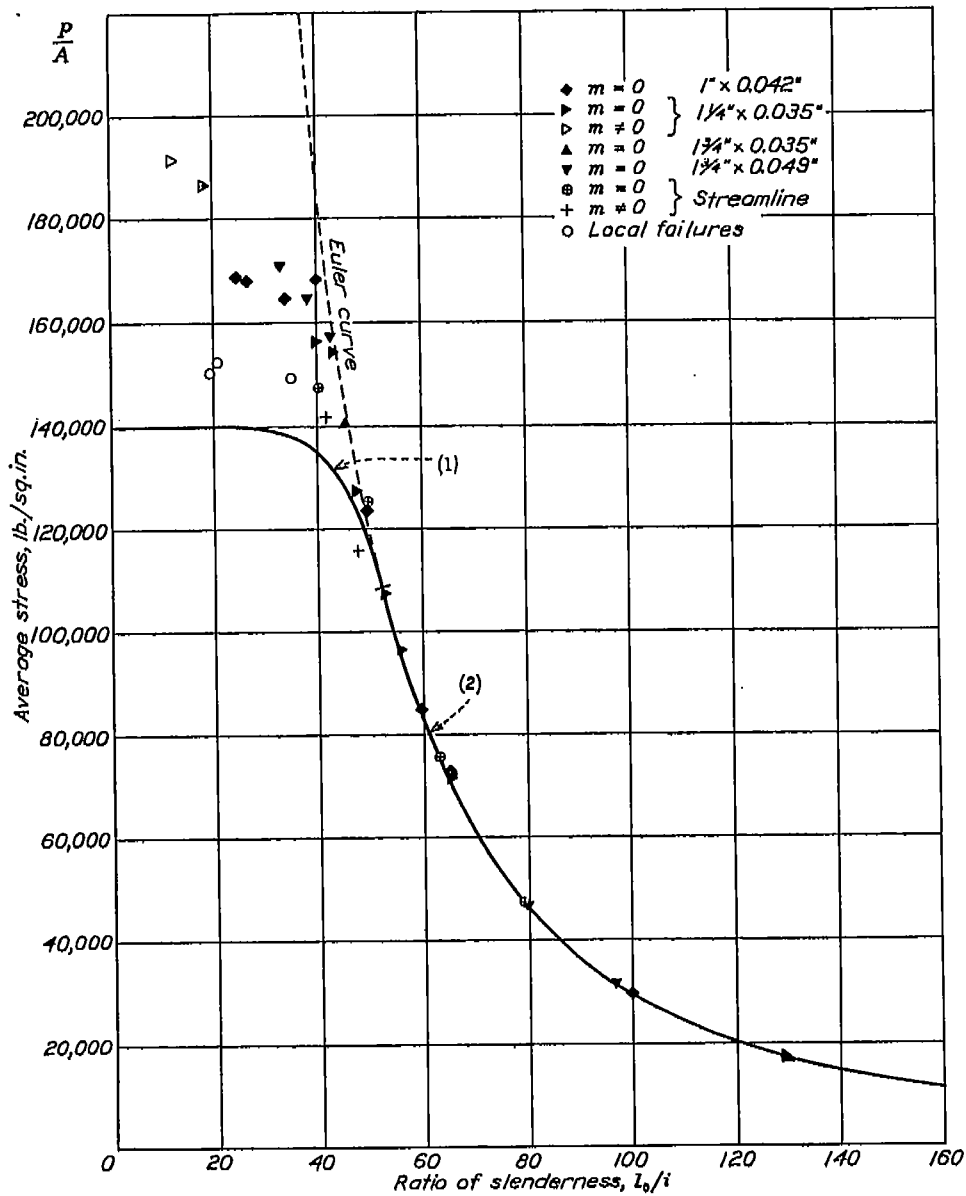

FIGURE 11.—The $\frac{L_0}{i}, \frac{P}{A}$ —diagram for heat-treated chromium-molybdenum-steel tubes.

$$(1) \frac{P}{A} = 140,000 \left[1 - \left(0.0155 \frac{L_0}{i} \right)^2 \right]$$

$$(2) \frac{P}{A} = \frac{296,100,000}{\left(\frac{L_0}{i} \right)^2}$$

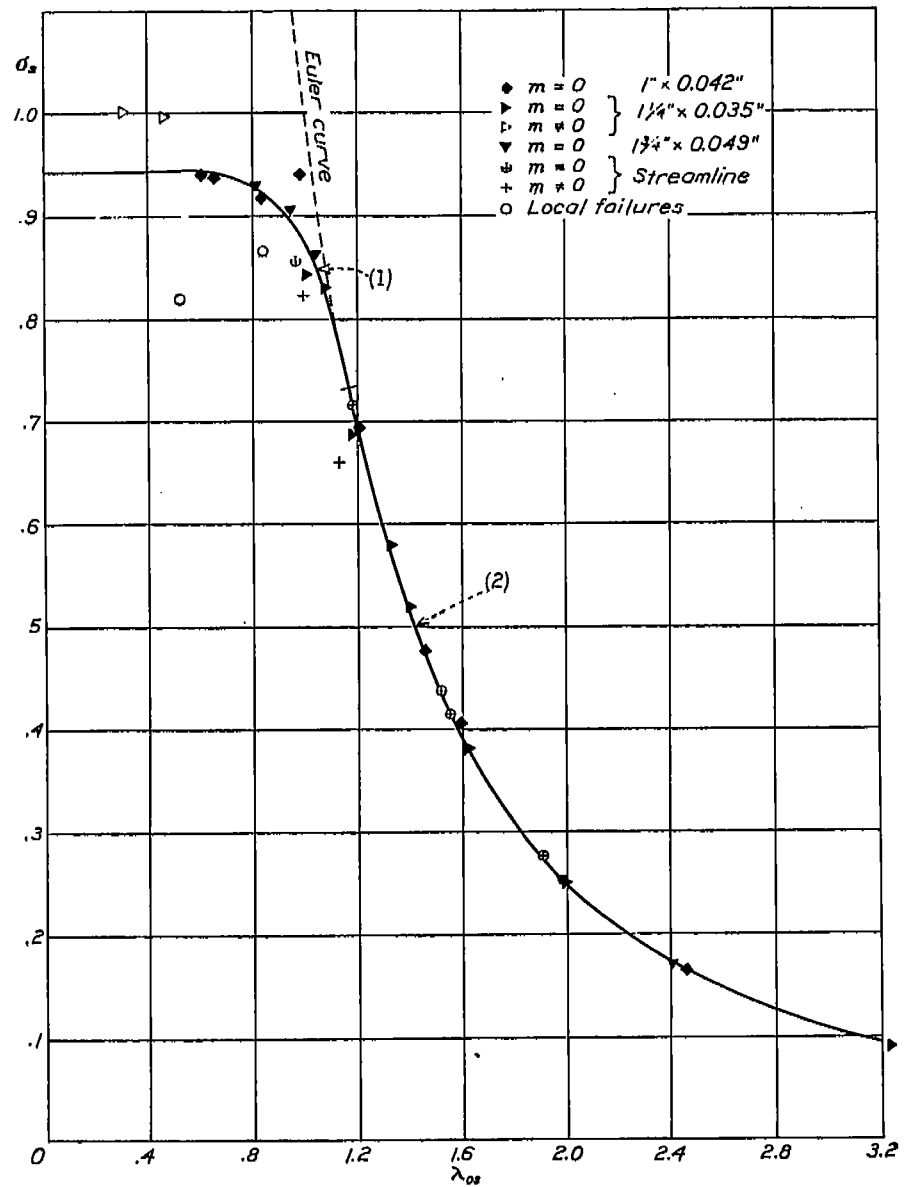

FIGURE 15.—The λ_{as}, σ_a —diagram for heat-treated chromium-molybdenum-steel tubes.

$$(1) \sigma_a = 0.948 \left(1 - 0.0750 \lambda_{as}^2 \right)$$

$$(2) \sigma_a = \frac{1}{\lambda_{as}^2}$$

If the various original stress-strain curves are affinely related,¹⁰ then they all reduce to one and the same curve, in particular, that part of the reduced diagram within the elastic range is identical for all materials. Just as there is corresponding to any given stress-strain curve, a definite double-modulus column curve, $P/A = \pi^2 \bar{E} / (l_0/i)^2$, so there is corresponding to our reduced stress-strain curve, a definite reduced double-modulus column curve in which P/A and \bar{E} in the double-modulus formula are replaced by $P/(AS)$ and \bar{E}/E , respectively, and in which l_0 must be replaced by $l_0 \sqrt{S/\bar{E}}$.¹¹

If now there are introduced the nondimensional variables¹²

$$\lambda_{os} = \frac{1}{\pi^2} \frac{l_0}{i} \sqrt{\frac{S}{\bar{E}}} \quad \sigma_s = \frac{P}{AS} \quad (13)$$

the reduced column curve

$$\sigma_s = \frac{\bar{E}}{\lambda_{os}^2 E} \quad (14)$$

is identically the same for all columns having geometrically similar cross sections (\bar{E} depends among other things on the shape of the cross section) and made of materials having compressive stress-strain diagrams that are affinely related.

Although it is too much to expect all the compressive stress-strain curves of a material to be affinely related, nevertheless they are to some degree of approximation so related; and experience has shown that, where the properties of the material differ widely, the correction proposed is a real correction (reference 18). Accordingly, the values of λ_{os} and σ_s , equations (13), were computed for each column specimen. For \bar{E} in each case was used the modulus of elasticity of the compressive specimen for the tube from which the column specimen was cut. For the determination of S , which may be called the "compressive yield strength", in the case of the chromium-molybdenum steel and the duralumin tubes, β was so chosen that were the tensile yield strength to be determined for a material just passing specifications, then by the βE method exactly the same yield strength would be obtained as by the method specified for round tubing. This consideration gave $\beta = \frac{5}{9}$ for the chromium-molybdenum steel and $\beta = \frac{2}{3}$ for the duralumin. The value of β determined in the same way for the $\frac{1}{4}$ -H stainless steel gave $\beta = \frac{27}{37}$; this value was arbitrarily reduced to $\frac{5}{8}$, which was the value used for all the stainless-steel specimens. For the heat-treated chromium-molybdenum steel $\beta = \frac{5}{7}$ was used. This value would correspond to a specified yield strength of 150,000 lb. per sq. in., determined as indi-

cated in footnote 1. For curves that are strictly affinely related the value of β is immaterial, within the limits $0 < \beta < 1$ within which it has any meaning. For curves that are approximately affinely related the best value of β is that value which most nearly brings them all to the same reduced stress-strain curve, but practically the best value may be regarded as the value which is most effective in reducing the scatter in the l_0/i , P/A -diagrams. In order to make sure that the values of β adopted were reasonably good, other values were tried: $\frac{1}{2}$ for chromium-molybdenum steel and duralumin, and $\frac{2}{37}$ and $\frac{1}{2}$ for stainless steel. There was little difference in the results, which were not made significantly better nor worse. This result was to be expected, for in order that the method have any value at all, the stress-strain curves must show some semblance of affine relationship, and if they do, the value of β most convenient to use will be practically as good as any other.

The λ_{os}, σ_s -diagrams that result from the procedure just outlined are shown in figures 12, 13, 14, and 15. Comparisons of the chromium-molybdenum-steel diagrams (figs. 8 and 12) and the duralumin diagrams (figs. 9 and 13) show some improvement; but the improvement is most marked in the stainless steel and the heat-treated chromium-molybdenum-steel diagrams (figs. 10 and 14 and figs. 11 and 15). That the improvement is not greater in the chromium-molybdenum-steel results may be explained by the fact that the mechanical properties of the material vary considerably along the length of a given tube. The value of the compressive yield strength for a column specimen may differ appreciably from the value of the compressive yield strength as actually determined on the compressive specimen. Moreover, the compressive stress-strain curves of the chromium-molybdenum-steel showed comparatively poor affine relationship. No great improvement in the duralumin results would be expected because of the general uniformity of all the material used.

The next most probable cause of scatter in the l_0/i , P/A - and λ_{os}, σ_s -diagrams after variations in the properties of the materials, is the uncertainty of the conditions at the ends of the test columns. The best measure of the success with which a column has been centered is the subsequent load-deflection curve obtained on testing the column; or better, for comparative purposes, a plot of load, P , divided by maximum load, P_{max} , against deflection within the free length divided by the free length (reference 19). The sharper the "knee" of such a diagram, that is, the smaller the smallest-radius of curvature of the reduced load deflection curve, the better centered or the better adjusted the ends of the column may be assumed to have been. Representative diagrams of this kind are shown in figures 16 and 17. The deflection, δ_0 , in the free length was obtained from the observed deflections on the assumption that equation (1) represented the deflected center line.

¹⁰ By affine relation is meant the relation that exists between the curves $F(e, f) = 0$ and $F(pe, qf) = 0$, where p and q are constants.

¹¹ The quantity $l_0 \sqrt{S/\bar{E}}$ is the length of an elastic column which would buckle at the average stress S .

¹² Similar variables were used by Tuckerman, Petrenko, and Johnson (reference 18).

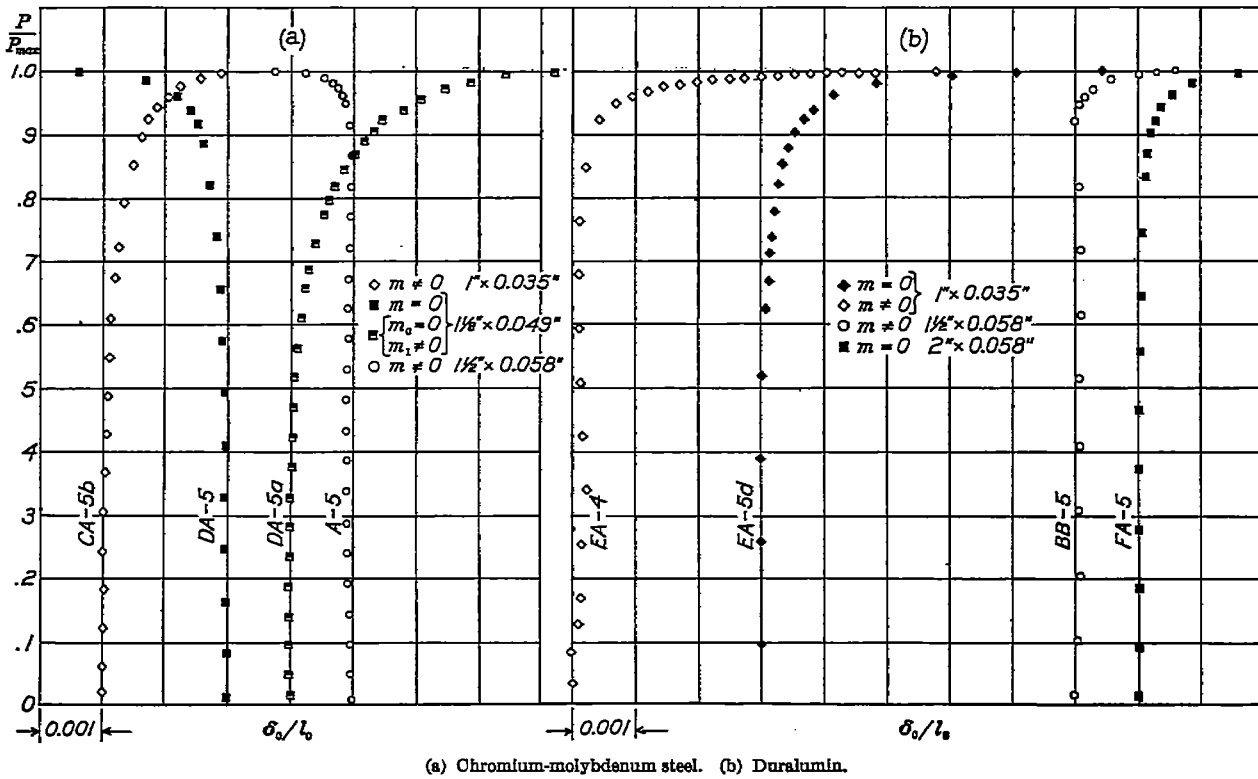

FIGURE 16.—Representative reduced load-deflection curves for chromium-molybdenum-steel and for duralumin tubes.

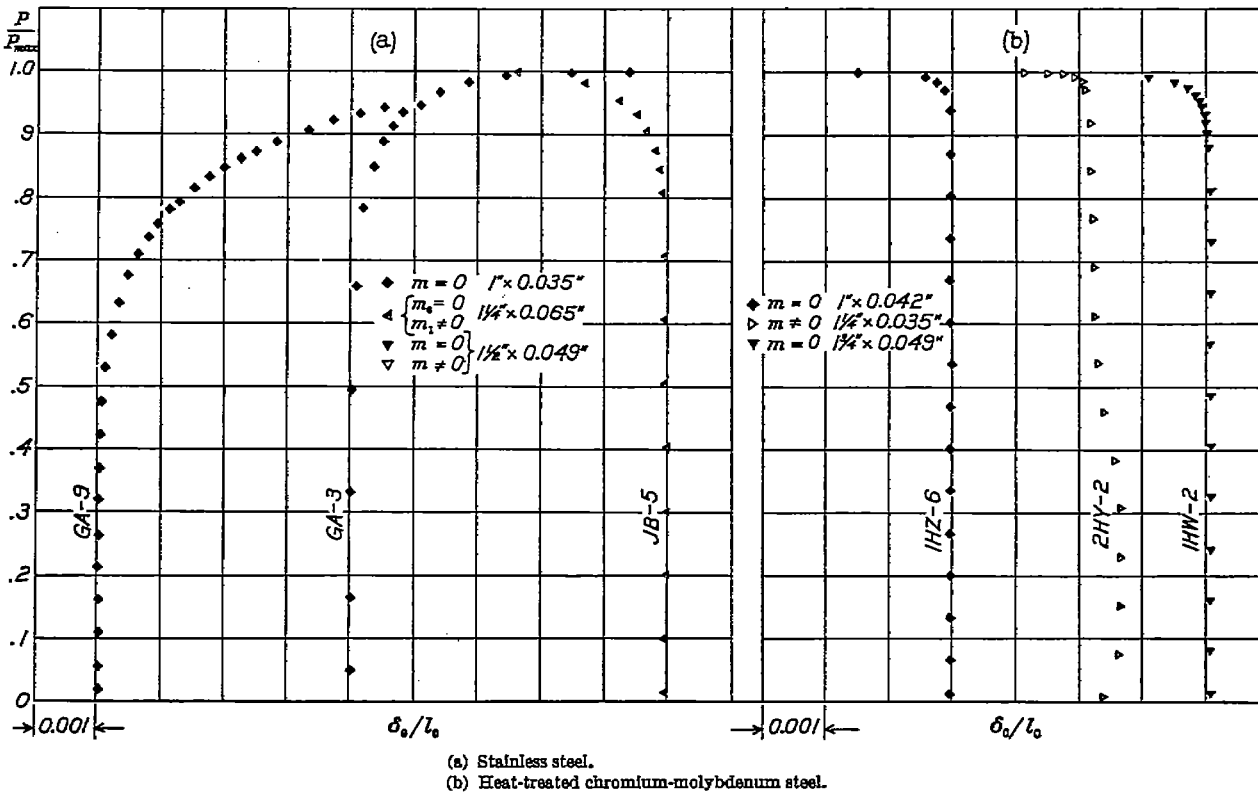

FIGURE 17.—Representative reduced load-deflection curves for stainless-steel and heat-treated chromium-molybdenum-steel tubes.

Comparison of the low points on the λ_{os}, σ_s -diagrams with the reduced load-deflection diagrams for the corresponding specimens indicated that one chromium-molybdenum-steel, three duralumin, four stainless-steel, and two heat-treated chromium-molybdenum-steel columns were probably tested with unsatisfactory end conditions, since the reduced load-deflection curves showed large radii of curvature at the knees.

The error in the free length, l_0 , due to an error in the restraint, m , was estimated to be not greater than 1 percent in any case.

The tests on freely supported round columns are regarded as the primary data, the tests with restrained ends and the tests of the streamline sections being regarded as check data. The degree to which the check data agree with the primary data is an indication of the accuracy of the method of computing free length by means of equations (4) and (8) or (11). It will be noted that, in general, in figures 12, 13, 14, and 15 the points representing the check data fall in approximately equal numbers above and below the point representing the primary data.

FORMULAS AND CURVES FOR DESIGNING

The data were adapted for use in designing by the following procedure. Empirical formulas were developed to give a good approximation to the λ_{os}, σ_s -values for each of the materials, curves representing these formulas being shown in figures 12, 13, 14, and 15. Use of these formulas or curves requires a knowledge of the compressive yield strength of the material, and this information is not usually available to the designer. The specified property most nearly related to it is the tensile yield strength. Therefore, the average ratios of compressive yield strength to tensile yield strength were determined for the several materials, and the values of the specified tensile yield strength in the several current specifications were introduced into the empirical equations to give the column strength as a function of ratio of slenderness for material just passing the specification. Curves representing these results are shown in figures 8, 9, 10, and 11. The details of this procedure will now be taken up.

The results of the tests on the freely supported round chromium-molybdenum-steel columns can be represented in the λ_{os}, σ_s -diagram by a curve of the form^{12a}

$$\sigma_s = \frac{K_0 - \lambda_{os}^2}{\frac{1}{4}(K_0 - K_1)^2 + K_1 \lambda_{os}^2} \text{ for } \frac{4K_0}{(K_0 - K_1)^2} \geq \sigma_s \geq \frac{2}{K_0 - K_1} \quad (15a)$$

and the reduced Euler curve

$$\sigma_s = \frac{1}{\lambda_{os}^2} \text{ for } \frac{2}{K_0 - K_1} \geq \sigma_s > 0 \quad (15b)$$

^{12a} This type of curve, in terms of the ratio of slenderness and the average stress, was proposed by Kretzger (reference 20).

where K_0 and K_1 are empirical constants. These curves are shown in figure 12 for $K_0=5.6$ and $K_1=1$:

$$\sigma_s = \frac{5.6 - \lambda_{os}^2}{5.29 + \lambda_{os}^2} \text{ for } \frac{560}{529} \geq \sigma_s \geq \frac{10}{23} \quad (16a)$$

$$\sigma_s = \frac{1}{\lambda_{os}^2} \text{ for } \frac{10}{23} \geq \sigma_s > 0. \quad (16b)$$

It may be noted that for $K_1=0$, equation (15a) reduces to the Johnson parabolic formula.

The results of the tests on the freely supported round duralumin columns can be represented in the λ_{os}, σ_s -diagram by the straight line and the reduced Euler curve

$$\sigma_s = 1.175 - 0.575\sqrt{0.6}\lambda_{os} \text{ for } 1.175 \geq \sigma_s \geq 0.6$$

$$\text{or } \sigma_s = 1.175 - 0.445\lambda_{os} \text{ for } 1.175 \geq \sigma_s \geq 0.6 \quad (17a)$$

$$\text{and } \sigma_s = \frac{1}{\lambda_{os}^2} \text{ for } 0.6 \geq \sigma_s > 0 \quad (17b)$$

which are shown in figure 13.

The results of the tests on the freely supported round stainless-steel columns can be represented in the λ_{os}, σ_s -diagram by a modification of a curve proposed by Aarflot¹³

$$\sigma_s = \frac{1}{K_2 \lambda_{os}^2 + (1 - K_2)\sqrt{\lambda_{os}^4 + K_3}}, K_2 \leq 1, K_3 \geq 0 \quad (18)$$

for all values of λ_{os} , K_2 and K_3 being empirical constants. The curve is shown in figure 14 for $K_2=0.68$, $K_3=8$:

$$\sigma_s = \frac{1}{0.68\lambda_{os}^2 + 0.32\sqrt{\lambda_{os}^4 + 8}} \quad (19)$$

It may be noted that for $K_2=1$ or $K_3=0$ equation (18) reduces to the Euler formula.

The results of the tests on the freely supported round heat-treated chromium-molybdenum-steel columns can be represented in the λ_{os}, σ_s -diagram by the seventh-degree parabola and the Euler curve,

$$\sigma_s = 0.943(1 - 0.0751\lambda_{os}^7) \text{ for } 0.943 \geq \sigma_s \geq 0.733 \quad (20a)$$

$$\sigma_s = \frac{1}{\lambda_{os}^2} \text{ for } 0.733 \geq \sigma_s > 0 \quad (20b)$$

which are shown in figure 15.

The relations between l_0/i and P/A , usually desired, may be obtained by substituting the values of λ_{os} and σ_s from (13) in (16a) to (20b), solving for P/A , and introducing the numerical values of the quantities S and E ; but this procedure would result in equations applicable only to the particular material tested. What is wanted are equations in l_0/i and P/A which give safe results when applied to any material passing specifications. The specified property most closely related to the compressive yield strength of a material is the tensile yield strength, and if the ratio of these two strengths is known for a particular material, a

¹³ Aarflot (reference 21) proposes

$$\sigma = \frac{1}{\frac{1}{2}\lambda^4 + \frac{1}{2}\sqrt{\lambda^4 + 4}}$$

column formula written in terms of the compressive yield strength may be given in terms of the specified yield strength. The average ratios of the compressive yield strength to the tensile yield strength for the round tubes of the four materials used in this investigation were found to be 1.000, 0.908, 0.827, and 1.120 for chromium-molybdenum steel, duralumin, stainless steel, and heat-treated chromium-molybdenum steel, respectively.

Navy Department Specification 44T18c for chromium-molybdenum-steel tubing requires a tensile yield strength not less than 75,000 lb. per sq. in. for tubing up to 0.188 inch thick. The compressive yield strength of tubing just passing this specification may be expected to be $S=1.000 \times 75000=75,000$ lb. per sq. in. The average value found for E for the round tubes was 29,800,000 lb. per sq. in. Consequently, the column strength in pounds per square inch of tubing up to 0.188 inch thick which passes the specification just mentioned and for which the ratio of diameter d to thickness t does not exceed about 50 (value obtained from unpublished tests on short specimens) may be represented by the formulas

$$\frac{P}{A} = 75000 \frac{22000 - \left(\frac{l_0}{i}\right)^2}{20700 + \left(\frac{l_0}{i}\right)^2} \text{ for } 79400 \geq \frac{P}{A} \geq 32600, \quad (21a)$$

$$\frac{P}{A} = \frac{294\,000\,000}{\left(\frac{l_0}{i}\right)^2} \text{ for } 32600 \geq \frac{P}{A} > 0. \quad (21b)$$

Curves corresponding to these formulas are shown in figure 8. They represent the strength that may be expected from tubes which just pass the specification.

Navy Department Specification 44T21b for heat-treated duralumin tubing requires a tensile yield strength not less than 40,000 lb. per sq. in. The compressive yield strength of tubing just passing this specification may be expected to be $S=0.908 \times 40000=36,320$ lb. per sq. in. The average value found for E for the round tubes was 10,590,000 lb. per sq. in. Consequently, the column strength in pounds per square inch of tubing which passes the specification just mentioned and for which the ratio of diameter d to thickness t does not exceed 55 (value obtained from unpublished tests on short specimens) may be represented by the formulas.

$$\frac{P}{A} = 42700 \left(1 - 0.00707 \frac{l_0}{i}\right) \text{ for } 42700 \geq \frac{P}{A} \geq 21800 \quad (22a)$$

$$\frac{P}{A} = \frac{104\,500\,000}{\left(\frac{l_0}{i}\right)^2} \text{ for } 21800 \geq \frac{P}{A} \geq 0. \quad (22b)$$

Curves corresponding to these formulas are shown in figure 9. They represent the strength that may be expected from tubes which just pass the specification.

Navy Department Specification 44T27 (INT) for stainless-steel tubing, 3/4 H—Cold drawn, requires a tensile yield strength not less than 135,000 lb. per sq. in. The compressive yield strength of tubing just passing

this specification may be expected to be $S=0.827 \times 135000=111,600$ lb. per sq. in. The average value found for E for the round tubes was 26,300,000 lb. per sq. in. Consequently, the column strength in pounds per square inch of tubing which passes the specification just mentioned and for which the ratio of diameter d to thickness t does not exceed about 35 (see table I) may be represented by the formula

$$\frac{P}{A} = \frac{123\,400}{\left(0.01798 \frac{l_0}{i}\right)^2 + \sqrt{1 + \left(0.01233 \frac{l_0}{i}\right)^2}} \quad (23)$$

The curve represented by this formula is shown in figure 10. It represents the strength that may be expected from tubes which just pass the specification.

As stated previously, no specifications apply to the heat-treated chromium-molybdenum-steel tubing, but all the tensile specimens showed a yield strength above 150,000 lb. per sq. in. determined as indicated in footnote 1. The variation in the ratios of compressive yield strength to tensile yield strength was so great, more than 20 percent, and the number of tubes, five, from which specimens were cut was so small that instead of using the average ratio for this material, it seems desirable from considerations of safety to use the least ratio found of compressive yield strength to tensile yield strength, namely, 0.99, in obtaining a relation between P/A and l_0/i based on a specified tensile yield strength. If a specified minimum tensile yield strength of 150,000 lb. per sq. in. is assumed, the compressive yield strength of tubing just passing the specification may be expected to be $S=0.99 \times 150000=148,500$ lb. per sq. in. The average value found for E for the round tubes was 30,000,000 lb. per sq. in. Consequently, the column strength in pounds per square inch of heat-treated chromium-molybdenum-steel tubing similar to that tested, having a specified minimum tensile yield strength of 150,000 lb. per sq. in., for which the ratio of diameter d to thickness t does not exceed about 35¹⁴ (see table I) may be represented by the formulas

$$\frac{P}{A} = 140000 [1 - (0.01547 l_0/i)^2] \text{ for } 140000 \leq \frac{P}{A} \leq 108900 \quad (24a)$$

$$\frac{P}{A} = \frac{296\,100\,000}{\left(\frac{l_0}{i}\right)^2} \text{ for } 108900 \geq \frac{P}{A} > 0 \quad (24b)$$

Curves represented by these formulas are shown in figure 11. They represent the strength that may be expected from tubes which just pass a specification requiring a minimum tensile yield strength of 150,000 lb. per sq. in.

¹⁴ It is true that one column specimen with $d/t=35.7$ failed by crinkling at one end but this specimen was the shortest one tested with so high a value of d/t . Five other longer specimens with the same value of d/t , two of them cut from the same tube as the specimen in question, failed by primary buckling at higher average stresses. It is extremely difficult to center a short specimen because the deflections under the centering load are so small. This condition is not of great importance for such specimens when failure occurs by primary buckling, but it is likely to affect appreciably the average stress at failure when the failure is by crinkling. It seems probable, therefore, that the specimen mentioned was loaded eccentrically, and that the strength does not represent the strength which would have been obtained under a centrally applied load.

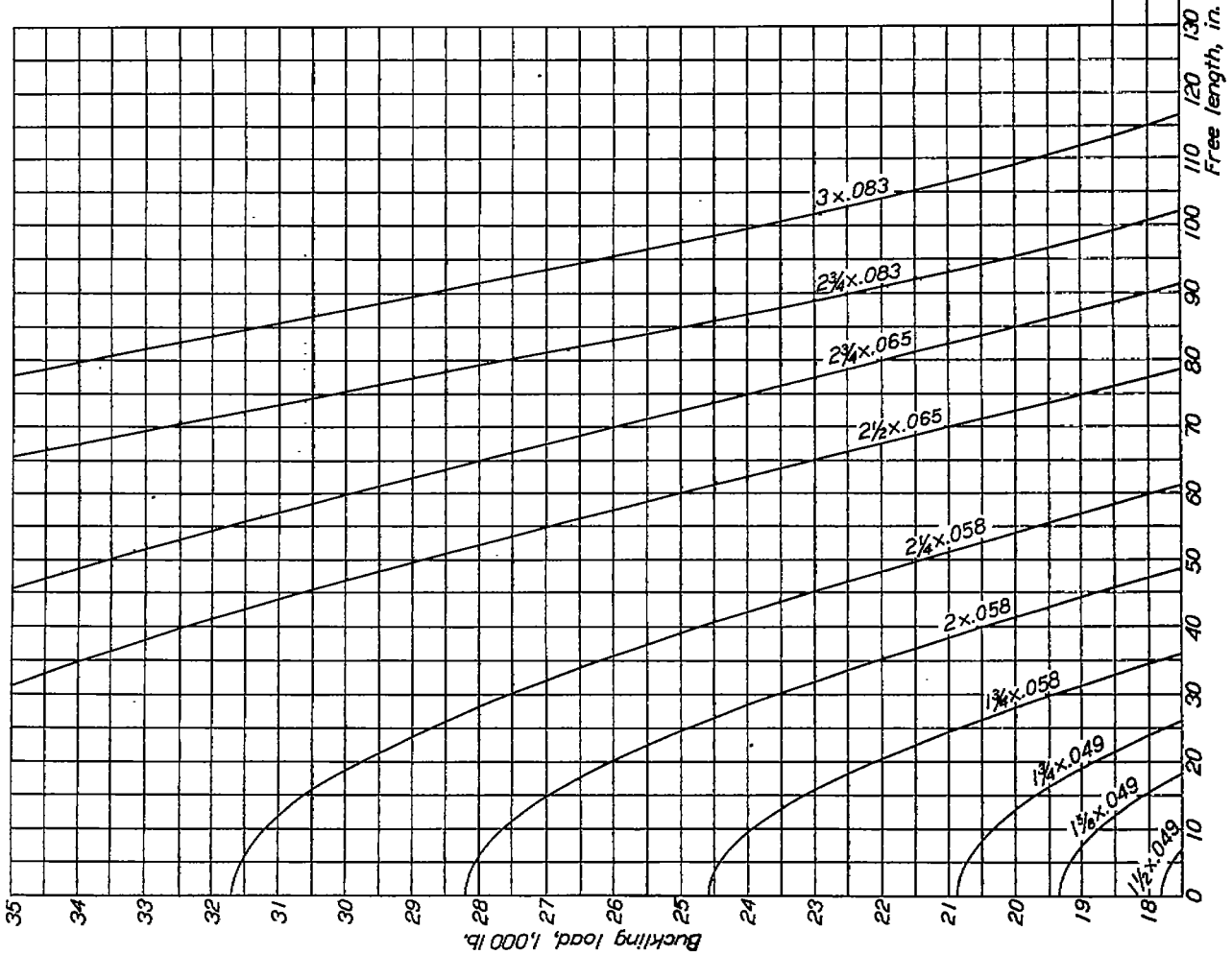
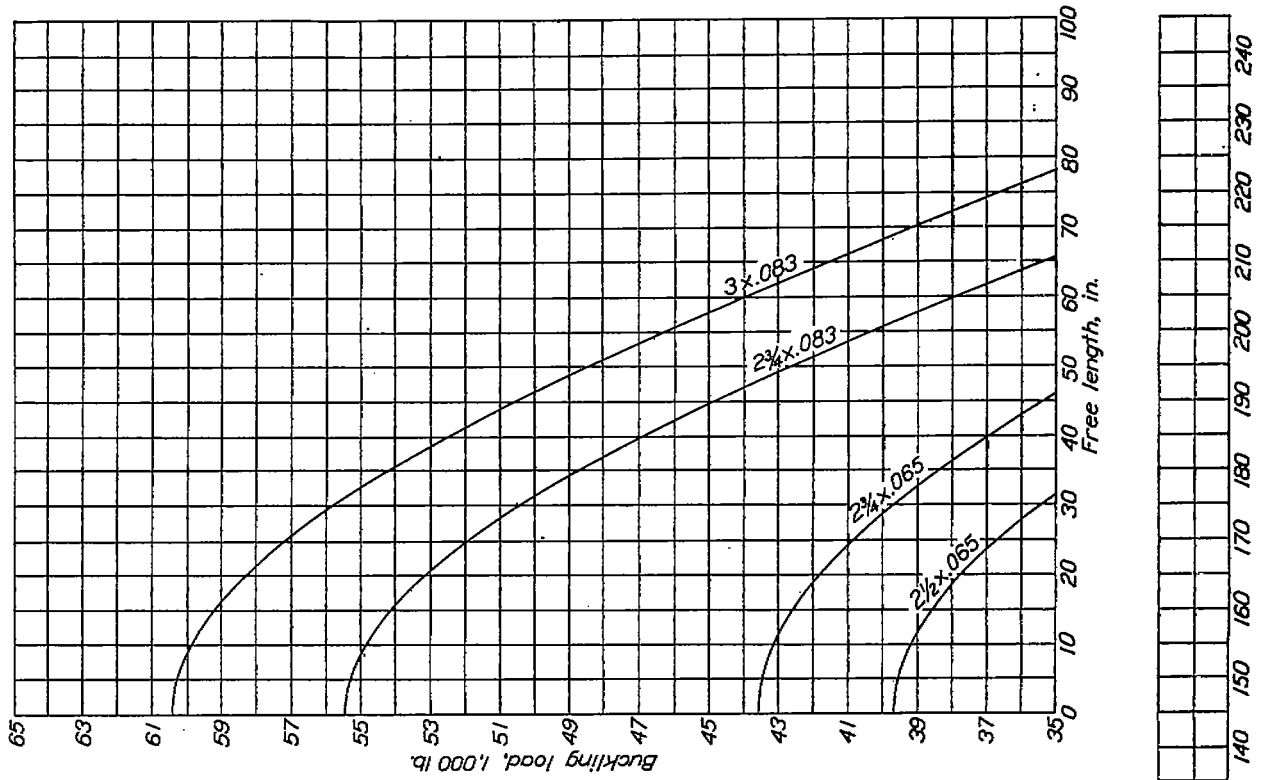

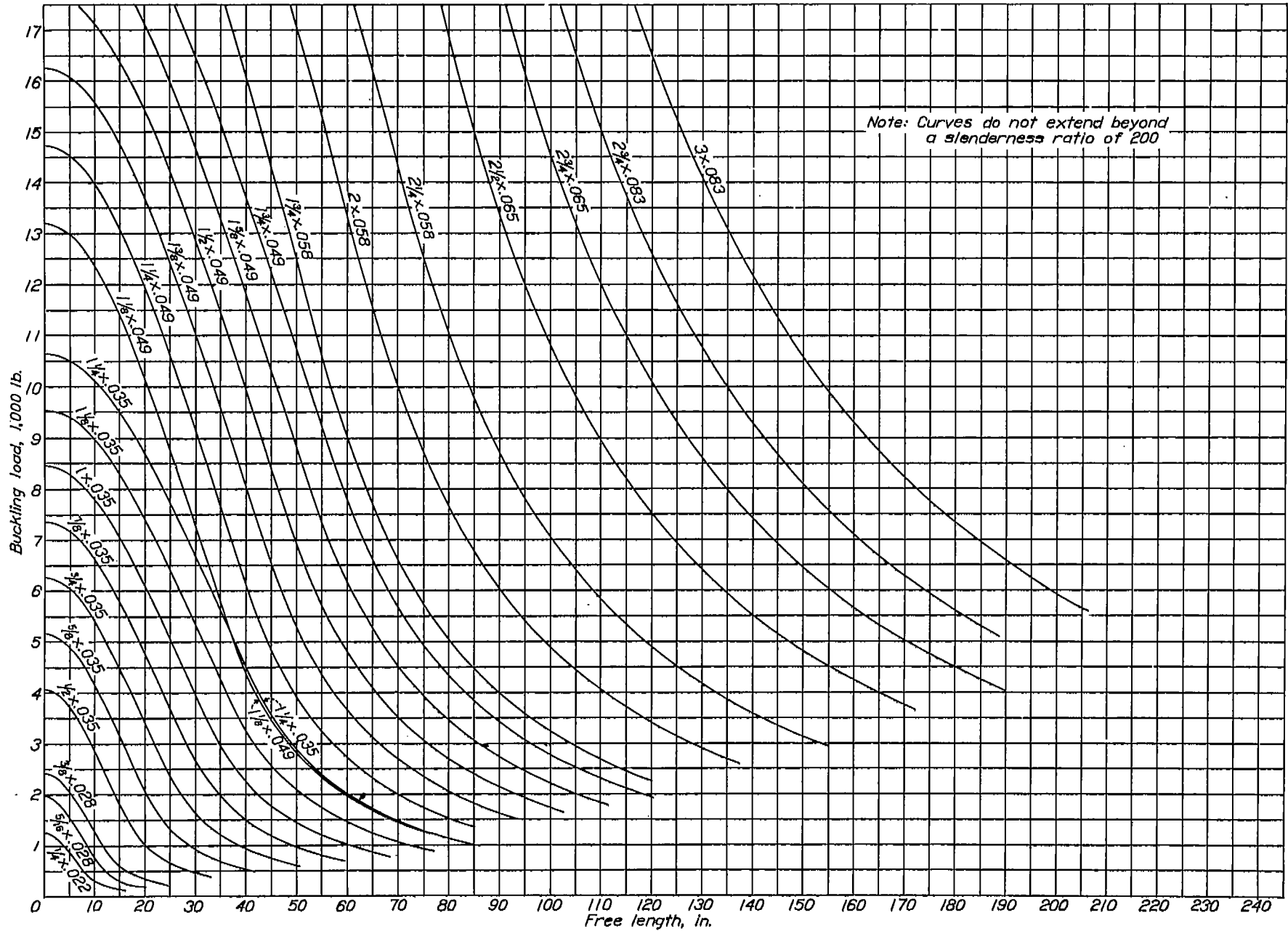
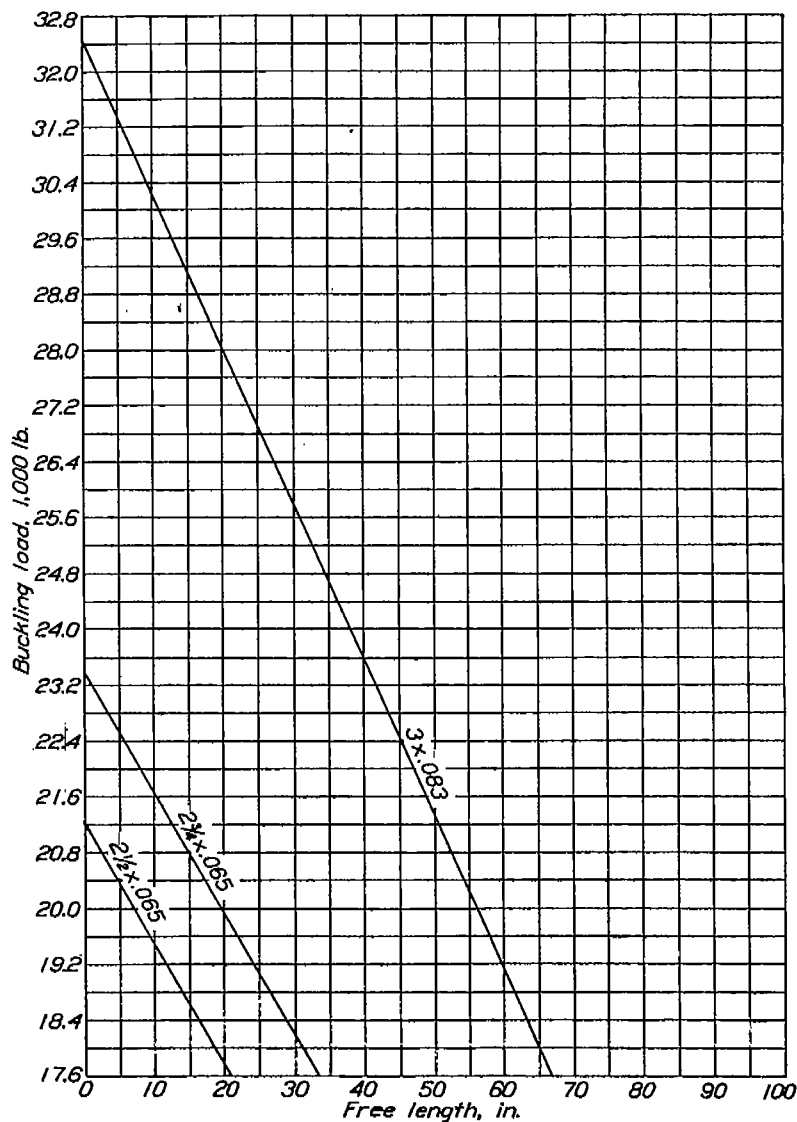
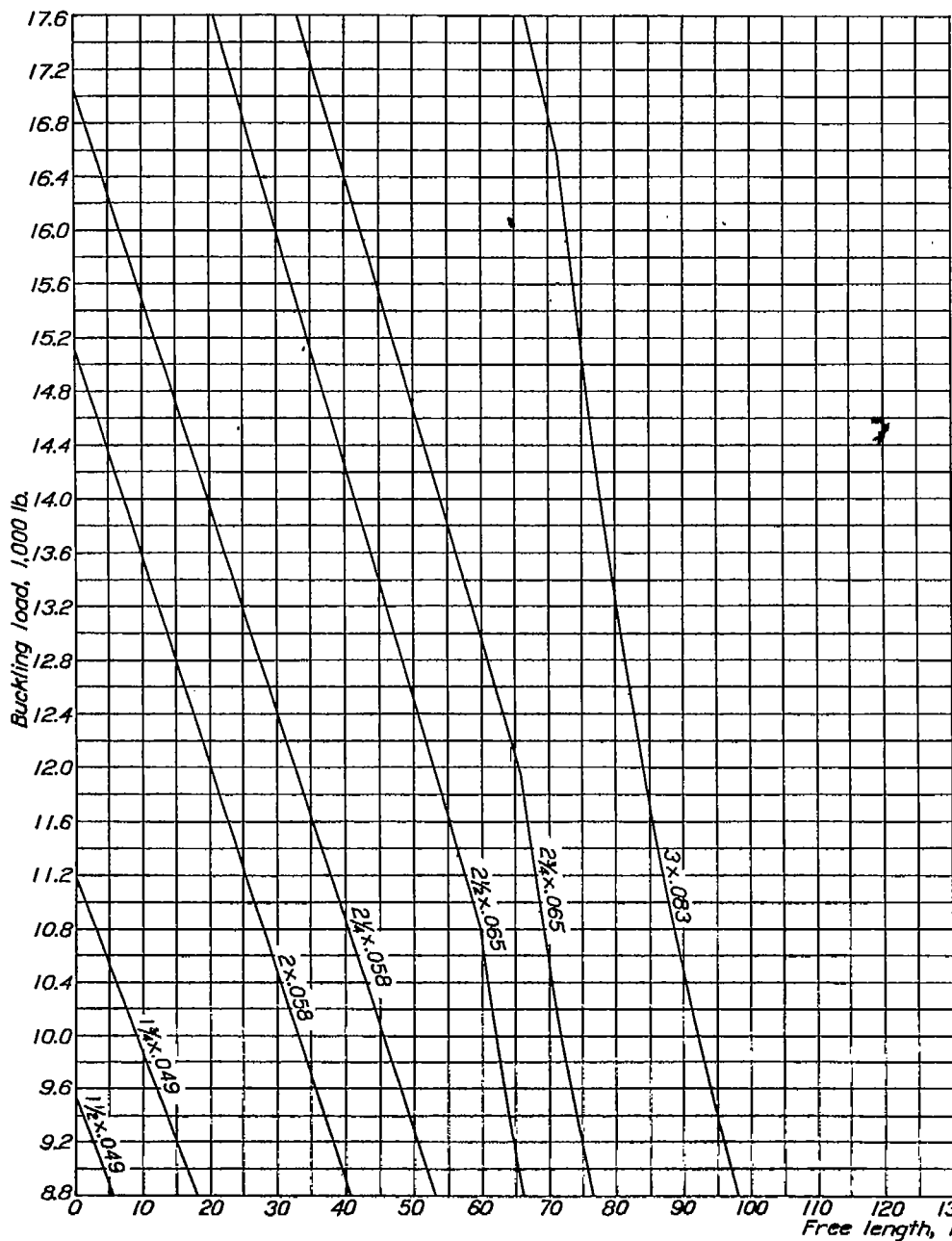

FIGURE 13.—The σ_c - P -diagram for Navy standard chromium-molybdenum-steel tubes.
 $Y, S = 75,000$ lb. per sq. in.
 $E = 29,800,000$ lb. per sq. in.



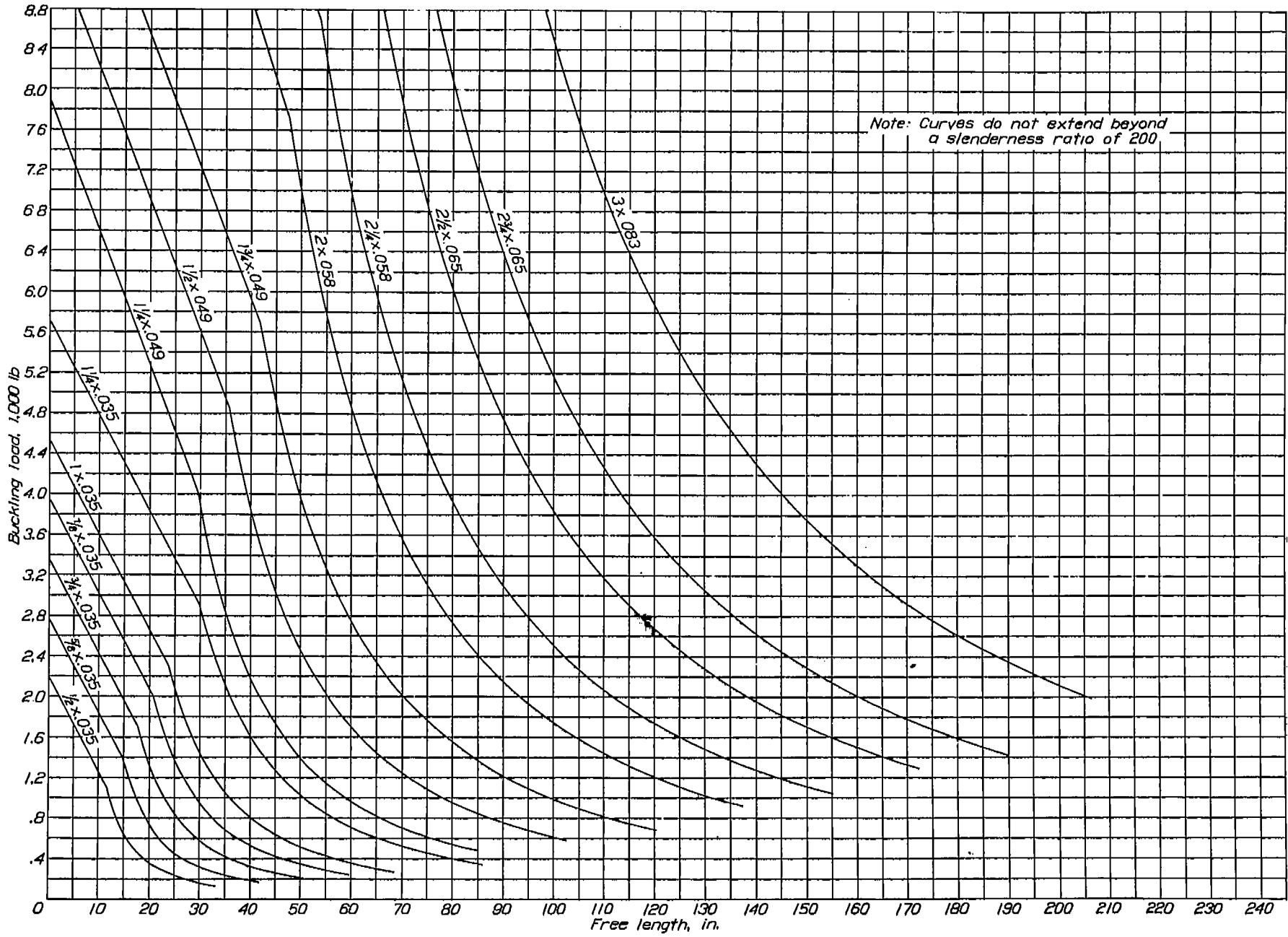
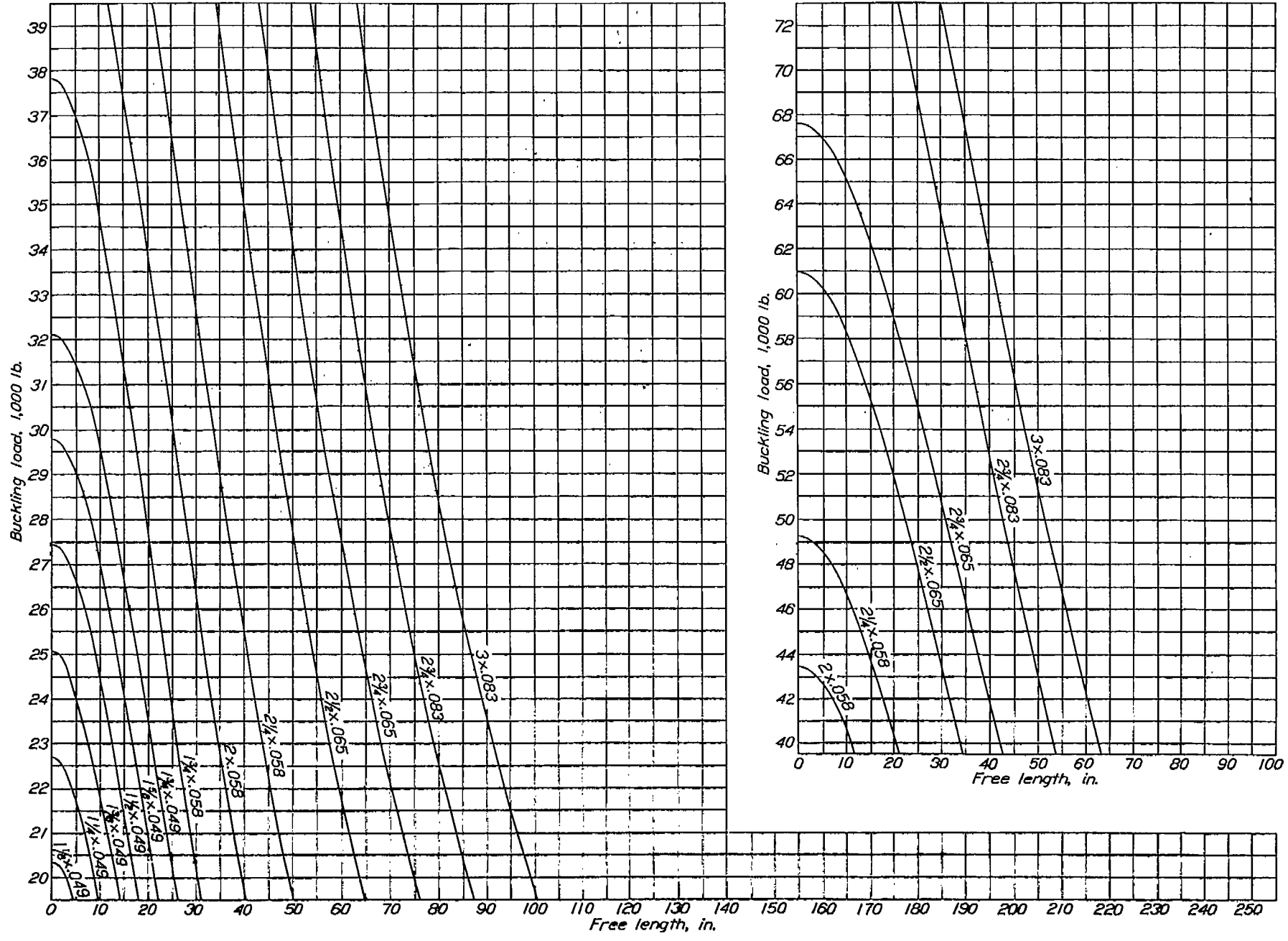

FIGURE 10.—The l, P —diagram for Navy standard duralumin tubes.
 $Y, S_1 = 40,000$ lb. per sq. in.
 $E = 10,590,000$ lb. per sq. in.



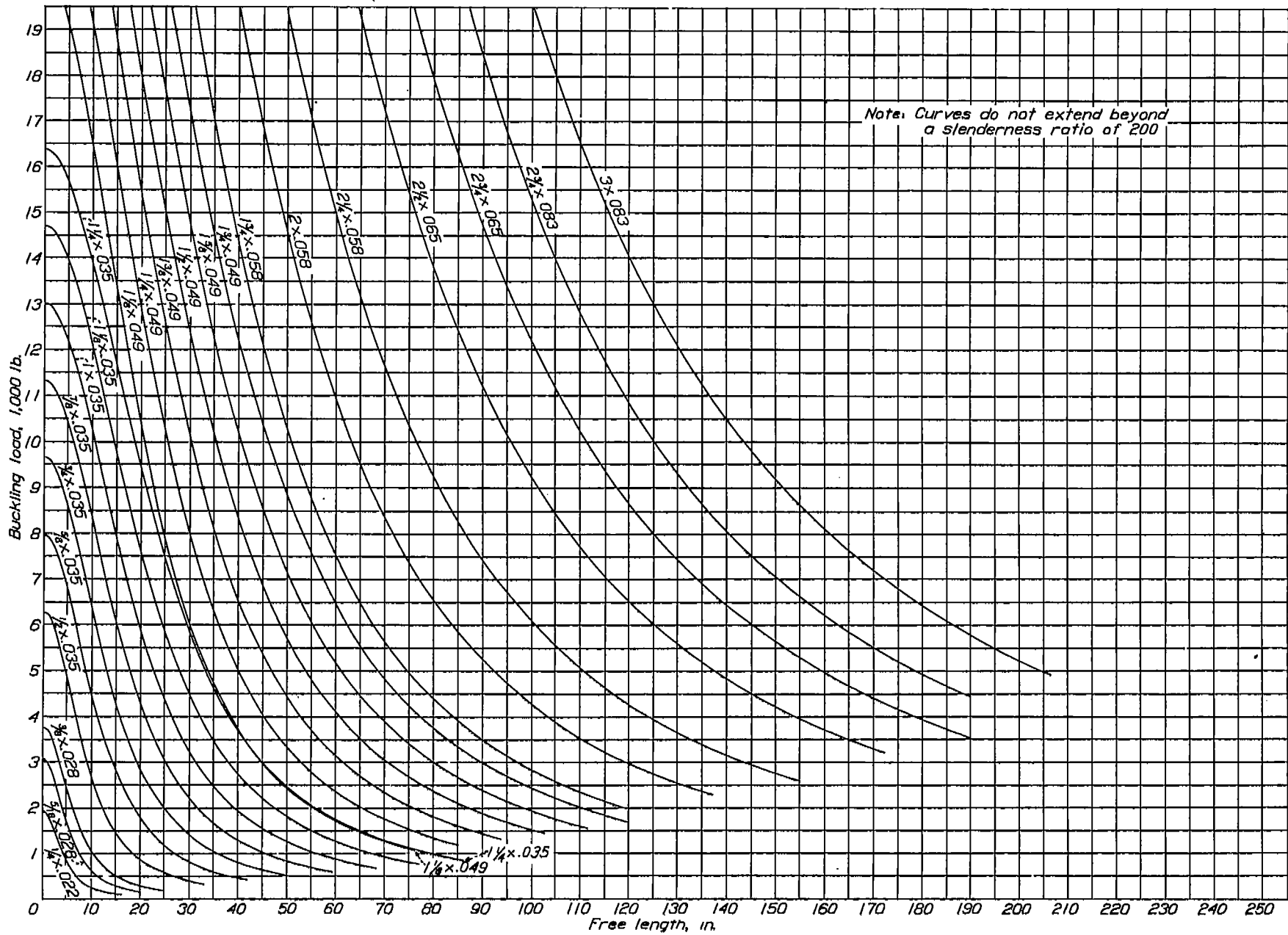
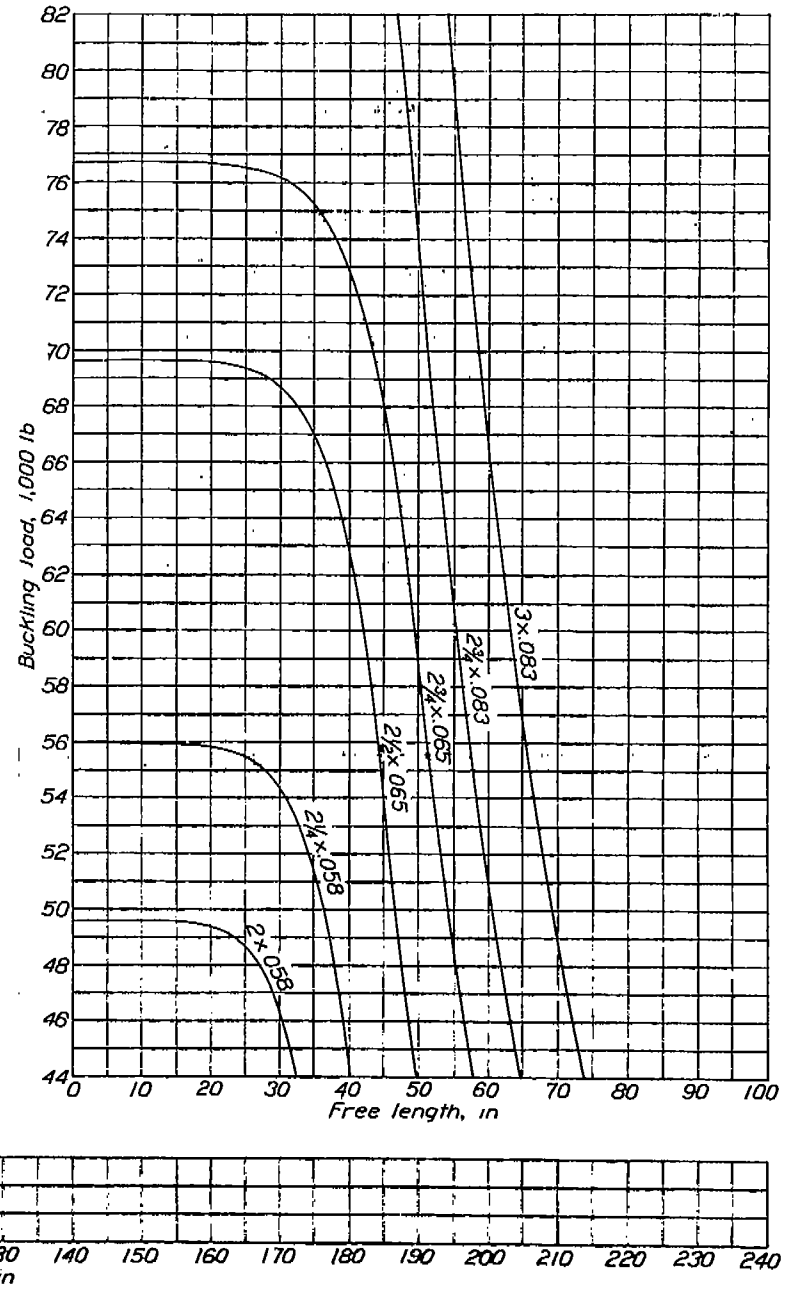
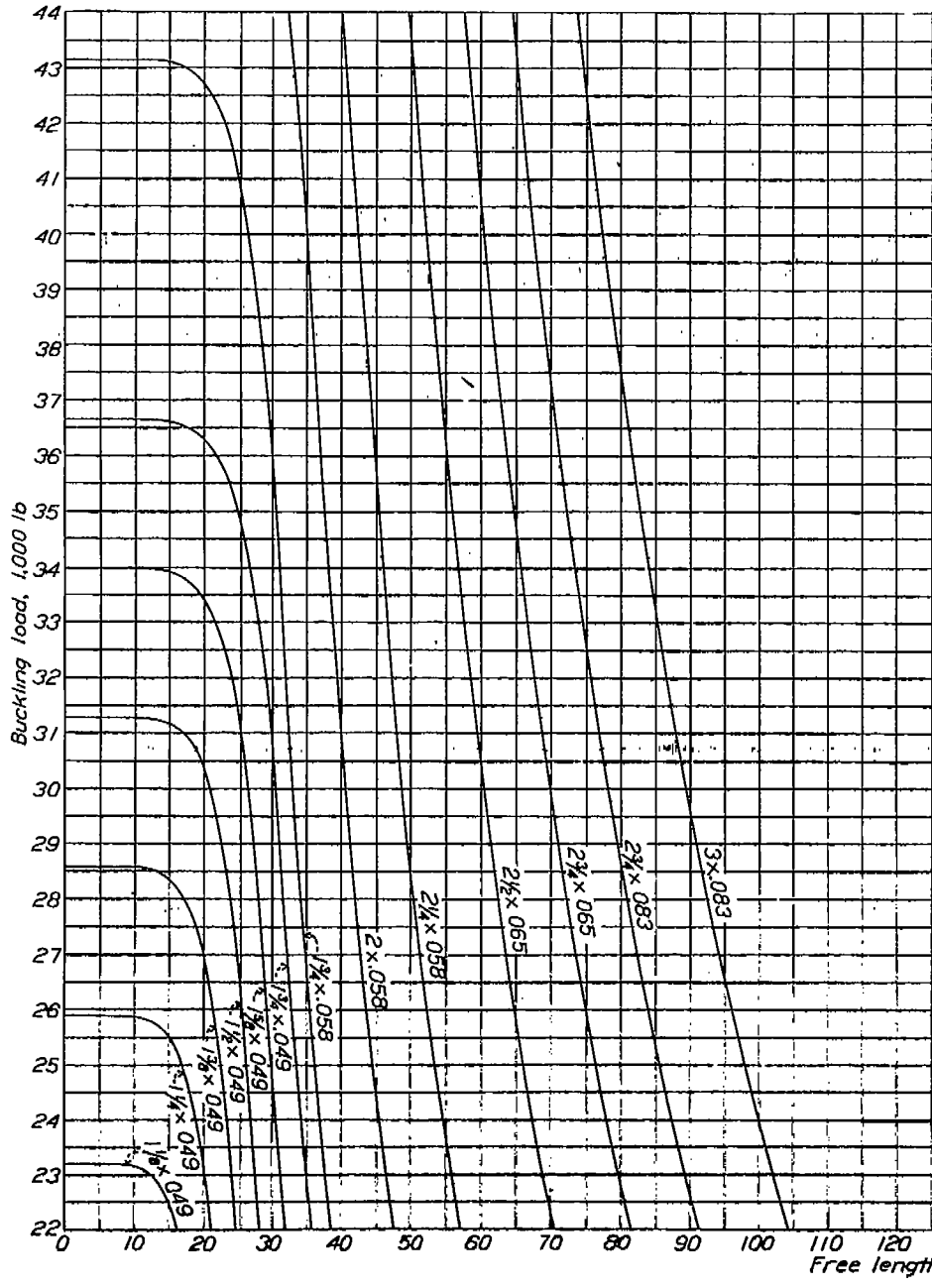

FIGURE 20.—The l, P —diagram for Navy standard stainless-steel tubes

$Y. S. = 135,000$ lb. per sq. in.
 $E = 26,300,000$ lb. per sq. in.



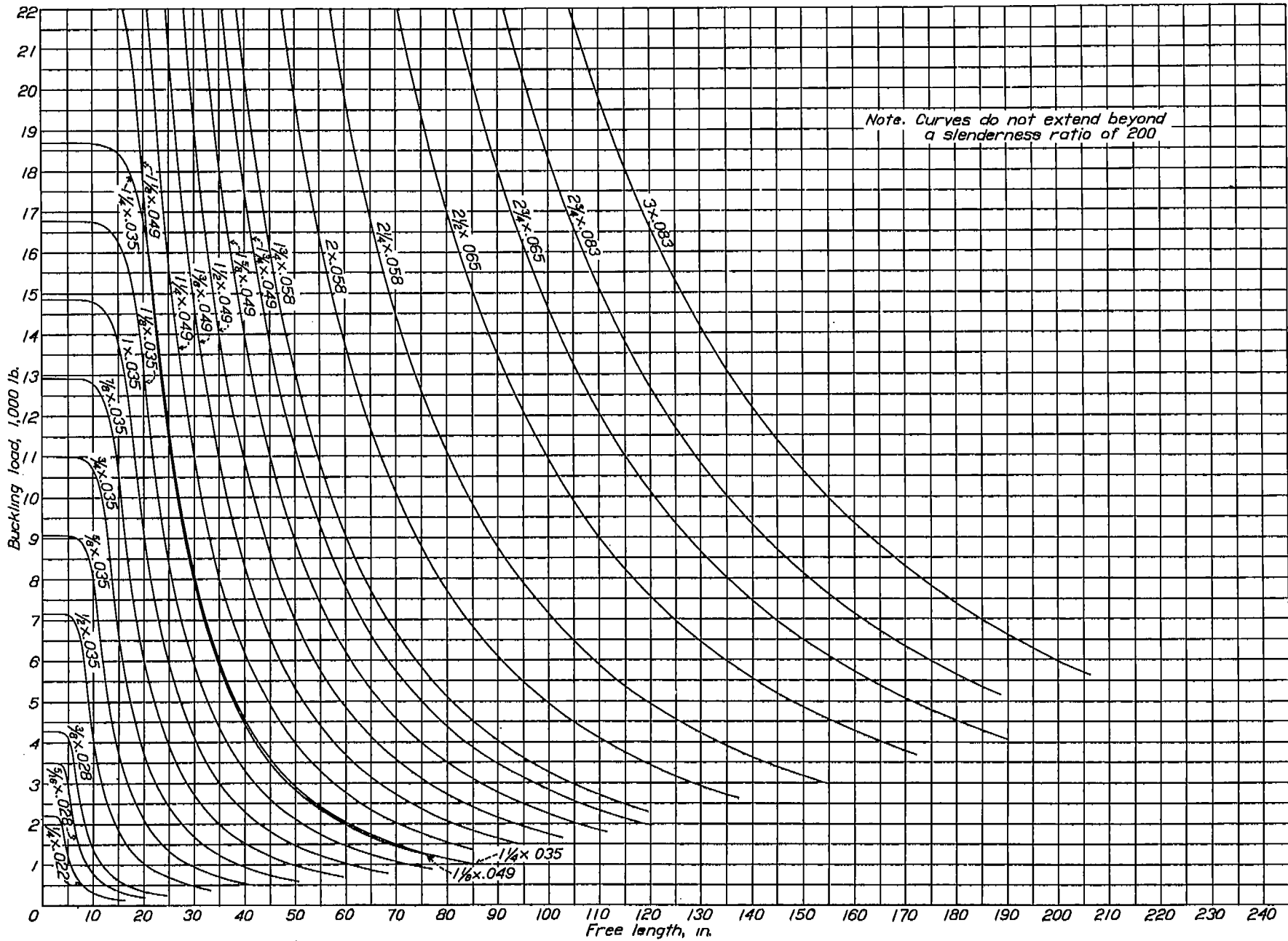

FIGURE 21.—The λ_c , P —diagram for heat-treated Navy standard chromium-molybdenum-steel tubes.
 $Y. S. = 160,000$ lb. per sq. in.
 $E = 30,000,000$ lb. per sq. in.

DISCUSSION

Figures 18, 19, 20, and 21 represent curves of buckling load P , plotted against free length, l_0 , for Navy Department standard sizes of tubing up to and including 3 inches in diameter. These curves were obtained from equations (21a) and (24b) by inserting the appropriate values of A and i and solving for P in terms of l_0 .

In the analysis of trusses continuous at the joints it is necessary to use the ratio $\tau = \bar{E}/E$, which is a function of the average stress on the cross section of a column at the instant of buckling, since \bar{E} is a function of this stress. The relation between τ and the average stress may be obtained by eliminating λ_{os} from equation (14) and the empirical equation applying for the particular material being used, and then substituting for σ_s its value in terms of P/A . Thus, for chromium-molybdenum steel, by eliminating λ_{os} from equations (16a) and (14) and substituting

$$\sigma_s = \frac{P}{1.000 \cdot 75000A} \left(\frac{P}{A} \text{ in lb. per sq. in.} \right)$$

$$\tau = 0.00007467 \frac{P}{A} \frac{1 - 0.00001260 \frac{P}{A}}{1 + 0.00001333 \frac{P}{A}} \text{ for } 79400 \geq \frac{P}{A} \geq 32600 \quad (25a)$$

$$\text{and from (16b) } \tau = 1, \text{ for } 32600 \geq \frac{P}{A} > 0. \quad (25b)$$

Similarly for duralumin, equations (17a) and (14) give on substituting $\sigma_s = \frac{P}{0.908 \cdot 40000A} \left(\frac{P}{A} \text{ in lb. per sq. in.} \right)$

$$\tau = 0.0001920 \frac{P}{A} \left(1 - 0.00002343 \frac{P}{A} \right)^2 \text{ for } 42700 \geq \frac{P}{A} \geq 21800, \quad (26a)$$

$$\text{and from (17b) } \tau = 1, \text{ for } 21800 \geq \frac{P}{A} > 0 \quad (26b)$$

And for stainless steel, equations (19) and (14) give on substituting $\sigma_s = \frac{P}{0.827 \cdot 135000A} \left(\frac{P}{A} \text{ in lb. per sq. in.} \right)$

$$\tau = \frac{17}{9} - \frac{8}{9} \sqrt{1 + \left(0.00001520 \frac{P}{A} \right)^2} \quad (27)$$

Finally, for heat-treated chromium-molybdenum steel, equations (20a) and (14) give, on substituting

$$\sigma_s = \frac{P}{0.99 \cdot 150000A} \left(\frac{P}{A} \text{ in lb. per sq. in.} \right)$$

$$\tau = 0.00001411 \frac{P}{A} \left(1 - \frac{P}{140000A} \right)^2 \text{ for } 140000 \geq \frac{P}{A} \geq 108900 \quad (28a)$$

$$\text{and from (20b)} \quad \tau = 1 \text{ for } 108900 \geq \frac{P}{A} > 0. \quad (28b)$$

Tables III, IV, V, and VI give values of τ for different values of P/A in equations (25a) to (28b). The quantity $\frac{1}{\pi} \sqrt{\frac{1}{E\tau}}$ is also listed in these tables as it will be found convenient to have it.

Some of the material used for test did not pass specifications in all particulars, and in the evaluation of the results of the tests, this matter should be considered. One failure to meet specifications which might be considered significant in the present investigation is the failure to reach the specified tensile yield strength, but this failure can be adequately corrected for by using the λ_{os} , σ_s -method of plotting, provided that enough specimens which do pass the specification for yield strength are also tested as checks. Two round column specimens did not pass the specification for straightness (maximum allowable departure from straightness: ratio of initial deflection to length 1 to 600), but these specimens showed no lower strength than other comparable specimens; nor was the effect of initial deflection on the strength apparent in any other case.

Occasional high points in the l_0/i , P/A - and λ_{os} , σ_s -diagrams, as in figures 8 and 9, and figures 12 and 13, were due to friction at the knife edges and have no practical significance. This friction was minimized in the later tests by vibrating the specimen slightly by means of a light buzzer attached to the middle of the specimen during test. Three conspicuously low points in figures 11 and 15 were due to failure by local buckling at the ends of the specimens where they bore on the plates of the carriers. Two of these specimens were from round tubes with ratios of diameter to thickness of 35.7 and 50.0, respectively, and the third was from a streamline tube with ratio of basic round diameter to thickness of 32.1.

It seems safe now to conclude that round tubes having ratios of diameter to thickness not greater than was mentioned previously and conforming to Navy Department Specifications 44T18c, 44T21b for heat-treated tubing or 44T27 (INT) for $\frac{1}{4}$ H-cold drawn tubing, in particular tubes having departures from straightness not much greater than allowed by the specifications, may be designed as columns with elastically restrained ends on the basis of the double modulus and equations (21a), (21b) for chromium-molybdenum steel; (22a), (22b) for duralumin; and (23) for stainless steel. Similarly, round heat-treated chromium-molybdenum-steel tubes with ratios of diameter to thickness not much greater than 35 and with tensile yield strengths not less than 150,000 lb. per sq. in. may be designed with the aid of equations (24a) and (24b).

As far as the shape of the cross section is concerned, theoretically the streamline tubes should be slightly weaker than the round tubes; but this difference would be so small as to be masked by other considerations in a series of tests made under necessarily practical conditions. If the difference did show itself, it should do so independently of the material; but no such consistent difference appears in the test results.

The points representing the chromium-molybdenum-steel streamline tubing in the λ_{os}, σ_s -diagram (fig. 12) are all low except one, but these low values are believed to be due to the appreciably flatter knee of the compressive stress-strain diagram (reference 22) of the material of the streamline tubes. (See 1CB-C in fig. 1.) If this particularly flat knee may also be expected in round chromium-molybdenum-steel tubing, further tests with round tubing having this characteristic would be desirable. The results available indicate that for streamline chromium-molybdenum-steel tubing not over 0.186 inch thick, passing Navy Department Specification 44T17b, for which the ratio of basic round diameter d to thickness t does not appreciably exceed 35 (see table I), formula (21a) may be replaced by

$$\frac{P}{A} = 82400 \frac{20000 - \left(\frac{l_0}{i}\right)^2}{18900 + \left(\frac{l_0}{i}\right)^2} \text{ for } 87200 \geq \frac{P}{A} \geq 35800$$

For values of P/A less than 35,800 lb. per sq. in., equation (21b) applies.

The points representing the duralumin streamline tubing in the λ_{os}, σ_s -diagram (fig. 13) all except one high one closely follow the points for the round tubing.

The points representing the stainless-steel streamline tubing in the λ_{os}, σ_s -diagram (fig. 14) are the most erratic of any for the four materials tested, but this fact is not altogether surprising since the material was not the same as that of the round stainless-steel tubes. The trend of the points for the streamline tubing relative to those for the round tubing is consistent with the differences shown by the compressive stress-strain diagrams. The stress-strain curves of the material of the streamline tubing had sharper knees than those of the material of the round tubes (see 2SC-C in fig. 3) and the streamline-column specimens show high values of σ_s for high values of λ_{os} and low values of σ_s for low values of λ_{os} , which would be expected (reference 22).

The points representing the heat-treated chromium-molybdenum-steel tubing (fig. 15) closely follow the points for the round tubing, except two which are the results of tests on specimens with restrained ends. The restraint was heavy, 440,000 lb.-in. per radian and the reduced load-deflection curves for these specimens were not smooth at low loads and showed very blunt "knees." It is probable that, as load was applied, the movable head of the testing machine did not move parallel to itself, thus producing a rotation of the top end of the specimen and bending, which resulted in a very nonuniform distribution of stress. Since the knee of the stress-strain curve of this material is so sharp, premature bending of the specimen would lower the column strength more pronouncedly than would be the case with a material with a blunt knee.

NOTE ON THE DESIGN OF COMPRESSION MEMBERS ELASTICALLY RESTRAINED AT THE ENDS

In a truss or a framework (*Stabnetz*) continuous at the joints the members are interdependent, and in particular the buckling strength of a member depends on the restraining moments (positive or negative) produced at its ends by the other members meeting there. These moments, moreover, depend on the geometrical and material properties of all the members of the truss or framework. It is not possible, therefore, to consider the buckling of a compression member by itself but only as part of the structure as a whole. Theoretically, it is possible to determine with given conditions of loading the maximum load to produce failure of any truss, but practically, the solution of the transcendental equations involved is out of the question except for the simplest cases. Approximate solutions based on simplifying assumptions at present seem to offer the only way out.

Only planar trusses with the joints assumed to be immovable will be considered here. The case of movable joints has been treated by Bleich (reference 9), Prager (reference 23), and others; the case of space structures has been treated notably by Friedrich and Hans Bleich (reference 24).

In order to get anywhere it is necessary to assume that the truss can be broken up into sufficiently simple groups of members to enable the stability of each group to be investigated separately. Two such groups are (a) an individual compression member and the members meeting it at its ends, the far ends of the latter members being considered as freely supported (fig. 22); and (b) three members forming a triangle (fig. 23). As will be shown presently by examples, the first group can be treated by means of equation (12), and the stability of the second group can be investigated by means of the condition of buckling of a triangle.

$$\begin{vmatrix} t'_{ij} + t'_{jk} & s'_{jk} & s'_{ij} \\ s'_{jk} & t'_{jk} + t'_{ki} & s'_{ki} \\ s'_{ij} & s'_{ki} & t'_{ki} + t'_{ij} \end{vmatrix} = 0 \quad (25)$$

where

$$s' = \frac{E}{Pl} s \text{ and } t' = \frac{E}{Pl} t$$

and the subscripts refer to the members as shown in figure 23. This equation is given as applying to the elastic case by Borkmann (reference 25) and may be derived by applying the equation of four moments, Bleich (reference 9), successively to the members ij , jk ; jk , ki ; and ki , ij .

In the groups of members the stability of which is to be considered, P for each member represents the load in the member, positive for compression and negative for tension. The quantity ϕ , which occurs in the expressions for s and t , is always given by

$$\phi = l \sqrt{\frac{|P|}{EI}} \quad (26)$$

but when P is negative (tension), s and t become

$$s = \frac{\phi}{\sinh \phi} - 1 \text{ and } t = 1 - \frac{\phi}{\tanh \phi} \quad (9a)$$

If a member carries no load, or is assumed to carry no load, an assumption which may be made for sim-

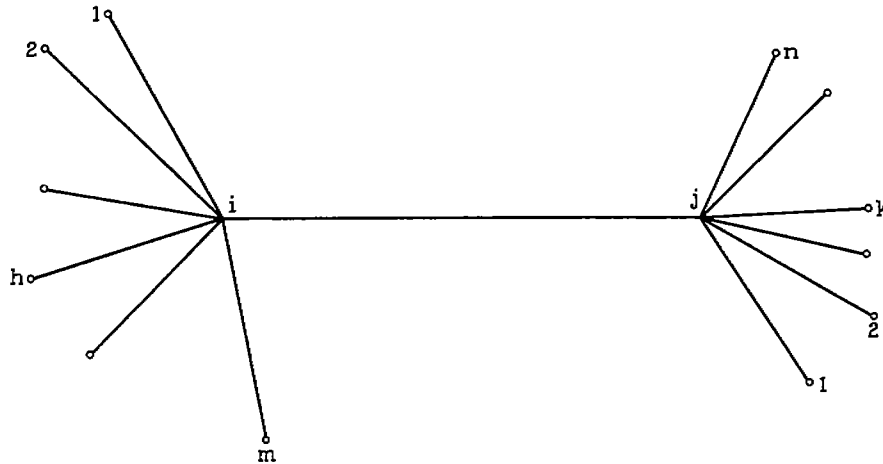

FIGURE 22.—A member of a truss, together with the members meeting it at its ends.

Similarly for any member meeting ij at j

$$\mu_{jk} = \frac{m_{jk}}{P_{jk}l_{jk}} = -\frac{1}{t_{jk}}$$

Now since

$$m_1 + m_{11} + m_{12} + \dots + m_{1n} + \dots + m_{1m} = 0$$

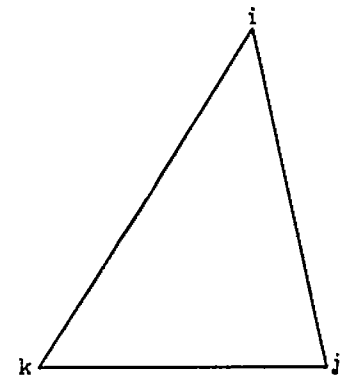

FIGURE 23.—Three members of a truss forming a triangle.

plicity and with safety for most practical tension members (see the appendix) then s' and t' or $s/(Pl)$ and $t/(Pl)$ become indeterminate. These quantities may be evaluated by the usual methods, and one finds

$$\frac{s}{Pl} = \frac{l}{6EI} \text{ and } \frac{t}{Pl} = \frac{l}{3EI} \quad (9b)$$

Equation (12) applied to the group of members shown in figure 22 may be written

$$\mu_1 \mu_j (t_{1j}^2 - s_{1j}^2) + (\mu_1 + \mu_j) t_{1j} + 1 = 0 \quad (27)$$

and

$$m_1 + m_{11} + m_{12} + \dots + m_{1k} + \dots + m_{1m} = 0,$$

there can be obtained by simple substitution¹⁵

$$\left. \begin{aligned} \mu_1 &= \frac{1}{P_{1j}l_{1j}} \left(\frac{P_{11}l_{11}}{t_{11}} + \frac{P_{12}l_{12}}{t_{12}} + \dots + \frac{P_{1m}l_{1m}}{t_{1m}} \right) \\ \mu_j &= \frac{1}{P_{j1}l_{j1}} \left(\frac{P_{j1}l_{j1}}{t_{j1}} + \frac{P_{j2}l_{j2}}{t_{j2}} + \dots + \frac{P_{jn}l_{jn}}{t_{jn}} \right) \end{aligned} \right\} \quad (28)$$

The method of treating such groups of members as those designated (a) and (b) depends on whether it is

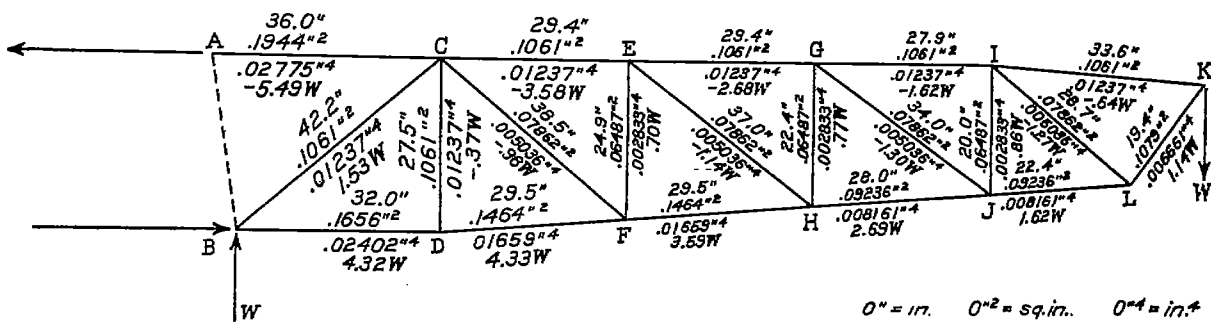

FIGURE 24.—Portion of a fuselage.

where μ_i and μ_j are the values of μ at i and j , respectively, and it is necessary to determine μ_i and μ_j in terms of the loads and the dimensions of the members of the group. The quantities μ_i and μ_j depend on the restraints offered by the members meeting ij at i and at j and may be found easily by applying equation (12) to these members. Thus if the member hi is considered and the value of μ at h is put equal to $\mu_{hi} = 0$, since the member is supposed freely supported at h , there is obtained on solving for the value of μ at i for this member

$$\mu_{ih} = \frac{m_{ih}}{P_{ih}l_{ih}} = -\frac{1}{t_{ih}}$$

desired merely to check the stability of existing groups under given loads or whether the groups are to be designed to carry specific loads. The actual procedure may be much the same in the two cases. In the first case the left-hand side of equation (27) or (25) is computed, whichever one applies, and is compared with the right-hand side, 0. No simple criteria can be given for assuring stability by means of such a comparison, however, and it is recommended that for a group like that shown in figure 22 the nomogram, figure 7, be used in conjunction with equation (27) to

¹⁵ The expressions for μ_i and μ_j were differently determined in reference 15 and were there called T_i and T_j .

determine whether a member is stable. It should be noted that no value of $\phi/\pi > 1.4303$ must be allowed to occur in any member *ih* or *jk*, because $\phi/\pi = 1.4303$ represents the condition of one end freely supported and the other end fixed. For a triangular group (fig. 23), care must be exercised in using equation (25) that no values of ϕ/π occur larger than those which correspond to the lowest critical loading. In the second case, that of designing members for specific loads, equation (27) or (25) must be solved for one unknown, ϕ , if the other members are assumed to be known, or if more than one member is unknown, the equation that applies must be solved by trial for such a combination of ϕ 's as will satisfy it. A numerical example will help to clarify the procedure.

Example: Figure 24 shows in outline a portion of a loaded chromium-molybdenum-steel truss. Posted on each member is its length *l*, cross-sectional area *A*, cross-sectional moment of inertia *I*, and load *P*. By a consideration of the group of members *FE*, *FC*, *FD*, *FH*, *HJ*, *HG*, and *HE*, it has been found that this group just reaches a neutral state of equilibrium when *W* = 1,450 pounds. It is desired to check the other compression members in order to determine whether they are in stable equilibrium and possibly to redesign some of them. Only two groups will be considered here, the group (a) *JL*, *JG*, *JL*, *LK*, *LI* and the group (b) *BC*, *CD*, and *DB*. It is convenient to arrange at least part of the computation in some such tabular form as the following:

1 Member	2 (In.)	3 <i>A</i> (sq. in.)	4 <i>I</i> (in. ⁴)	5 <i>P</i> (lb.)	6 $\frac{P}{A}$ (lb. per sq. in.)	7 $\frac{10^4}{\pi} \sqrt{\frac{I}{E_r}}$ (in./lb. ^{1/2})	8 $\sqrt{\frac{P}{I}}$ (lb. ^{1/2} /in. ²)	9 $\frac{\phi}{\pi}$	10 <i>s</i>	11 <i>t</i>	12 <i>t</i> — <i>s</i>	13 $\frac{10^4}{P^2}$ (1/lb.-in.)	14 $\frac{10^4 s}{P^2}$ (1/lb.-in.)	15 $\frac{P^2}{10^4 t}$ (lb.-in.)
JL	20.0	0.06487	0.002833	1,247	19,220	0.0583	663.5	0.774		3.831		0.4010		6.510
JG	34.0	.07862	.005036	0	0	.0583	0	0		0		∞		13.24
JL	22.4	.09236	.008161	2,349	25,490	.0583	536.5	.701		2.611	3.829	.01900		20.16
LK	19.4	.1079	.006661	1,653	16,320	.0583	498.2	.563		1.365		.03113		23.67
LI	28.7	.07862	.005036	0	0	.0583	0	0		0		∞		15.69
BC	42.2	.1061	.01237	2,218	20,910	.0583	423.4	1.042	-28.07	-23.86	-110.6	.01063	-0.2784	-3.925
CD	27.5	.1061	.01237	-636	-5,062	.0583	208.2	.334	-1623	-3424	.0909	-.06784	.01101	43.05
DB	32.0	.1656	.02402	6,264	37,830	.0583	510.7	.963	25.66	27.38	95.73	.00499	.1275	7.321

The values of *P* in the table are obtained from figure 24 with *W* = 1,450 pounds; the values in column 7 are obtained from table III; those in column 9 are 1 one-thousandth of the product of those in Columns 2, 7, and 8; those in columns 10, 11, and 12 are obtained from table VII except for member *CD*; and the source of the other entries is obvious. It was assumed for simplicity, and to be on the safe side, that members *JG* and *LI* carried no stress.

If equation (27) is now applied to the group (a), there is first obtained from equation (2)

$$\mu_J = 0.01900 (6.510 + 13.24) = 0.3752$$

$$\mu_L = 0.01900 (23.67 + 15.69) = 0.7478$$

Now substitute into equation (27) and find $0.3752 \times 0.7477 \times 3.829 + (0.3752 + 0.7478) \times 2.611 + 1 > 0$. The group is safe. The design, however, may be uneconomical and the possibility of redesigning the member *JL* is investigated. Any of the other members or any two or more members might have been considered. Substitute μ_J and μ_L as just found into equation (27) and solve it for ϕ_{JL} by trial with the aid of table VII or, more simply, determine ϕ_{JL} directly from the nomogram of figure 7:

$$\frac{\phi_{JL}}{\pi} = 1.784$$

This is the value of ϕ/π required for the member *JL* in order to bring the group (a) into neutral equilibrium. The value of ϕ/π in the original design is only 0.701, so that a considerably smaller member *JL* would be adequate. Assuming tubular construction, such a

member may be picked from the chart of figure 18 by entering it at the load $P_{JL} = 2,349$ lb. and the free length, computed from equation (4)

$$l_0 = \frac{l_{JL}}{\frac{\phi_{JL}}{\pi}} = \frac{22.4}{1.784} = 12.56 \text{ in.}$$

It is found that a 1/2-in. by 0.035-in. tube would be satisfactory. Whether this tube would represent a practical possibility is, of course, another matter.

If some member of the group other than the member *JL* were to be redesigned, equation (27) with the expressions for μ from equation (28) could be solved directly for the value of *t* required for the member. The required value of ϕ/π could then be looked up in table VII in the case of a compression member, or computed from equation (9a) in the case of a tension member. A new compression member could then be picked from figure 18 as just explained. A new tension member would have to be chosen by satisfying equation (26) by trial. If more than one member of the group were to be redesigned, a relation connecting the various ϕ/π 's could be obtained from equations (27) and (28) and this relation satisfied by trial. It would probably be at least as expeditious, however, to modify one member at a time rather than two or more simultaneously.

Let the second group of members now be considered—the triangle composed of the members *BC*, *CD*, *DB*. Proceed in the same general way as with the first group, that is, compare the left-hand side of equation (25) with zero. If the determinant is expanded, the values of *s*' and *t*' in terms of *E*, *P*, *l*, *s*, and *t* are substituted,

and the result is divided through by E^3 , there may be written

$$\begin{aligned} & \left(\frac{t_{BC}}{P_{BC}l_{BC}} + \frac{t_{CD}}{P_{CD}l_{CD}} \right) \left(\frac{t_{CD}}{P_{CD}l_{CD}} + \frac{t_{DB}}{P_{DB}l_{DB}} \right) \left(\frac{t_{DB}}{P_{DB}l_{DB}} + \frac{t_{BC}}{P_{BC}l_{BC}} \right) \\ & + 2 \frac{s_{BC}s_{CD}s_{DB}}{P_{BC}l_{BC}P_{CD}l_{CD}P_{DB}l_{DB}} \frac{s_{BC}^2}{P_{BC}^2l_{BC}^2} \left(\frac{t_{CD}}{P_{CD}l_{CD}} + \frac{t_{DB}}{P_{DB}l_{DB}} \right) \\ & - \frac{s_{CD}^2}{P_{CD}^2l_{CD}^2} \left(\frac{t_{DB}}{P_{DB}l_{DB}} + \frac{t_{BC}}{P_{BC}l_{BC}} \right) \\ & - \frac{s_{DB}^2}{P_{DB}^2l_{DB}^2} \left(\frac{t_{BC}}{P_{BC}l_{BC}} + \frac{t_{CD}}{P_{CD}l_{CD}} \right) = 0 \end{aligned} \quad (29)$$

Substitution from the table gives

$$0.004375 - 0.0007816 - 0.01239 + 0.00001433 + 0.003766 = -0.005017 < 0.$$

The group is safe. The design may be uneconomical, however, and the possibility of redesigning the member BC is investigated. Any of the other members or any two of them might have been considered. For the present purpose it is more convenient to write equation (29) in the form

$$\begin{aligned} & \frac{1}{P_{BC}^2l_{BC}^2} \left(\frac{t_{CD}}{P_{CD}l_{CD}} + \frac{t_{DB}}{P_{DB}l_{DB}} \right) (t_{BC}^2 - s_{BC}^2) \\ & + \frac{1}{P_{BC}l_{BC}} \left[\left(\frac{t_{CD}}{P_{CD}l_{CD}} + \frac{t_{DB}}{P_{DB}l_{DB}} \right)^2 - \left(\frac{s_{CD}^2}{P_{CD}^2l_{CD}^2} + \frac{s_{DB}^2}{P_{DB}^2l_{DB}^2} \right) \right] t_{BC} \\ & + 2 \frac{s_{CD}s_{DB}s_{BC}}{P_{CD}l_{CD}P_{DB}l_{DB}P_{BC}l_{BC}} + \frac{(t_{DB}^2 - s_{DB}^2)t_{CD}}{P_{DB}^2l_{DB}^2P_{CD}l_{CD}} \\ & + \frac{(t_{CD}^2 - s_{CD}^2)t_{DB}}{P_{CD}^2l_{CD}^2P_{DB}l_{DB}} = 0 \end{aligned}$$

Substitution from the table of all values except s_{BC} and t_{BC} gives after simplification

$$t_{BC}^2 - s_{BC}^2 + 5.366t_{BC} + 1.645s_{BC} + 6.194 = 0$$

Solution of this equation by trial with the aid of table VII gives for the value of ϕ/π required to cause buckling,

$$\frac{\phi_{BC}}{\pi} = 1.799$$

Since this value is greater than the actual value, 1.043, a smaller member may be picked from figure 18. If, as before, the free length is determined

$$l_0 = \frac{l_{BC}}{\frac{\phi_{BC}}{\pi}} = 23.46 \text{ in.}$$

and the chart (fig. 18) entered with this length and the load $P_{BC} = 2,218 \text{ lb.}$, a $\frac{3}{8}$ -in. by 0.035-in. tube is found to be adequate.

It may be noted that when for any member ϕ/π is less than unity, the member has reserve strength considered as a freely supported column and can act to restrain the members meeting at its ends. In the previous example, the values of ϕ/π for all the members were less than unity except for the member BC. No value of ϕ/π greater than 2 is possible if the structure is to remain stable.

It may happen that the most severe condition of loading for a given member is not the one that produces the greatest average compressive stress in the member. Strictly, then, every member should be investigated for each condition of loading which produces compression in it. Practically, however, this procedure will not be necessary, and if a member in compression is satisfactory for the condition of loading producing the greatest average compressive stress in it, it will usually be possible to tell by inspection whether other conditions of loading should also be considered.

NATIONAL BUREAU OF STANDARDS,
Washington, D. C., September 9, 1937.

APPENDIX

The simplifying assumption that tension members in a group carry no load is safe so long as the quantities $\frac{Pl}{s}$ and $\frac{Pl}{t}$ which occur for these members satisfy the conditions

$$\frac{Pl}{s} = \frac{-|Pl|}{\frac{\phi}{\sinh \phi} - 1} \geq \frac{6EI}{l} \quad (a)$$

and

$$\frac{Pl}{t} = \frac{-|Pl|}{1 - \frac{\phi}{\tanh \phi}} \geq \frac{3EI}{l} \quad (b)$$

respectively. In order to investigate whether these conditions are satisfied in any given case, it is necessary to know the value of τ for computing ϕ . Since no information concerning τ will usually be available for tension members, it is suggested that the values given for the same stress in compression be used. It is not to be expected that the discrepancy will be large. For $\tau=1$ conditions (a) and (b) will always be satisfied, and for any practical member it is almost certain that

they will be. In case of doubt, for example, extremely high values of $|P|/A$, the simplifying assumption should not be made.

REFERENCES

1. Tuckerman, L. B.: Discussion of paper by R. L. Templin, The Determination and Significance of the Proportional Limit in the Testing of Metals. Proc. Am. Soc. Testing Mats., vol. 29, pt. II, 1929, pp. 538-546.
2. Osgood, William R.: The Double-Modulus Theory of Column Action. Civil Engineering, vol. 5, no. 3, March 1925, pp. 173-175.
3. Christie, James: Experiments on the Strength of Wrought-Iron Struts. Trans. Am. Soc. Civ. Eng., vol. 13, April 1884, p. 85.
4. Considère, A.: Résistance des Pièces Comprimées. Congrès International des Procédés de Construction, 1891, p. 371.
5. Engesser, Fr.: Über die Knickfestigkeit von Stäben veränderlichen Trägheitsmomentes. Zeit. d. Österreich. Ing.- u. Arch.-Vereines, vol. 61, 1909, p. 544.
6. Nater, H.: Knickung elastisch eingespannter Stäbe. Schweizerische Bauzeitung, Bd. 71, 18. Mai 1918, S. 215.
7. Usinger, P.: Beiträge zur Knicktheorie. Der Eisenbau, Bd. 9, Aug. 1918, S. 169.

8. Leduc, R.: Contribution à l'Étude des Poutres Prismatiques. Services Techniques de l'Aéronautique, Bulletin Technique No. 60, Juin 1929, p. 43.
9. Bleich, Fr.: Theorie und Berechnung der eisernen Brücken. Julius Springer (Berlin), 1924; also Die Knickfestigkeit elastischer Stabverbindungen. Der Eisenbau, Bd. 10, Feb. 1919, S. 27.
10. von Kármán, Th.: Untersuchungen über Knickfestigkeit, Mitteilungen über Forschungsarbeiten. Ver. deutsch. Ing., Heft 81, 1910.
11. Zimmermann, H.: Die Knickfestigkeit von Stäben mit nicht gerader Achse. Sitzungsberichte der Preussischen Akademie der Wissenschaften, 18. Oktober 1923, S. 262; also Lehre vom Knicken auf neuer Grundlage, Wilhelm Ernst und Sohn (Berlin), 1930.
12. Rein, W.: Versuche zur Ermittlung der Knickspannungen für verschiedene Baustähle. Julius Springer (Berlin), 1930.
13. Zimmermann, H.: Knickfestigkeit der Stabverbindungen. Wilhelm Ernst und Sohn (Berlin), 1925.
14. Prager, W.: The Buckling of an Elastically Encastred Strut. Jour. R. A. S., vol. 49, no. 311, Nov. 1936, pp. 833-834.
15. Osgood, Wm. R.: Contribution to the Design of Compression Members in Aircraft. Bur. Standards Jour. Res., vol. 13, no. 1, July 1934, pp. 157-160.
16. Soreau, Rodolphe: Nomographie ou Traité des Abaques. Tome I, Etienne Chiron (Paris), 1921, p. 172.
17. Hohenemser, K.: Fließversuche an Rohren aus Stahl bei kombinierter Zug- und Torsionsbeanspruchung. Z. A. M. M., Bd. 11, Feb. 1931, S. 15.
18. Tuckerman, L. B., Petrenko, S. N., and Johnson, C. D.: Strength of Tubing under Combined Axial and Transverse Loading. T. N. No. 307, N. A. C. A., 1929.
19. Domke, O.: Die Ausbiegung eines Druckstabes bei Überschreitung der Knicklast. Die Bautechnik, Bd. 4, 26. Nov. 1926, S. 747.
20. Kreüger, H.: Bidrag till frågen om stråfvors knäckning. Teknisk Tidskrift (Sweden), Väg- och Vattenbyggnadskonst., vol. 45, Sept. 15, 1915, p. 101.
21. Aarflot, M. G.: A New Column Formula. Bul. Am. Soc. Swedish Eng., vol. 26, Feb. 1931, p. 7.
22. Osgood, William R.: Column Curves and Stress-Strain Diagrams. Research Paper No. 492, Bur. Standards Jour. Res., vol. 9, no. 4, Oct. 1932, pp. 571-582.
23. Prager, W.: Elastic Stability of Plane Frameworks. Jour. Aero. Sci., vol. 3, no. 11, Sept. 1936, p. 388.
24. Bleich, Friedrich, und Bleich, Hans: Die Stabilität räumlicher Stabverbindungen. Zeit. d. Österreich. Ing.- u. Arch.-Vereines, Bd. 80, 1928, S. 345.
25. Borkmann, K.: Charts for Checking the Stability of Compression Members in Trusses. T. M. No. 800, N. A. C. A., 1936.

TABLE I.—NOMINAL DIMENSIONS OF TUBES AND RESTRAINTS USED

Nominal diameter or basic round diameter <i>d</i> (in.)	Nominal thickness <i>t</i> (in.)	Nominal <i>d/t</i>	Nominal area <i>A</i> (sq. in.)	Radius of gyration <i>i</i> (in.)	Restraints ¹
ROUND TUBES					
Chromium-molybdenum steel					
1-----	0.035	28.6	0.1061	0.3414	<i>A</i> <i>CHab</i>
1½-----	.049	23.0	.1558	.3808	<i>A</i> <i>CHab</i>
2-----	.058	25.9	.2628	.5102	<i>A</i> <i>BDEGab</i>
Duralumin					
1-----	0.035	28.6	0.1061	0.3414	<i>A</i> <i>CH</i>
1½-----	.058	25.9	.2628	.5102	<i>A</i> <i>CHab</i>
2-----	.058	34.5	.3539	.6369	<i>A</i> <i>CH</i>
Stainless steel					
1-----	0.035	28.6	0.1061	0.3414	<i>A</i> <i>Gab</i>
1½-----	.083	12.0	.2391	.3255	<i>A</i> <i>CGa</i>
1½-----	.085	35.7	.1336	.4297	<i>A</i> <i>Cb</i>
1½-----	.065	19.2	.2420	.4186	<i>A</i> <i>Ga</i>
1½-----	.049	30.6	.2234	.5133	<i>A</i> <i>C'</i>
Heat-treated chromium-molybdenum steel					
1-----	0.042	22.8	0.1264	0.3390	<i>A</i>
1½-----	.035	35.7	.1336	.4297	<i>A</i> <i>F</i>
1½-----	.035	50.0	.1586	.6065	<i>A</i>
1½-----	.049	35.7	.2618	.6016	<i>A</i>
STREAMLINE TUBES					
Chromium-molybdenum steel					
1½-----	0.035	35.7	0.1336	0.2509	<i>A</i> <i>F</i>
2¼-----	.083	30.1	.6302	.4963	<i>A</i>
Duralumin					
1½-----	0.035	35.7	0.1336	0.2509	<i>A</i> <i>F</i>
2¼-----	.035	38.6	.4972	.5167	<i>A</i>
Stainless steel					
1½-----	0.035	35.7	0.1336	0.2509	<i>A</i> <i>F</i>
1½-----	.049	30.6	.2234	.2997	<i>A</i> <i>F</i>
2-----	.053	34.5	.3539	.4122	<i>A</i>
2¼-----	.065	38.6	.4972	.5167	<i>A</i>
Heat-treated chromium-molybdenum steel					
1½-----	0.035	32.1	0.1198	0.2251	<i>A</i> <i>F</i>
2¼-----	.038	38.8	.3994	.4527	<i>A</i> <i>F</i>

¹ Restraints are designated in lb.-in. per radian as follows: equal restraints at both ends, *A*=0; *B*=132,000; *C*=233,000; *D*=250,000; *E*=330,000; *F*=440,000; *G*=451,000; *H*=452,000; restraint at lower end only, *a*=233,000; *b*=450,000.

TABLE II.—RESULTS OF TESTS ON COLUMNS

ROUND TUBING

BOTH ENDS FREELY SUPPORTED OR RESTRAINED

Specimen	End restraint $10^{-3}m$ (lb.-in. per radian)	Ratio of slender- ness l/t	Average stress F/A (lb. per sq. in.)	$\lambda_c = \frac{l}{\pi} \sqrt{\frac{S}{E}}$	$\sigma_c = \frac{P}{AS}$	Specimen	End restraint $10^{-3}m$ (lb.-in. per radian)	Ratio of slender- ness l/t	Average stress F/A (lb. per sq. in.)	$\lambda_c = \frac{l}{\pi} \sqrt{\frac{S}{E}}$	$\sigma_c = \frac{P}{AS}$
CHROMIUM-MOLYBDENUM STEEL											
1 in. diameter by 0.031 in. thick. Nominal $d/t=28.6$											
CA-4	233	22.27	90,910	0.408	0.917	CA-5	0	59.85	66,080	1.092	0.667
CA-5b	233	43.65	79,730	.797	.805	CA-2	452	78.08	44,080	1.425	0.445
1 1/4 in. diameter by 0.049 in. thick. Nominal $d/t=23.0$											
DA-3	233	41.34	77,960	0.728	0.845	DA-2	452	70.29	50,530	1.237	0.548
DA-5	0	49.78	73,190	.876	.793	DA-4	0	89.85	35,830	1.582	.383
DA-5c	0	67.79	65,780	1.193	.604						
1 1/4 in. diameter by 0.033 in. thick. Nominal $d/t=25.9$											
D-6	451	19.07	87,420	0.334	0.964	AD-2	250	65.52	52,200	1.100	0.644
O-3	230	19.77	86,470	.339	1.004	N-3	330	64.30	59,930	1.108	.623
A-6	451	19.08	90,250	.339	.972	AC-2	451	71.08	51,120	1.120	.626
D-3	330	19.81	84,880	.343	.936	Q-3	330	64.12	62,960	1.127	.623
O-6	250	20.57	82,090	.352	.959	X-3	250	68.05	56,800	1.174	.614
AK-2	230	21.08	92,650	.375	.991	AF-2	451	72.90	54,650	1.224	.646
A-3	132	26.42	85,380	.499	.920	AB-2	250	76.99	42,400	1.271	.629
B-3	132	26.45	86,610	.472	.928	N-2	330	74.70	46,780	1.285	.541
T-2	451	30.57	81,540	.529	.928	Q-2	330	76.29	51,700	1.324	.565
AJ-2	451	30.75	87,890	.535	.969	P-3	0	76.59	49,870	1.329	.545
O-2	330	32.45	82,280	.555	.958	I-3	0	76.66	49,300	1.336	.514
D-2	330	32.16	80,950	.563	.933	F-3	132	78.28	45,510	1.363	.617
L-5	0	32.82	83,430	.579	.920	S-2	250	77.99	44,500	1.367	.491
P-5	0	32.96	86,240	.579	.942	I-3	132	78.69	46,210	1.379	.618
V-3	250	34.84	85,020	.607	.961	V-2	451	84.65	40,640	1.474	.454
Z-3	250	34.99	88,470	.613	.980	Z-2	451	84.32	39,920	1.477	.442
A-2	132	44.38	80,020	.738	.809	R-2	330	87.25	35,390	1.483	.410
O-5	451	46.19	76,340	.790	.887	J-2	330	87.77	37,130	1.499	.433
B-2	132	44.93	82,870	.801	.888	I-2	132	88.37	34,670	1.548	.357
U-3	451	47.00	82,980	.833	.891	F-2	132	89.55	35,970	1.590	.409
R-3	330	48.91	74,730	.834	.879	T-5	250	91.23	33,680	1.580	.383
J-3	330	48.89	75,910	.835	.885	U-2	250	91.70	32,700	1.626	.361
P-4	0	51.21	72,300	.900	.790	E-3	0	100.3	28,830	1.741	.323
L-4	0	51.27	74,750	.905	.824	M-3	0	100.4	29,040	1.756	.321
D-5	250	52.55	72,190	.920	.796	H-2	132	102.5	27,780	1.781	.317
A-5	250	53.49	77,600	.950	.836	G-2	132	102.7	26,390	1.795	.295
AI-2	451	60.13	57,300	.956	.720	P-2	0	120.3	20,360	2.114	.222
AH-2	451	60.39	64,000	1.061	.703	K-2	0	120.2	20,720	2.160	.219
H-3	132	62.60	62,750	1.083	.716	E-4	0	150.0	16,330	2.604	.183
G-3	132	62.85	59,820	1.098	.668	M-2	0	150.2	13,110	2.643	.145
DURALUMIN											
1 in. diameter by 0.035 in. thick. Nominal $d/t=28.6$											
EA-4	233	21.84	43,600	0.436	1.041	EA-5b	0	65.34	24,380	1.304	0.582
EA-3	233	41.95	33,220	.837	.795	EA-2	452	76.44	16,330	1.525	.391
EA-5a	0	59.74	27,050	1.192	.647	EA-5d	0	85.29	14,310	1.702	.342
EA-6	0	59.84	27,690	1.194	.662	EA-5e	0	85.32	14,280	1.702	.342
EA-5c	0	65.23	24,930	1.301	.596						
1 1/4 in. diameter by 0.058 in. thick. Nominal $d/t=25.9$											
BD-2b	0	24.46	38,240	0.478	0.958	BC-6	0	49.94	31,410	1.008	0.746
BA-6	0	29.94	37,670	.597	.968	BA-5	0	74.82	18,780	1.492	.453
BB-7	0	29.97	37,410	.595	.966	BC-4	0	74.97	18,700	1.510	.444
BB-5	452	32.75	36,620	.653	.887	BA-3	0	98.88	10,740	1.991	.259
BC-5	233	34.27	35,730	.690	.849	BB-3	0	98.88	11,370	1.992	.275
BD-2	0	39.57	32,840	.780	.823	BB-2	0	118.4	7,520	2.361	.182
BD-2a	0	39.89	32,910	.780	.825	BC-3	0	118.6	7,400	2.389	.176
BA-4	452	45.97	30,720	.916	.740	BA-2	0	147.7	4,810	2.918	.117
BB-4	233	48.78	31,180	.973	.755	BC-2	0	147.9	8,800	2.980	.209
BB-6	0	49.90	30,850	.995	.747						
2 in. diameter by 0.058 in. thick. Nominal $d/t=34.5$											
FA-3	452	41.38	32,990	0.819	0.801	FA-5	0	49.93	29,920	0.983	0.726
FA-4	233	45.36	30,840	.898	.749	FA-2	452	58.02	26,900	1.148	0.630
STAINLESS STEEL											
1 in. diameter by 0.035 in. thick. Nominal $d/t=28.6$											
GA-7	451	25.22	124,400	0.541	1.034	GB-6	0	60.43	59,870	1.292	0.501
GA-9	0	35.52	87,180	.762	.724	GA-6	0	80.31	56,400	1.294	.468
GB-10	0	35.64	93,250	.762	.780	GA-5	0	78.76	40,350	1.582	.355
GB-8	0	50.35	69,180	1.077	.678	GA-3	0	97.90	28,280	2.094	.218
GA-8	0	50.22	63,410	1.077	.627	GA-2	0	126.0	19,470	2.702	.137
GB-2	451	59.12	69,510	1.264	.498						

TABLE II.—RESULTS OF TESTS ON COLUMNS—Continued

Specimen	End restraint 10 ⁻³ m (lb.-in. per radian)	Ratio of slender- ness l/i	Average stress P/A (lb. per sq. in.)	$\lambda_{cr} = \frac{1}{\pi} \frac{l_0}{r} \sqrt{\frac{S}{E}}$	$\frac{\sigma_c}{A}$	Specimen	End restraint 10 ⁻³ m (lb.-in. per radian)	Ratio of slender- ness l/i	Average stress P/A (lb. per sq. in.)	$\lambda_{cr} = \frac{1}{\pi} \frac{l_0}{r} \sqrt{\frac{S}{E}}$	$\frac{\sigma_c}{AS}$
STAINLESS STEEL—Continued											
1 in. diameter by 0.063 in. thick. Nominal d/t=12.0											
HB-7	233	30.02	111,200	0.626	0.974	HB-8	0	63.38	80,080	1.322	0.439
HB-9	0	37.37	88,680	.779	.777	HB-5	0	77.46	39,150	1.616	.343
HB-4	451	48.34	70,680	1.008	.619	HB-3	0	102.4	22,530	2.136	.206
HB-8	0	52.82	61,520	1.102	.589	HB-2	0	132.2	14,890	2.756	.130
1 1/4 in. diameter by 0.035 in. thick. Nominal d/t=35.7											
IG-10	0	29.61	119,800	0.720	0.798	IG-9	0	40.33	97,800	0.981	0.649
IG-5	233	39.25	97,180	.955	.648	IG-8	0	45.02	83,080	1.095	.564
1 1/4 in. diameter by 0.065 in. thick. Nominal d/t=19.2											
JB-9	451	15.89	146,800	0.333	1.311	JB-8	0	78.18	35,650	1.640	0.318
JB-10	0	38.71	80,120	.812	.716	JB-6	0	102.6	22,760	2.168	.212
1 1/4 in. diameter by 0.049 in. thick. Nominal d/t=30.6											
KB-8	233	18.12	143,100	0.389	1.178	KB-7	0	75.52	38,310	1.622	0.315
KB-9	0	37.92	89,710	.814	.738						
HEAT-TREATED CHROMIUM-MOLYBDENUM STEEL											
1 in. diameter by 0.042 in. thick. Nominal d/t=23.8											
IHZ-2	0	24.50	168,800	0.604	0.939	IHZ-6	0	49.10	122,900	1.207	0.692
IHZ-38	0	25.51	168,100	.653	.936	IHZ-7	0	52.16	85,320	1.455	.477
IHZ-1	0	24.00	164,900	.588	.917	IHZ-4	0	64.74	72,780	1.692	.407
IHZ-5	0	39.95	163,300	.932	.940	IHZ-3	0	94.76	29,860	2.455	.167
1 1/4 in. diameter by 0.035 in. thick. Nominal d/t=35.7											
2HY-1	440	12.07	191,300	0.304	1.020	IHY-7	0	52.95	107,800	1.326	0.590
2HY-2	440	18.44	188,900	.465	.996	IHY-8	0	55.92	96,760	1.400	.521
IHY-9	0	20.93	*162,200	.624	.819	IHY-3	0	64.75	71,280	1.621	.383
IHY-6	0	40.08	166,600	1.004	.848	IHY-4	0	79.82	47,250	1.999	.254
IHY-59	0	43.15	164,300	1.081	.830	IHY-5	0	129.6	17,740	3.245	.095
IHY-2	0	47.37	127,500	1.186	.686						
1 1/4 in. diameter by 0.035 in. thick. Nominal d/t=50.0											
IHX-1	0	19.37	*150,200			IHX-2	0	129.8	17,530		
IHX-23	0	45.25	140,800			Values of S could not be obtained.					
1 1/4 in. diameter by 0.049 in. thick. Nominal d/t=35.7											
IHW-1	0	33.02	170,700	0.818	0.980	IHW-2	0	79.78	46,810	1.977	0.256
IHW-35	0	38.09	164,700	.946	.907	IHW-3	0	96.77	31,660	2.402	.175
IHW-34	0	42.18	167,100	1.046	.863						
LOWER END RESTRAINED											
CHROMIUM-MOLYBDENUM STEEL											
1 in. diameter by 0.035 in. thick. Nominal d/t=28.6											
CA-5c	450	46.90	76,880	0.856	0.776	CA-5d	233	48.06	77,920	0.877	0.786
1 1/4 in. diameter by 0.049 in. thick. Nominal d/t=23.0											
DA-5a	450	52.68	63,900	0.927	0.692	DA-5b	233	55.60	66,910	0.979	0.726
1 1/4 in. diameter by 0.058 in. thick. Nominal d/t=25.9											
AA-2	450	58.56	66,180	0.994	0.763	AA-2a	233	63.07	62,950	1.071	0.737
DURALUMIN											
1 1/4 in. diameter by 0.058 in. thick. Nominal d/t=25.9											
BD-3	450	38.07	24,330	0.745	0.861	BD-4	233	39.24	38,610	0.767	0.842

TABLE II.—RESULTS OF TESTS ON COLUMNS—Continued

STAINLESS STEEL

Specimen	End re- straint $10^{-4}m$ (lb.-in. per radian)	Ratio of slender- ness l/t	Average stress P/A (lb. per sq. in.)	$\lambda_{cr} = \frac{1}{\pi} \sqrt{\frac{l^2}{E}}$	$\sigma_c = \frac{P}{AS}$	Specimen	End re- straint $10^{-4}m$ (lb.-in. per radian)	Ratio of slender- ness l/t	Average stress P/A (lb. per sq. in.)	$\lambda_{cr} = \frac{1}{\pi} \sqrt{\frac{l^2}{E}}$	$\sigma_c = \frac{P}{AS}$
1 in. diameter by 0.035 in. thick. Nominal $d/t=28.6$											
GA-10.....	450	21.17	132,800	0.454	1.103	GB-4.....	450	65.92	52,930	1.410	0.443
GB-5.....	238	50.13	68,820	1.072	.575						
1 in. diameter by 0.063 in. thick. Nominal $d/t=12.0$											
HB-10.....	238	24.67	119,000	0.515	1.042						
$1\frac{1}{4}$ in. diameter by 0.035 in. thick. Nominal $d/t=35.7$											
IG-6.....	450	54.26	71,850	1.320	0.479						
$1\frac{1}{4}$ in. diameter by 0.065 in. thick. Nominal $d/t=19.3$											
JB-5.....	238	75.84	39,040	1.591	0.349						

STREAMLINE TUBING ^b

BOTH ENDS FREELY SUPPORTED OR RESTRAINED

CHROMIUM-MOLYBDENUM STEEL

1.685 by 0.714 by 0.035 in. Nominal $d/t=35.7$

ICB-4a.....	0	35.65	77040	0.630	0.839	ICB-2.....	0	59.37	60690	1.049	0.641
ICB-1.....	0	39.81	73530	.790	.801	ICB-3.....	0	79.51	39500	1.405	.430
ICB-4b.....	440	44.91	70930	.794	.773						

3.372 by 1.429 by 0.083 in. Nominal $d/t=30.1$

ICA-1.....	0	58.80	65070	0.993	0.760	ICA-3.....	0	79.74	43670	1.346	0.512
------------	---	-------	-------	-------	-------	------------	---	-------	-------	-------	-------

DURALUMIN

1.685 by 0.714 by 0.035 in. Nominal $d/t=35.7$

IDB-1.....	0	39.97	29560	0.722	0.854	IDB-2.....	0	59.80	24030	1.030	0.625
IDB-4a.....	440	46.25	27320	.836	.790	IDB-3.....	0	79.08	17130	1.445	.495

3.372 by 1.429 by 0.065 in. Nominal $d/t=38.5$

IDC-2.....	0	39.24	28550	0.706	0.844	IDC-3.....	0	79.70	17350	1.434	0.497
IDC-1.....	0	59.14	26040	1.064	.744						

STAINLESS STEEL

1.685 by 0.714 by 0.035 in. Nominal $d/t=35.7$

ISB-2a.....	440	42.48	86100	0.860	0.793	ISB-1.....	0	99.05	27510	2.006	0.253
-------------	-----	-------	-------	-------	-------	------------	---	-------	-------	-------	-------

2.028 by 0.857 by 0.049 in. Nominal $d/t=30.6$

ISD-2.....	440	53.90	67910	1.181	0.502	ISD-1.....	0	80.16	41360	1.757	0.306
------------	-----	-------	-------	-------	-------	------------	---	-------	-------	-------	-------

2.097 by 1.143 by 0.053 in. Nominal $d/t=34.5$

ISF-2a.....	0	23.65	110300	0.493	0.837						
-------------	---	-------	--------	-------	-------	--	--	--	--	--	--

3.372 by 1.429 by 0.065 in. Nominal $d/t=38.5$

2SC-1.....	0	59.32	64460	1.168	0.535						
------------	---	-------	-------	-------	-------	--	--	--	--	--	--

HEAT-TREATED CHROMIUM-MOLYBDENUM STEEL

1.517 by 0.643 by 0.035 in. Nominal $d/t=32.1$

IHG-3c.....	440	35.00	* 149200	0.841	0.865	IHG-1.....	0	93.09	75780	1.515	0.439
IHG-3a.....	0	40.48	147400	.971	.855	IHG-2.....	0	79.34	47790	1.906	.277
IHG-3.....	440	41.48	141800	.965	.822						

3.035 by 1.286 by 0.053 in. Nominal $d/t=38.8$

IHE-3.....	440	47.55	115900	1.181	0.662	IHE-2.....	0	65.43	72550	1.537	0.418
IHE-1.....	0	49.77	125100	1.184	.715						

* Local failure.

^b Sizes are given by major diameter, minor diameter, and thickness. Nominal d/t is given for basic round diameter.

TABLE III.—VALUES OF τ AND $\frac{1}{\pi} \sqrt{\frac{I}{Er}}$ FOR CHROMIUM-MOLYBDENUM STEEL

$E=29,800,000$ lb. per sq. in.

P/A (lb. per sq. in.)	τ	Δ	$\frac{10^4}{\pi} \sqrt{\frac{I}{Er}}$ (in./lb. ^{1/2})	Δ	P/A (lb. per sq. in.)	τ	Δ	$\frac{10^4}{\pi} \sqrt{\frac{I}{Er}}$ (in./lb. ^{1/2})	Δ	P/A (lb. per sq. in.)	τ	Δ	$\frac{10^4}{\pi} \sqrt{\frac{I}{Er}}$ (in./lb. ^{1/2})	Δ
0 to 32,600	1	0	0.0553	0	49,000	0.847		0.0633	7	65,000	.471	29	0.0850	28
33,000	1.000	1	.0583	0	50,000	.829	18	.0640	8	66,000	.442	30	.0878	31
34,000	.999	1	.0583	0	51,000	.810	19	.0648	8	67,000	.412	30	.0909	35
35,000	.996	3	.0584	1	52,000	.791	19	.0656	8	68,000	.382	30	.0944	41
36,000	.992	4	.0585	1	53,000	.771	20	.0664	8	69,000	.351	31	.0985	47
37,000	.987	5	.0587	2	54,000	.749	22	.0674	10	70,000	.319	32	.1032	56
38,000	.981	6	.0589	2	55,000	.727	22	.0684	10	71,000	.287	32	.1088	68
39,000	.974	7	.0591	2	56,000	.705	23	.0694	10	72,000	.255	32	.1156	83
40,000	.966	8	.0593	2	57,000	.682	23	.0706	12	73,000	.222	33	.1239	106
41,000	.956	10	.0596	3	58,000	.658	24	.0719	13	74,000	.188	34	.1345	141
42,000	.946	10	.0599	3	59,000	.633	25	.0733	14	75,000	.154	34	.1456	201
43,000	.935	11	.0603	4	60,000	.607	26	.0748	15	76,000	.120	34	.1687	313
44,000	.922	13	.0607	4	61,000	.581	26	.0765	17	77,000	.085	35	.2005	626
45,000	.909	13	.0612	5	62,000	.555	26	.0783	18	78,000	.049	36	.2531	2441
46,000	.895	14	.0617	5	63,000	.527	28	.0803	20	79,000	.013	36	.5072	∞
47,000	.880	15	.0622	5	64,000	.499	28	.0825	22	79,400	0	13	∞	∞
48,000	.864	16	.0627	5			28		25					
49,000		17		6										

TABLE IV.—VALUES OF τ AND $\frac{1}{\pi} \sqrt{\frac{I}{Er}}$ FOR DURALUMIN

$E=10,500,000$ lb. per sq. in.

P/A (lb. per sq. in.)	τ	Δ	$\frac{10^4}{\pi} \sqrt{\frac{I}{Er}}$ (in./lb. ^{1/2})	Δ	P/A (lb. per sq. in.)	τ	Δ	$\frac{10^4}{\pi} \sqrt{\frac{I}{Er}}$ (in./lb. ^{1/2})	Δ	P/A (lb. per sq. in.)	τ	Δ	$\frac{10^4}{\pi} \sqrt{\frac{I}{Er}}$ (in./lb. ^{1/2})	Δ
0 to 21,800	1	0	0.0978	4	29,000	0.572		0.1294	37	36,000	0.169	22	0.238	17
22,000	.991	26	.0982	14	29,500	.540	32	.1331	41	36,500	.147	21	.255	21
22,500	.965	26	.0996	14	30,000	.508	31	.1372	45	37,000	.126	20	.276	25
23,000	.939	28	.1010	15	30,500	.477	32	.1417	49	37,500	.106	18	.301	30
23,500	.911	29	.1025	16	31,000	.445	30	.1466	53	38,000	.088	17	.331	37
24,000	.882	29	.1041	18	31,500	.415	31	.1519	59	38,500	.071	15	.368	47
24,500	.853	30	.1059	19	32,000	.384	29	.1578	6	39,000	.056	14	.415	62
25,000	.823	30	.1078	20	32,500	.355	29	.164	7	39,500	.042	12	.477	86
25,500	.793	31	.1098	22	33,000	.326	29	.171	8	40,000	.030	10	.563	125
26,000	.762	31	.1120	24	33,500	.297	27	.179	9	40,500	.020	8	.688	200
26,500	.731	32	.1144	26	34,000	.270	27	.188	10	41,000	.012	6	.858	370
27,000	.699	31	.1170	27	34,500	.243	26	.198	12	41,500	.006	4	1.258	917
27,500	.668	32	.1197	30	35,000	.217	24	.210	13	42,000	.002	2	2.175	6129
28,000	.636	32	.1227	32		.193	24	.223	15	42,500	.000	0	8.304	∞
28,500	.604	32	.1259	35						42,700	0	0	∞	∞

TABLE V.—VALUES OF τ AND $\frac{1}{\pi} \sqrt{\frac{I}{E\tau}}$ FOR STAINLESS STEEL

$E=29,300,000$ lb. per sq. in.

P/A (lb. per sq. in.)	τ	Δ	$\frac{10^8}{\pi} \sqrt{\frac{I}{E\tau}}$ (in./lb. ^{1/2})	Δ	P/A (lb. per sq. in.)	τ	Δ	$\frac{10^8}{\pi} \sqrt{\frac{I}{E\tau}}$ (in./lb. ^{1/2})	Δ	P/A (lb. per sq. in.)	τ	Δ	$\frac{10^8}{\pi} \sqrt{\frac{I}{E\tau}}$ (in./lb. ^{1/2})	Δ
0	1	0	0.0621	0	42,000	0.834	15	0.0680	6	84,000	0.447	21	0.0628	23
2,000	1.000	2	.0621	0	44,000	.819	15	.0686	6	86,000	.426	21	.0651	25
4,000	.998	2	.0621	1	46,000	.804	15	.0692	7	88,000	.405	22	.0676	27
6,000	.996	3	.0622	1	48,000	.789	16	.0699	7	90,000	.383	22	.1003	30
8,000	.993	3	.0623	1	50,000	.773	16	.0706	8	92,000	.361	22	.1033	33
10,000	.990	5	.0624	1	52,000	.756	17	.0714	8	94,000	.339	22	.1066	37
12,000	.985	5	.0625	2	54,000	.739	17	.0722	9	96,000	.317	22	.1103	41
14,000	.980	6	.0627	2	56,000	.722	18	.0731	9	98,000	.295	23	.1144	47
16,000	.974	7	.0629	2	58,000	.704	18	.0740	10	100,000	.272	23	.1191	53
18,000	.967	7	.0631	2	60,000	.686	18	.0750	10	102,000	.249	23	.1244	61
20,000	.960	8	.0633	3	62,000	.668	19	.0760	11	104,000	.226	23	.1305	72
22,000	.952	9	.0636	3	64,000	.649	19	.0771	11	106,000	.203	23	.1377	85
24,000	.943	10	.0639	3	66,000	.630	19	.0782	12	108,000	.180	23	.1462	104
26,000	.933	10	.0642	4	68,000	.611	20	.0794	12	110,000	.157	23	.1566	130
28,000	.923	11	.0646	4	70,000	.591	20	.0807	14	112,000	.134	23	.1696	171
30,000	.912	12	.0650	4	72,000	.571	20	.0821	15	114,000	.111	23	.1867	237
32,000	.900	12	.0654	4	74,000	.551	20	.0836	16	116,000	.088	24	.2104	320
34,000	.888	12	.0658	5	76,000	.531	21	.0852	17	118,000	.064	24	.2464	546
36,000	.876	13	.0663	5	78,000	.510	21	.0869	18	120,000	.040	24	.3110	1783
38,000	.863	14	.0668	6	80,000	.489	21	.0887	20	122,000	.016	16	.4803	"
40,000	.849	15	.0674	6	82,000	.468	21	.0907	21	123,400	0	"	"	"

TABLE VI.—VALUES OF τ AND $\frac{1}{\pi} \sqrt{\frac{I}{E\tau}}$ FOR HEAT-TREATED CHROMIUM-MOLYBDENUM STEEL

$E=30,00,0000$ lb. per sq. in.

P/A (lb. per sq. in.)	τ	Δ	$\frac{10^8}{\pi} \sqrt{\frac{I}{E\tau}}$ (in./lb. ^{1/2})	Δ	P/A (lb. per sq. in.)	τ	Δ	$\frac{10^8}{\pi} \sqrt{\frac{I}{E\tau}}$ (in./lb. ^{1/2})	Δ	P/A (lb. per sq. in.)	τ	Δ	$\frac{10^8}{\pi} \sqrt{\frac{I}{E\tau}}$ (in./lb. ^{1/2})	Δ
0 to 108,900	1	0	0.0581	0	118,000	.982	5	.0589	2	129,000	.880	17	.0619	6
109,000	1.000	0	.0581	0	119,000	.977	6	.0593	2	130,000	.863	19	.0625	7
110,000	1.000	0	.0581	0	120,000	.971	6	.0590	2	131,000	.844	22	.0632	9
111,000	.999	1	.0581	1	121,000	.965	7	.0592	2	132,000	.822	25	.0641	10
112,000	.998	1	.0582	1	122,000	.958	8	.0594	2	133,000	.797	28	.0651	12
113,000	.996	2	.0582	0	123,000	.950	9	.0596	3	134,000	.769	34	.0663	15
114,000	.994	2	.0583	1	124,000	.941	9	.0599	3	135,000	.735	40	.0678	19
115,000	.992	3	.0583	0	125,000	.932	11	.0602	3	136,000	.695	50	.0697	27
116,000	.989	3	.0584	1	126,000	.921	11	.0606	4	137,000	.645	66	.0724	40
117,000	.980	4	.0585	1	127,000	.909	12	.0610	4	138,000	.579	101	.0764	76
					128,000	.895	14	.0614	4	139,000	.478	178	.0810	"
							15		5	140,000	0	478	"	"

COLUMN STRENGTH OF TUBES

TABLE VII.—VALUES OF s , t , AND t^2-s^2

$$s = \frac{\phi}{\sin \phi} - 1 \qquad t = 1 - \frac{\phi}{\tan \phi}$$

Interpolation for s , t , and t^2-s^2 when $0.99 < \frac{\phi}{\pi} < 1.01$ is not possible, and it will be sufficiently accurate to take $s = \frac{2\frac{\phi}{\pi} - 1}{1 - \frac{\phi}{\pi}}$, $t = \frac{1}{1 - \frac{\phi}{\pi}}$, and $t^2 - s^2 = \frac{4\frac{\phi}{\pi}}{1 - \frac{\phi}{\pi}}$. Similarly, interpolation

for s and t when $1.99 < \frac{\phi}{\pi} < 2.00$ is not possible, and then with sufficient accuracy $s = \frac{2}{\frac{\phi}{\pi} - 2}$ and $t = \frac{2}{\frac{\phi}{\pi}}$.

ϕ/π	ϕ	s	t	t^2-s^2	ϕ/π	ϕ	s	t	t^2-s^2
0	0	0	0	0	.87	2.73319	5.8820	7.3180	18.926
.01	.03142	.00016	.00033	.00000	.88	2.76460	6.6100	7.9326	21.342
.02	.06283	.00066	.00182	.00000	.89	2.79620	7.3542	8.7662	24.223
.03	.09425	.00148	.00296	.00001	.90	2.82743	8.1498	9.7019	27.709
.04	.12566	.00264	.00427	.00002	.91	2.85885	9.2471	10.840	32.002
.05	.15708	.00412	.00574	.00005	.92	2.89027	10.622	12.257	37.404
.06	.18850	.00595	.00737	.00011	.93	2.92188	12.395	14.071	44.392
.07	.21991	.00811	.01016	.00020	.94	2.95310	14.760	16.481	53.790
.08	.25133	.01061	.01314	.00033	.95	2.98451	18.078	19.843	66.936
.09	.28274	.01345	.01639	.00054	.96	3.01593	23.063	24.574	86.778
.10	.31416	.01664	.02002	.00082	.97	3.04734	31.351	33.238	119.95
.11	.34558	.02018	.02404	.00120	.98	3.07876	43.032	49.935	186.46
.12	.37699	.02409	.02846	.00171	.99	3.11018	98.016	99.967	356.29
.13	.40841	.02835	.03429	.00236	±∞	±∞	±∞	±∞	±∞
.14	.43982	.03298	.04154	.00315	L.00	3.14159	±∞	±∞	±∞
.15	.47124	.03799	.05021	.00407	L.01	3.17301	-102.02	-99.967	-414.04
.16	.50265	.04339	.06030	.00514	L.02	3.20442	-52.034	-49.933	-214.20
.17	.53407	.04917	.07281	.00639	L.03	3.23584	-35.354	-33.232	-147.70
.18	.56549	.05535	.08784	.00780	L.04	3.26726	-27.069	-24.563	-114.64
.19	.59690	.06195	.10539	.01037	L.05	3.29867	-22.057	-19.827	-94.708
.20	.62832	.06896	.12546	.01322	L.06	3.33009	-18.772	-16.457	-81.547
.21	.65973	.07640	.14803	.01635	L.07	3.36150	-16.410	-14.039	-73.196
.22	.69115	.08429	.17410	.02077	L.08	3.39292	-14.643	-12.215	-65.227
.23	.72257	.09263	.20377	.02657	L.09	3.42434	-13.274	-10.787	-60.847
.24	.75398	.10143	.23704	.03376	L.10	3.45575	-12.183	-9.6357	-58.580
.25	.78540	.11072	.27391	.04245	L.11	3.48717	-11.296	-8.6860	-62.121
.26	.81681	.12051	.31438	.05266	L.12	3.51858	-10.558	-7.8889	-64.271
.27	.84823	.13081	.35945	.06449	L.13	3.55000	-9.9857	-7.2036	-65.887
.28	.87965	.14164	.40912	.07792	L.14	3.58142	-9.4114	-6.6109	-66.871
.29	.91106	.15302	.46339	.09295	L.15	3.61283	-8.9579	-6.0906	-67.150
.30	.94248	.16497	.52226	.01071	L.16	3.64425	-8.5645	-5.6259	-66.829
.31	.97389	.17751	.58573	.02283	L.17	3.67566	-8.2308	-5.2152	-65.852
.32	L.00531	.19066	.65480	.03940	L.18	3.70708	-7.9184	-4.8414	-64.221
.33	L.03673	.20446	.72947	.06053	L.19	3.73850	-7.6511	-4.5010	-62.881
.34	L.06814	.21891	.80974	.08632	L.20	3.76991	-7.4138	-4.1833	-61.817
.35	L.09956	.23406	.89561	.11686	L.21	3.80133	-7.2021	-3.9006	-60.996
.36	L.13097	.24993	.98708	.15225	L.22	3.83274	-7.0129	-3.6330	-60.382
.37	L.16239	.26656	1.09415	.19250	L.23	3.86416	-6.8432	-3.3830	-60.004
.38	L.19381	.28397	1.21682	.23761	L.24	3.89557	-6.6907	-3.1484	-59.854
.39	L.22522	.30221	1.35509	.28767	L.25	3.92699	-6.5536	-2.9270	-59.882
.40	L.25664	.32131	1.50886	.34268	L.26	3.95841	-6.4301	-2.7179	-59.964
.41	L.28805	.34131	1.67913	.40265	L.27	3.98982	-6.3190	-2.5175	-60.092
.42	L.31947	.36227	1.86590	.46758	L.28	4.02124	-6.2189	-2.3267	-60.261
.43	L.35088	.38422	2.06917	.53747	L.29	4.05265	-6.1289	-2.1436	-60.469
.44	L.38230	.40717	2.28994	.61232	L.30	4.08407	-6.0482	-1.9673	-60.711
.45	L.41372	.43114	2.52821	.69213	L.31	4.11549	-5.9769	-1.7989	-61.033
.46	L.44513	.45612	2.78408	.77690	L.32	4.14690	-5.9155	-1.6317	-61.438
.47	L.47655	.48211	3.05755	.86663	L.33	4.17832	-5.8543	-1.4711	-61.921
.48	L.50796	.50910	3.34962	.96132	L.34	4.20973	-5.8040	-1.3143	-62.483
.49	L.53938	.53709	3.66029	1.06197	L.35	4.24115	-5.7600	-1.1610	-63.129
.50	L.57080	.56608	4.00056	1.16860	L.36	4.27257	-5.7220	-1.0105	-63.864
.51	L.60221	.59607	4.37043	1.28121	L.37	4.30398	-5.6897	-0.8625	-64.682
.52	L.63363	.62706	4.77090	1.40080	L.38	4.33540	-5.6625	-0.7165	-65.588
.53	L.66504	.65905	5.20297	1.52737	L.39	4.36681	-5.6402	-0.5721	-66.587
.54	L.69646	.69204	5.67654	1.66094	L.40	4.39823	-5.6229	-0.4291	-67.684
.55	L.72788	.72603	6.19161	1.80251	L.41	4.42964	-5.6106	-0.2869	-68.884
.56	L.75929	.75918	6.74818	1.95208	L.42	4.46106	-5.6033	-0.1454	-70.194
.57	L.79071	.79207	7.34625	2.10965	L.43	4.49247	-5.6009	-0.0042	-71.629
.58	L.82212	.82123	7.98582	2.27522	L.44	4.52389	-5.6035	0.1270	-73.194
.59	L.85354	.85018	8.66689	2.44879	L.45	4.55531	-5.6111	0.2785	-74.894
.60	L.88495	.88196	9.38946	2.63036	L.46	4.58673	-5.6237	0.4506	-76.733
.61	L.91637	.91037	10.15353	2.81993	L.47	4.61814	-5.6413	0.6435	-78.716
.62	L.94779	.94949	10.95910	3.01750	L.48	4.64956	-5.6639	0.7076	-80.848
.63	L.97920	.98156	11.80517	3.22307	L.49	4.68097	-5.6915	0.8529	-83.126
.64	L.101062	1.00423	12.69174	3.43664	L.50	4.71239	-5.7241	1.0	-85.655
.65	L.104504	1.04840	13.61881	3.65821	L.51	4.74380	-5.7617	1.1491	-88.439
.66	L.107546	1.09357	14.58638	3.88778	L.52	4.77522	-5.8043	1.3004	-91.484
.67	L.110188	1.13974	15.59445	4.12535	L.53	4.80663	-5.8519	1.4544	-94.800
.68	L.112430	1.18691	16.64302	4.37092	L.54	4.83805	-5.9045	1.6112	-98.403
.69	L.114272	1.23408	17.73209	4.62449	L.55	4.86947	-5.9621	1.7712	-102.300
.70	L.115714	1.28125	18.86166	4.88506	L.56	4.90089	-6.0247	1.9349	-106.500
.71	L.116756	1.32842	20.03173	5.15263	L.57	4.93231	-6.0923	2.1025	-111.017
.72	L.117498	1.37559	21.25180	5.42720	L.58	4.96373	-6.1649	2.2745	-115.858
.73	L.117940	1.42276	22.52187	5.70877	L.59	4.99515	-6.2425	2.4512	-121.031
.74	L.118082	1.46993	23.84194	5.99734	L.60	5.02657	-6.3251	2.6332	-126.552
.75	L.117924	1.51710	25.21201	6.29291	L.61	5.05800	-6.4127	2.8210	-132.439
.76	L.117466	1.56427	26.63208	6.59548	L.62	5.08942	-6.5053	3.0150	-138.698
.77	L.116708	1.61144	28.10215	6.90505	L.63	5.12084	-6.6029	3.2160	-145.337
.78	L.115650	1.65861	29.62222	7.22162	L.64	5.15226	-6.7055	3.4244	-152.372
.79	L.114292	1.70578	31.19229	7.54519	L.65	5.18368	-6.8131	3.6412	-159.819
.80	L.112634	1.75295	32.81236	7.87576	L.66	5.21510	-6.9257	3.8670	-167.684
.81	L.110576	1.79912	34.48243	8.21333	L.67	5.24652	-7.0433	4.1027	-176.074
.82	L.108118	1.84529	36.20250	8.55790	L.68	5.27794	-7.1659	4.3484	-185.003
.83	L.105260	1.89146	37.97257	8.90947	L.69	5.30936	-7.2935	4.6041	-194.486
.84	L.102002	1.93763	39.79264	9.26704	L.70	5.34078	-7.4261	4.8698	-204.539
.85	L.98344	1.98380	41.66271	9.63061	L.71	5.37220	-7.5637	5.1455	-215.179
.86	L.94186	2.02997	43.58278	10.00018	L.72	5.40362	-7.7063	5.4302	-226.420

TABLE VII.—VALUES OF s , t , AND t^2-s^2 —Continued

ϕ/π	ϕ	s	t	t^2-s^2	ϕ/π	ϕ	s	t	t^2-s^2
1.73	5.43496	-8.2455	5.7916	-34.447	1.87	5.87478	-15.792	14.570	-30.945
1.74	5.46637	-8.4988	6.1333	-34.612	1.88	5.90619	-17.044	15.917	-37.136
1.75	5.49779	-8.7750	6.4978	-34.780	1.89	5.93761	-18.529	17.492	-37.328
1.76	5.52920	-9.0772	6.8880	-34.950	1.90	5.96903	-20.316	19.371	-37.520
1.77	5.56062	-9.4085	7.3073	-35.123	1.91	6.00044	-22.508	21.054	-37.713
1.78	5.59203	-9.7729	7.7596	-35.297	1.92	6.03186	-25.256	24.403	-37.907
1.79	5.62345	-10.175	8.2497	-35.474	1.93	6.06327	-28.795	28.126	-38.102
1.80	5.65487	-10.621	8.7823	-35.652	1.94	6.09469	-33.628	32.949	-38.297
1.81	5.68628	-11.116	9.3671	-35.832	1.95	6.12611	-40.161	39.079	-38.494
1.82	5.71770	-11.671	10.010	-36.014	1.96	6.15752	-50.129	49.742	-38.690
1.83	5.74911	-12.294	10.721	-36.198	1.97	6.18894	-64.764	66.472	-38.887
1.84	5.78053	-13.999	11.516	-36.383	1.98	6.22035	-100.07	99.570	-39.085
1.85	5.81195	-13.802	12.407	-36.569	1.99	6.25177	-200.03	199.93	-39.281
1.86	5.84336	-14.724	13.415	-36.757	2.00	6.28319	$-\infty$	∞	-39.478